



US00D695154S

(12) **United States Design Patent**
Buckan

(10) **Patent No.:** **US D695,154 S**

(45) **Date of Patent:** **** Dec. 10, 2013**

(54) **MOTORCYCLE, TOY, OR REPLICA
THEREOF**

D587,172 S * 2/2009 Buckan et al. D12/110
D588,960 S * 3/2009 Buckan et al. D12/110
D601,061 S * 9/2009 Heinrich et al. D12/110

(75) Inventor: **Alexander Buckan**, Groebenzell (DE)

FOREIGN PATENT DOCUMENTS

(73) Assignee: **Bayerische Motoren Werke
Aktiengesellschaft**, Munich (DE)

EM 000106513-0001 12/2004
EM 000360102-0001 1/2006

(**) Term: **14 Years**

* cited by examiner

(21) Appl. No.: **29/430,272**

Primary Examiner — Susan M Lee

Assistant Examiner — Linda Brooks

(22) Filed: **Aug. 23, 2012**

(74) *Attorney, Agent, or Firm* — Crowell & Moring LLP

(51) **LOC (9) Cl.** **12-11**

(57) **CLAIM**

The ornamental design for a motorcycle, toy, or replica thereof, as shown and described.

(52) **U.S. Cl.**

USPC **D12/110**

DESCRIPTION

(58) **Field of Classification Search**

USPC D12/110; D21/432, 458; 446/440;
280/827, 828

See application file for complete search history.

FIG. 1 is a left, front perspective view of a motorcycle, toy, or replica thereof according to my design;
FIG. 2 is a left, rear perspective view thereof;
FIG. 3 is a right, front perspective view thereof;
FIG. 4 is a right, rear perspective view thereof;
FIG. 5 is a left side view thereof;
FIG. 6 is a right side view thereof;
FIG. 7 is a front view thereof;
FIG. 8 is a rear view thereof;
FIG. 9 is a top view thereof; and,
FIG. 10 is a bottom view thereof.
The broken lines illustrate unclaimed structure.

(56) **References Cited**

U.S. PATENT DOCUMENTS

D422,244 S * 4/2000 Heinrich et al. D12/110
D500,463 S 1/2005 Heinrich et al.
D519,883 S * 5/2006 Robb D12/110
D531,089 S 10/2006 Heinrich et al.
D548,649 S * 8/2007 Heinrich et al. D12/110
D549,137 S * 8/2007 Heinrich et al. D12/110
D565,472 S * 4/2008 Hohdorf et al. D12/110

1 Claim, 9 Drawing Sheets

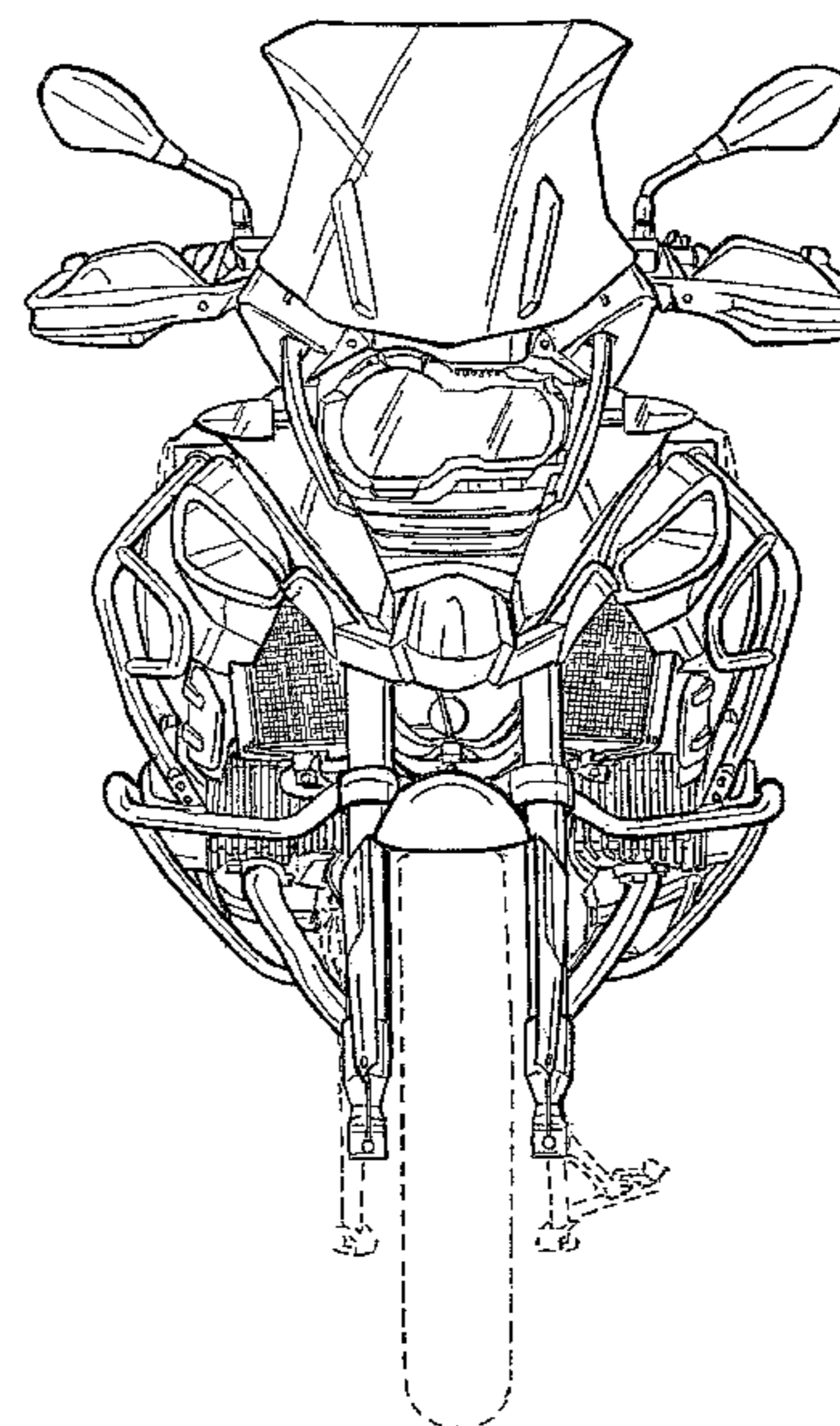
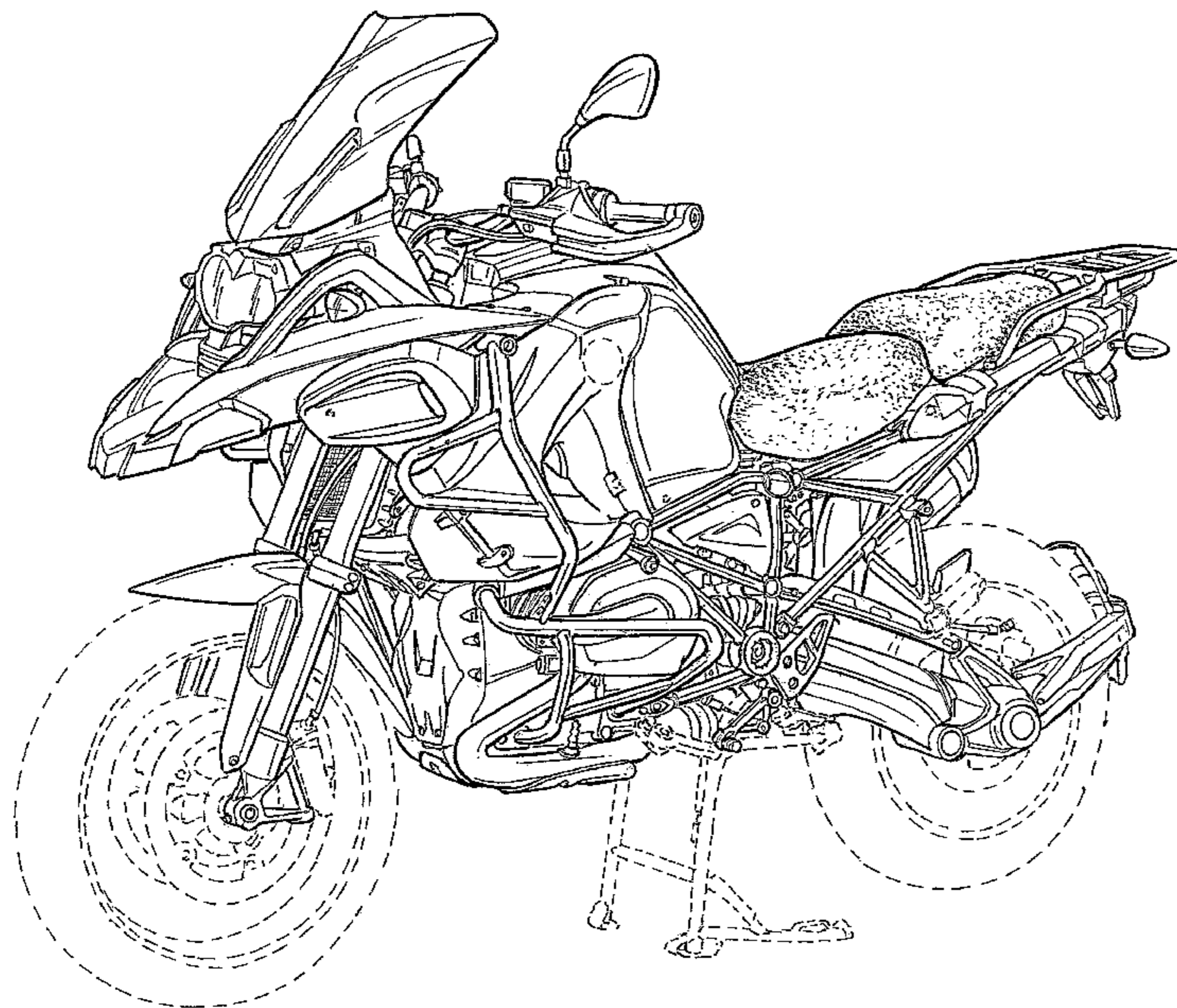

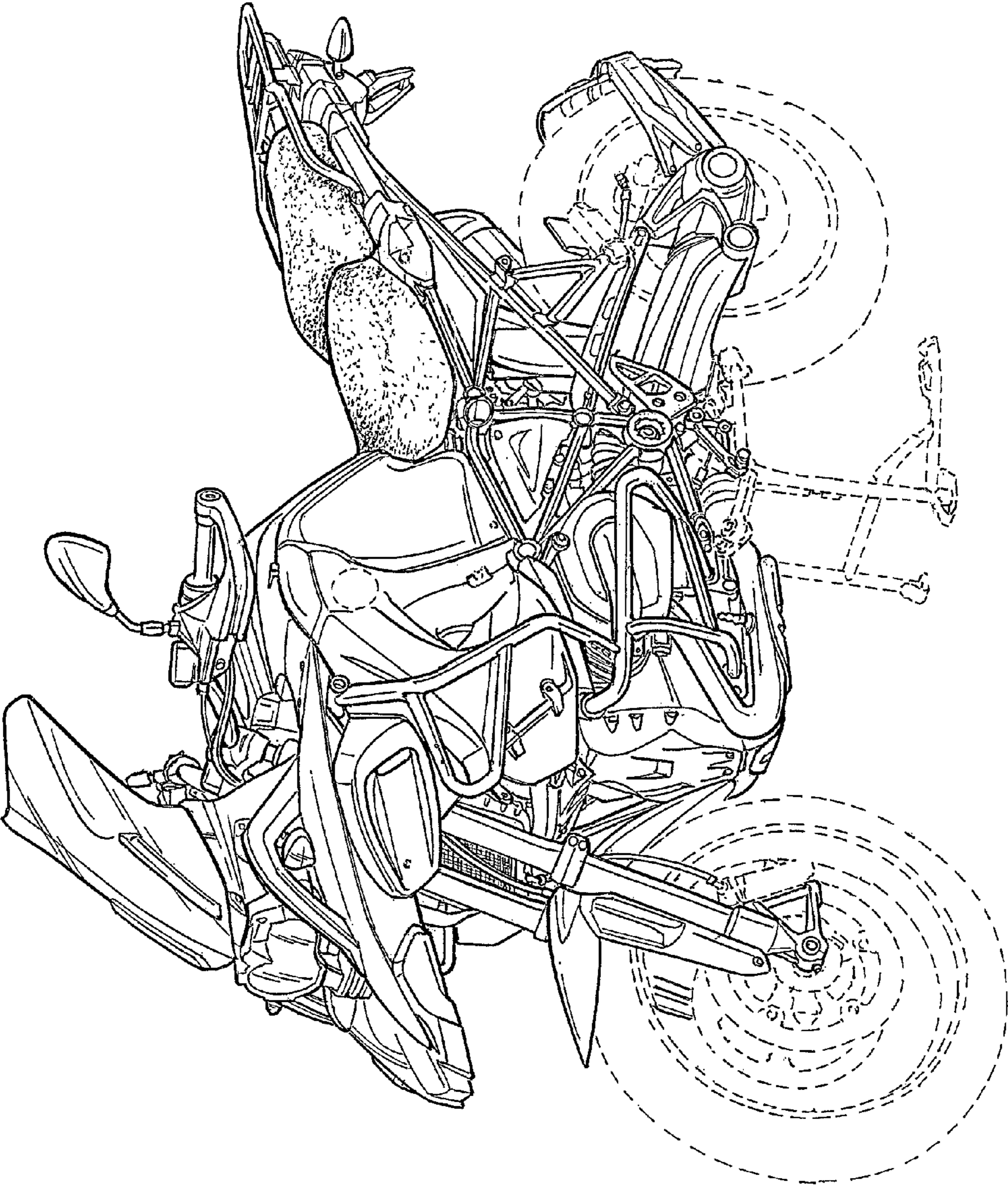

FIG. 1

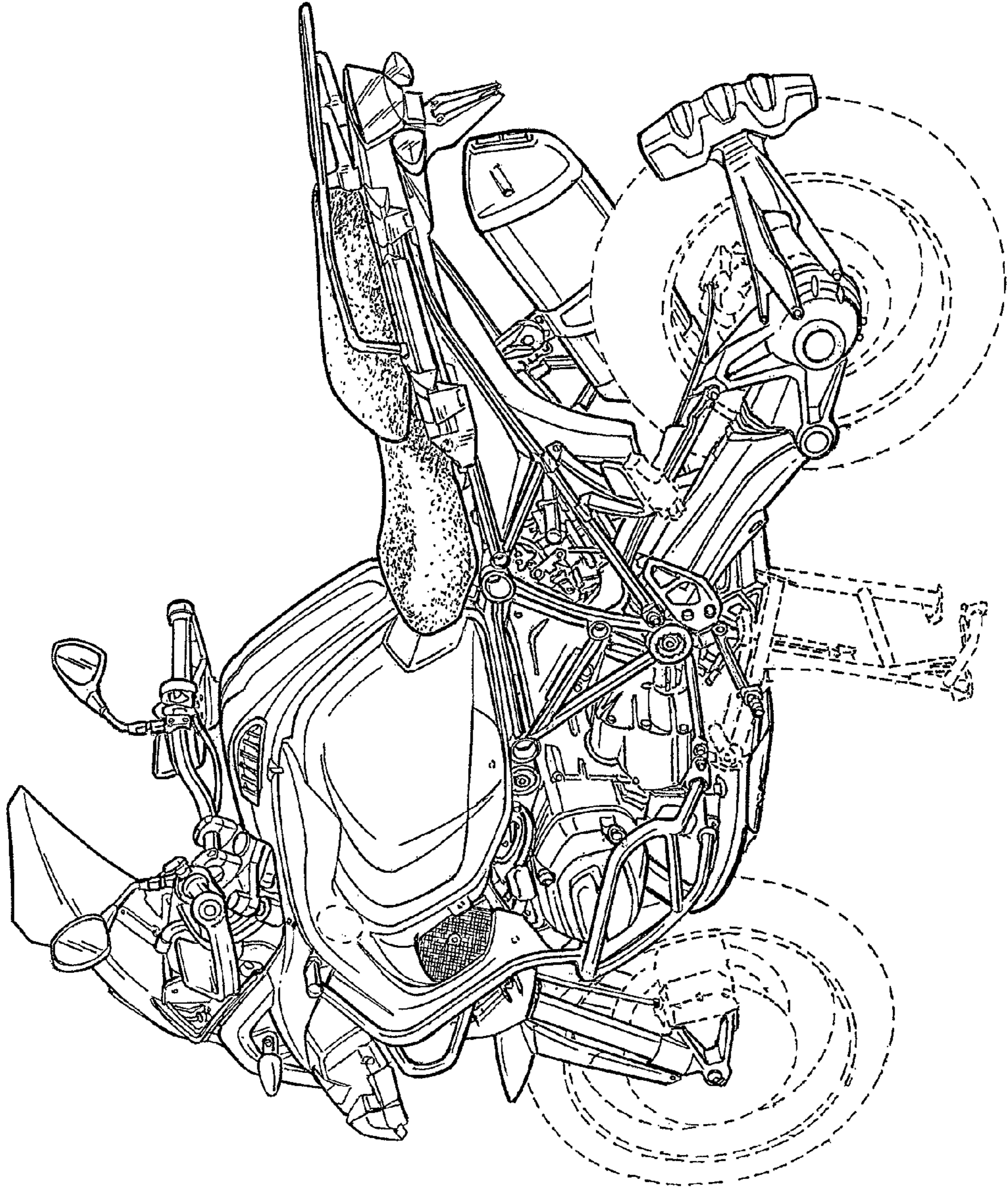

FIG. 2

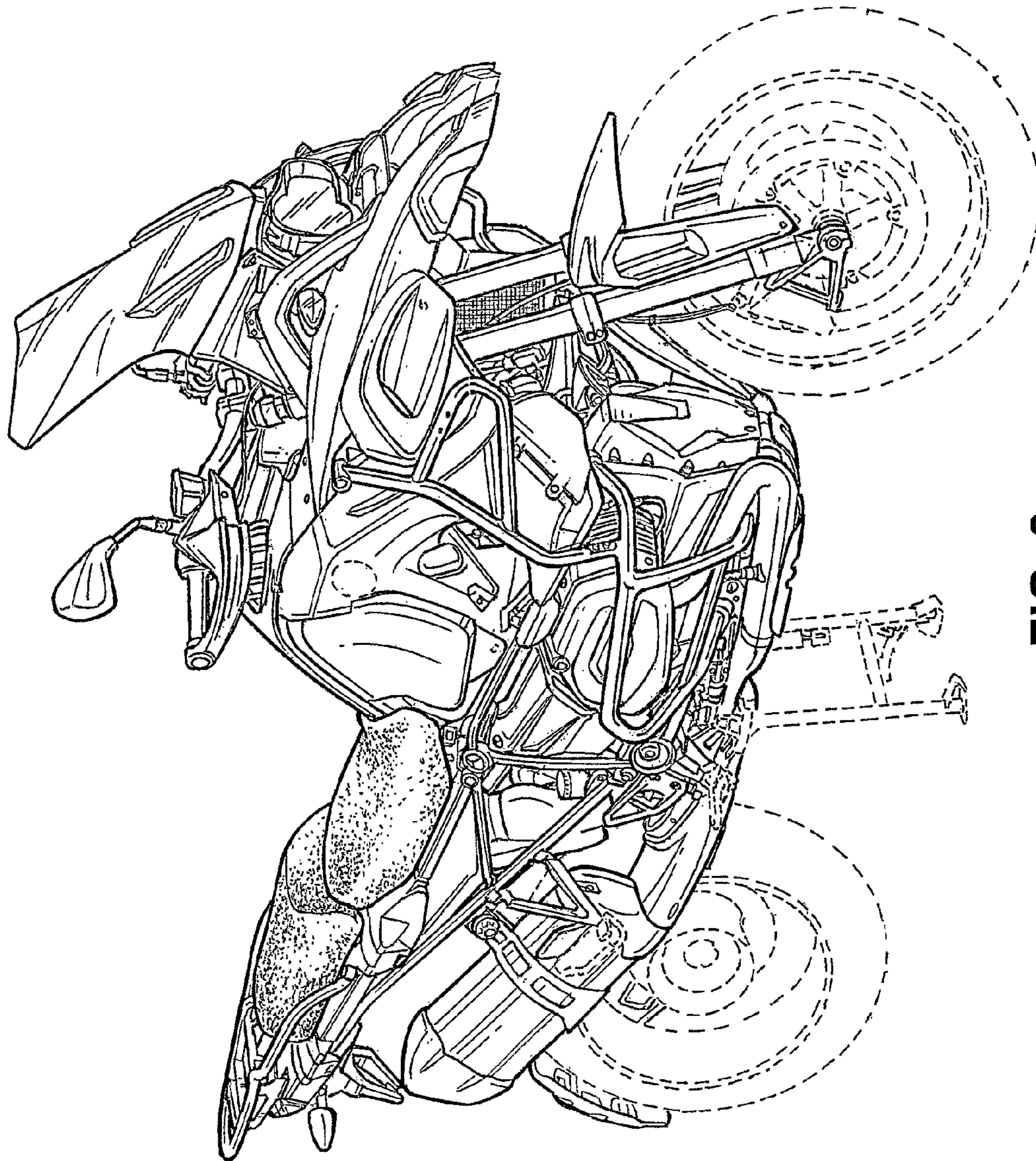

FIG. 3

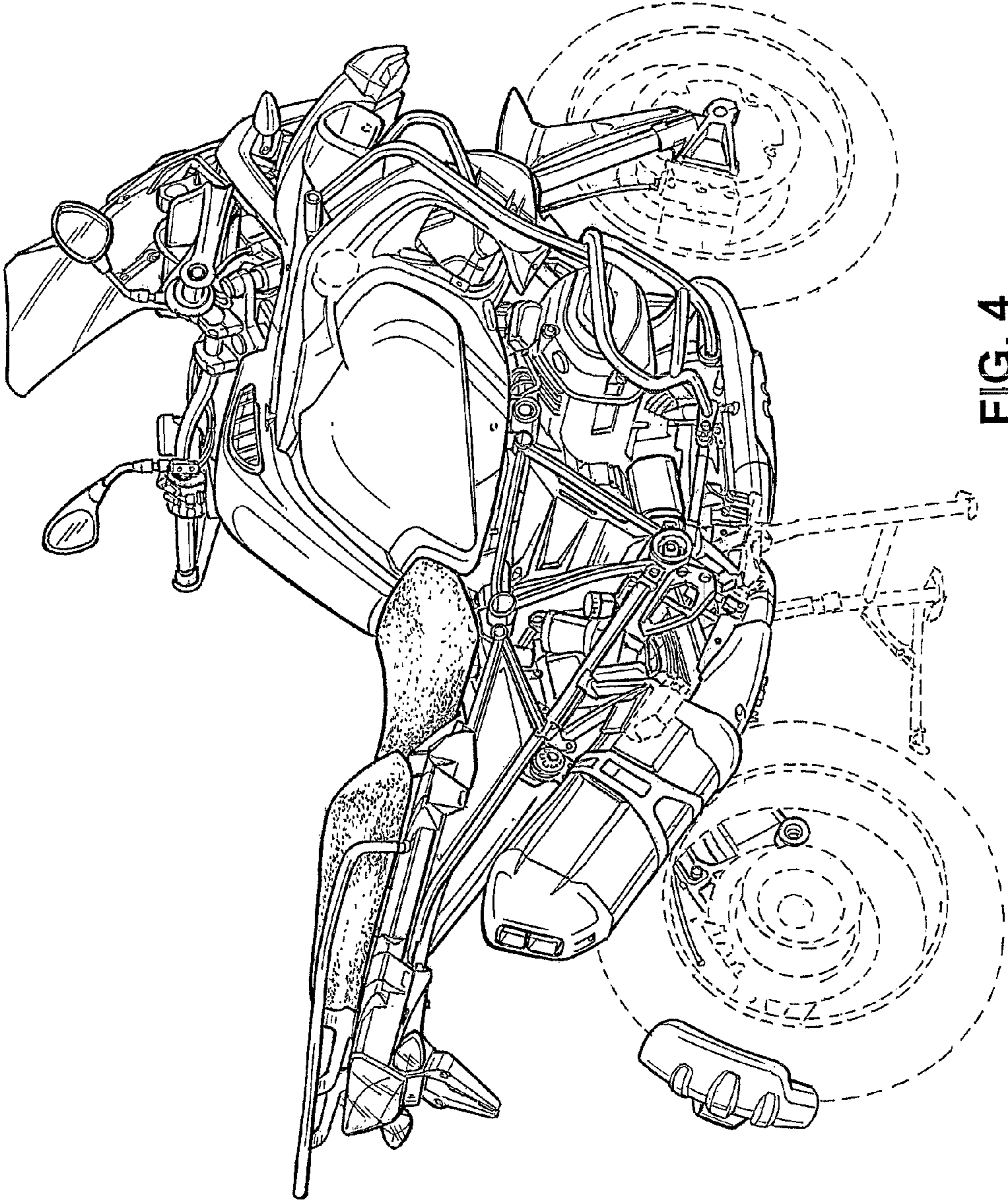

FIG. 4

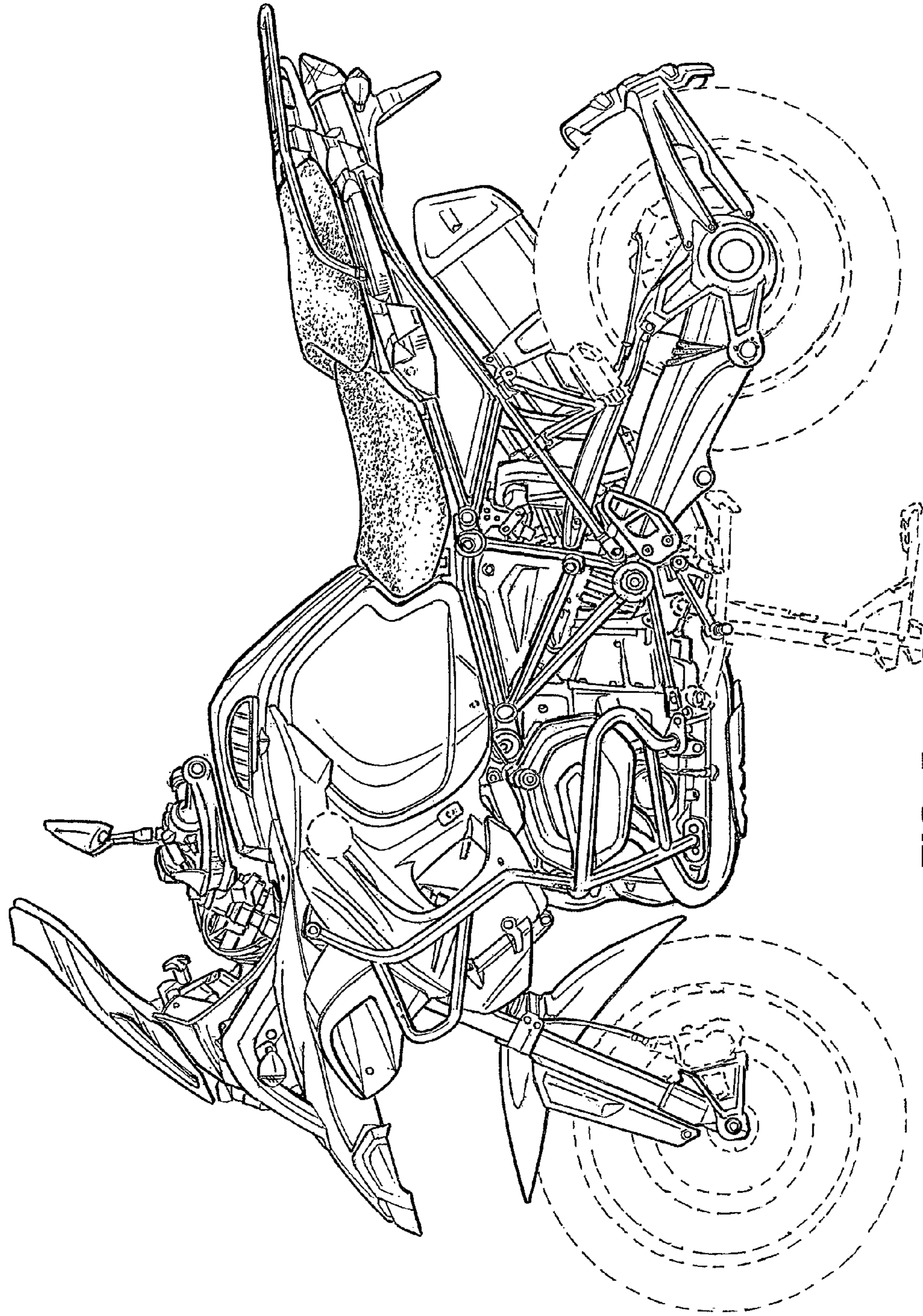

FIG. 5

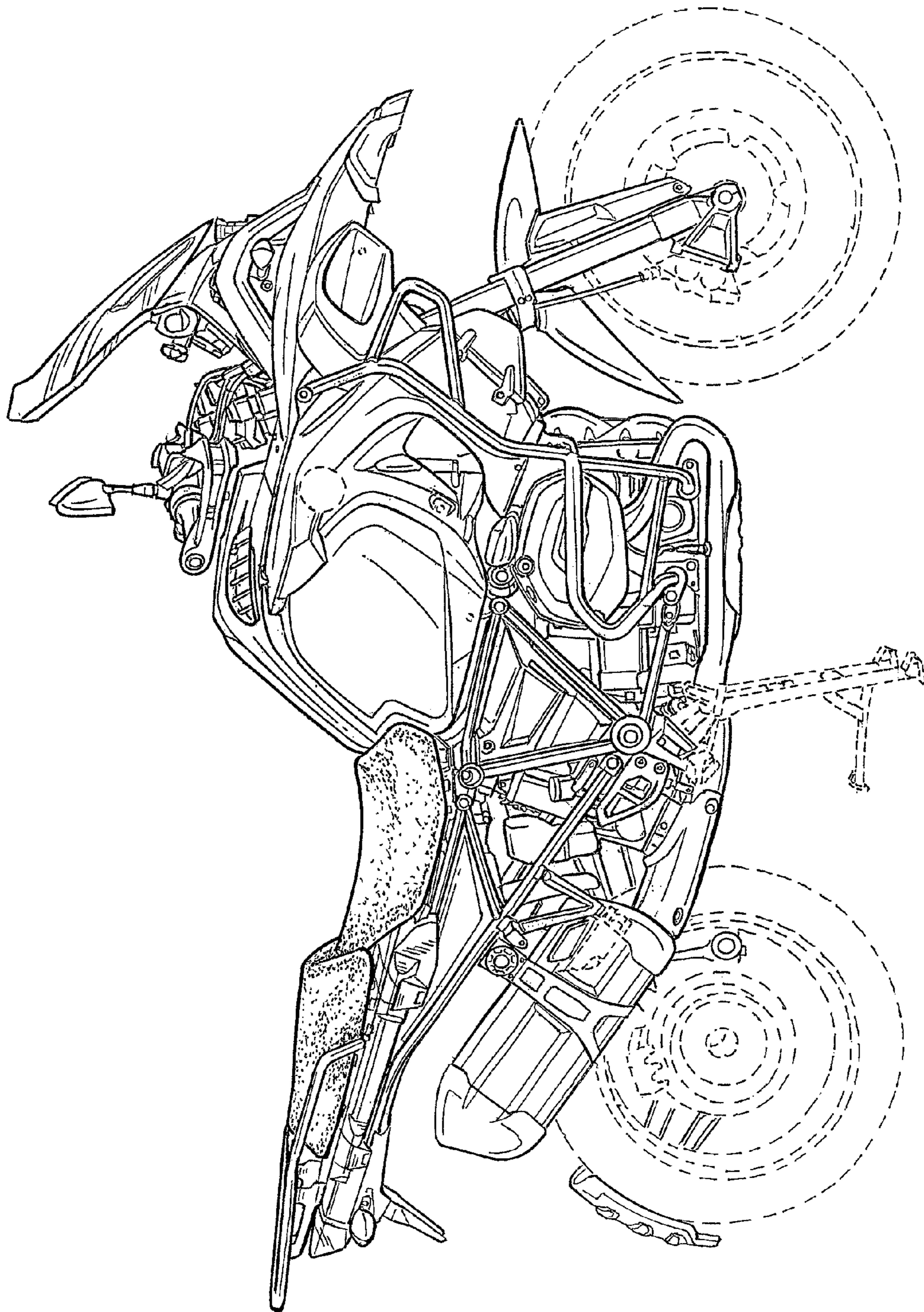

FIG. 6

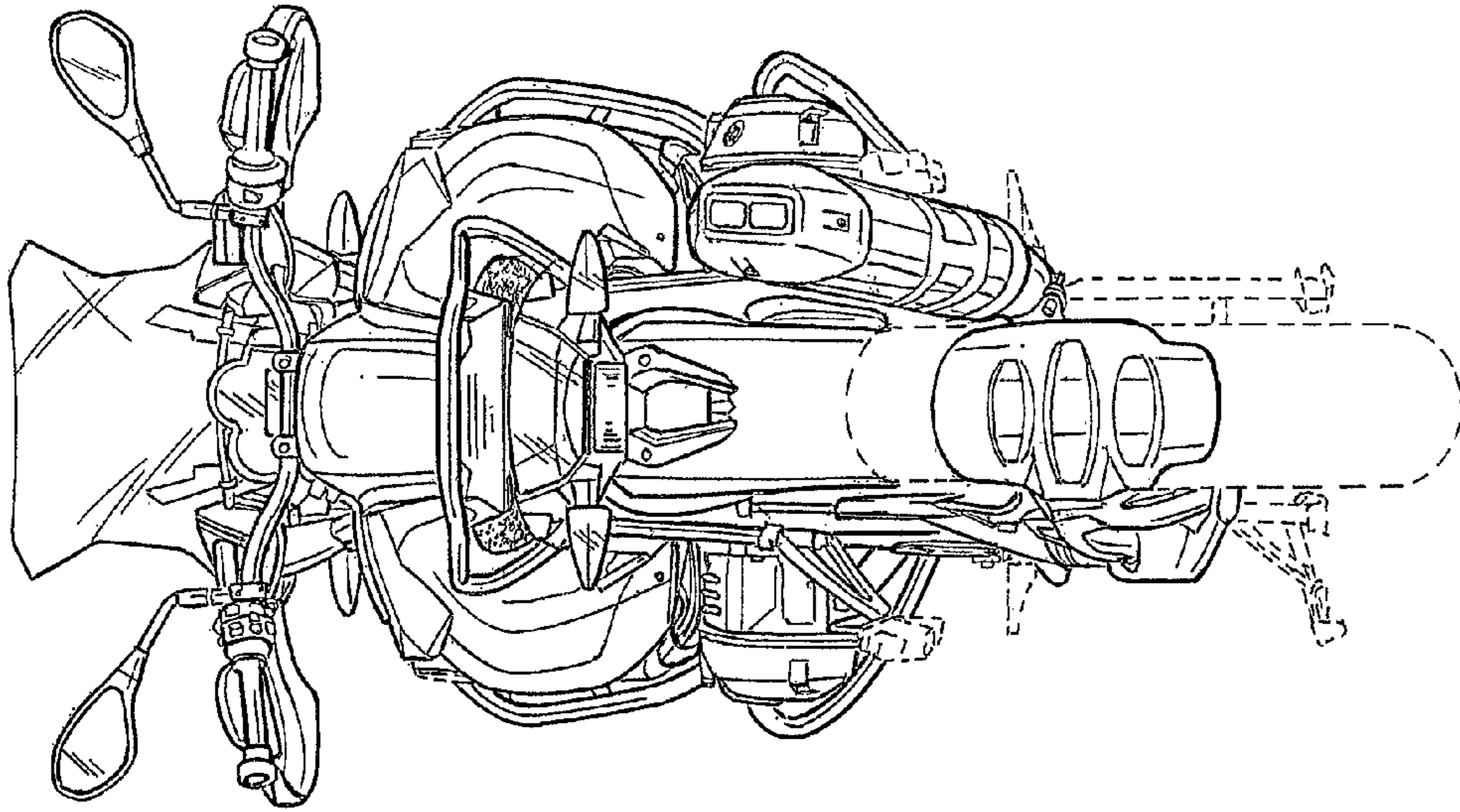

FIG. 8

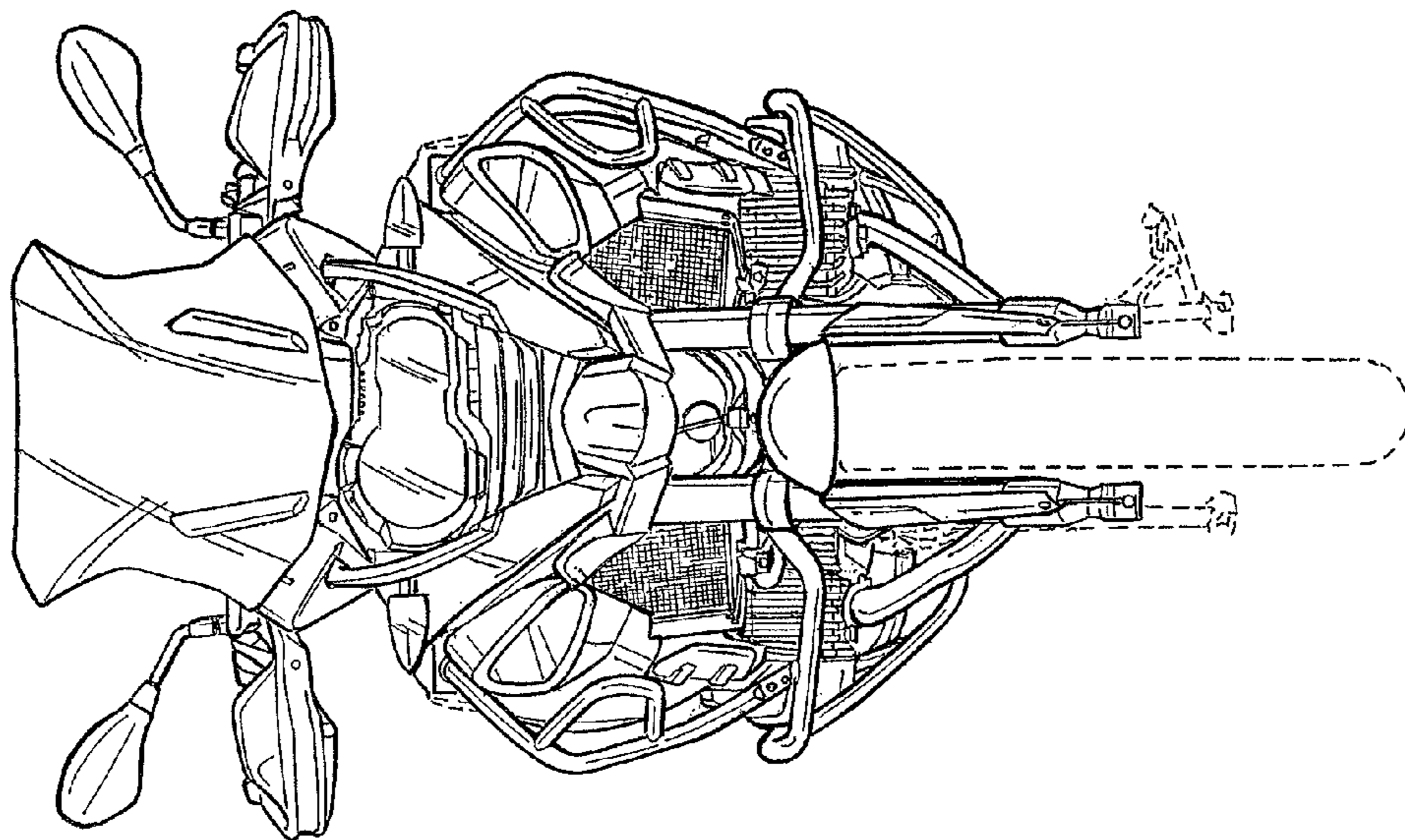

FIG. 7

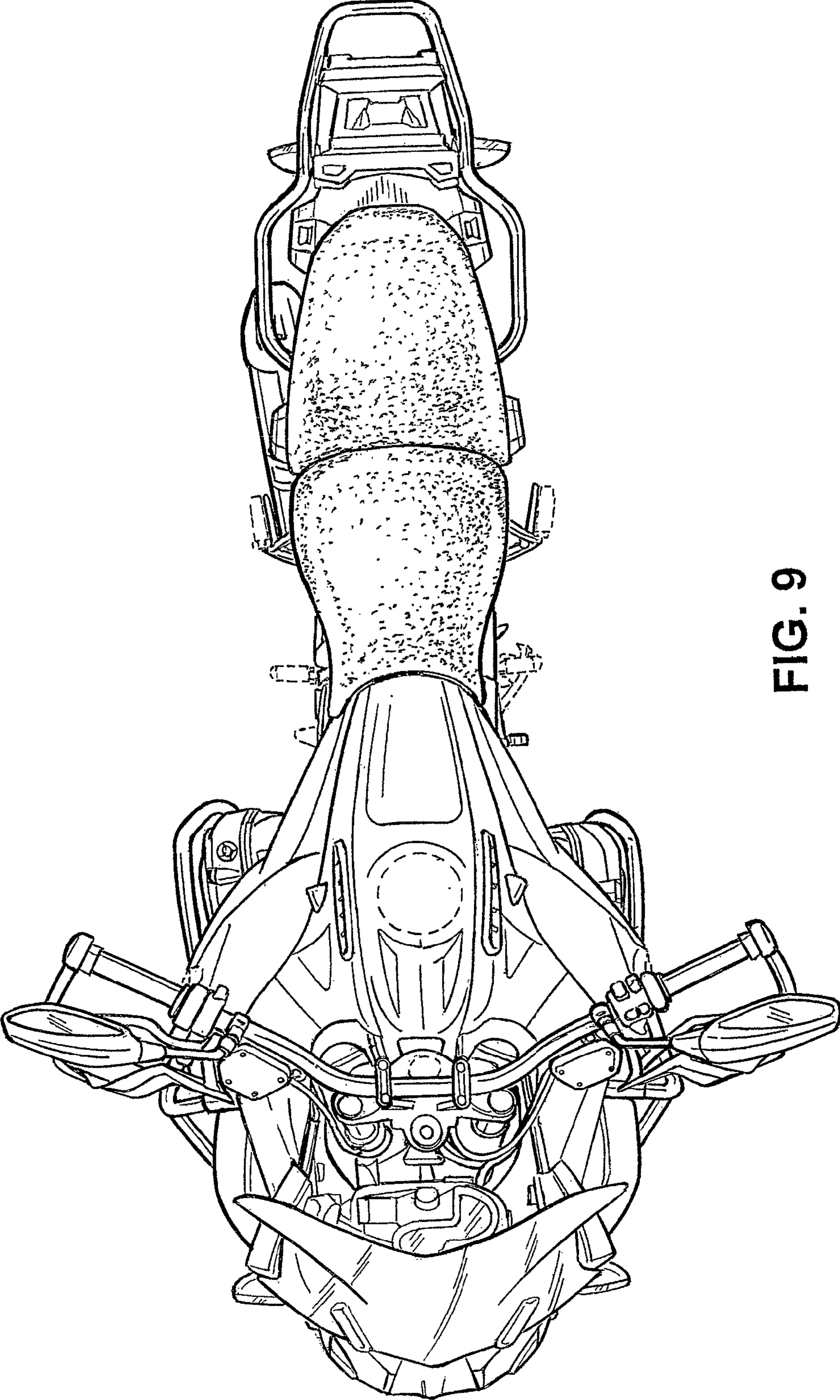

FIG. 9

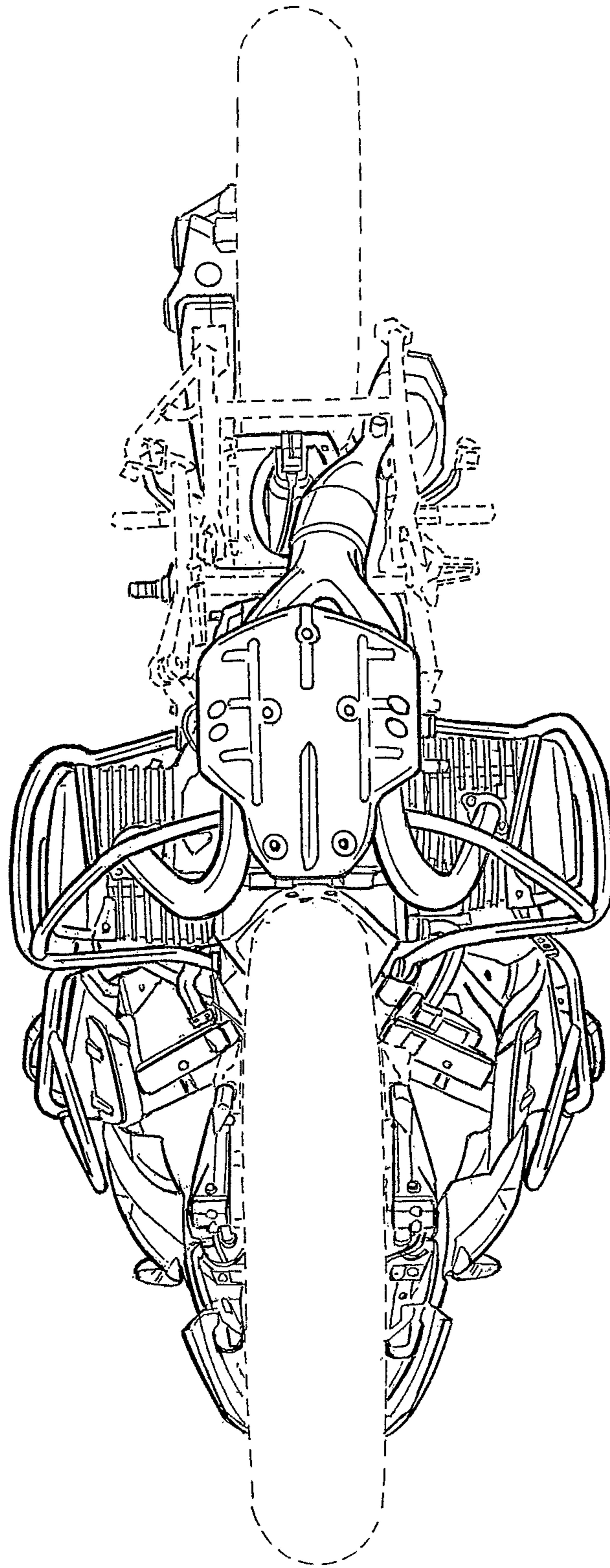

FIG. 10