



US00D695143S

(12) **United States Design Patent**  
**Solow**

(10) **Patent No.:** **US D695,143 S**

(45) **Date of Patent:** **\*\* Dec. 10, 2013**

(54) **HORN COVER**

(75) Inventor: **Stanley Solow**, Plainview, NY (US)

(73) Assignee: **Wolo Mfg. Corp.**, Deer Park, NY (US)

(\*\*) Term: **14 Years**

(21) Appl. No.: **29/402,821**

(22) Filed: **Sep. 28, 2011**

(51) **LOC (9) Cl.** ..... **10-05**

(52) **U.S. Cl.**  
USPC ..... **D10/121**

(58) **Field of Classification Search**  
USPC ..... D10/104.1, 120, 121; D26/123;  
280/727; 369/286  
See application file for complete search history.

(56) **References Cited**

**U.S. PATENT DOCUMENTS**

D225,380	S	*	12/1972	Sanger et al.	.....	D10/121
D238,505	S	*	1/1976	Nagel	.....	D26/123
2003/0227863	A1	*	12/2003	Usami	.....	369/286
2008/0238043	A1	*	10/2008	Chlystek	.....	280/727

\* cited by examiner

*Primary Examiner* — George D Kirschbaum

(74) *Attorney, Agent, or Firm* — Andrew F. Young, Esq.;  
Lackebach Siegel, LLP

(57) **CLAIM**

The ornamental design for a horn cover, as shown and described.

**DESCRIPTION**

FIG. 1 is a front perspective view of a horn cover showing our new design.

FIG. 2 is a rear perspective view of FIG. 1.

FIG. 3 is a front elevational view of FIG. 1.

FIG. 4 is a rear elevated view of FIG. 1.

FIG. 5 is a left side elevation view of FIG. 1.

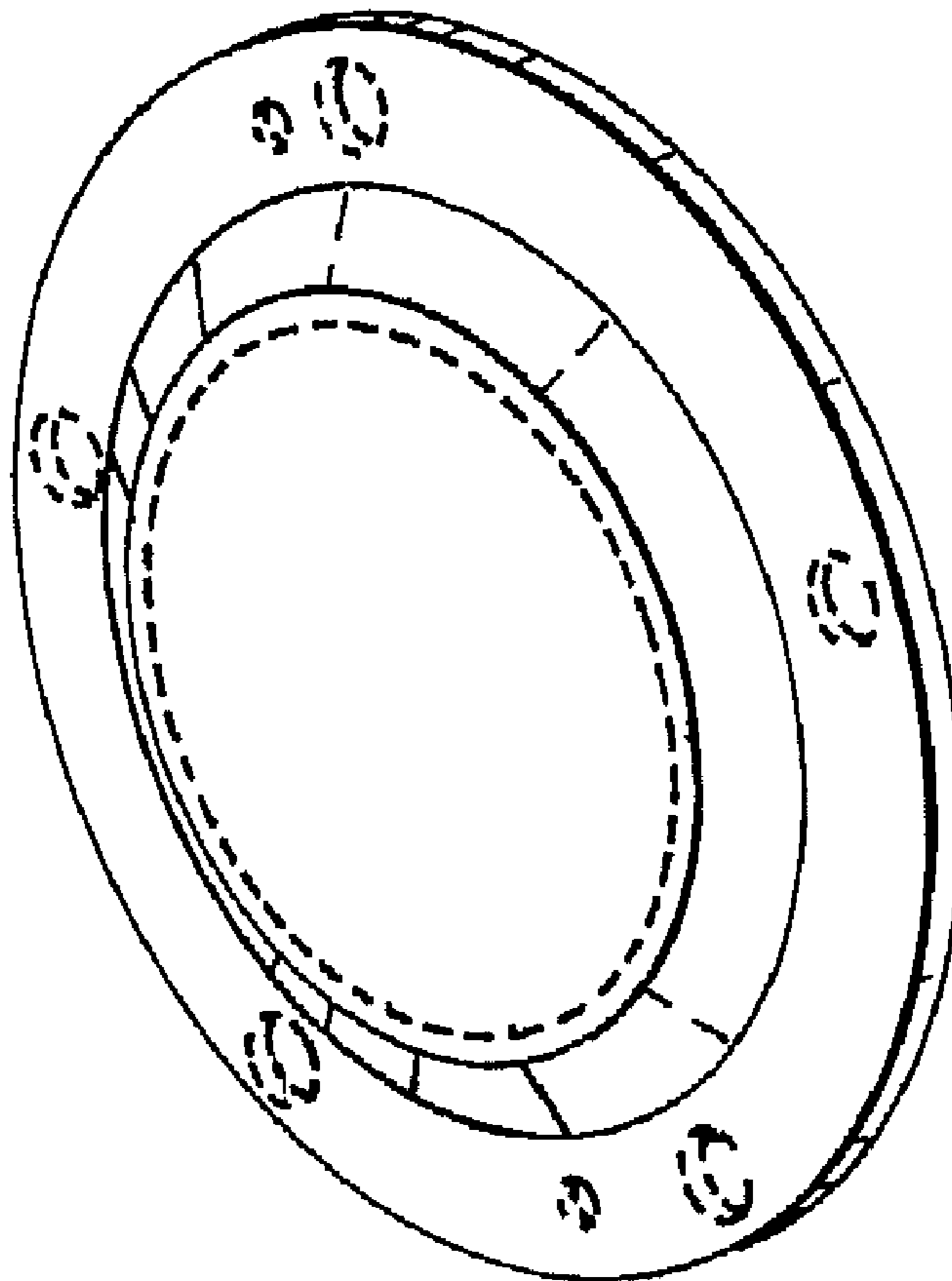
FIG. 6 is a top plan view of FIG. 1.

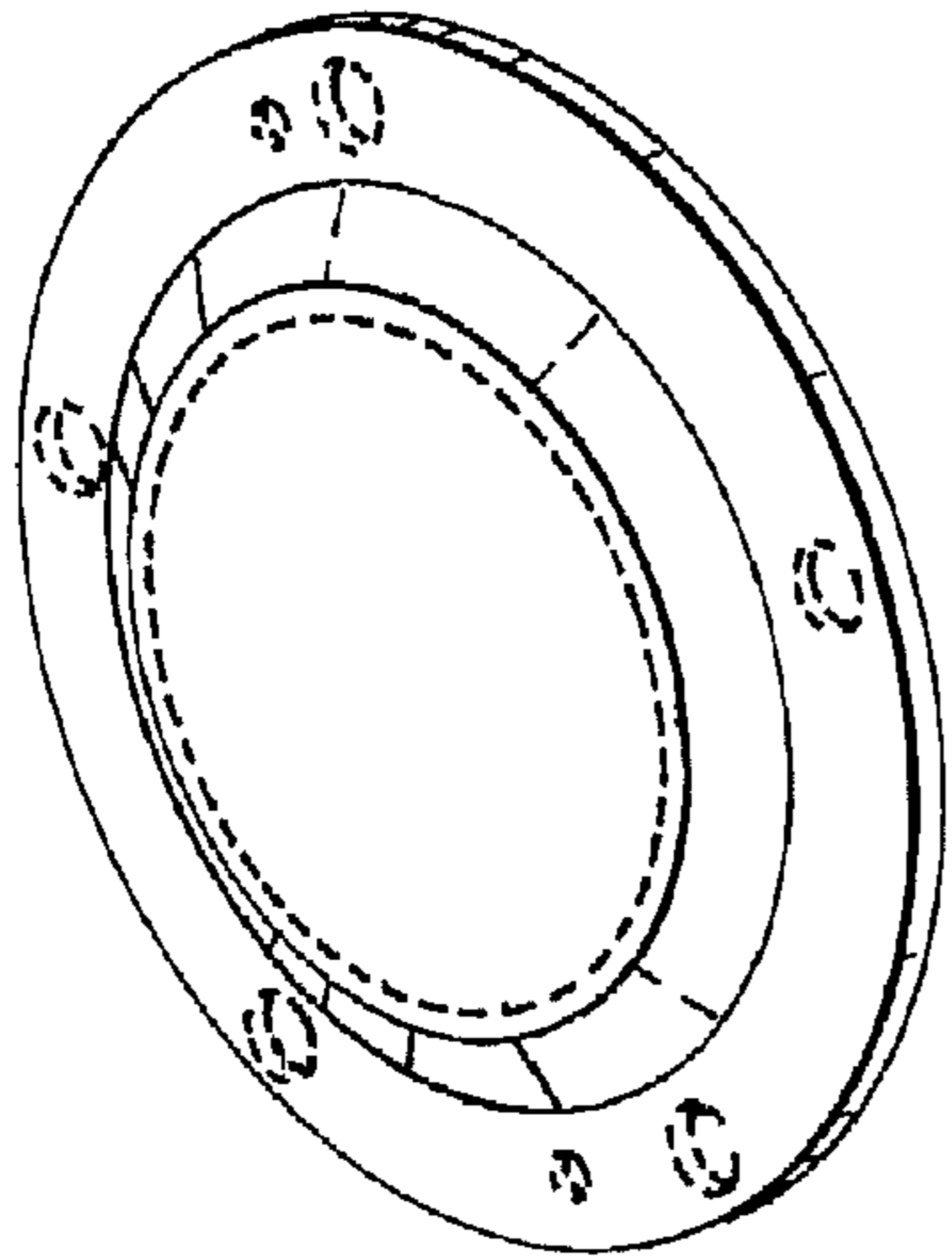
FIG. 7 is bottom plan view of FIG. 1; and,

FIG. 8 is a right side elevation view of FIG. 1.

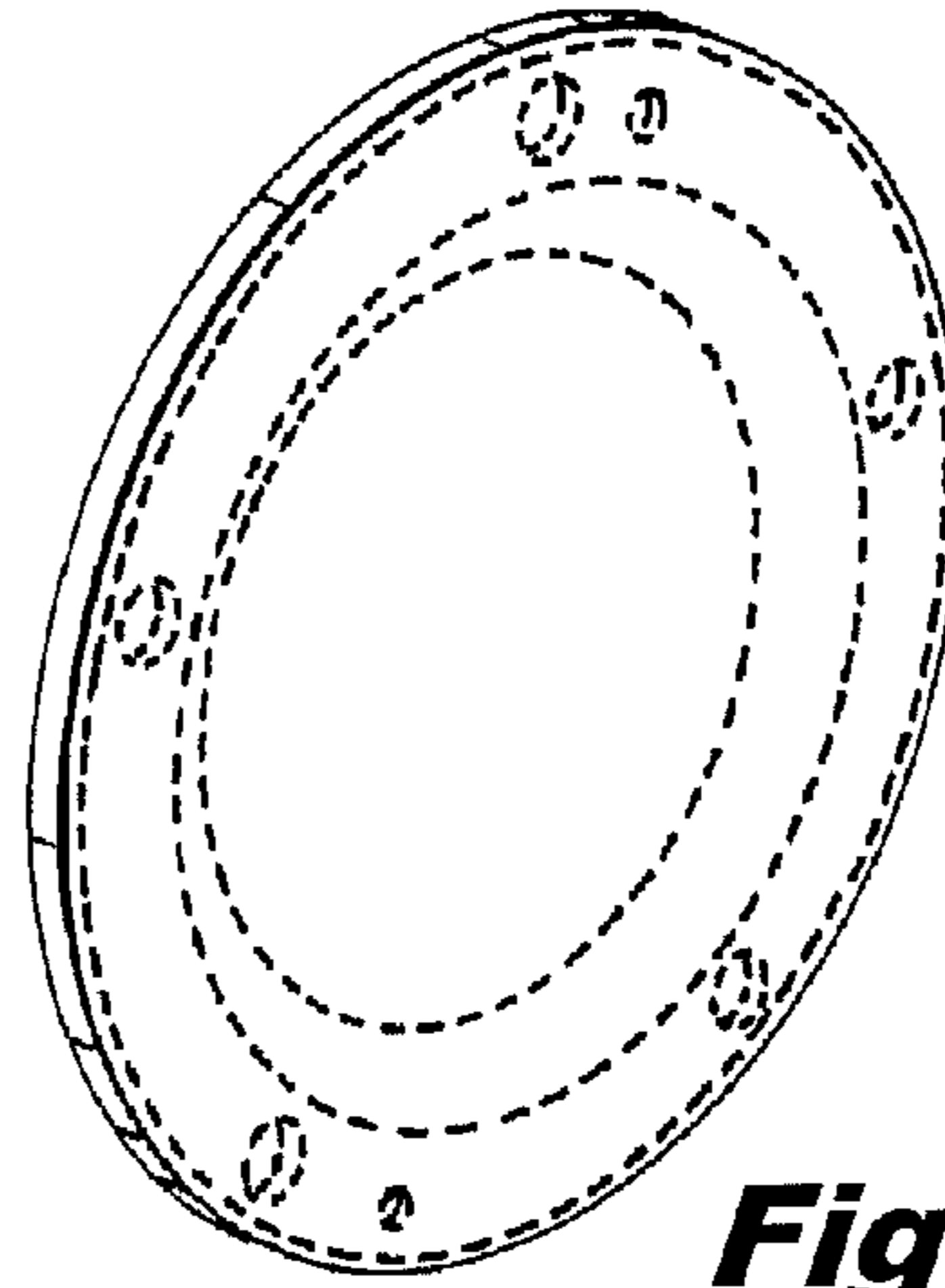
No claim is made to the rear portion of the horn cover, or the front central portion, as shown by the use of dashed lines. The portions shown in FIGS. 1-4 in dashed lines, including front and rear portions and perimeter flange openings, are not claimed and are shown for illustration purposes only, and do not contribute a part of the claimed design.

**1 Claim, 1 Drawing Sheet**

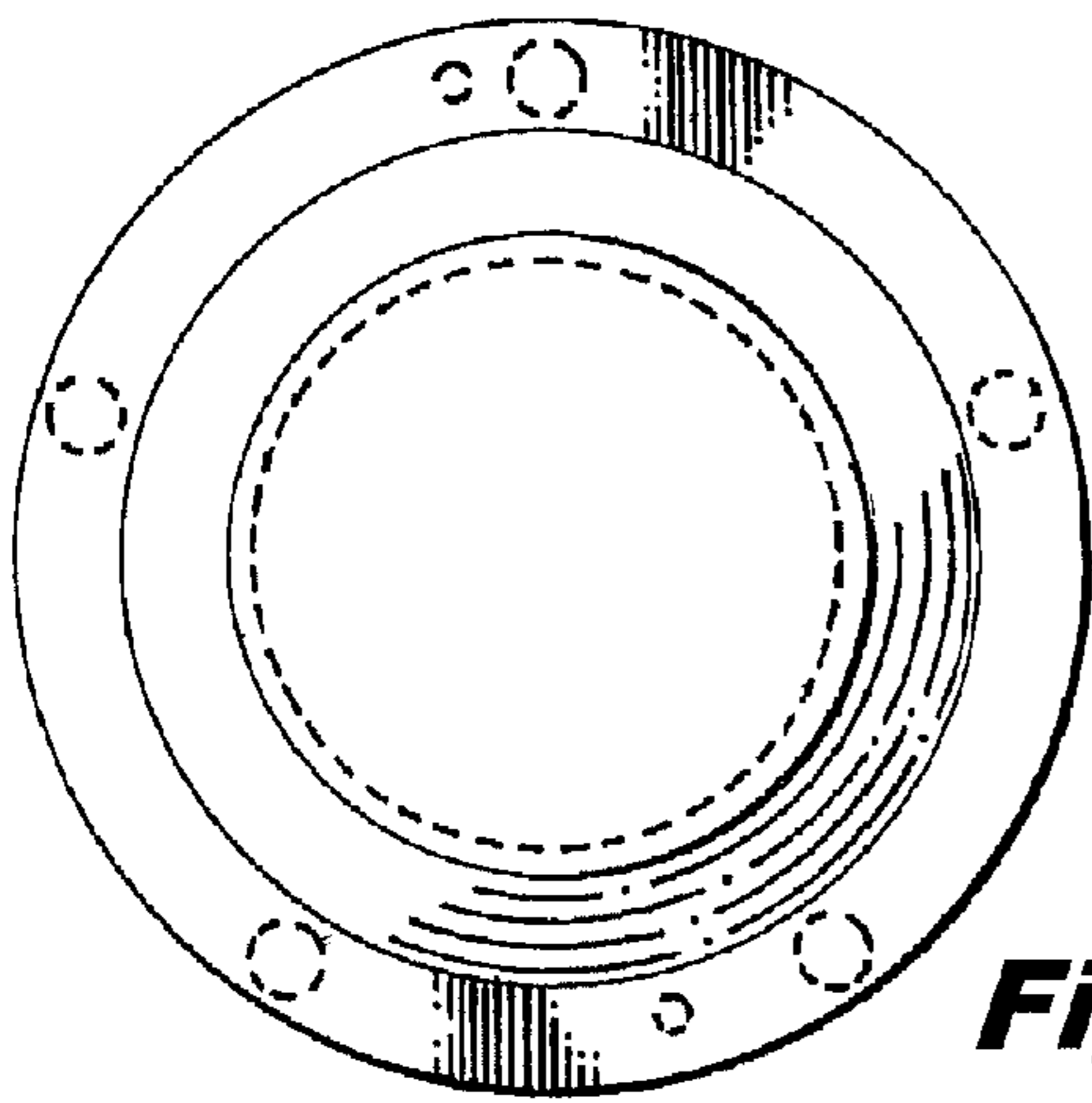




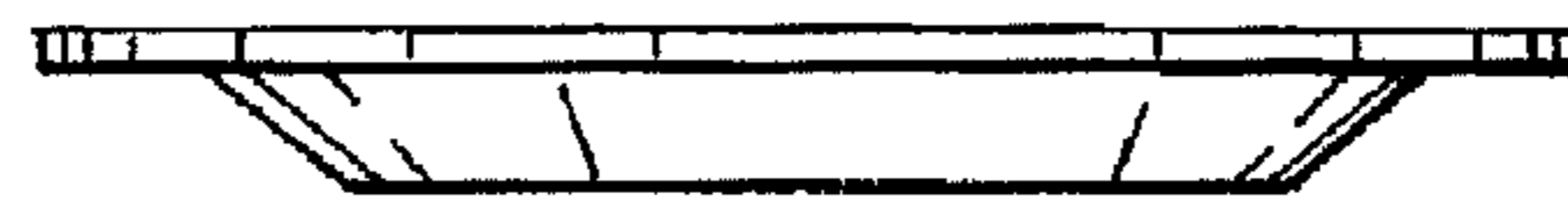
**Fig. 1**



**Fig. 2**



**Fig. 3**



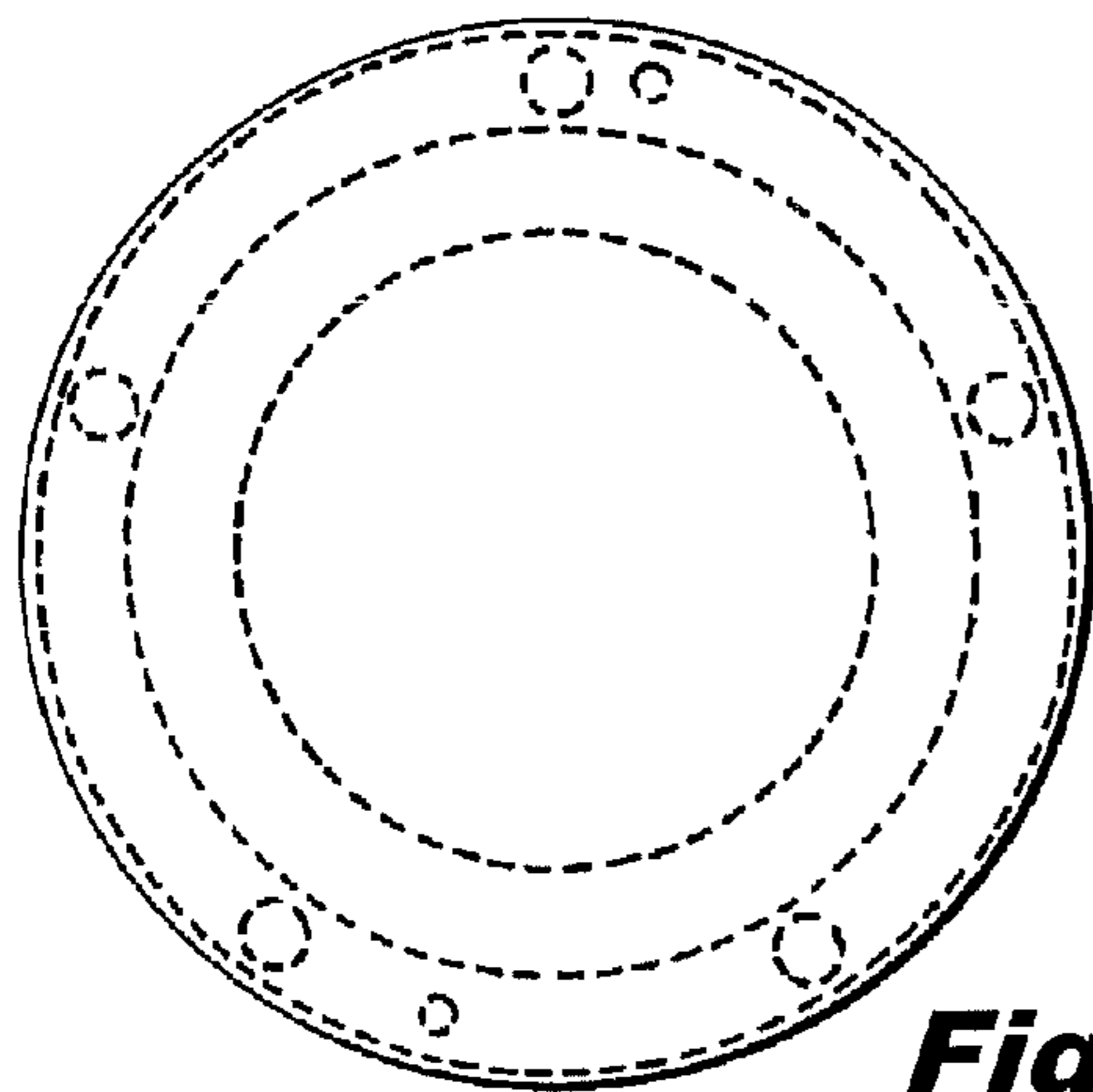
**Fig. 5**



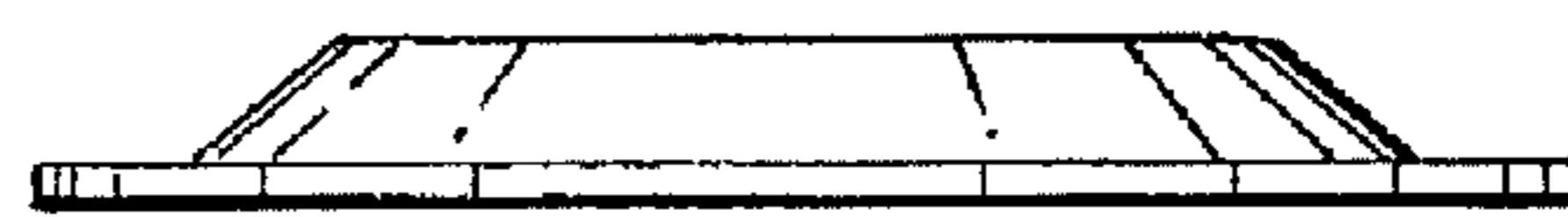
**Fig. 6**



**Fig. 7**



**Fig. 4**



**Fig. 8**