



US00D695113S

(12) **United States Design Patent**
Biery

(10) **Patent No.:** **US D695,113 S**

(45) **Date of Patent:** **** Dec. 10, 2013**

- (54) **CHEESE TRAY**
- (71) Applicant: **Biery Cheese Co.**, Louisville, OH (US)
- (72) Inventor: **Benjamin H. Biery**, Louisville, OH (US)
- (73) Assignee: **Biery Cheese Co.**, Louisville, OH (US)
- (**) Term: **14 Years**
- (21) Appl. No.: **29/451,584**
- (22) Filed: **Apr. 4, 2013**

D247,426 S *	3/1978	Montesi	D9/424
D249,233 S	9/1978	Florian		
4,252,268 A	2/1981	Haire		
4,381,847 A *	5/1983	Bessett et al.	229/406
4,442,969 A	4/1984	Holden		
D280,489 S	9/1985	Holden		
D294,466 S	3/1988	Culver		
D334,141 S	3/1993	Gottofredi		
D378,734 S	4/1997	Hardy et al.		
D428,540 S	7/2000	Grant		
D522,355 S	6/2006	Castellanos et al.		
D533,080 S	12/2006	Darin		
D553,817 S	10/2007	Moon		
D591,173 S	4/2009	Church		
D597,831 S	8/2009	Clark et al.		
D602,352 S	10/2009	Pendergrass et al.		
D603,255 S	11/2009	King		
7,921,992 B2	4/2011	LaRue et al.		
D682,682 S *	5/2013	Biery	D9/432

Related U.S. Application Data

- (62) Division of application No. 29/428,775, filed on Aug. 3, 2012, now Pat. No. Des. 682,682.
- (51) **LOC (9) Cl.** **09-03**
- (52) **U.S. Cl.**
USPC **D9/432**
- (58) **Field of Classification Search**
USPC D9/414-416, 418, 420-424, 430-433,
D9/434, 455-456, 761; D7/601-602;
229/100, 101, 102.5, 103, 106-112,
229/114, 120, 121, 124, 161, 162.1, 163,
229/164.2, 182.1, 406-407; 206/38
See application file for complete search history.

* cited by examiner

Primary Examiner — Susan Bennett Hattan

Assistant Examiner — Vy Koenig

(74) *Attorney, Agent, or Firm* — Sand & Sebolt

(57) **CLAIM**

The ornamental design for a cheese tray, as shown and described.

DESCRIPTION

FIG. 1 is a perspective view of the cheese tray of the present invention;

FIG. 2 is a top view thereof;

FIG. 3 is a bottom view thereof;

FIG. 4 is a front side elevational view thereof;

FIG. 5 is a rear side elevational view thereof;

FIG. 6 is a right side elevational view thereof; and,

FIG. 7 is a left side elevational view thereof.

1 Claim, 5 Drawing Sheets

(56) **References Cited**

U.S. PATENT DOCUMENTS

3,405,858 A *	10/1968	Collie	229/407
3,583,623 A *	6/1971	Golner et al.	229/406
3,682,365 A *	8/1972	Reifers et al.	229/407
D227,084 S	6/1973	Karlsen		
D244,352 S	5/1977	Congleton		
4,058,247 A *	11/1977	Florian	229/407

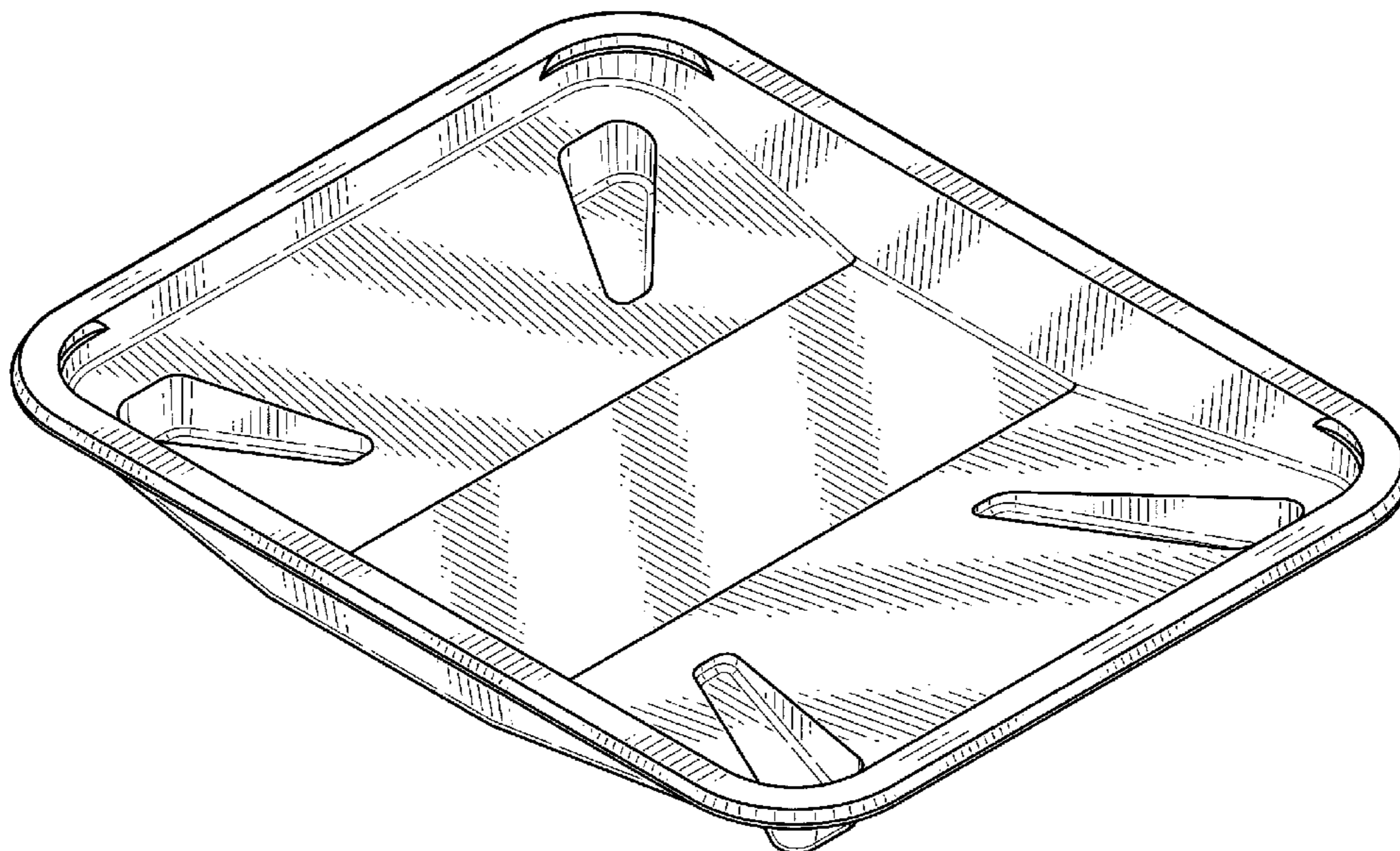

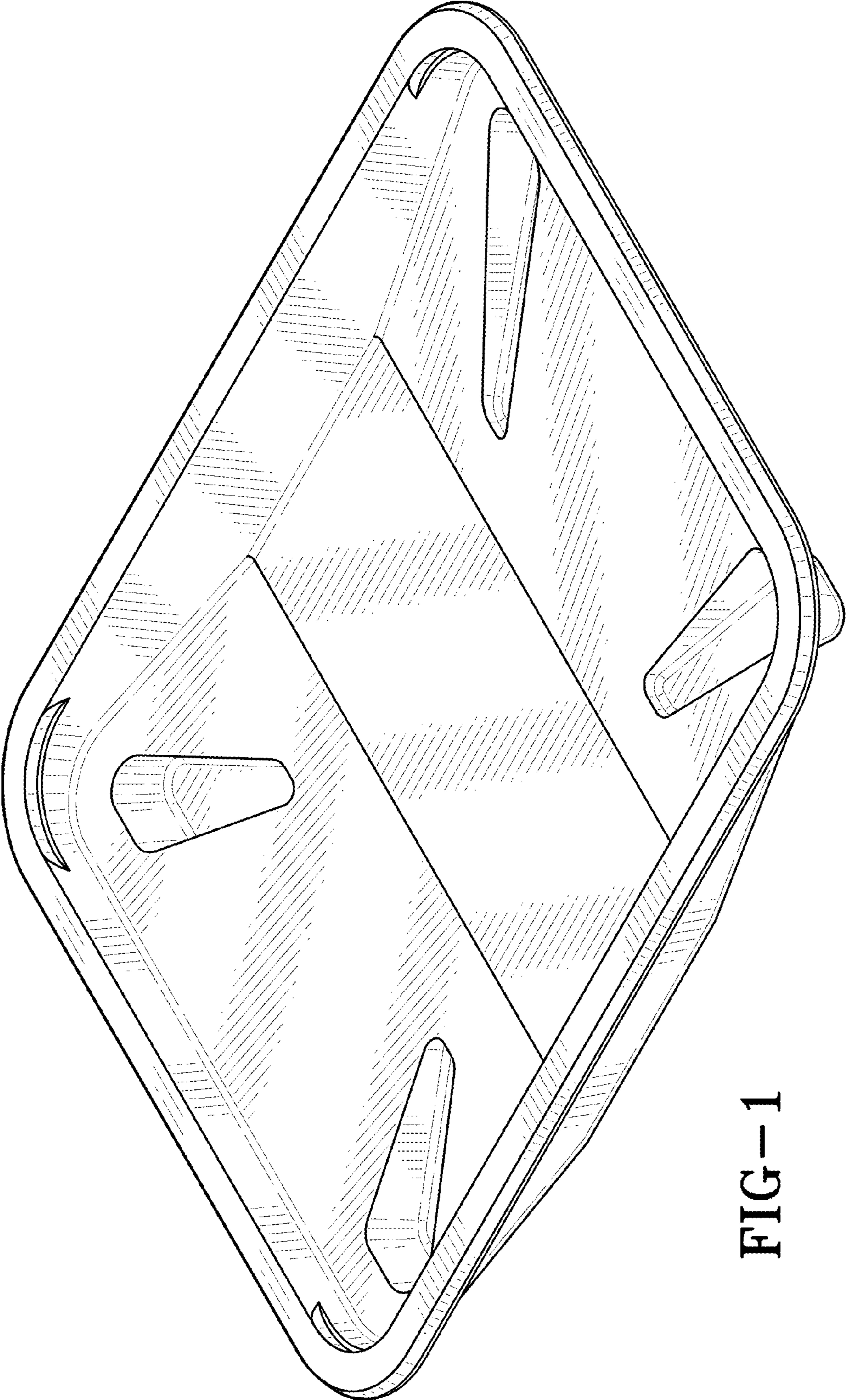

FIG-1

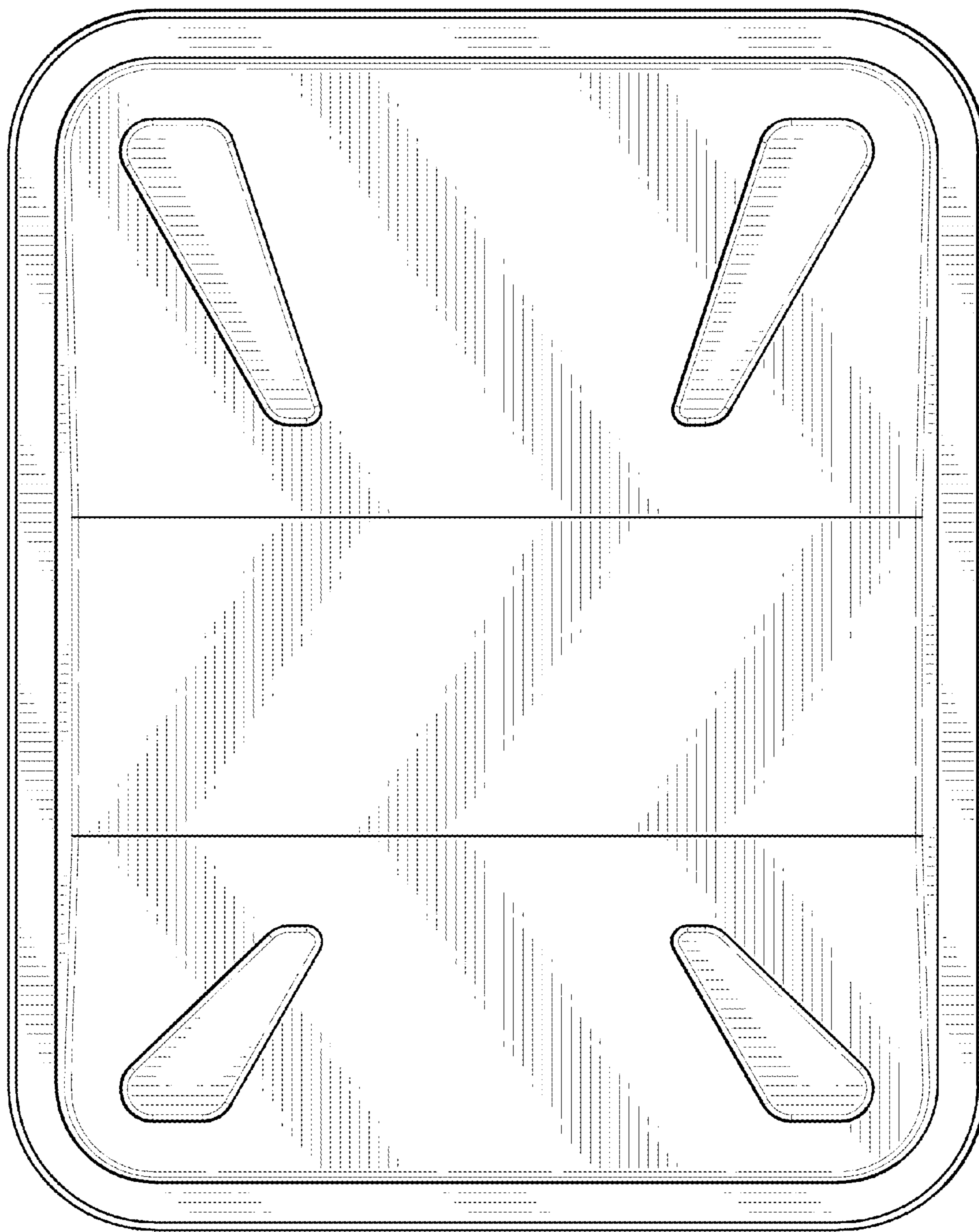

FIG-2

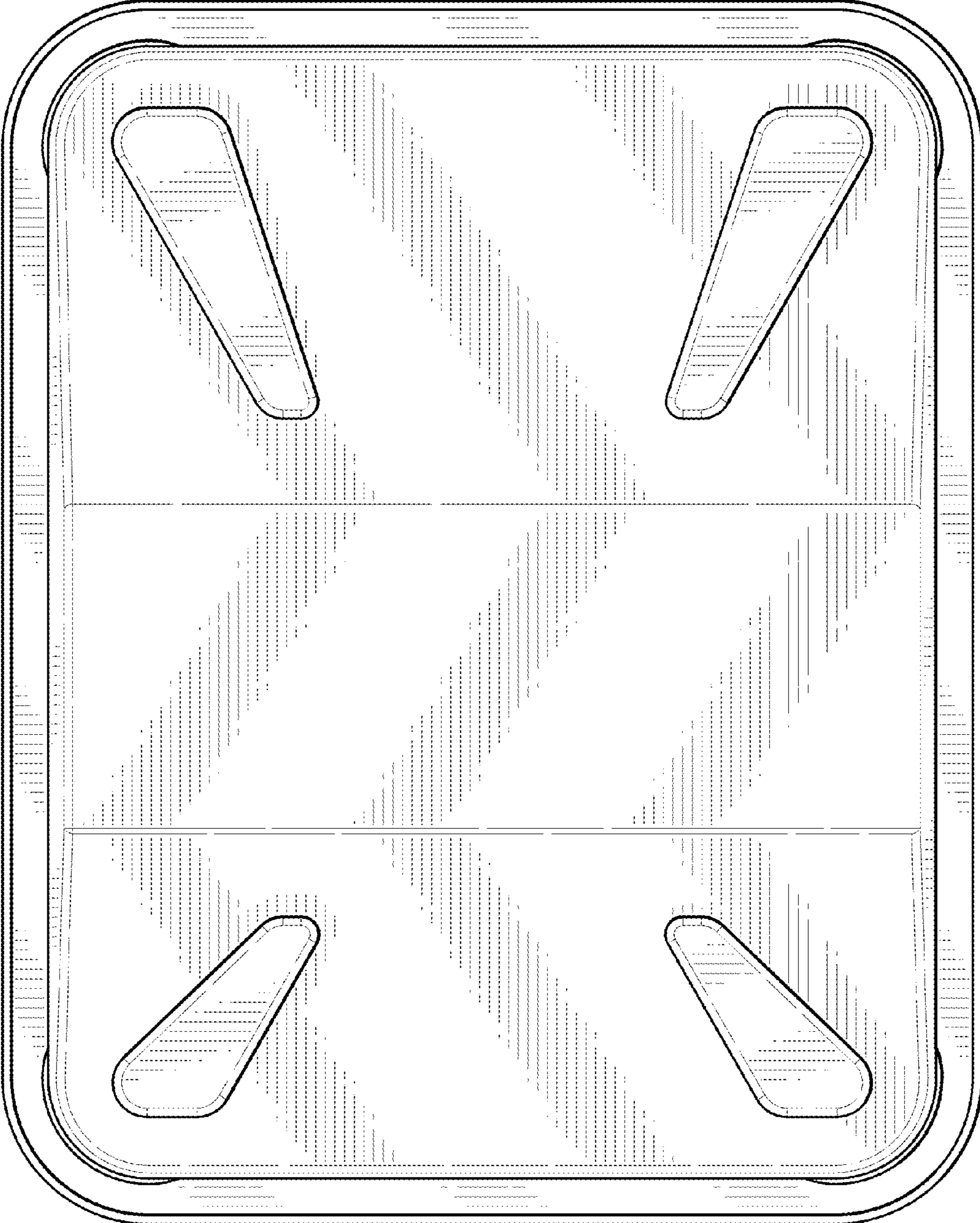

FIG-3

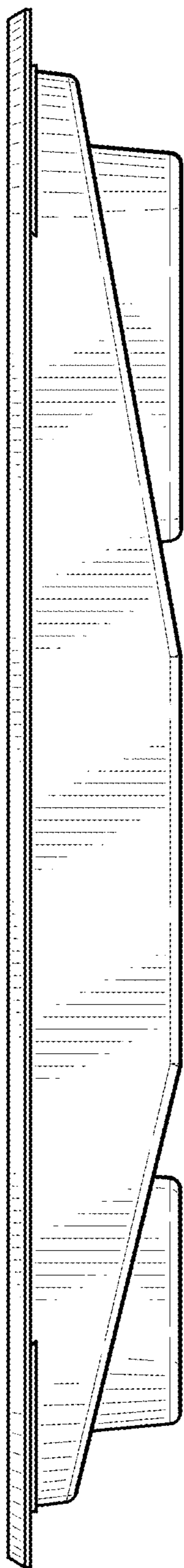

FIG-4

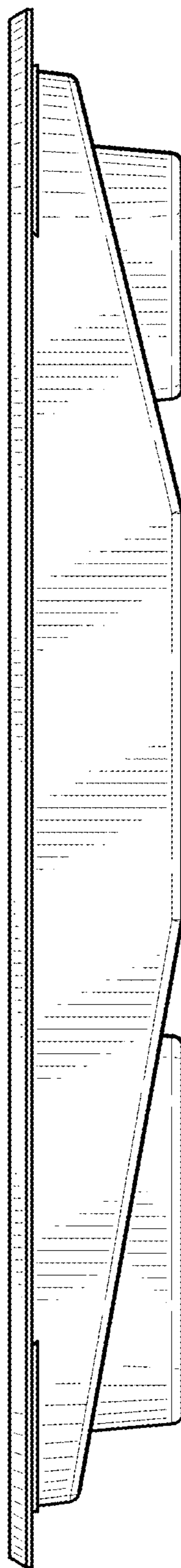

FIG-5

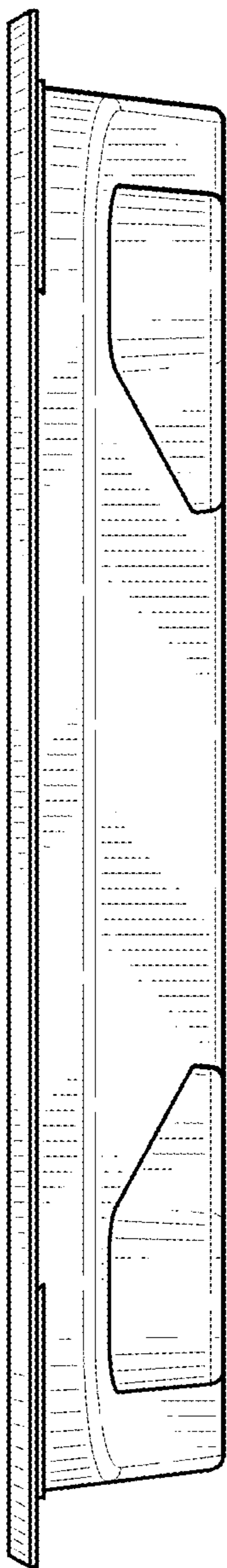

FIG-6

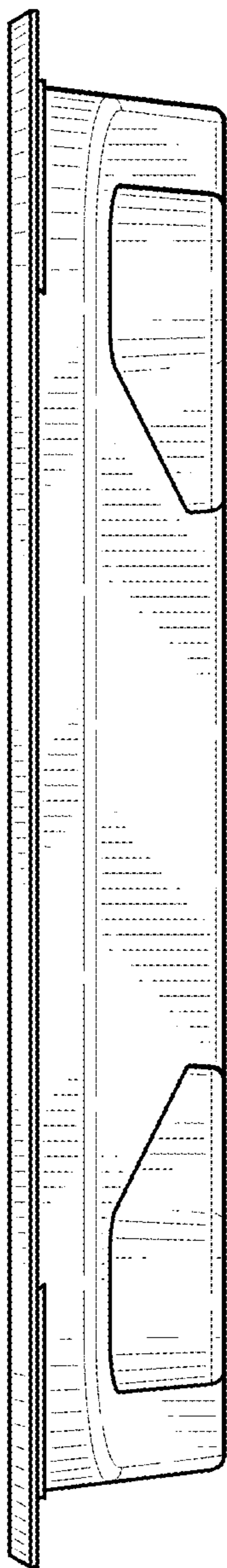

FIG-7