



US00D695108S

(12) **United States Design Patent**
Pham et al.

(10) **Patent No.:** **US D695,108 S**

(45) **Date of Patent:** **** Dec. 10, 2013**

(54) **CONTAINER**

(75) Inventors: **Steven Pham**, Naugatuck, CT (US);
Bruce Stein, Easton, CT (US)

(73) Assignee: **Inline Plastics Corp.**, Shelton, CT (US)

(**) Term: **14 Years**

(21) Appl. No.: **29/428,218**

(22) Filed: **Jul. 27, 2012**
(Under 37 CFR 1.47)

(51) **LOC (9) Cl.** **09-03**

(52) **U.S. Cl.**
USPC **D9/426**

(58) **Field of Classification Search**
USPC D9/414, 419, 424, 425, 436, 430, 431,
D9/432, 435, 737, 761; D7/538, 549,
D7/550.1, 601-603, 605, 629; 229/105,
229/117.09, 117.26, 189, 406, 407, 902,
229/905, 915.1; 220/23.4, 23.6, 266, 281,
220/315, 318, 500, 659, 669, 674, 675, 696,
220/752, 760, 790, 793, DIG. 12, FOR. 117;
206/508; D3/276

See application file for complete search history.

(56) **References Cited**

U.S. PATENT DOCUMENTS

D376,314 S * 12/1996 Krupa D9/425
D407,014 S * 3/1999 McCann D9/423
D408,734 S * 4/1999 McCann D9/423

D468,637 S * 1/2003 Chou D9/425
D512,305 S * 12/2005 Ramirez et al. D9/425
D620,790 S * 8/2010 Lovett D9/425
D628,474 S * 12/2010 Snedden et al. D9/426
D640,544 S * 6/2011 Sifuentes et al. D9/425
D663,633 S * 7/2012 Rivera et al. D9/737
D664,428 S * 7/2012 Rivera et al. D9/426
D688,551 S * 8/2013 Wahl D9/426

* cited by examiner

Primary Examiner — Thomas Johannes

(74) *Attorney, Agent, or Firm* — Edwards Wildman Palmer
LLP

(57) **CLAIM**

The ornamental design for a container, as is shown and described.

DESCRIPTION

FIG. 1 is a top perspective view of a container showing our new design;
FIG. 2 is a front view thereof;
FIG. 3 is a right side view thereof;
FIG. 4 is a back view thereof;
FIG. 5 is a left side view thereof;
FIG. 6 is a top view thereof;
FIG. 7 is a bottom view thereof; and,
FIG. 8 is a bottom perspective view thereof.
The broken lines shown in the drawings represent unclaimed portions of the container and form no part of the claimed design.

1 Claim, 6 Drawing Sheets

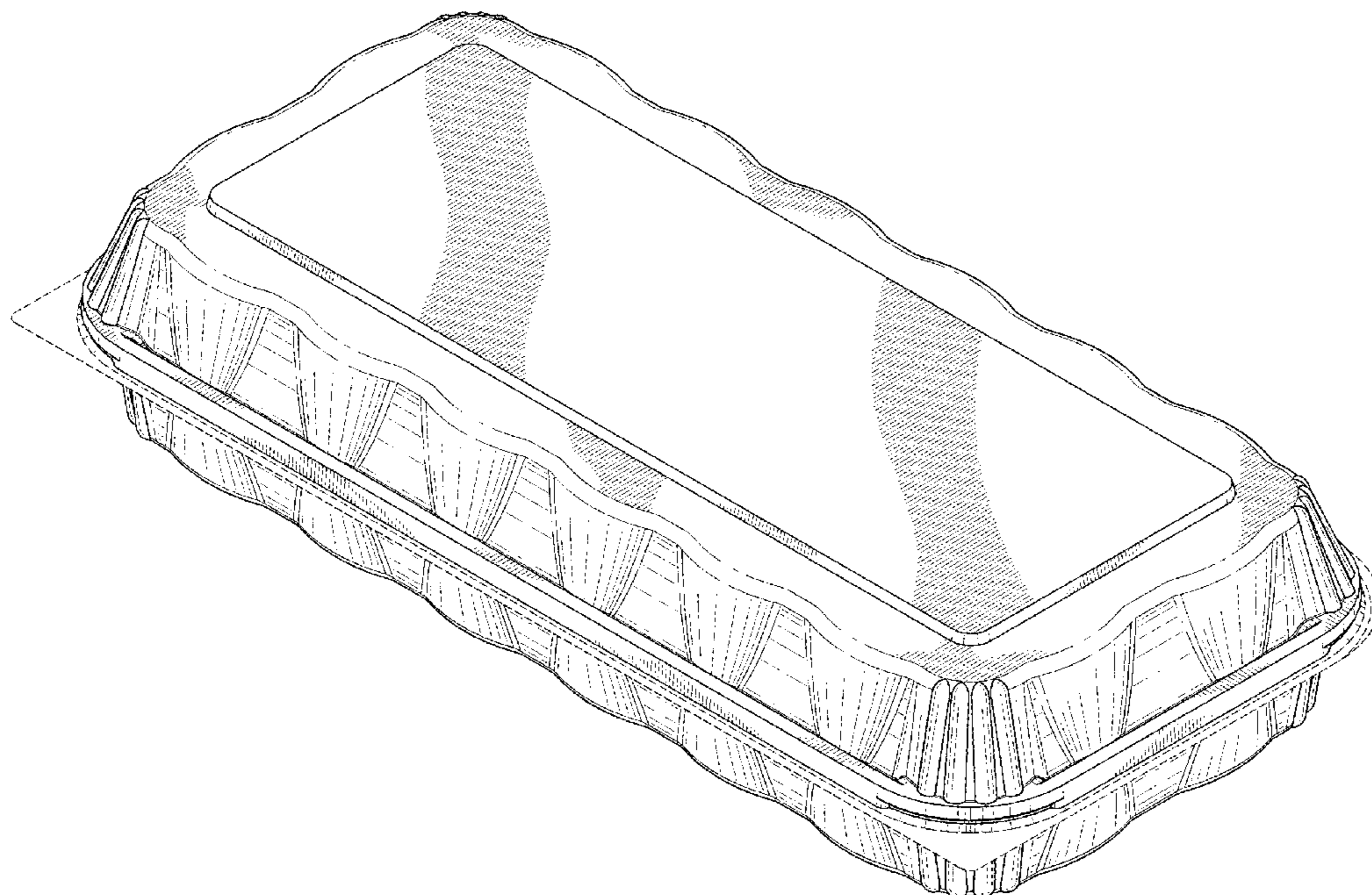

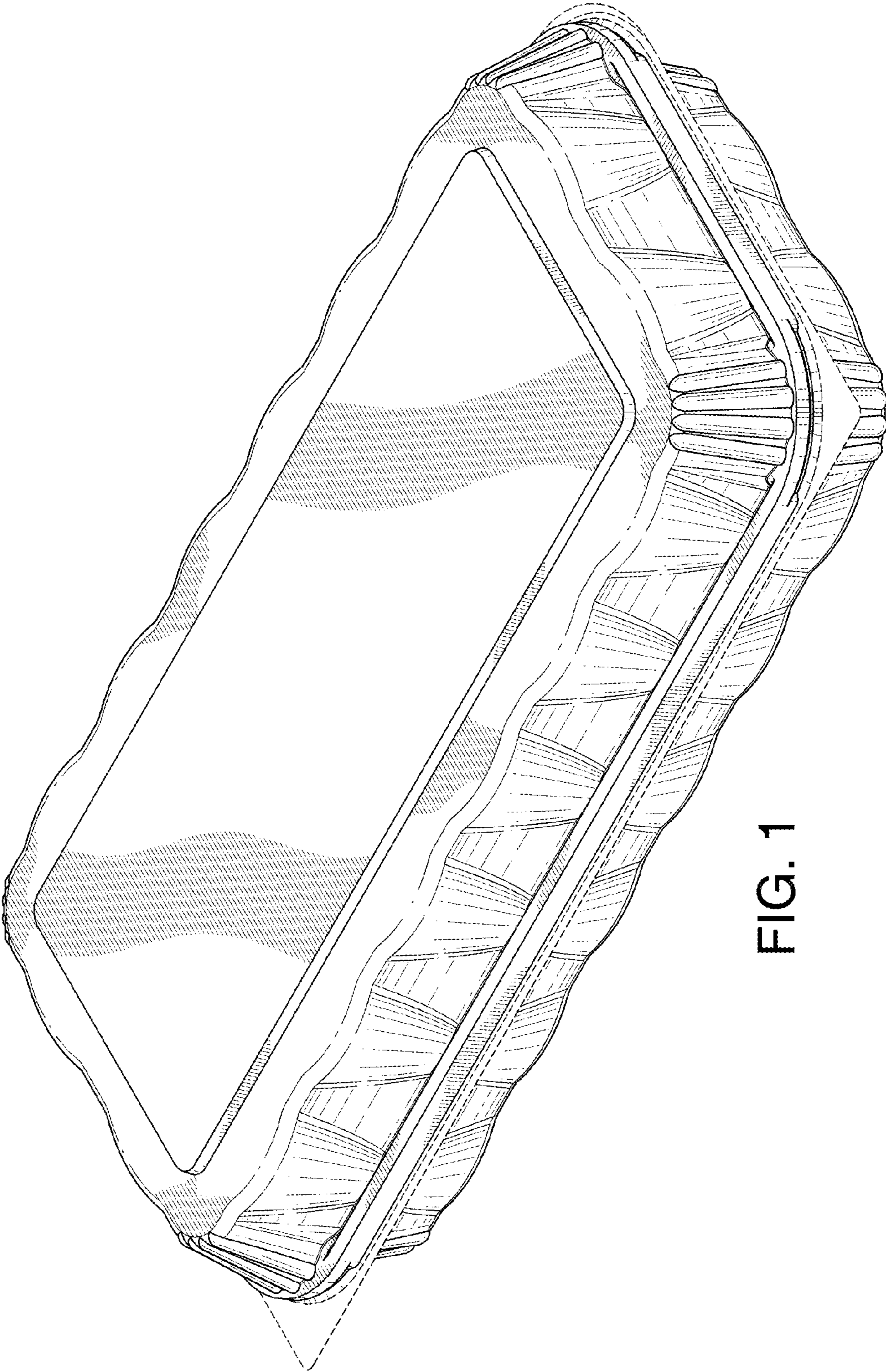

FIG. 1

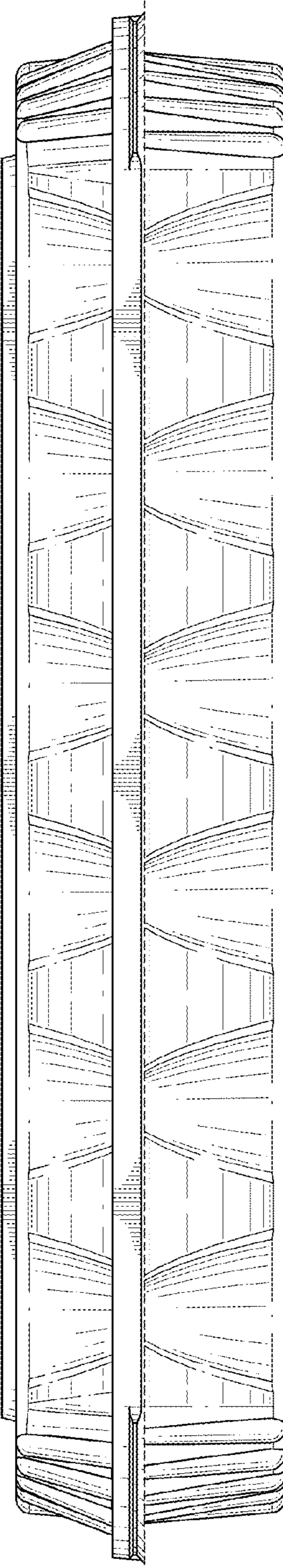

FIG. 2

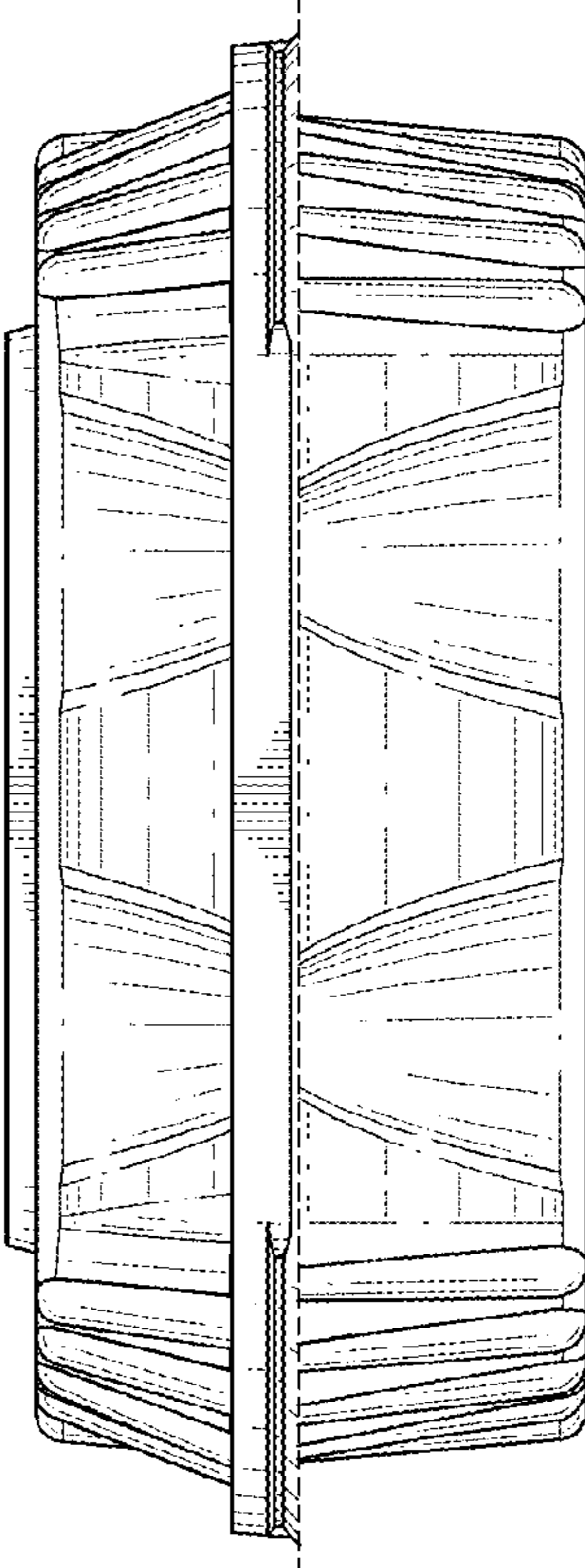

FIG. 3

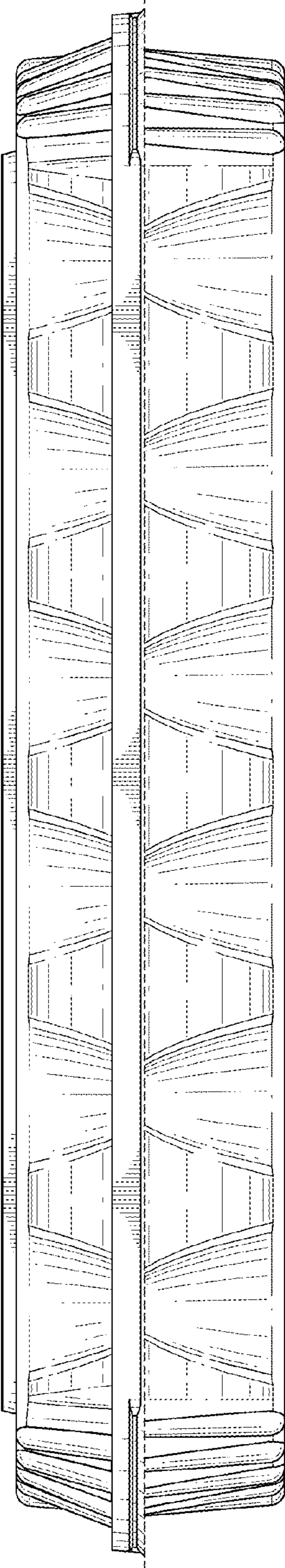

FIG. 4

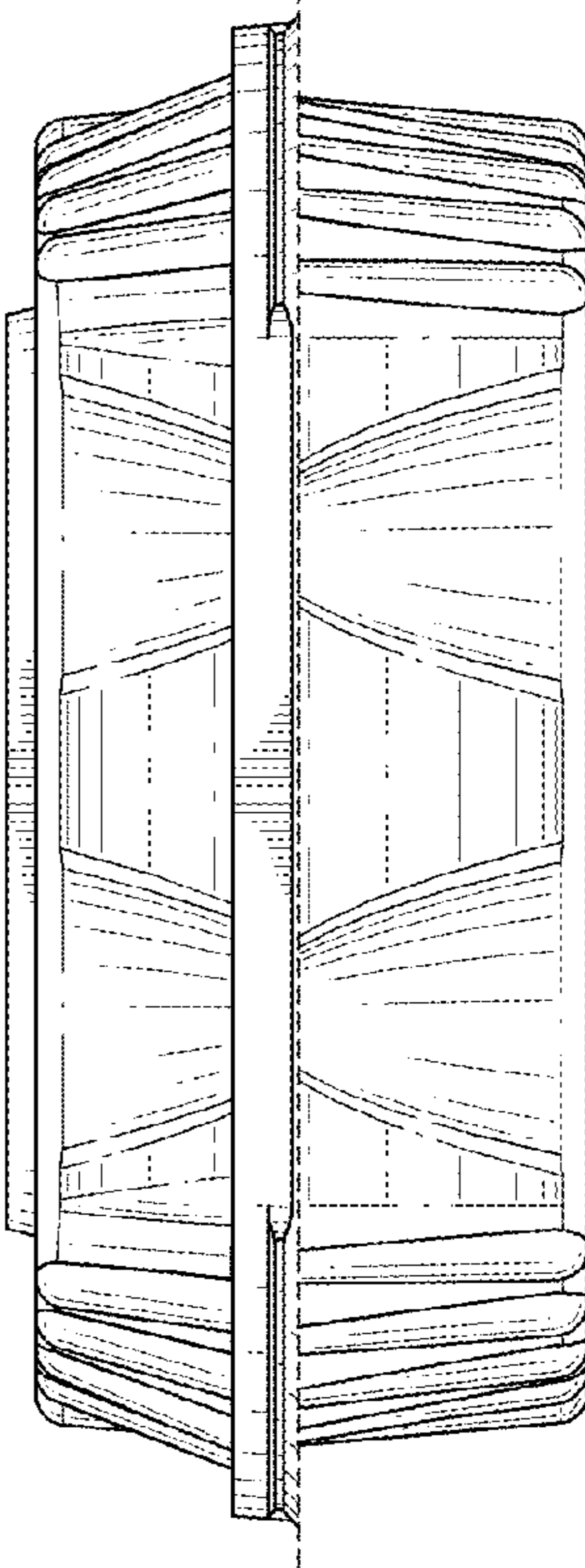

FIG. 5

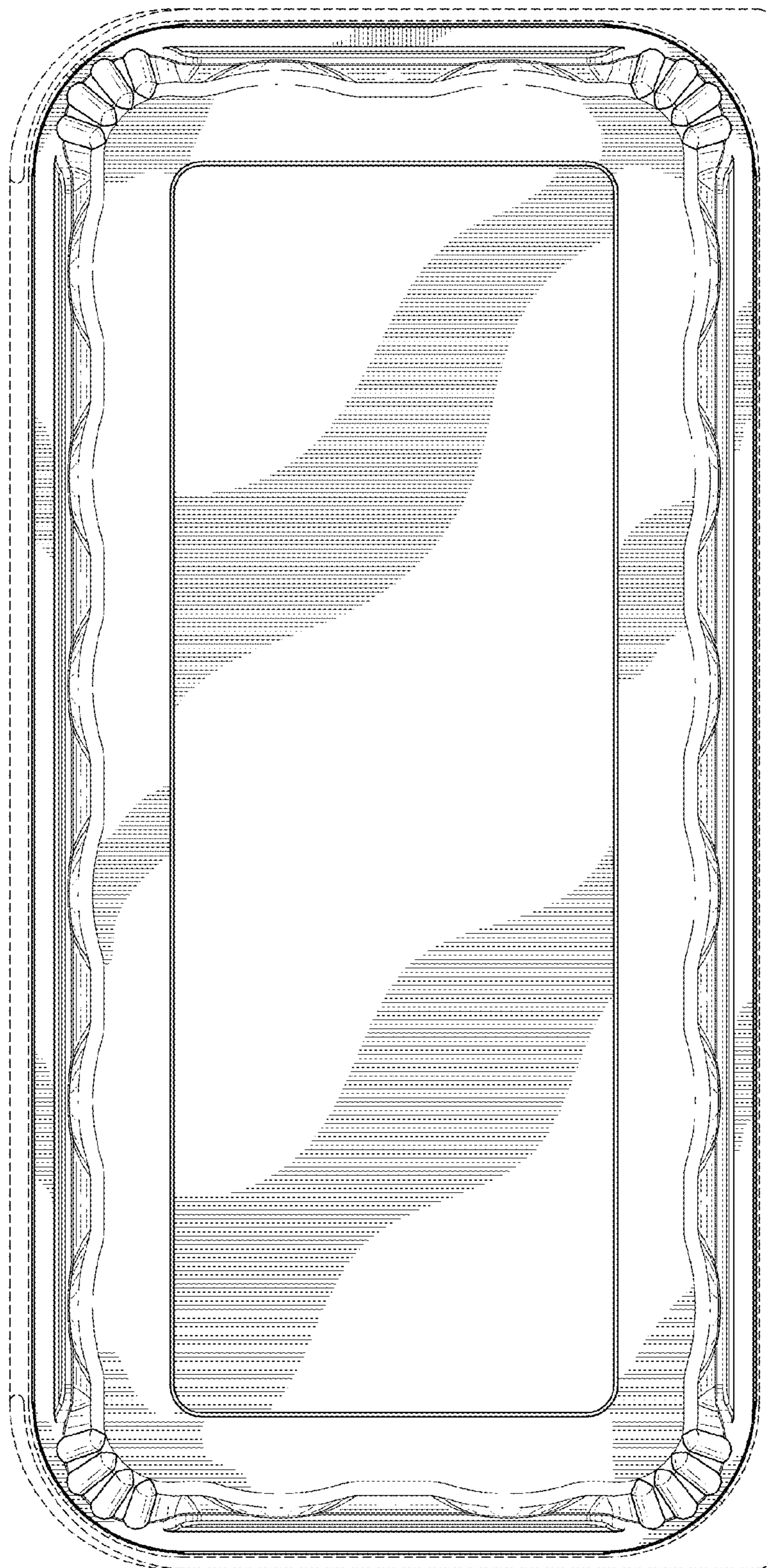

FIG. 6

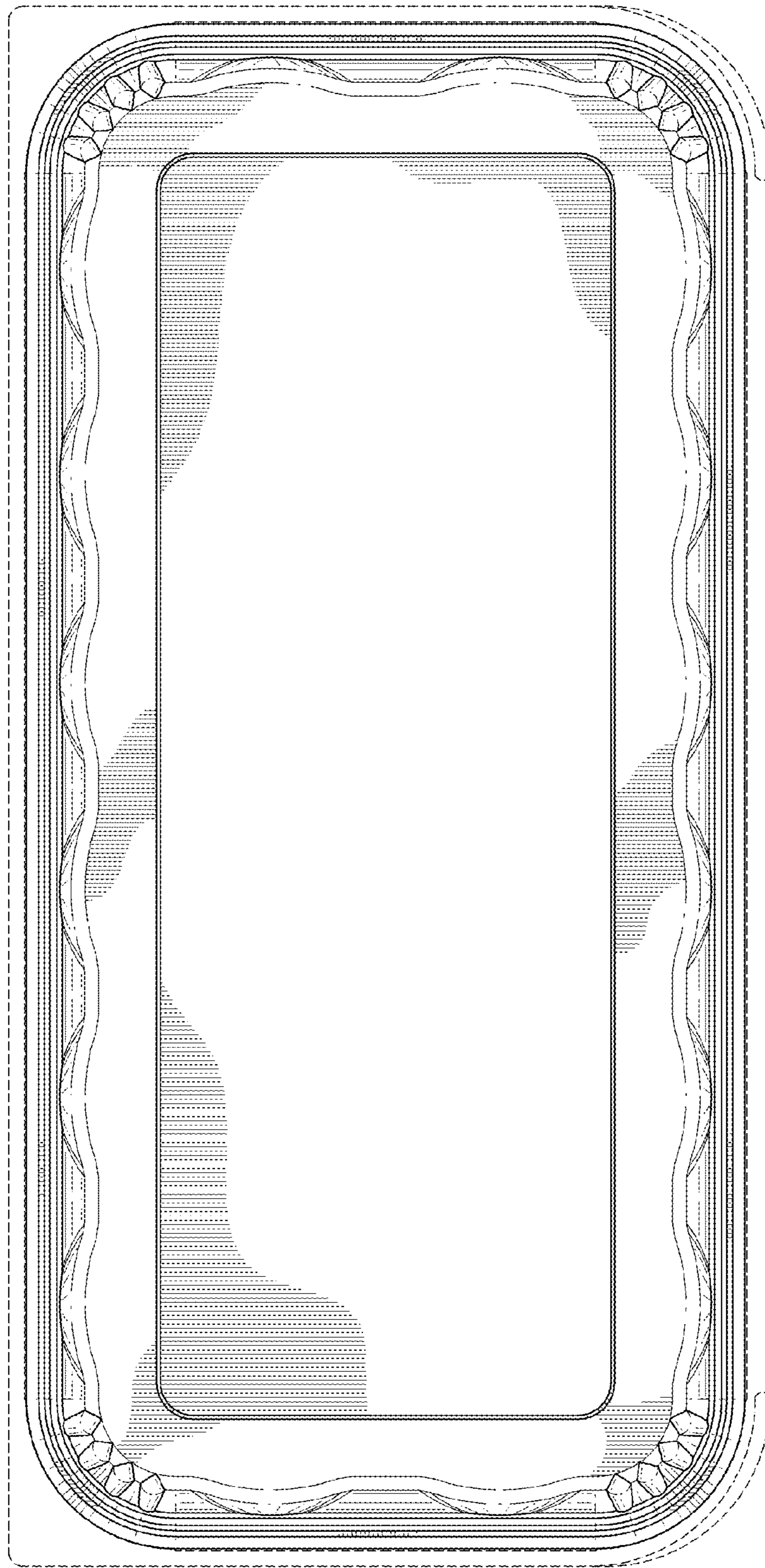

FIG. 7

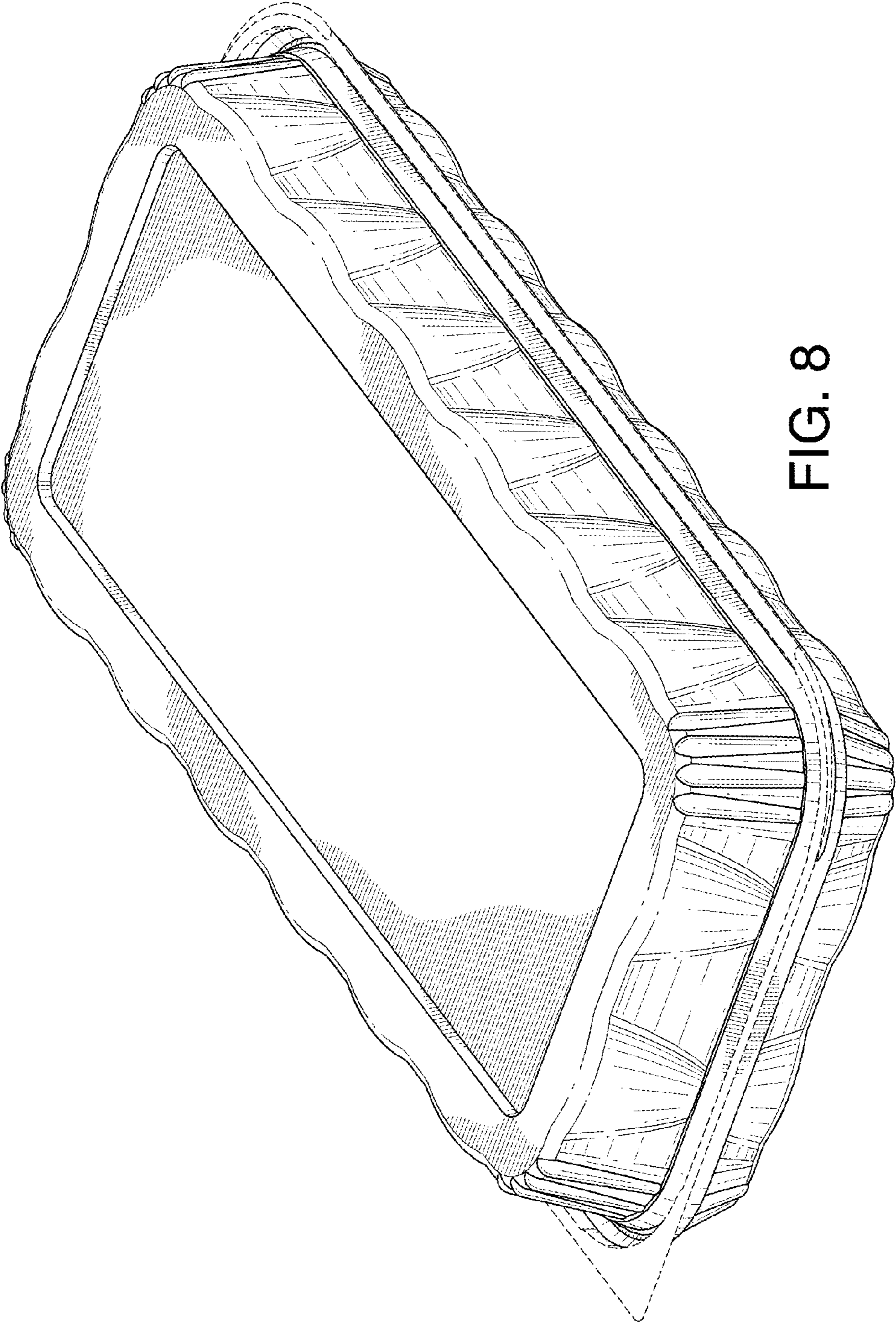

FIG. 8