



US00D695107S

(12) **United States Design Patent**  
**Clements**

(10) **Patent No.:** **US D695,107 S**

(45) **Date of Patent:** **\*\* Dec. 10, 2013**

- (54) **THREE COMPARTMENT TRAY**
- (71) Applicant: **Curwood, Inc.**, Oshkosh, WI (US)
- (72) Inventor: **James W. Clements**, Russellville, AR (US)
- (73) Assignee: **Curwood, Inc.**, Oshkosh, WI (US)
- (\*\*) Term: **14 Years**
- (21) Appl. No.: **29/459,253**
- (22) Filed: **Jun. 27, 2013**
- (51) **LOC (9) Cl.** ..... **09-03**
- (52) **U.S. Cl.**  
USPC ..... **D9/425; D9/761**
- (58) **Field of Classification Search**  
USPC ..... D9/424, 425, 430, 431, 434, 435, 737,  
D9/761; D7/354, 357, 396.1, 550.1, 555,  
D7/629, 701; 229/400-406, 932, 906.1;  
220/23.2-23.8, 513, 516, 519, 556,  
220/575; 206/499, 508, 549, 557  
See application file for complete search history.

- D508,634 S 8/2005 Chambers et al.
- D512,836 S 12/2005 Marnell, II
- 7,114,630 B2 10/2006 Dege et al.
- D537,633 S 3/2007 Marnell, II
- D538,102 S 3/2007 Dege et al.
- D540,453 S 4/2007 Wang
- D555,475 S 11/2007 Enriquez et al.
- D555,938 S 11/2007 Brisco
- D557,987 S 12/2007 Hoehne
- 7,370,455 B2 5/2008 Dewey et al.
- D573,409 S \* 7/2008 Lovett ..... D7/553.3
- D596,445 S 7/2009 Nolan
- D596,446 S 7/2009 Nolan
- D596,448 S 7/2009 Nolan
- D596,449 S 7/2009 Nolan
- D614,449 S 4/2010 Cooper
- D615,320 S 5/2010 Griffin et al.
- D616,250 S 5/2010 Peyton et al.
- D625,960 S 10/2010 Lipfert et al.
- D629,681 S \* 12/2010 Ehrmann ..... D9/425
- D631,696 S 2/2011 Lipfert et al.

**OTHER PUBLICATIONS**

USPTO Trademark Registration No. 4021091, registration date Sep. 6, 2011.

\* cited by examiner

*Primary Examiner* — Thomas Johannes

(56) **References Cited**

**U.S. PATENT DOCUMENTS**

- 2,738,915 A \* 3/1956 St Clair Truman ..... 229/406
- D235,499 S \* 6/1975 Day ..... D7/553.3
- 5,690,245 A \* 11/1997 Jenkins ..... 220/23.4
- D436,730 S 1/2001 Dembicks
- D437,116 S 2/2001 Dembicks
- D447,871 S 9/2001 Dembicks
- D450,185 S 11/2001 Dembicks
- D450,186 S 11/2001 Dembicks
- D450,454 S 11/2001 Dembicks
- D450,455 S 11/2001 Dembicks
- D451,676 S 12/2001 Dembicks
- D452,077 S 12/2001 Dembicks
- D452,078 S 12/2001 Dembicks
- D452,376 S 12/2001 Dembicks
- D474,600 S 5/2003 Lewis
- D492,195 S 6/2004 Shabaz

(57) **CLAIM**

The ornamental design for a three compartment tray, as shown and described.

**DESCRIPTION**

FIG. 1 is an isometric view of a three compartment tray showing my new design;  
FIG. 2 is a top view thereof;  
FIG. 3 is a front elevation view thereof;  
FIG. 4 is a rear elevation view thereof;  
FIG. 5 is a right elevation view thereof; and,  
FIG. 6 is a left elevation view thereof.

**1 Claim, 6 Drawing Sheets**

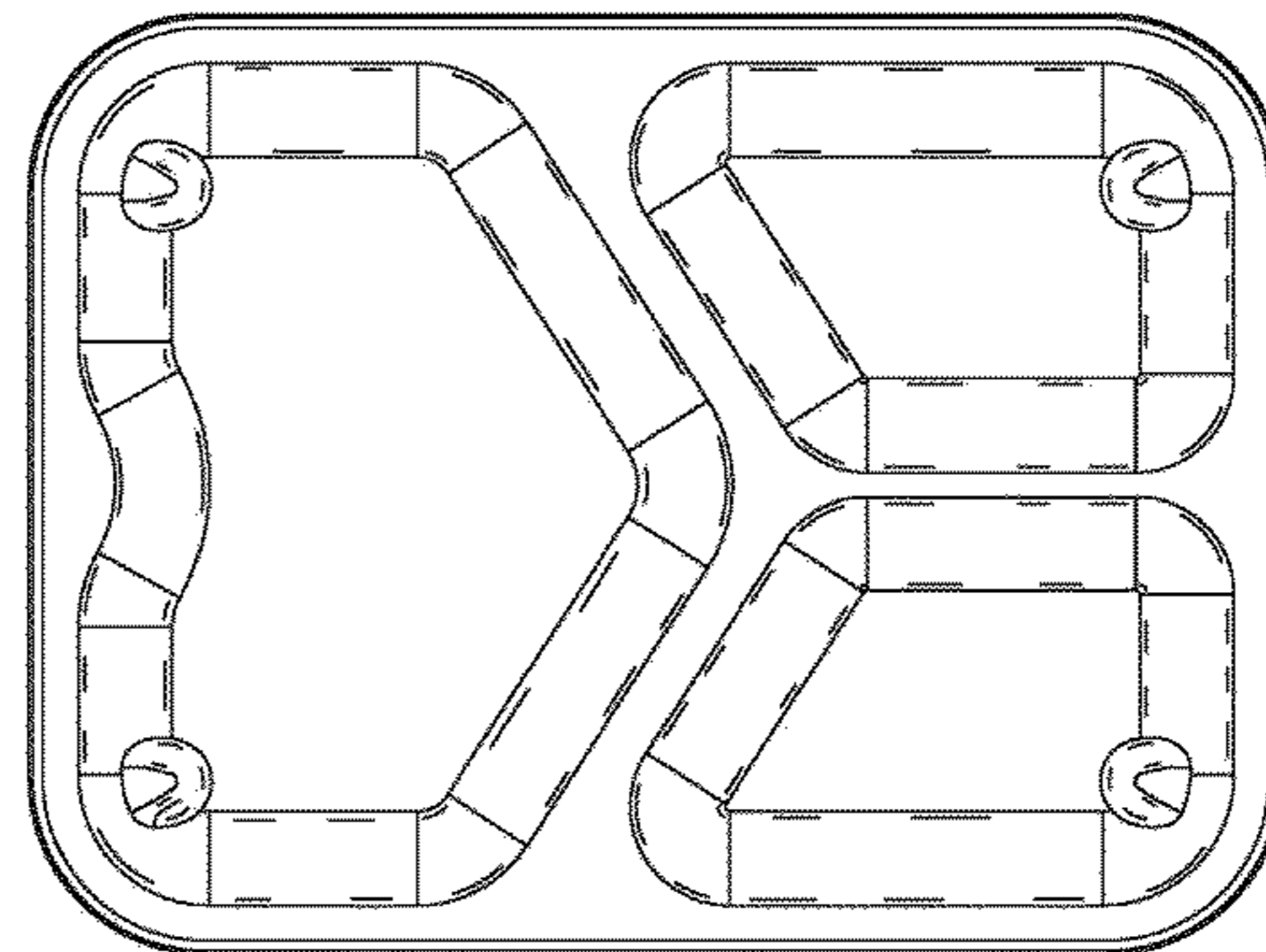
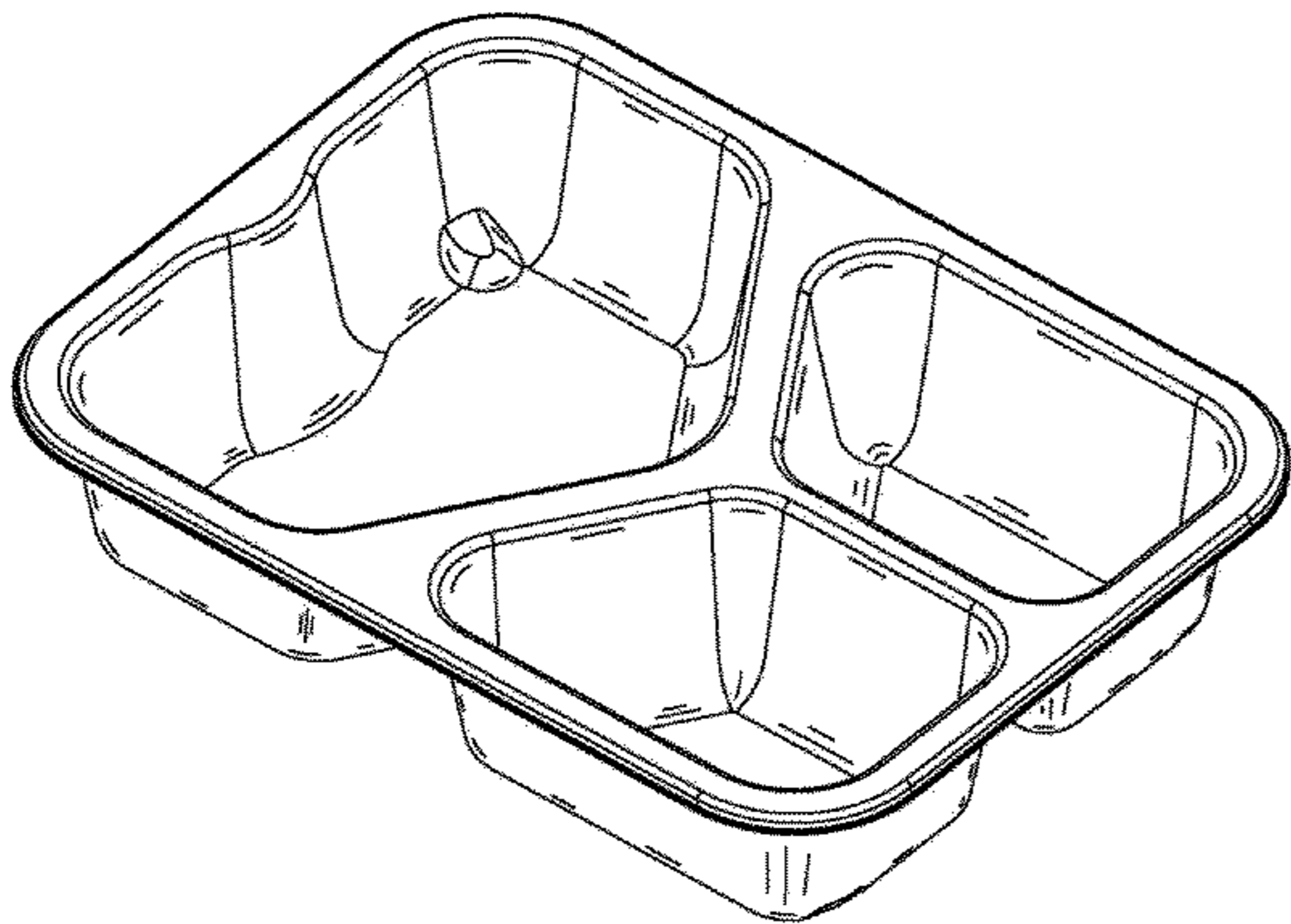

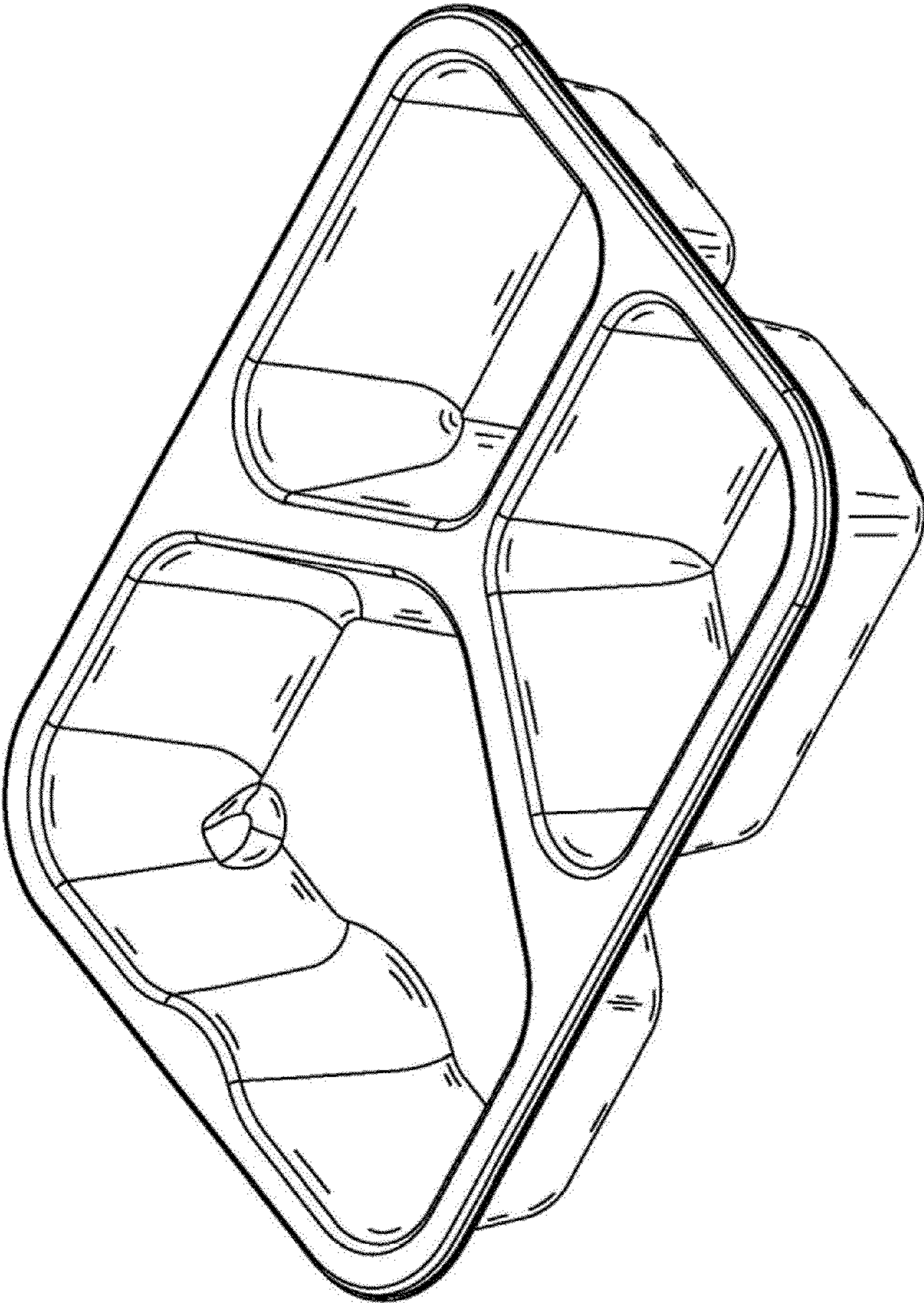

Fig. 1

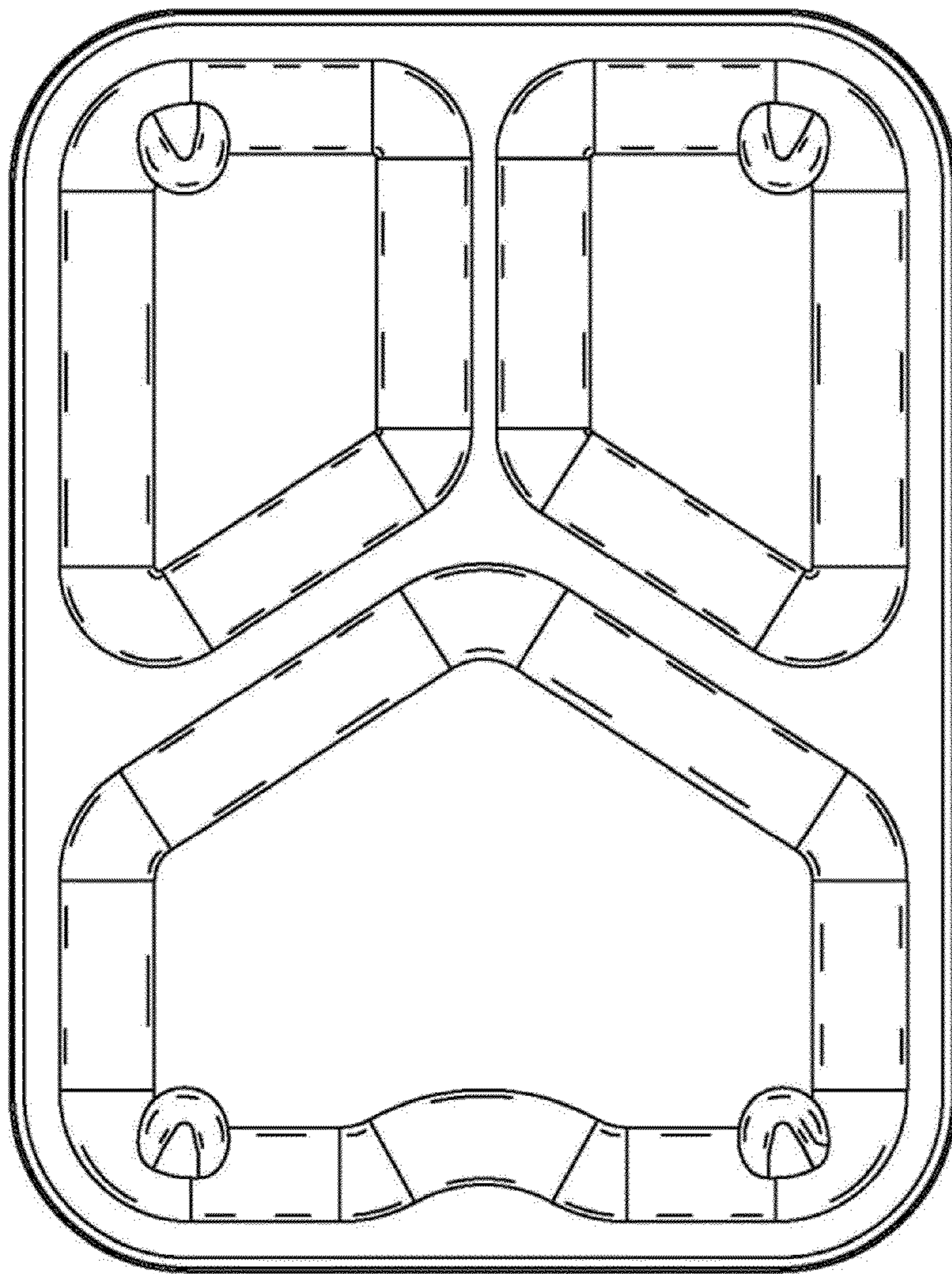

Fig. 2

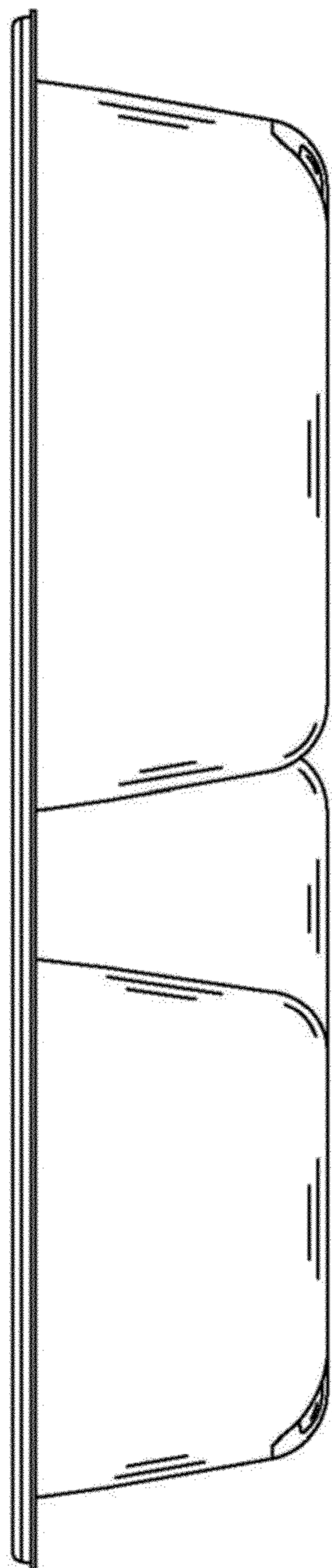

Fig. 3

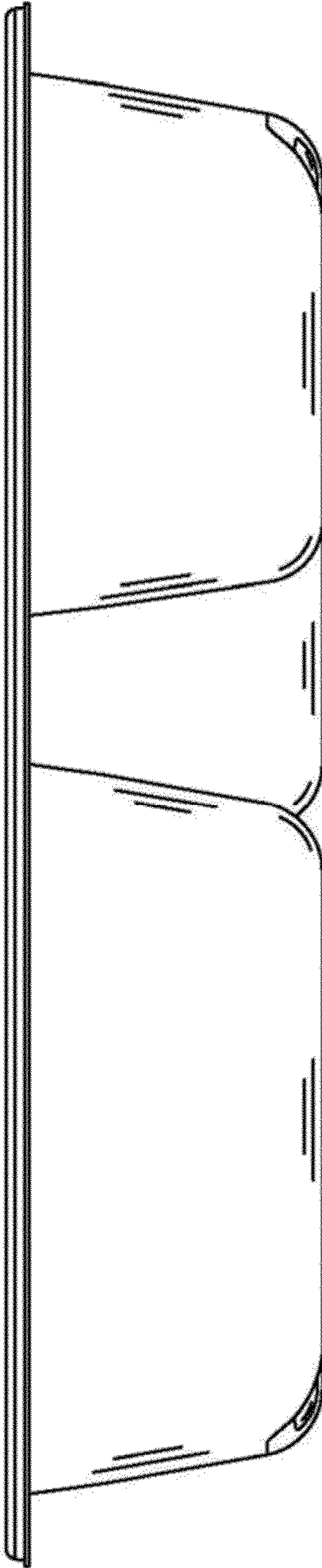

Fig. 4

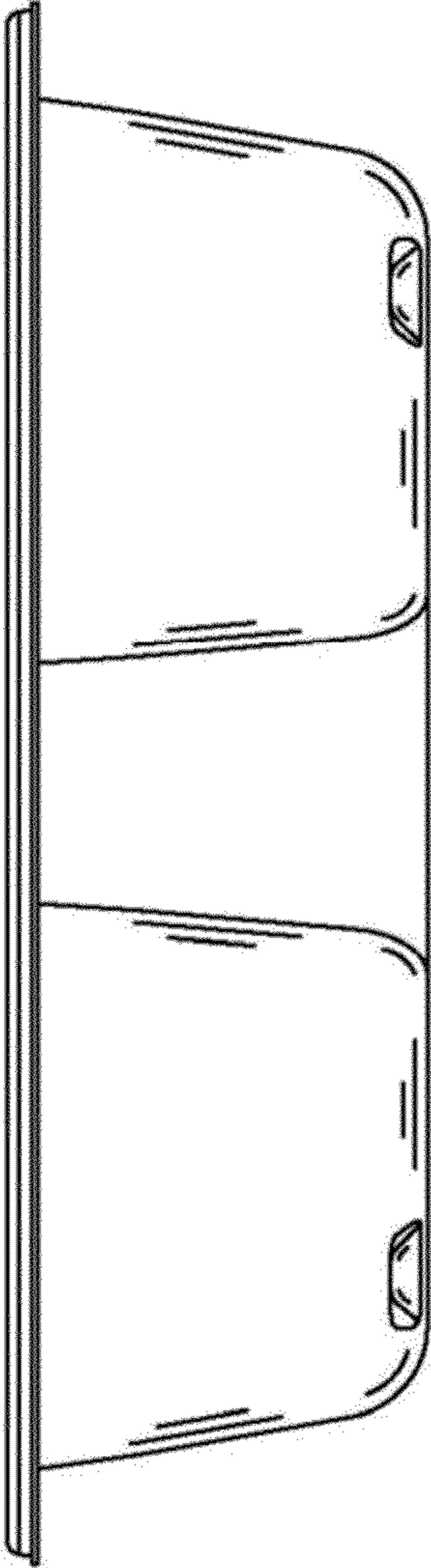

Fig. 5

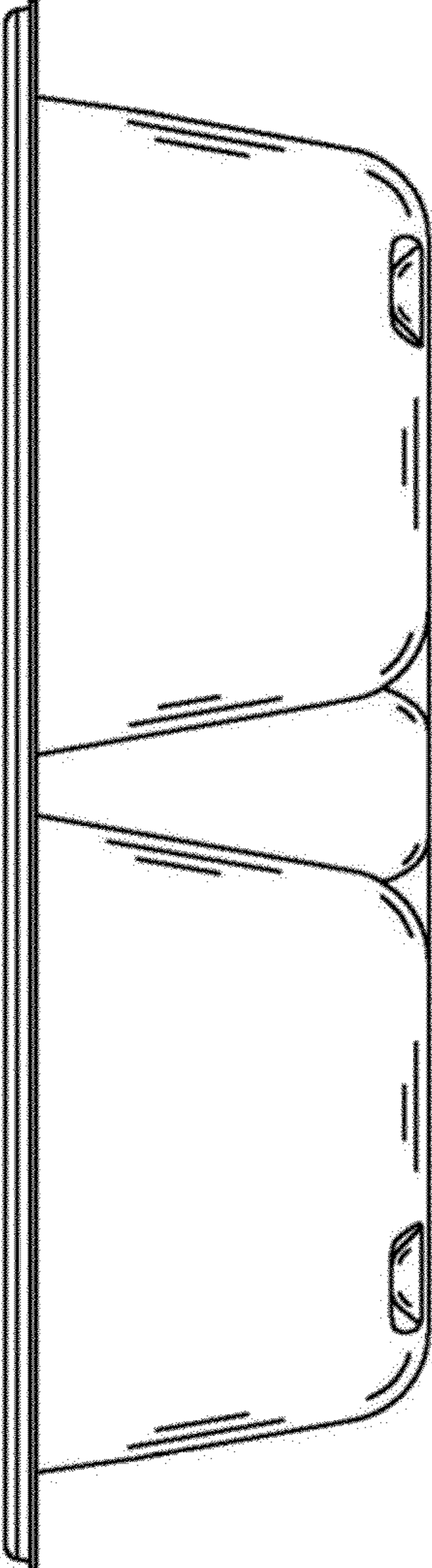

Fig. 6