

US00D695102S

(12) **United States Design Patent**
Keberlein et al.

(10) **Patent No.:** **US D695,102 S**

(45) **Date of Patent:** **** Dec. 10, 2013**

(54) **CONTAINER**

(75) Inventors: **Gerald J. Keberlein**, Hortonville, WI (US); **Gregory A. DiLoreto**, Neenah, WI (US)

(73) Assignee: **Trinova Design, LLC**, Appleton, WI (US)

(**) Term: **14 Years**

(21) Appl. No.: **29/401,924**

(22) Filed: **Sep. 16, 2011**

(51) **LOC (9) Cl.** **09-03**

(52) **U.S. Cl.**
USPC **D9/416**

(58) **Field of Classification Search**
USPC D9/414, 415, 418, 416, 420, 423, 428, D9/430-433, 435, 445, 449, 455, 456, 465, D9/499, 501-503, 522, 529, 645, 651, D9/688-692, 737-738, 740-742, 744, 751, D9/755, 711, 756, 760, 727, 758, 749; D24/216; 220/23.87-23.89, 560.01, 220/560.1, 579; 206/467

See application file for complete search history.

(56) **References Cited**

U.S. PATENT DOCUMENTS

D187,756 S * 4/1960 Storz D9/420
3,343,743 A 9/1967 Hamilton et al.

(Continued)

OTHER PUBLICATIONS

http://vintagestory.ru/UserFiles/File/articles/design_and_decor/text42/110.jpg*

(Continued)

Primary Examiner — Robert M Spear

Assistant Examiner — Rhea Shields

(74) *Attorney, Agent, or Firm* — Whyte Hirschboeck Dudek S.C.

(57) **CLAIM**
An ornamental design for a container, as shown and described.

DESCRIPTION

FIG. 1 is a perspective view of first embodiment of my new design for a container that can be used to dispense a product, such as tissue;
FIG. 2 is a top view thereof;
FIG. 3 is a bottom view thereof;
FIG. 4 is a front view thereof;
FIG. 5 is a rear view thereof;
FIG. 6 is a first side view thereof;
FIG. 7 is a second side view thereof;
FIG. 8 is a perspective view of another embodiment of my new design for a container that can be used to dispense a product, such as tissue;
FIG. 9 is a front view thereof;
FIG. 10 is a rear view thereof;
FIG. 11 is a top view thereof;
FIG. 12 is a bottom view thereof;
FIG. 13 is a first side view thereof;
FIG. 14 is a second side view thereof.
FIG. 15 is a perspective view of another embodiment of my new design for a container that can be used to dispense a product, such as tissue;
FIG. 16 is a front view thereof;
FIG. 17 is a rear view thereof;
FIG. 18 is a top view thereof;
FIG. 19 is a bottom view thereof;
FIG. 20 is a first side view thereof;
FIG. 21 is a second side view thereof.
FIG. 22 is a perspective view of another embodiment of my new design for a container;
FIG. 23 is a top view thereof;
FIG. 24 is a bottom thereof;
FIG. 25 is a front view thereof;
FIG. 26 is a rear view thereof;
FIG. 27 is a first side view thereof; and,
FIG. 28 is a second side view thereof.
The broken lines shown in the figures are for illustrative environmental purposes only and form no part of the claimed design.

1 Claim, 12 Drawing Sheets

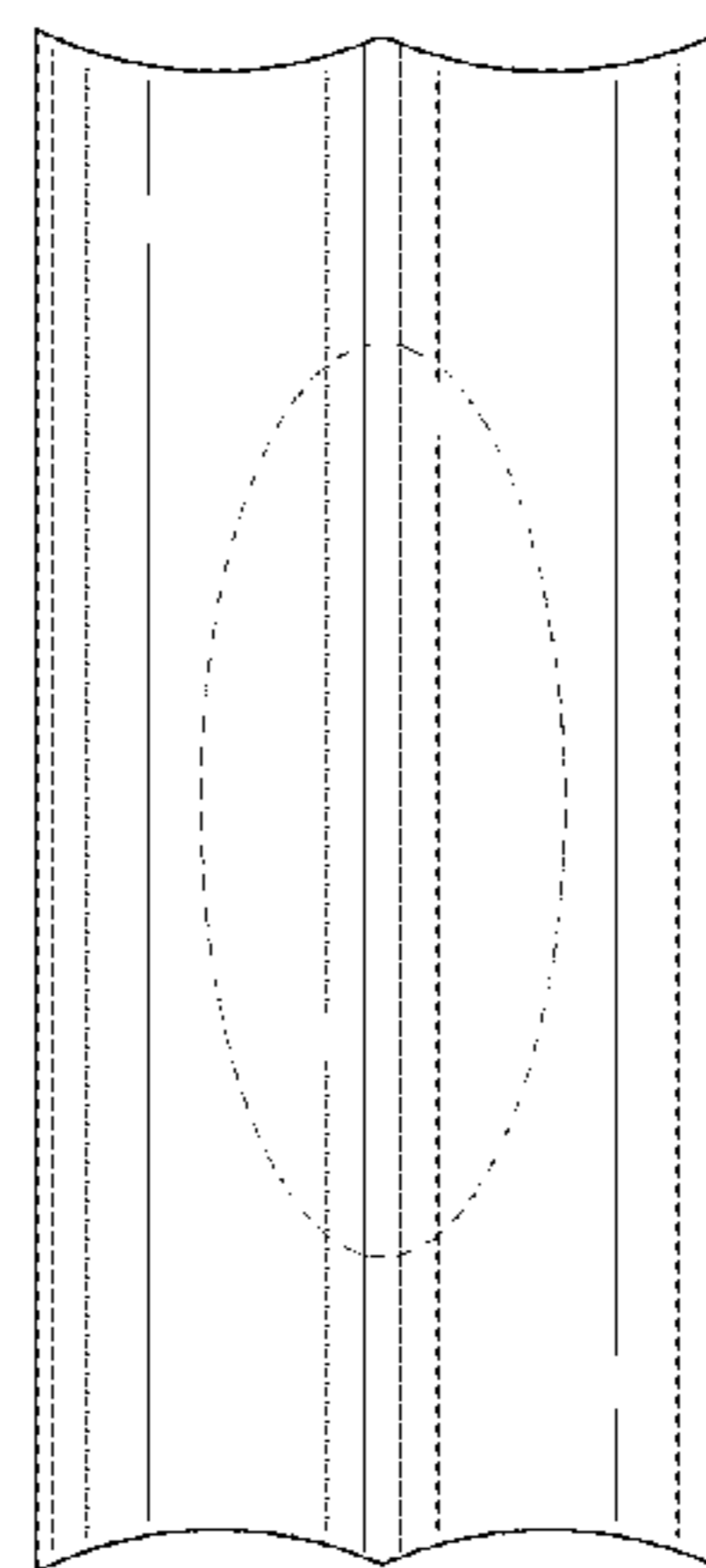
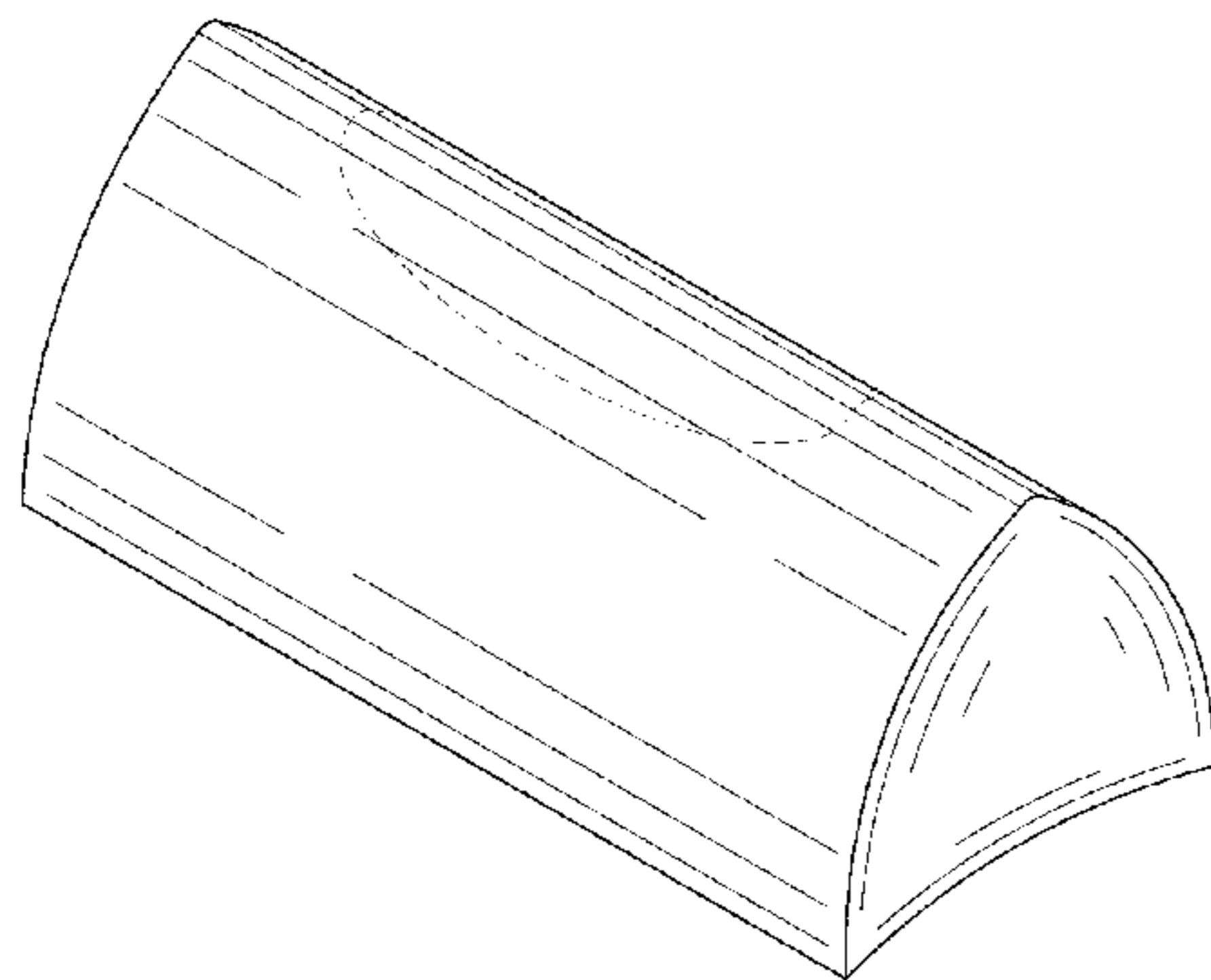

(56)

References Cited

U.S. PATENT DOCUMENTS

D231,201 S 4/1974 Bonfitto
 6,036,628 A 3/2000 Romer
 D438,105 S 2/2001 Conner et al.
 D439,838 S * 4/2001 Sagel et al. D9/430
 D442,083 S * 5/2001 Hoffman et al. D9/431
 D442,861 S * 5/2001 Sagel D9/430
 D454,305 S 3/2002 Bryan et al.
 D454,495 S 3/2002 Bryan et al.
 D459,221 S 6/2002 Springer et al.
 D461,404 S 8/2002 Steiger
 D477,780 S 7/2003 Springer et al.
 D486,731 S 2/2004 Meeker et al.
 D494,859 S 8/2004 Keberlein
 D495,247 S 8/2004 Keberlein
 6,800,357 B2 10/2004 Keberlein
 D504,812 S 5/2005 Keberlein
 D505,069 S 5/2005 Keberlein
 6,910,600 B2 6/2005 Keberlein
 6,948,625 B2 9/2005 Keberlein
 D514,928 S 2/2006 Keberlein
 D526,897 S 8/2006 Keberlein
 D528,435 S 9/2006 Keberlein
 D529,815 S * 10/2006 Frasier et al. D9/636

D546,675 S 7/2007 Keberlein
 D548,593 S 8/2007 Keberlein et al.
 D556,053 S 11/2007 Keberlein et al.
 D568,762 S 5/2008 Keberlein
 D568,763 S * 5/2008 Keberlein D9/734
 D575,635 S * 8/2008 Rozenzweig D9/418
 D591,172 S 4/2009 Keberlein et al.
 D591,618 S 5/2009 Keberlein et al.
 D596,022 S * 7/2009 van den Berg D9/416
 D672,233 S * 12/2012 Green D9/431
 D672,661 S * 12/2012 Hora et al. D9/734
 2005/0000976 A1 * 1/2005 Keberlein 221/63
 2010/0155410 A1 6/2010 Keberlein
 2011/0204081 A1 8/2011 Keberlein et al.

OTHER PUBLICATIONS

http://imgs.inkfrog.com/pix/77shop4w/triangle_bikini_pad_bra_inserts_front_001.JPG. *
 Design U.S. Appl. No. 29/401,919 entitled "Container"; filed with the United States Patent & Trademark Office on Sep. 16, 2011; 17 pages.
 Design U.S. Appl. No. 29/401,921 entitled "Container"; filed with the United States Patent & Trademark Office on Sep. 16, 2011; 11 pages.

* cited by examiner

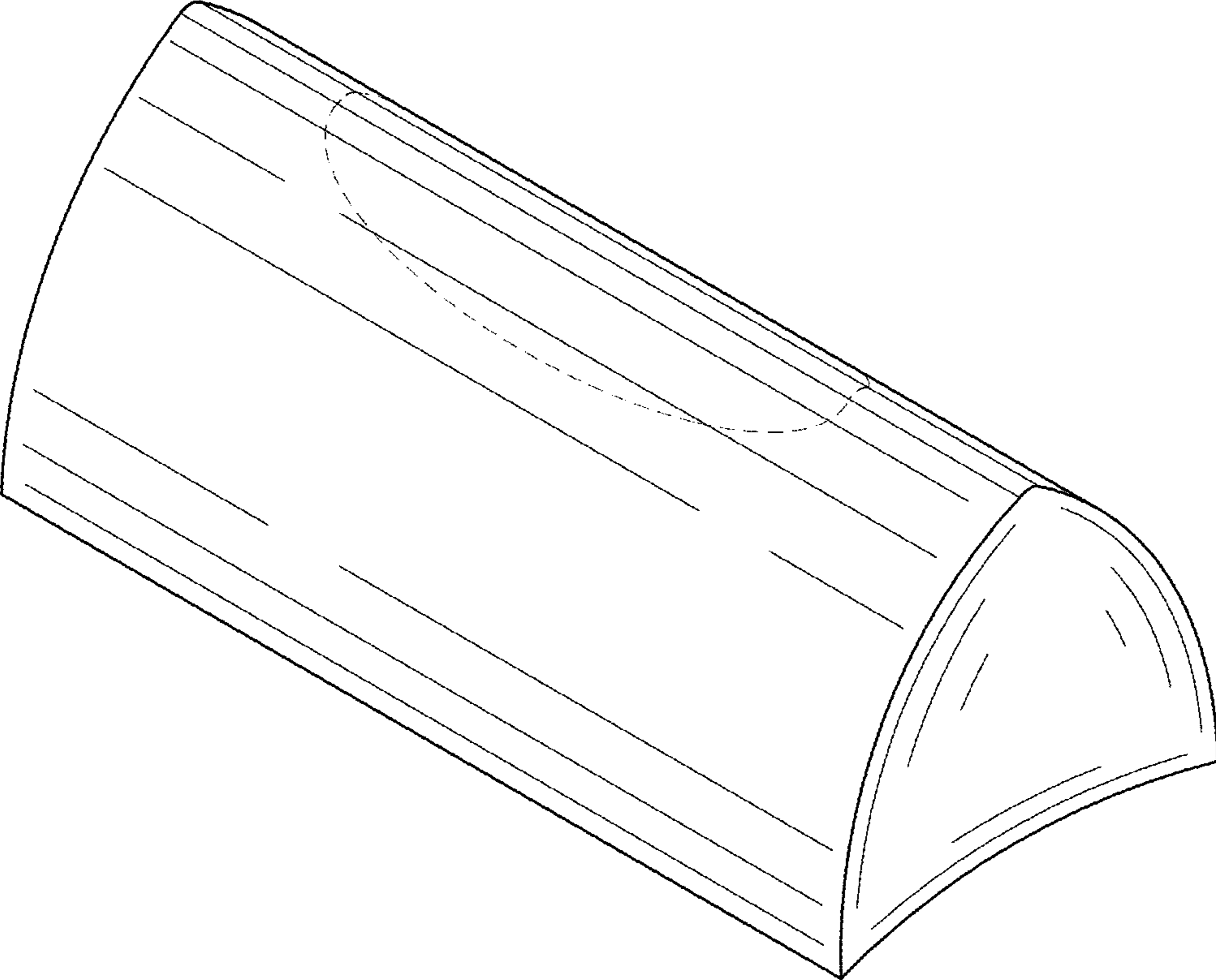

FIG. 1

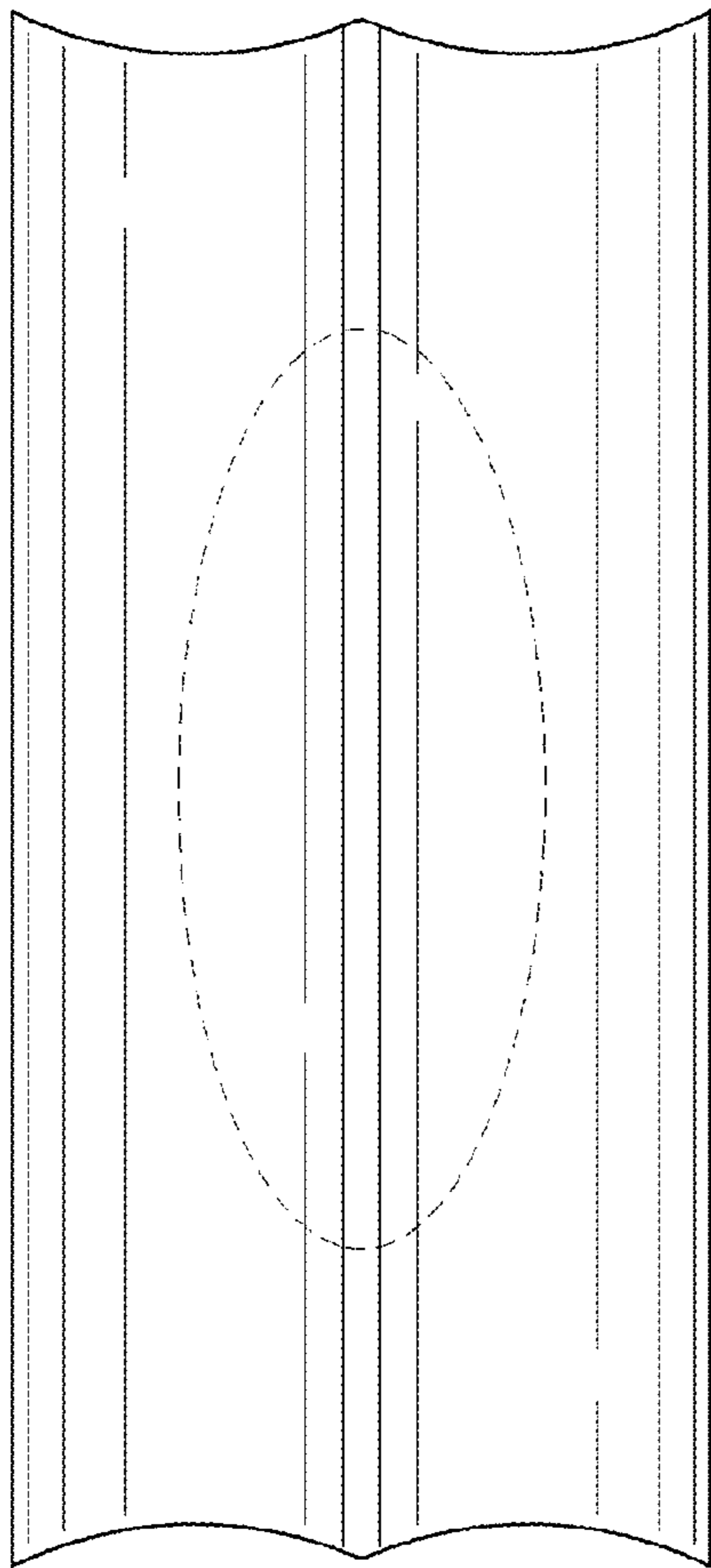

FIG. 2

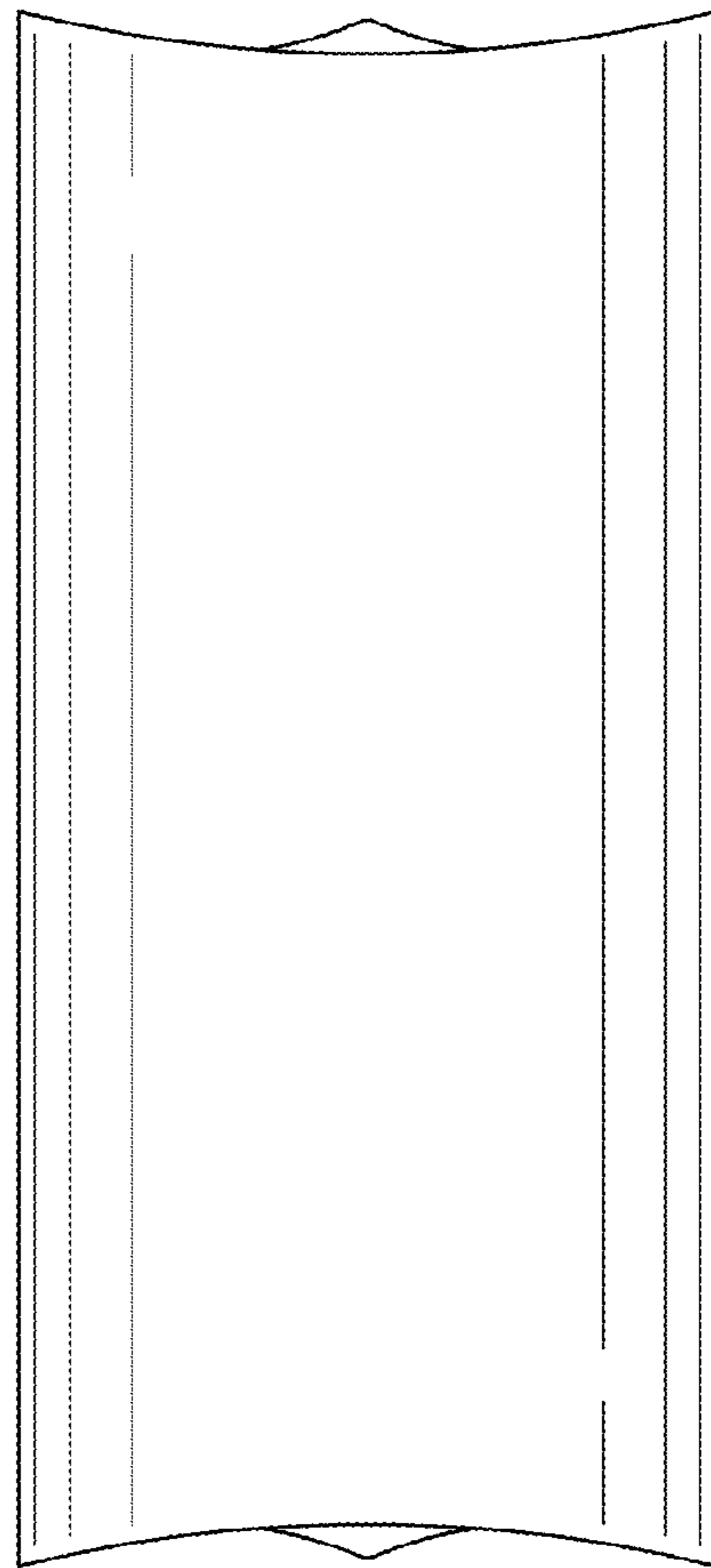

FIG. 3

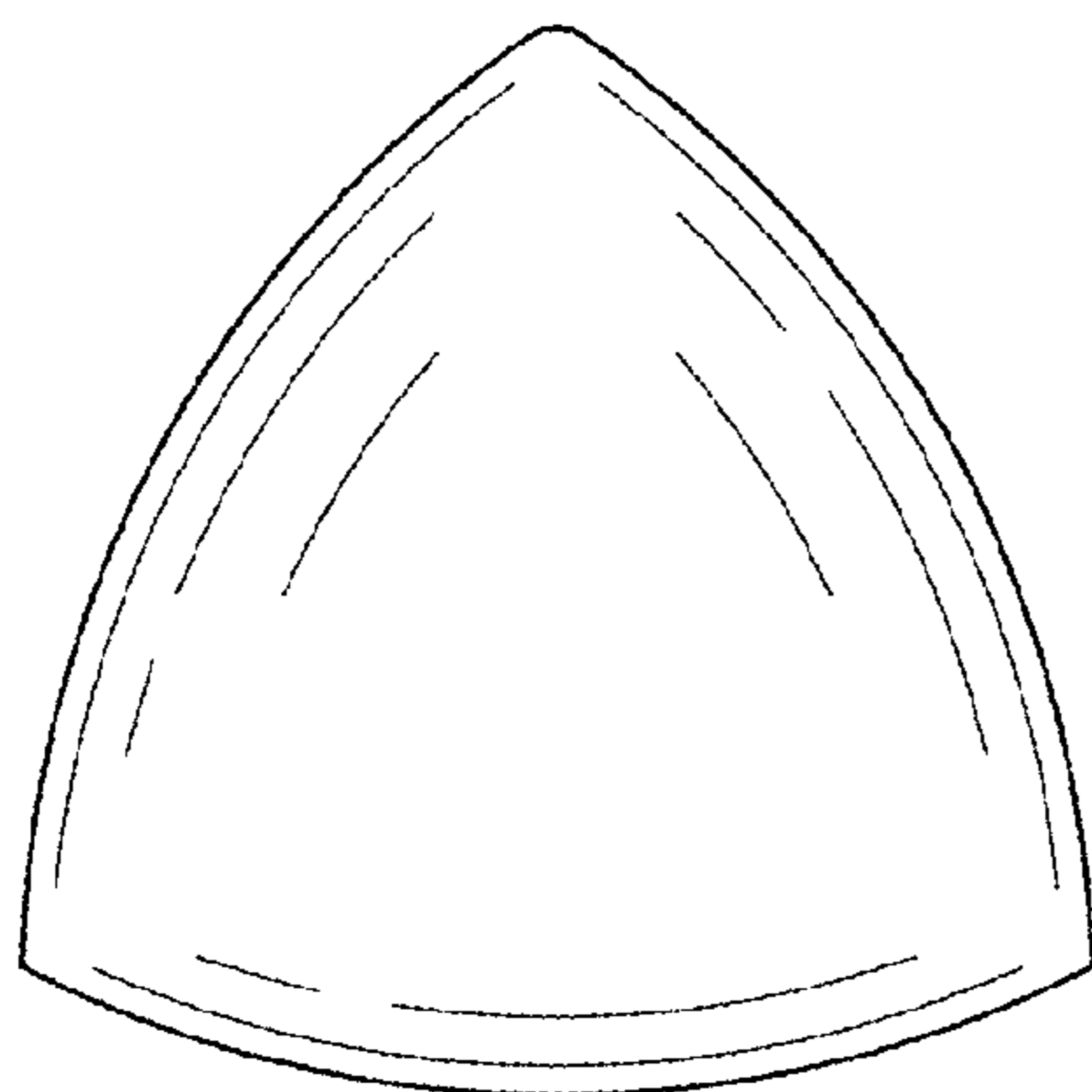

FIG. 4

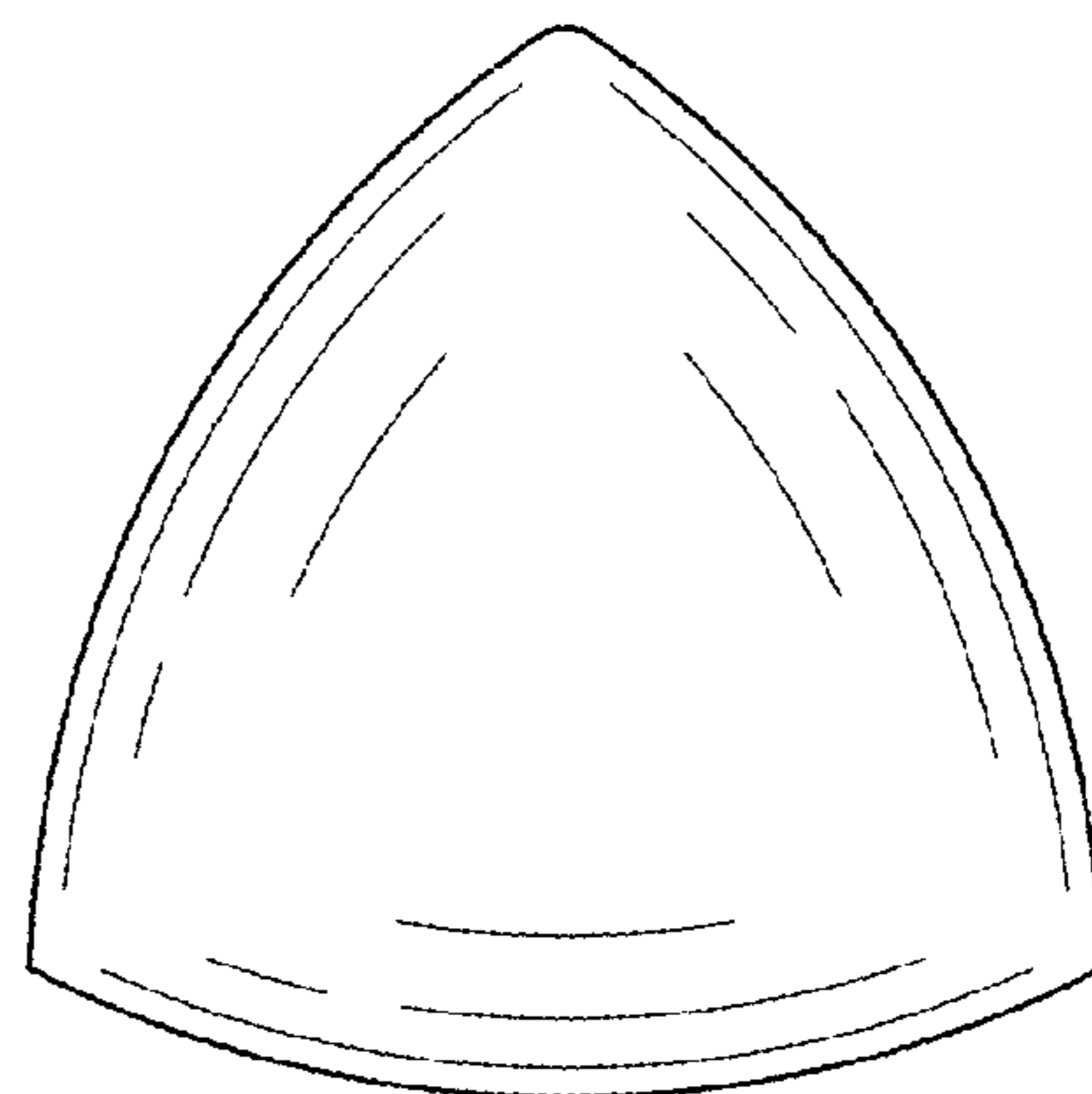

FIG. 5

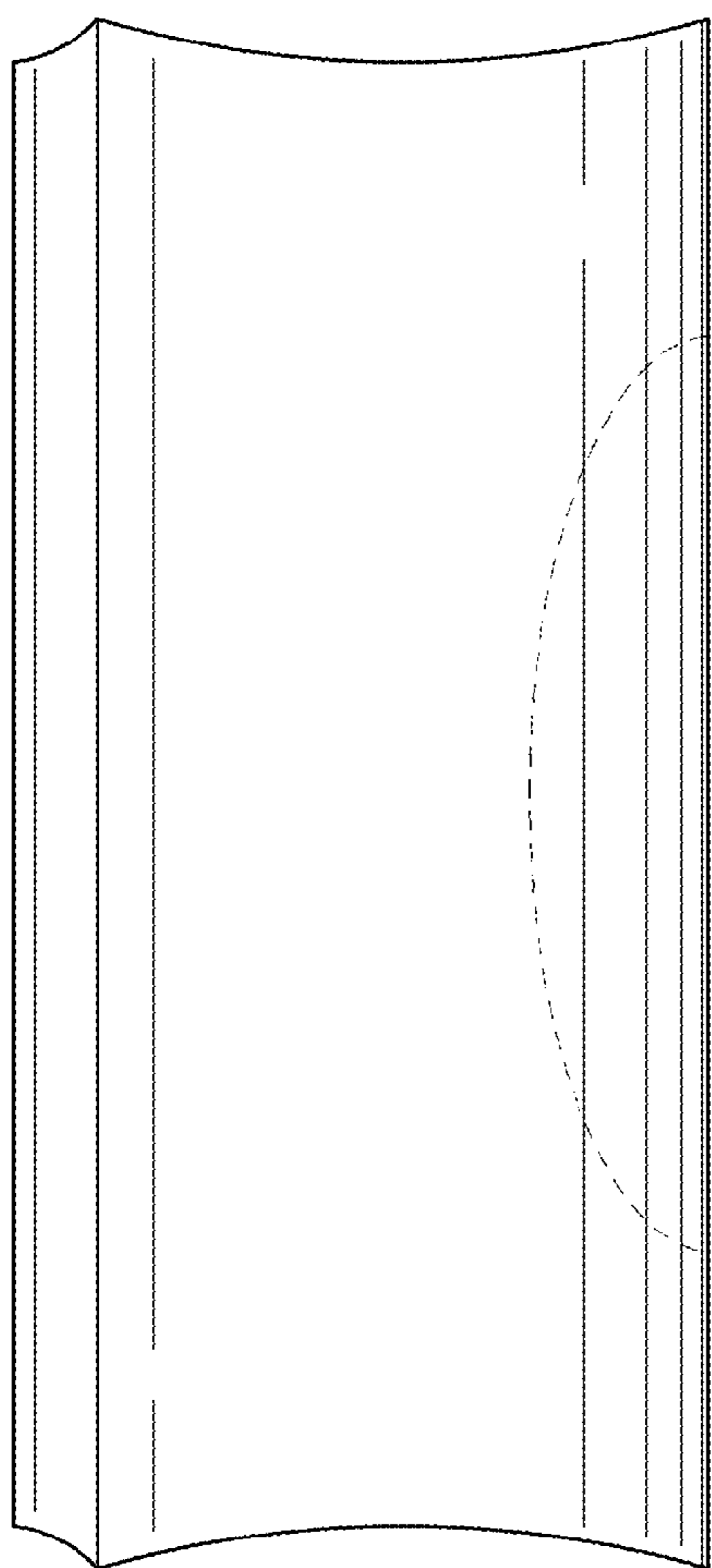

FIG. 6

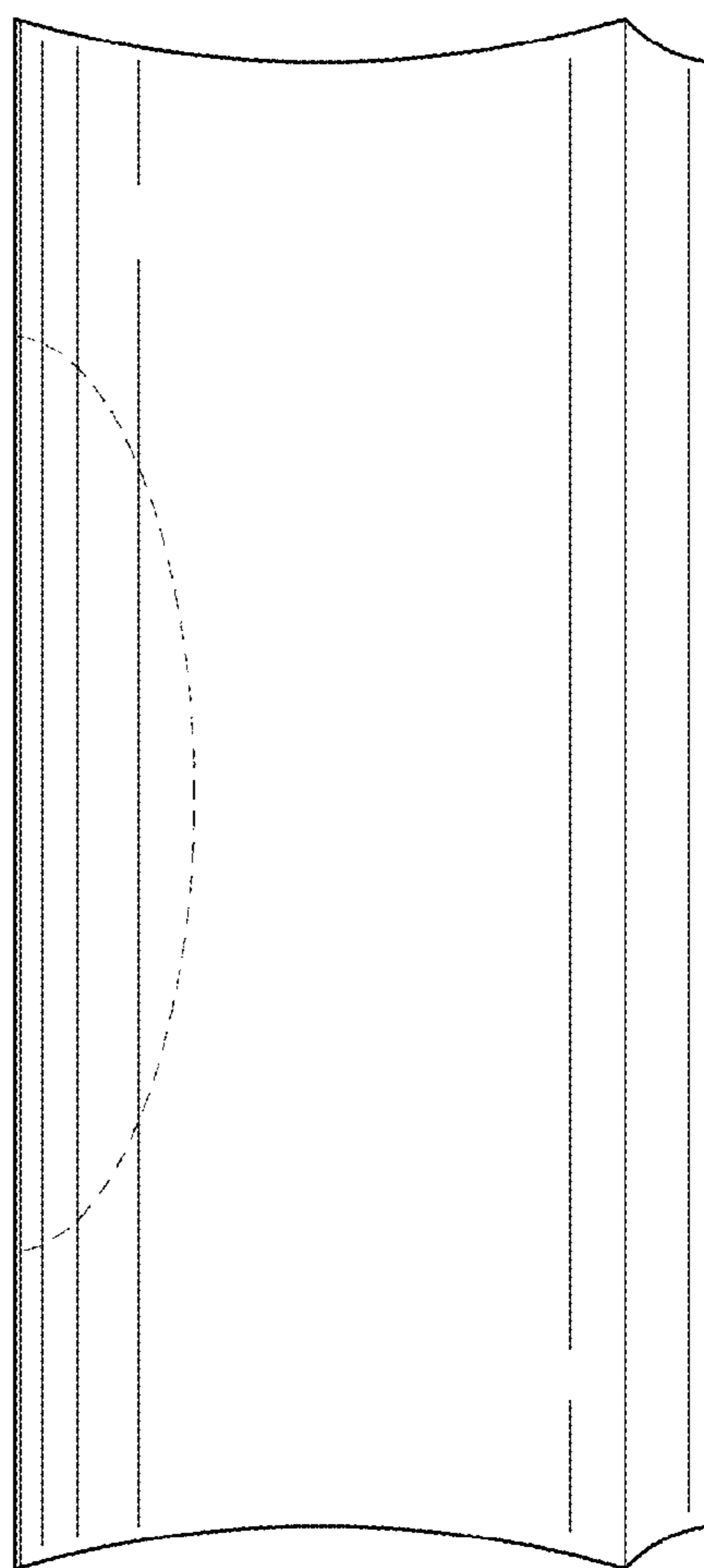

FIG. 7

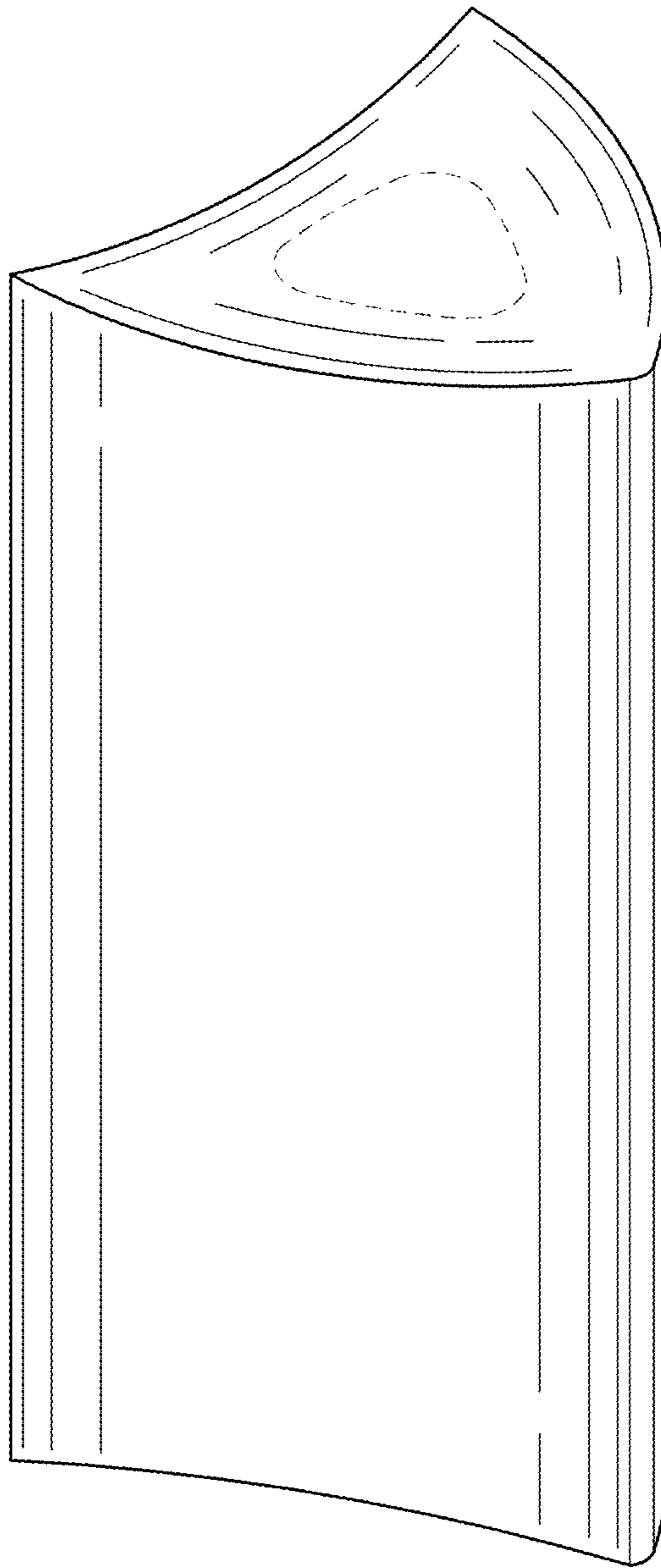

FIG. 8

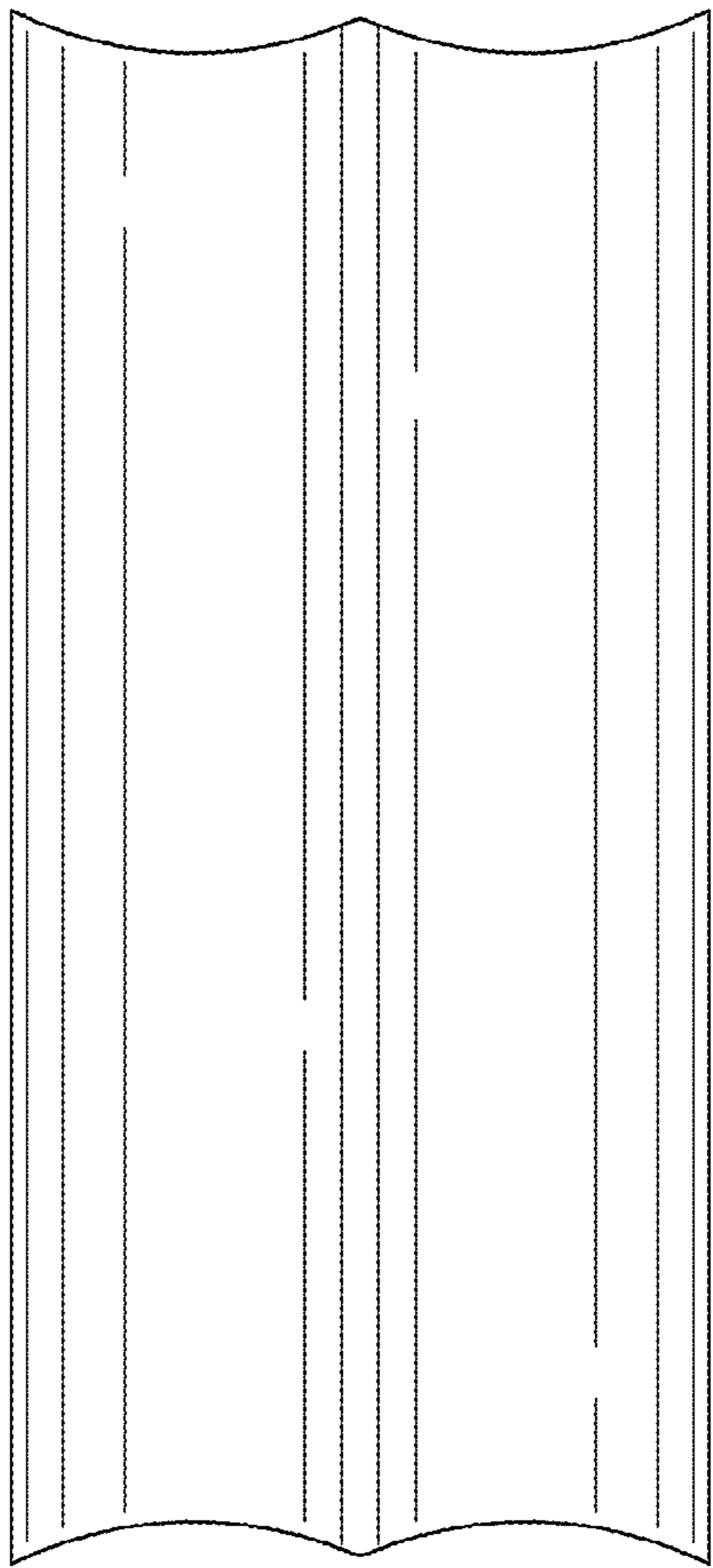

FIG. 9

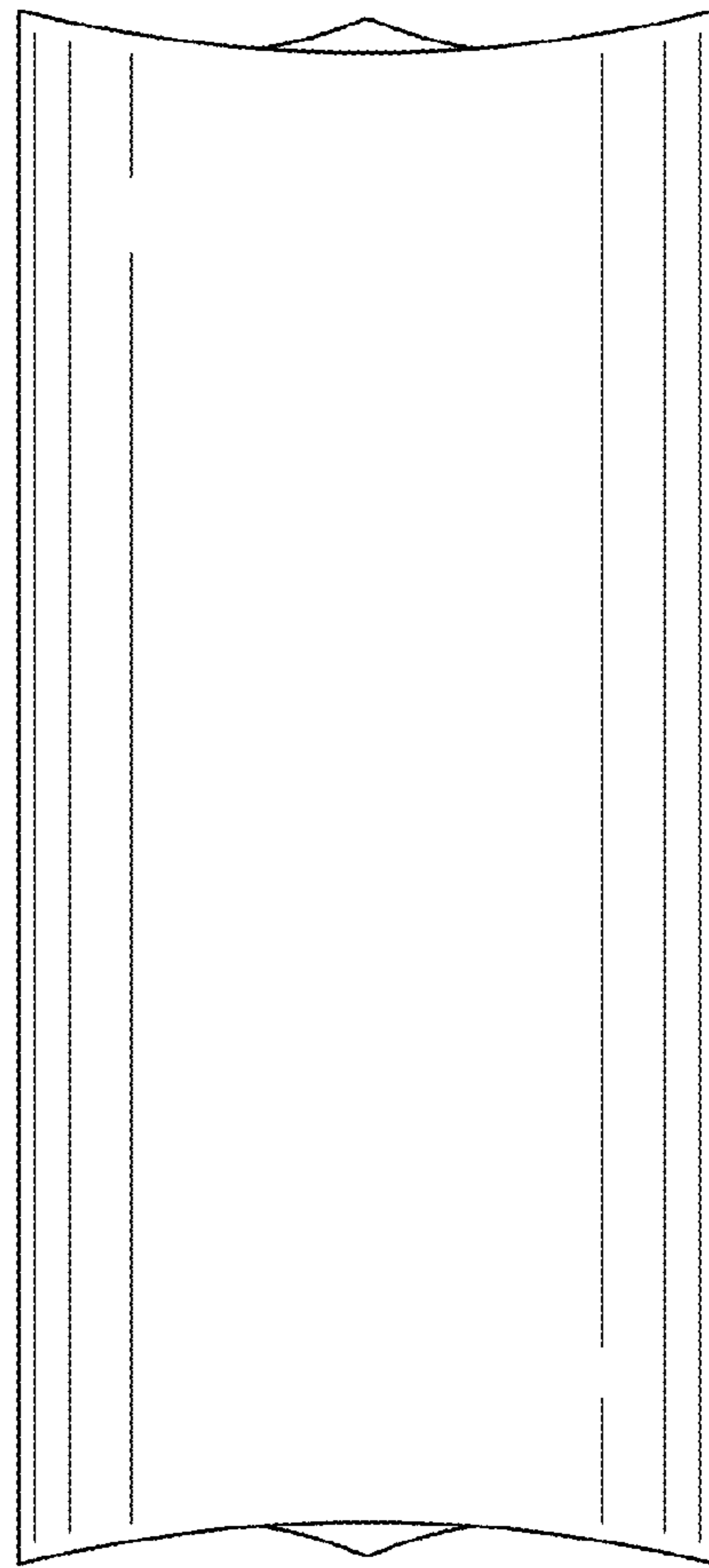

FIG. 10

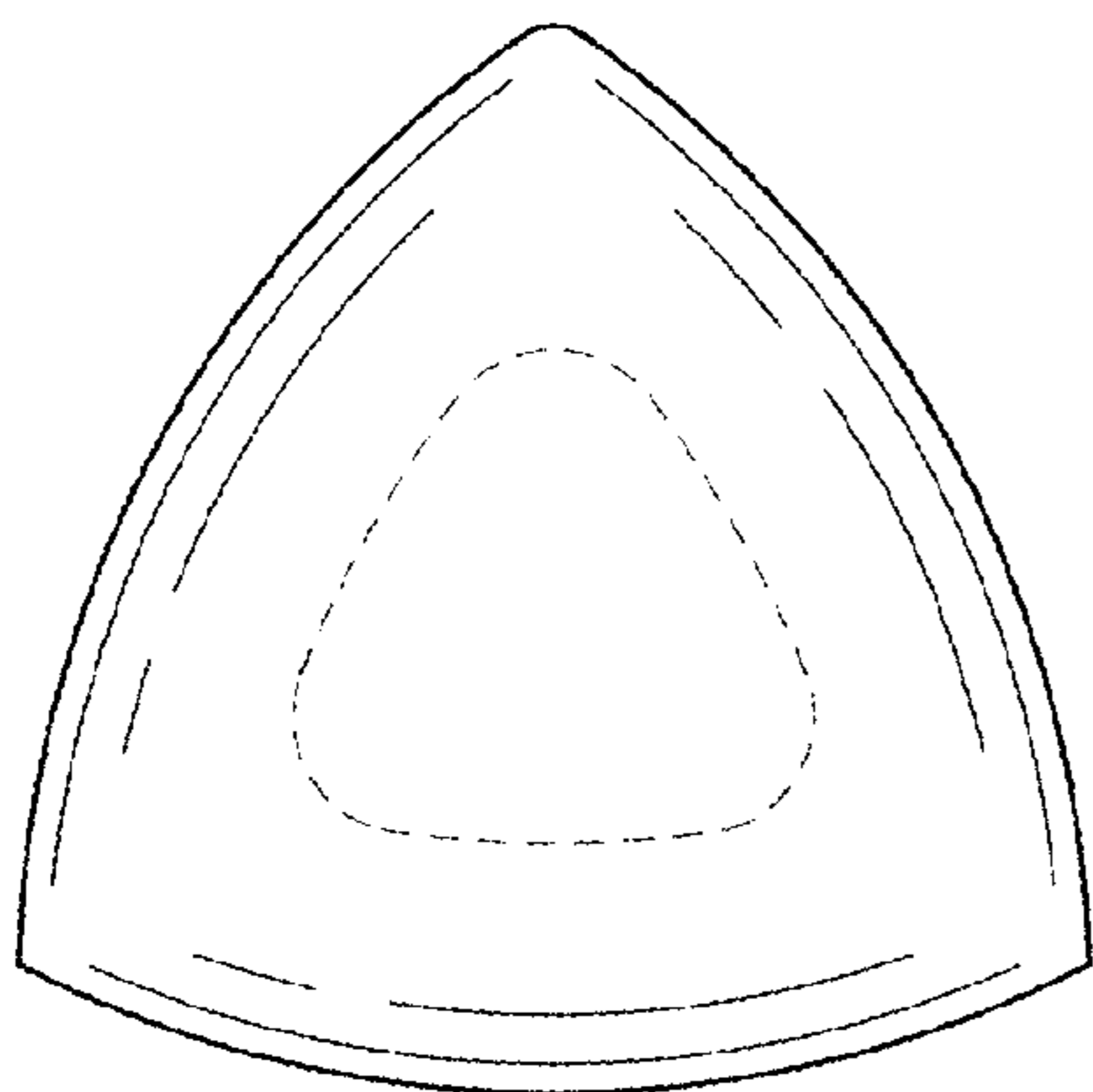

FIG. 11

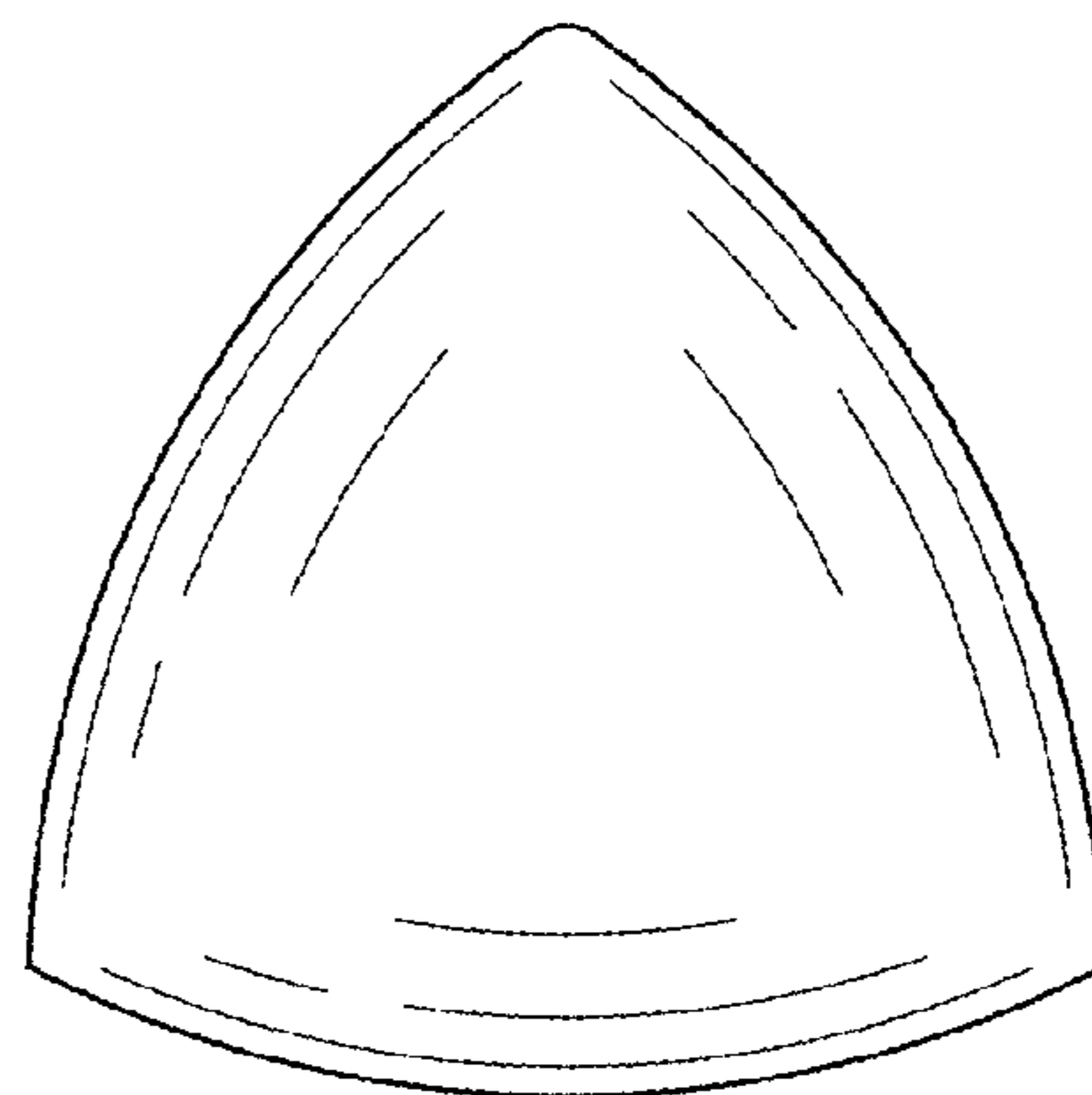

FIG. 12

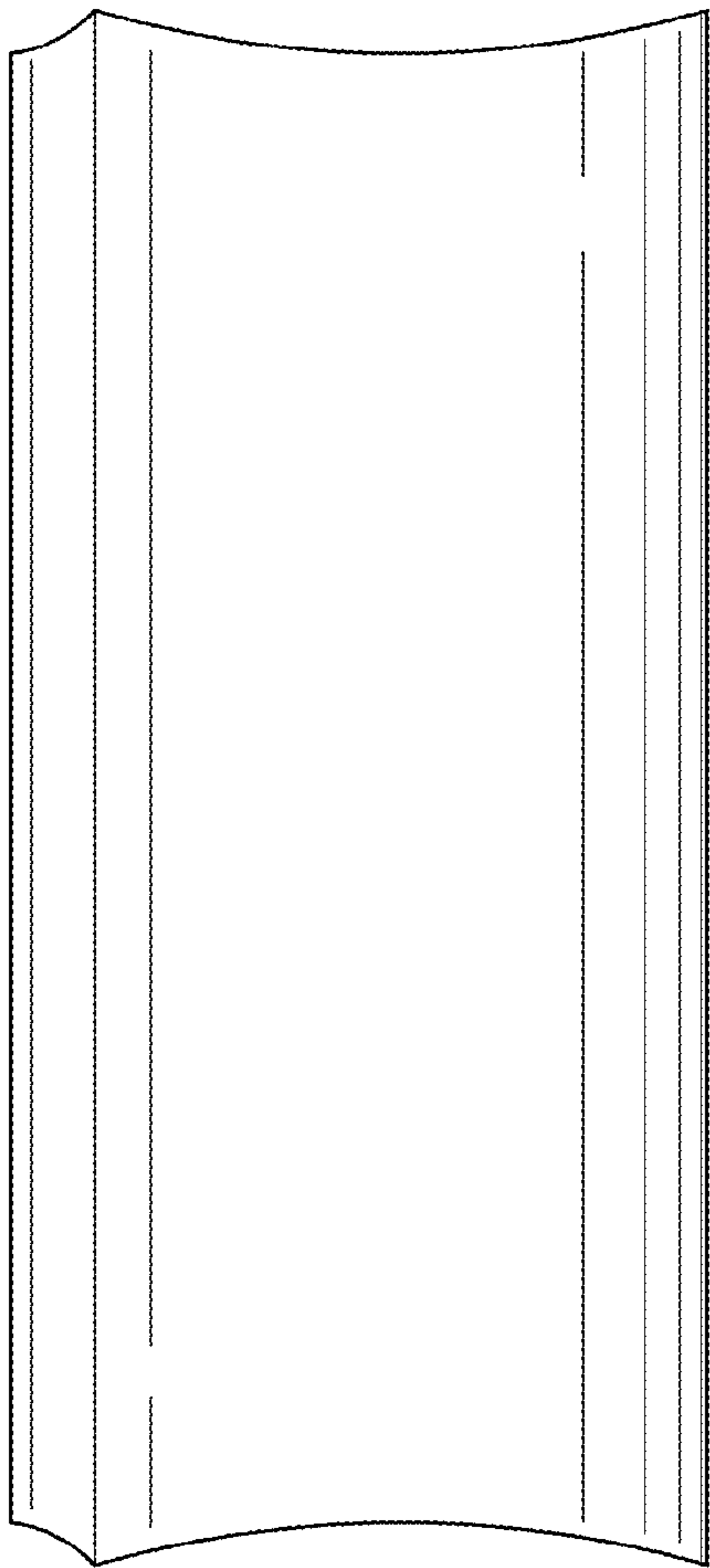

FIG. 13

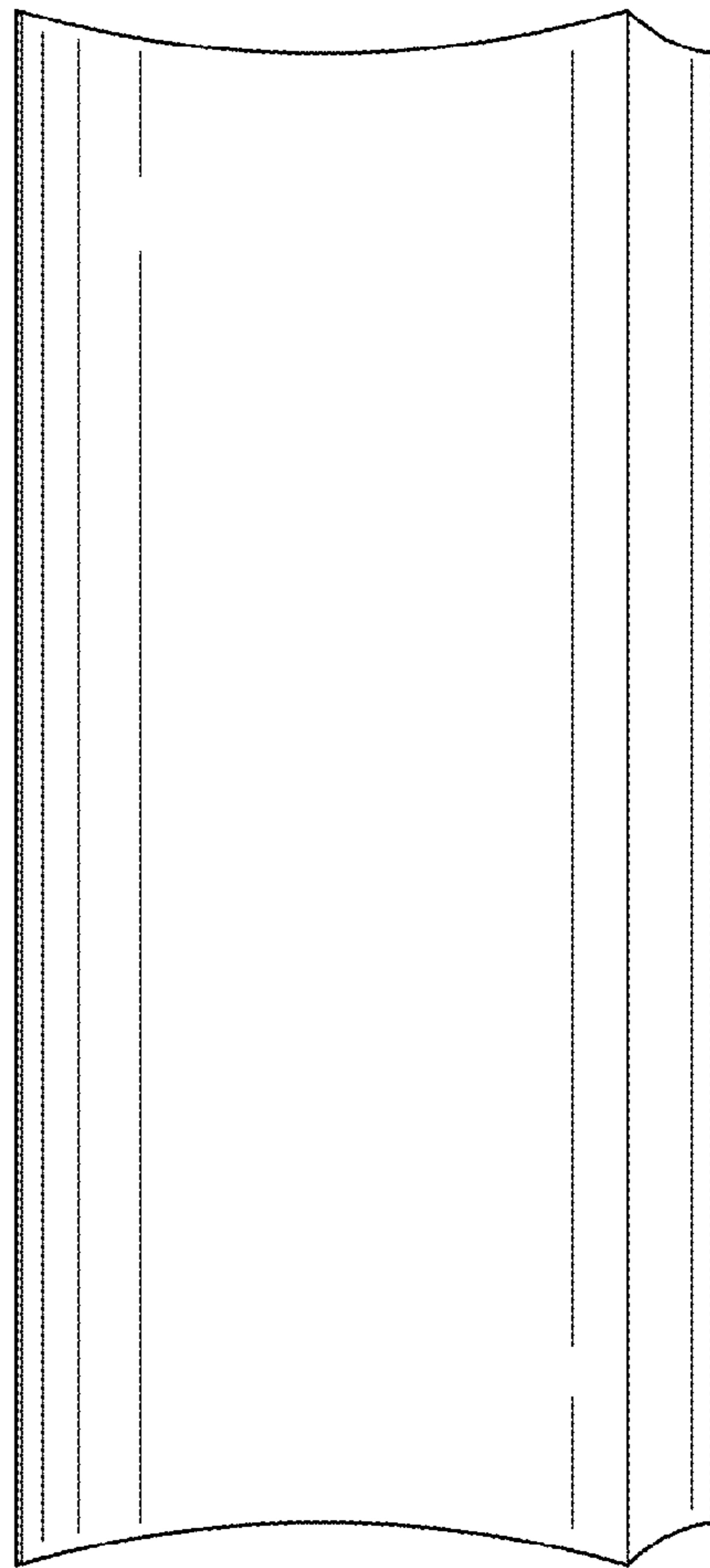

FIG. 14

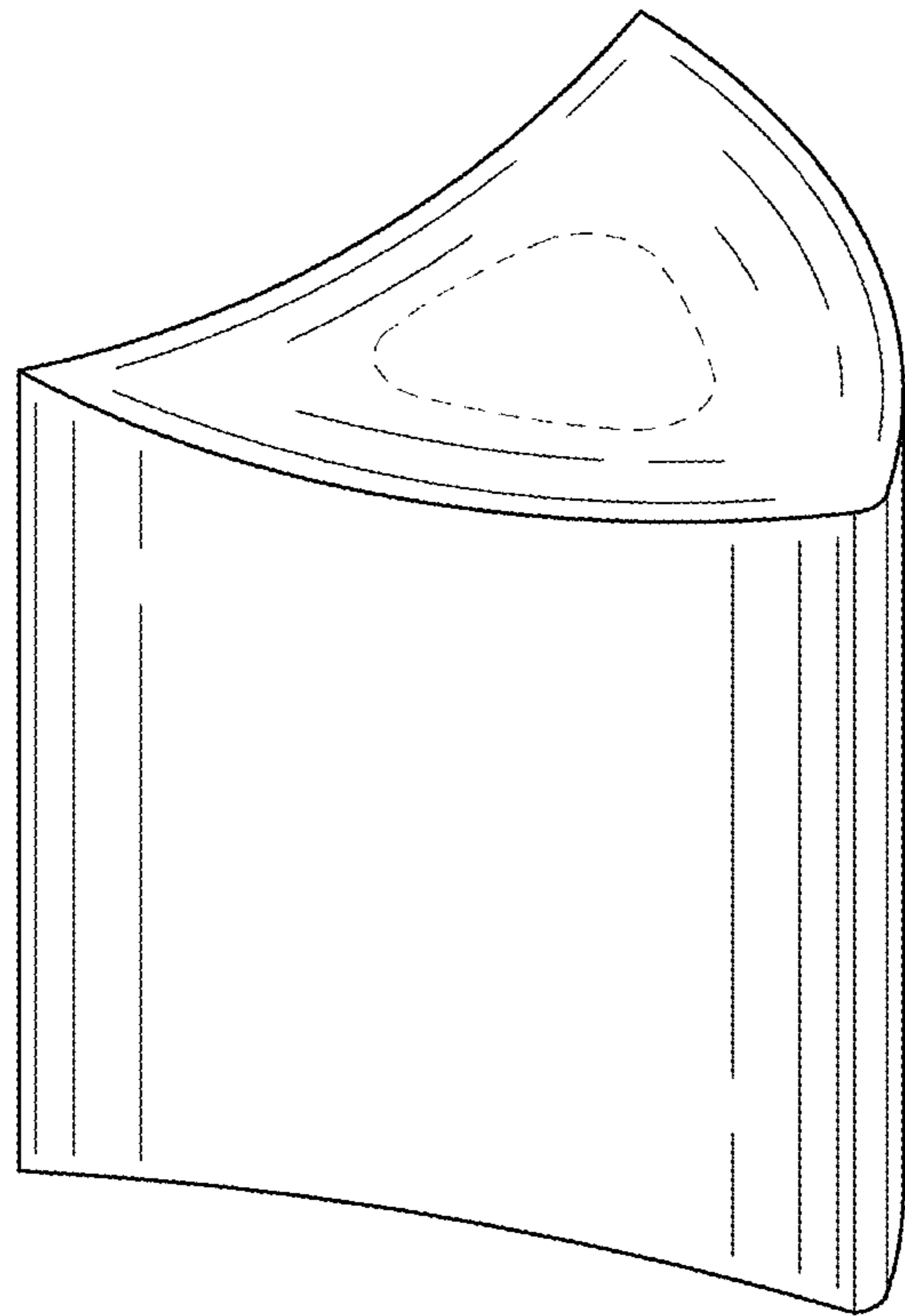

FIG. 15

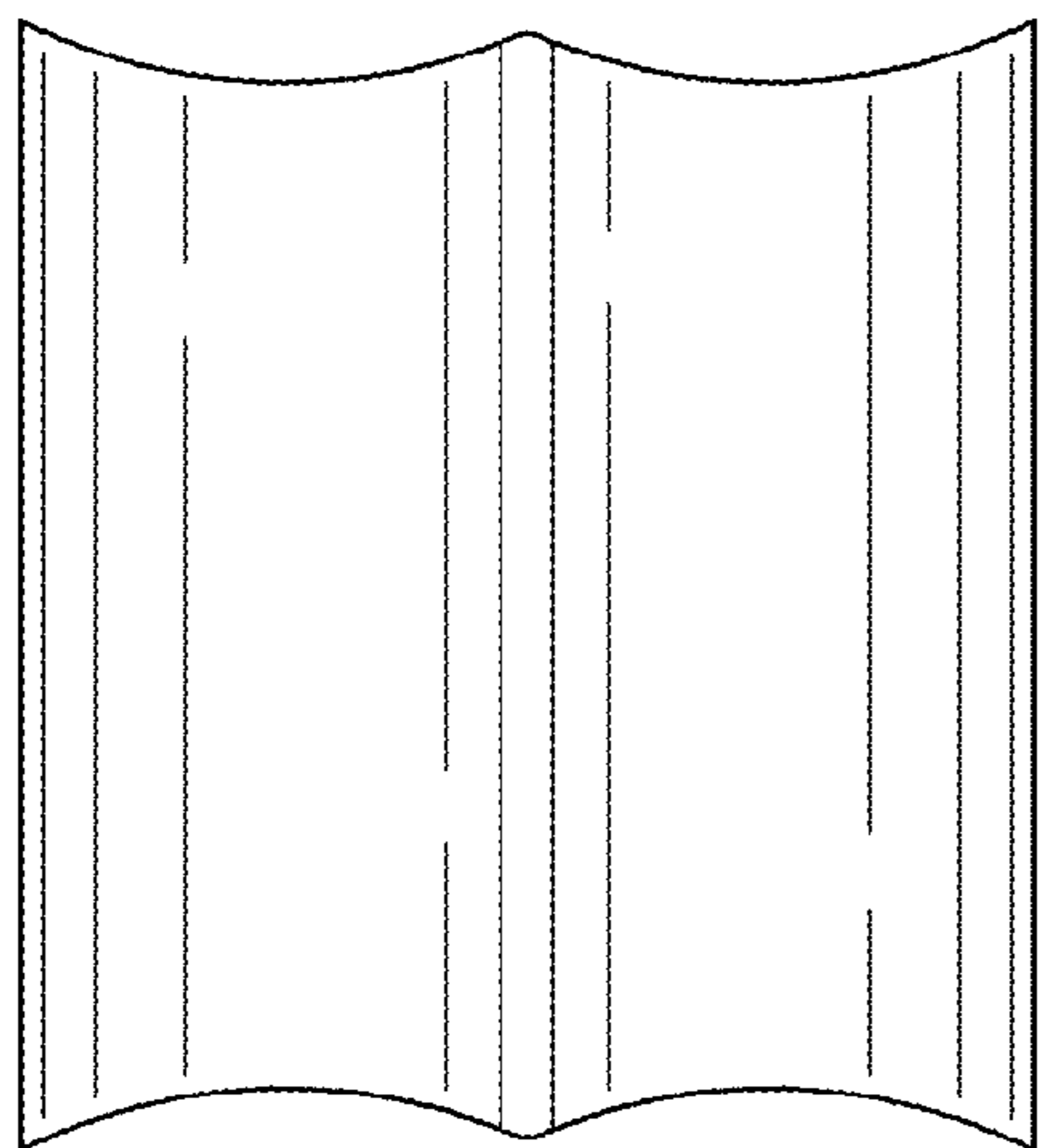

FIG. 16

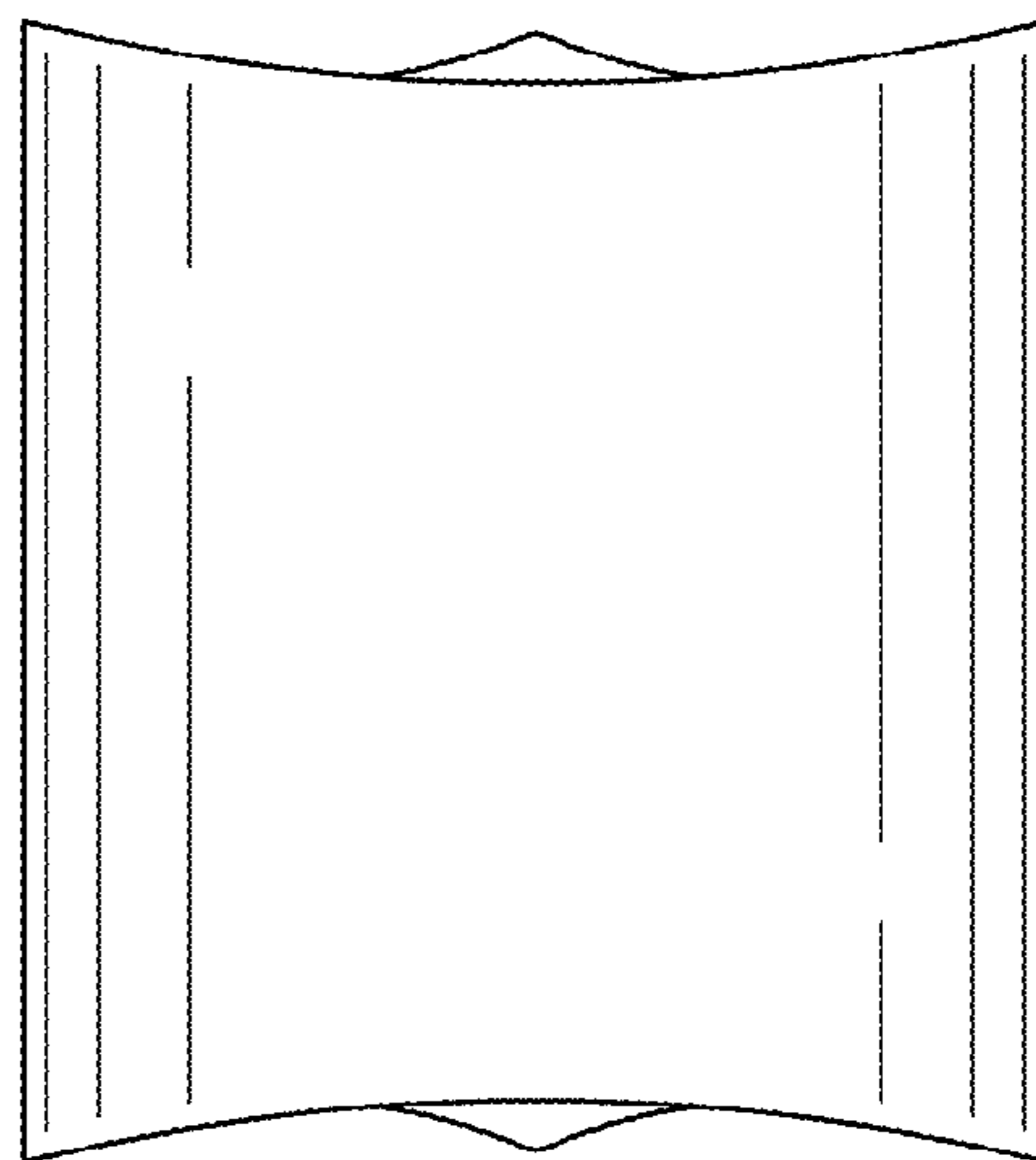

FIG. 17

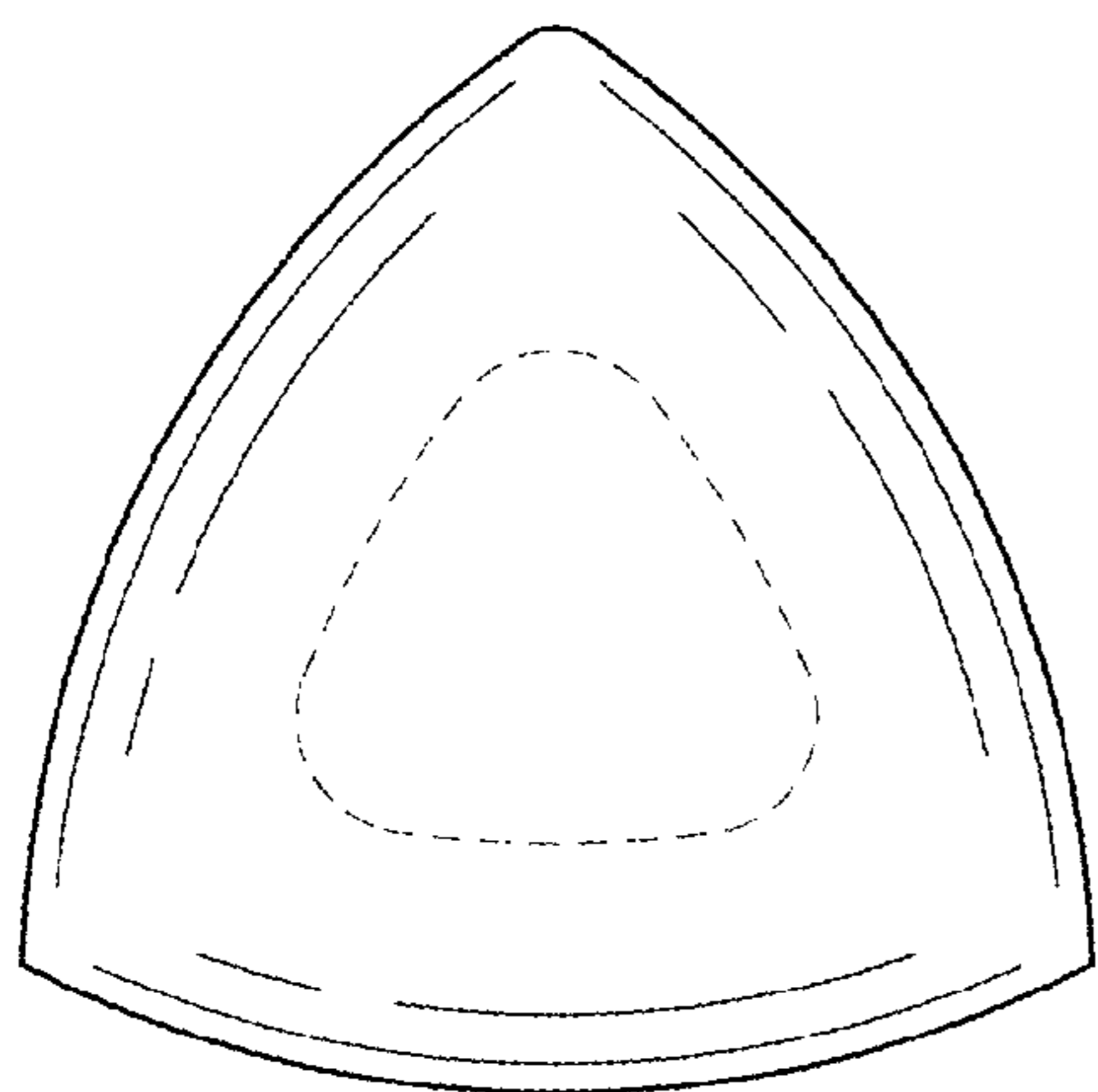

FIG. 18

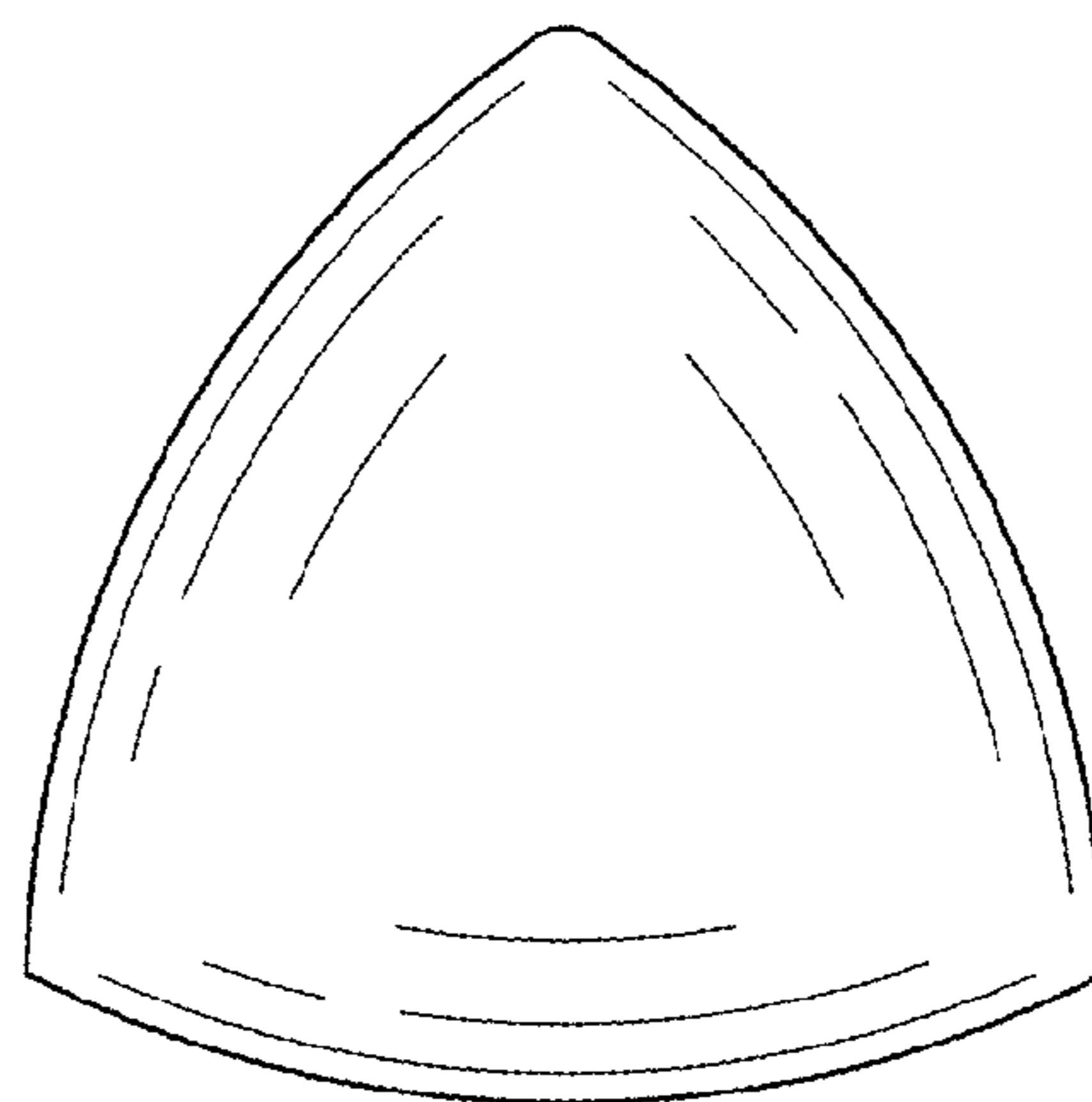

FIG. 19

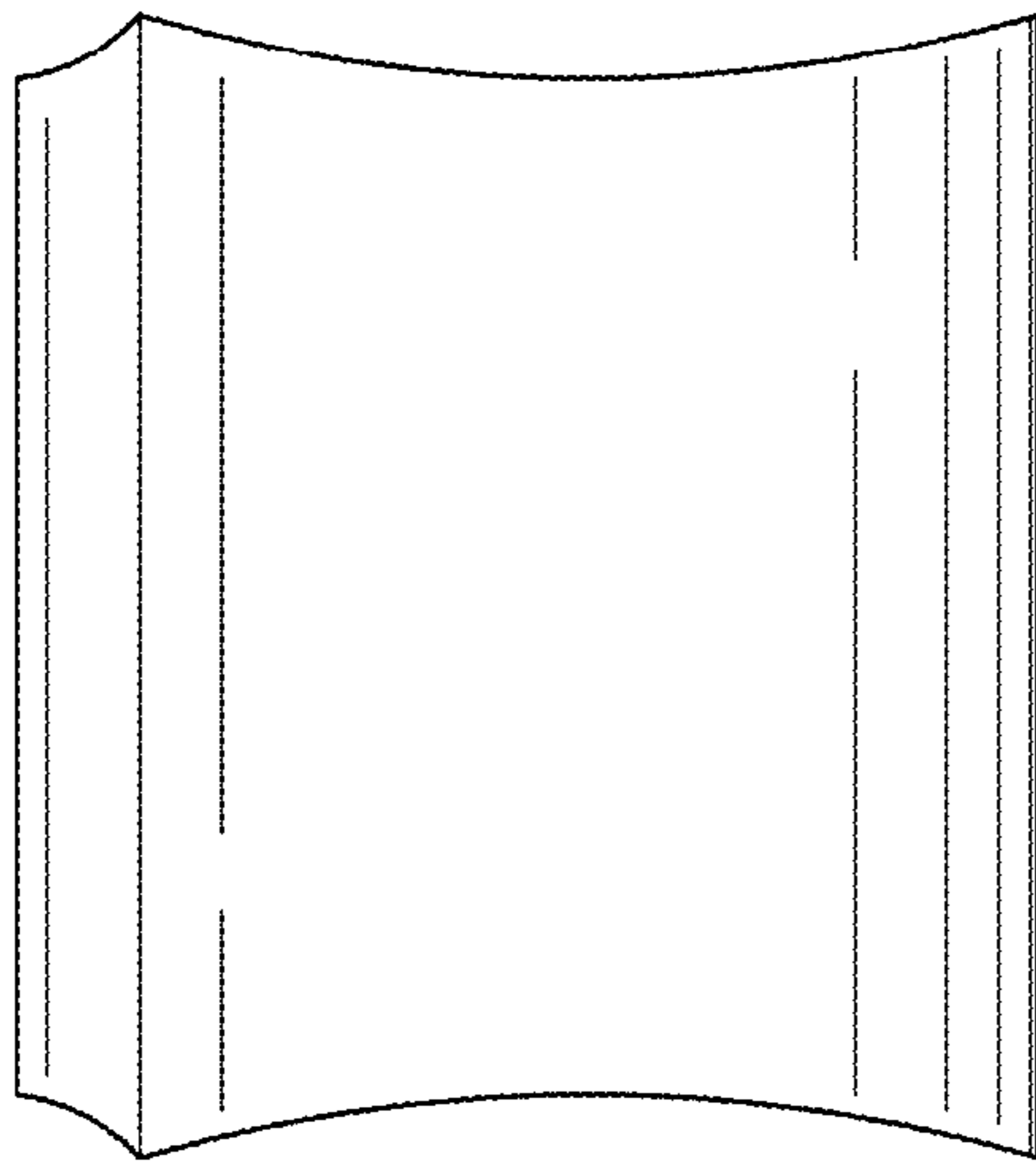

FIG. 20

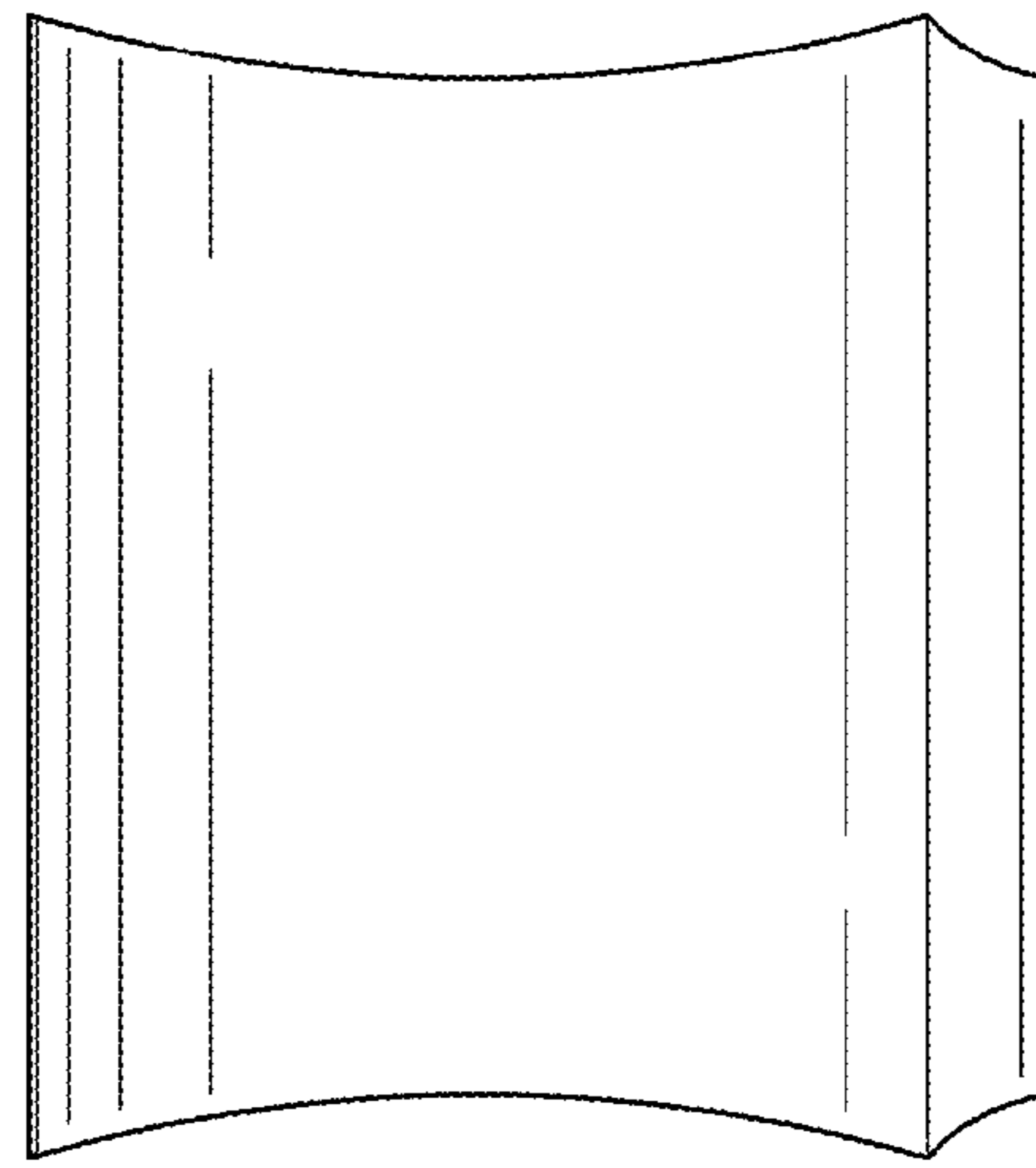

FIG. 21

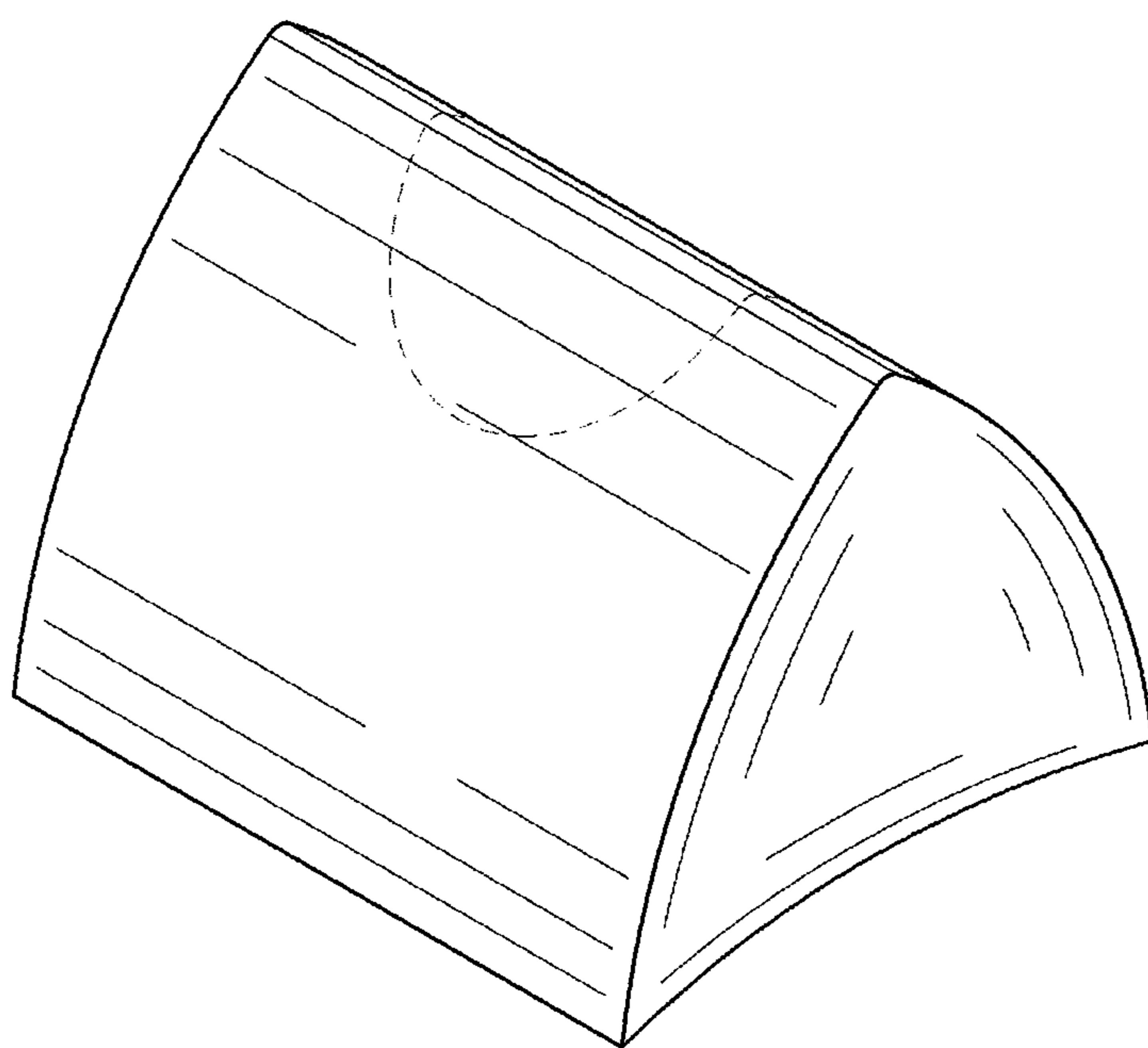

FIG. 22

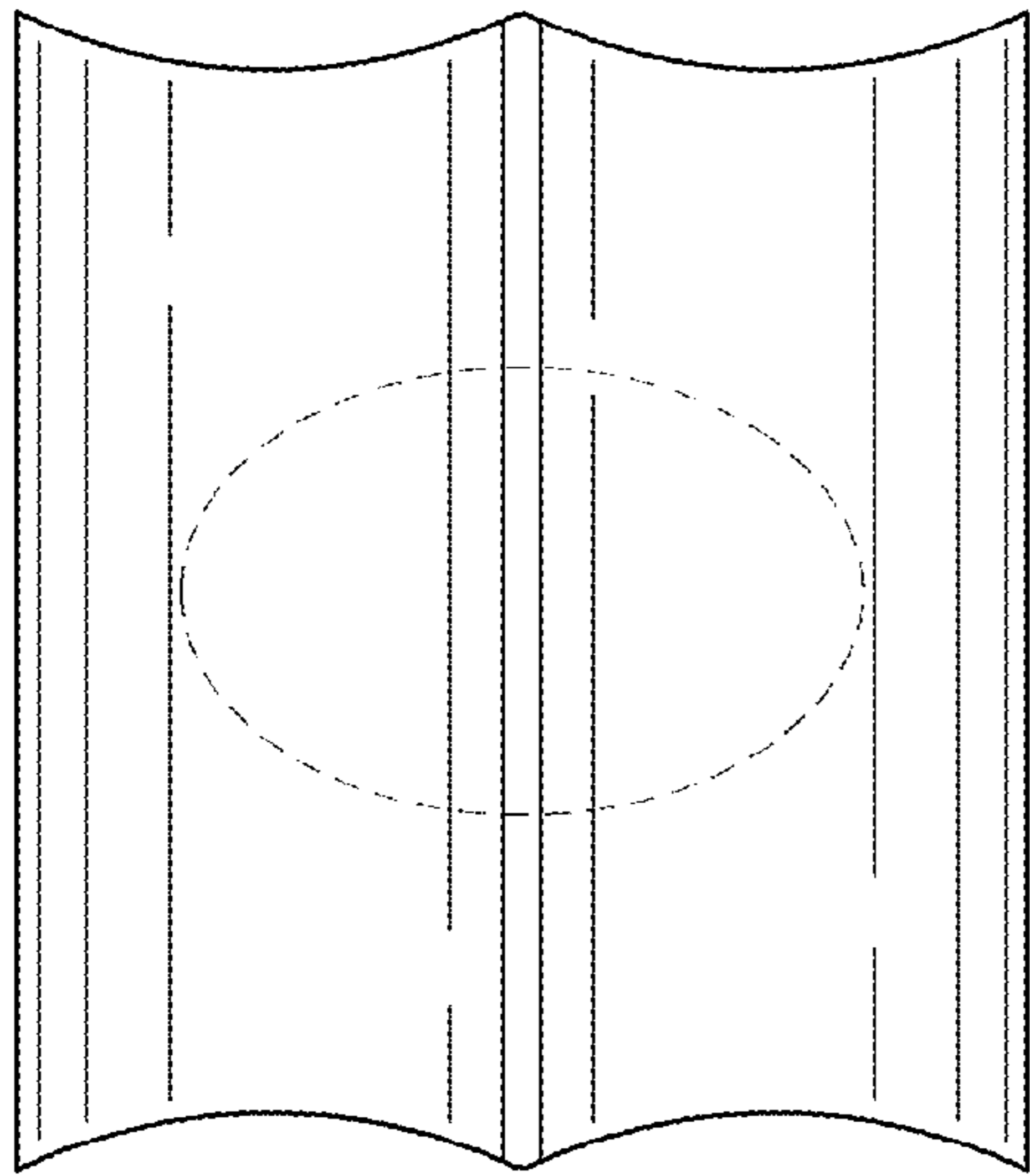

FIG. 23

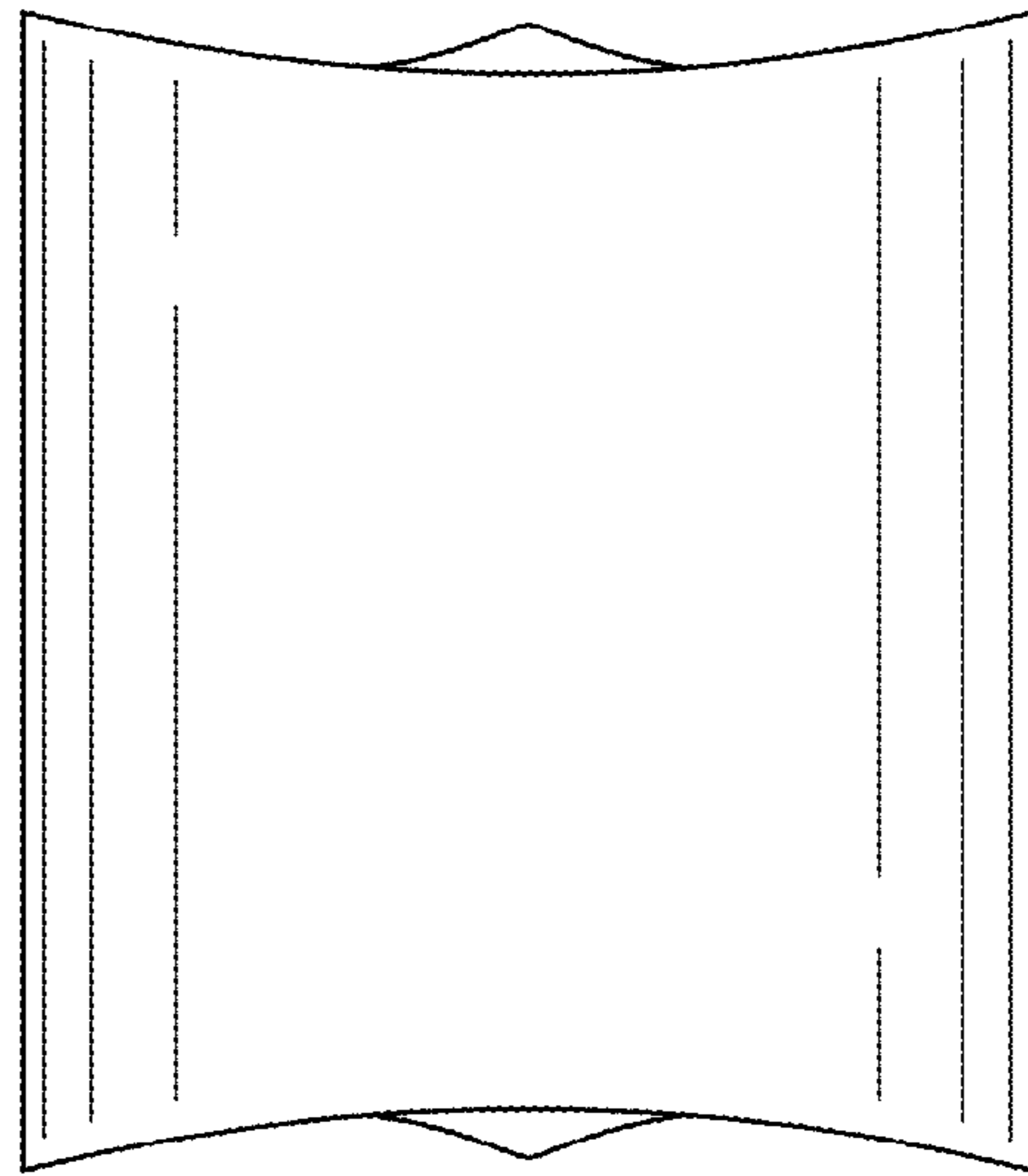

FIG. 24

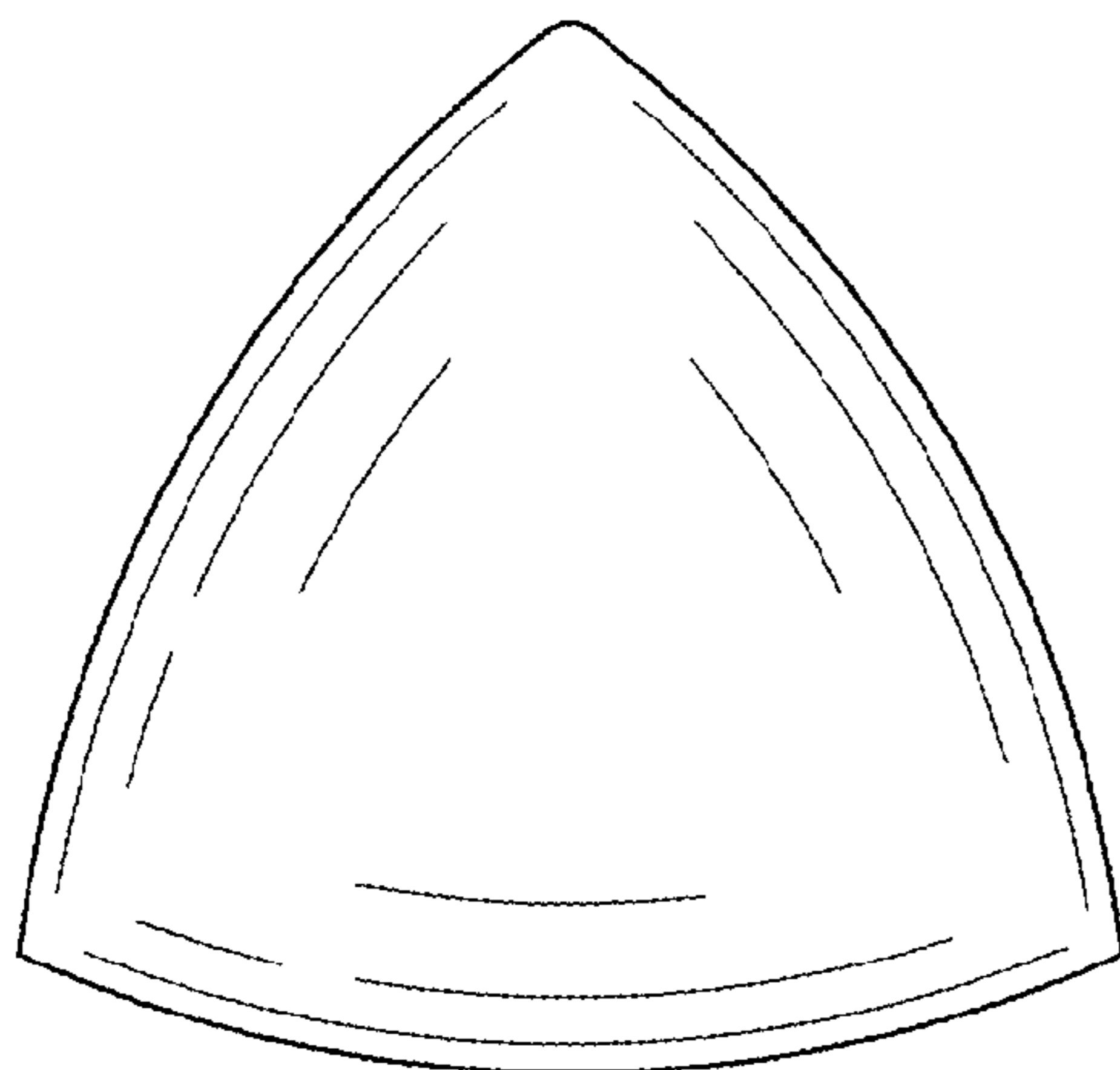

FIG. 25

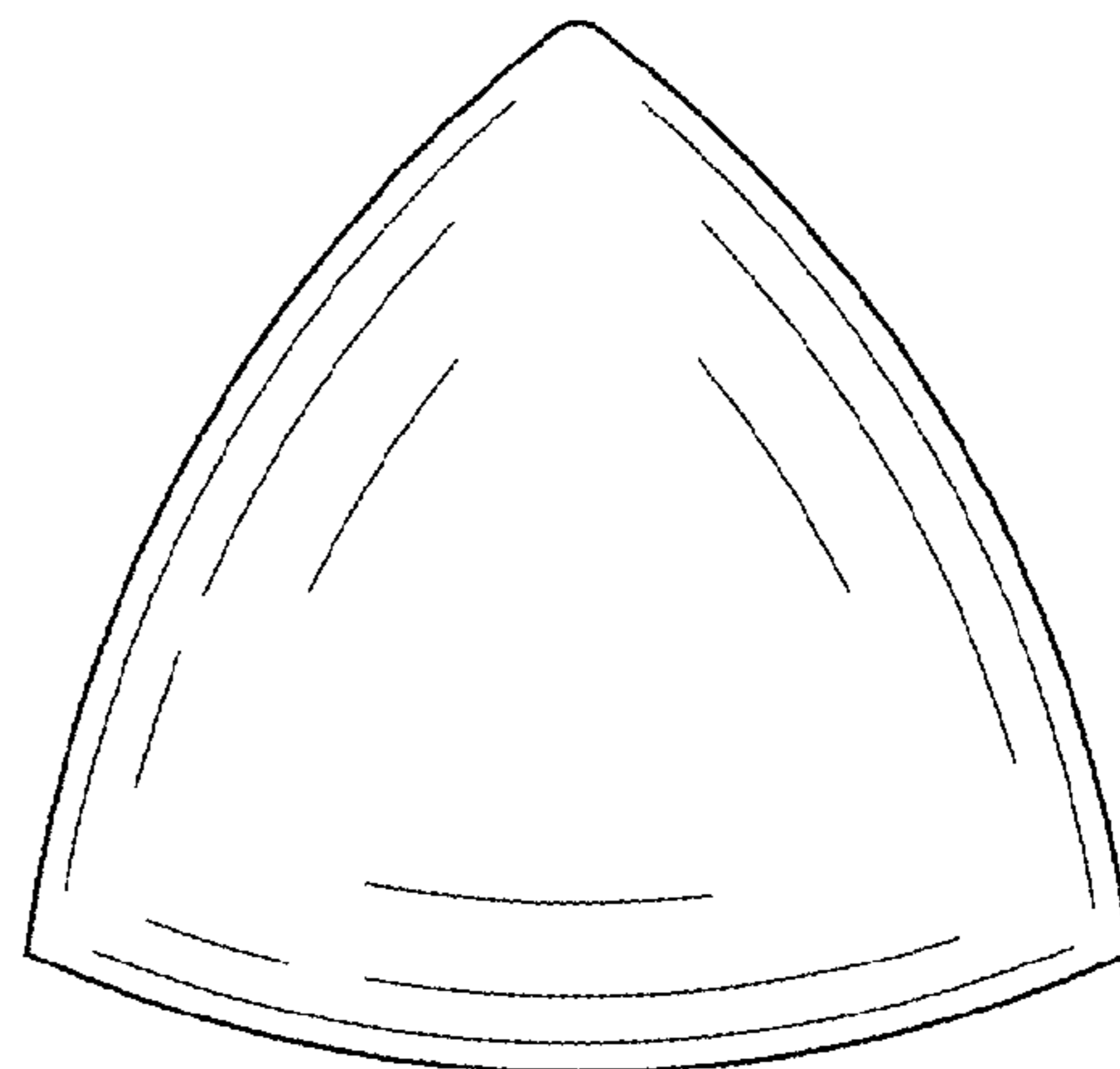

FIG. 26

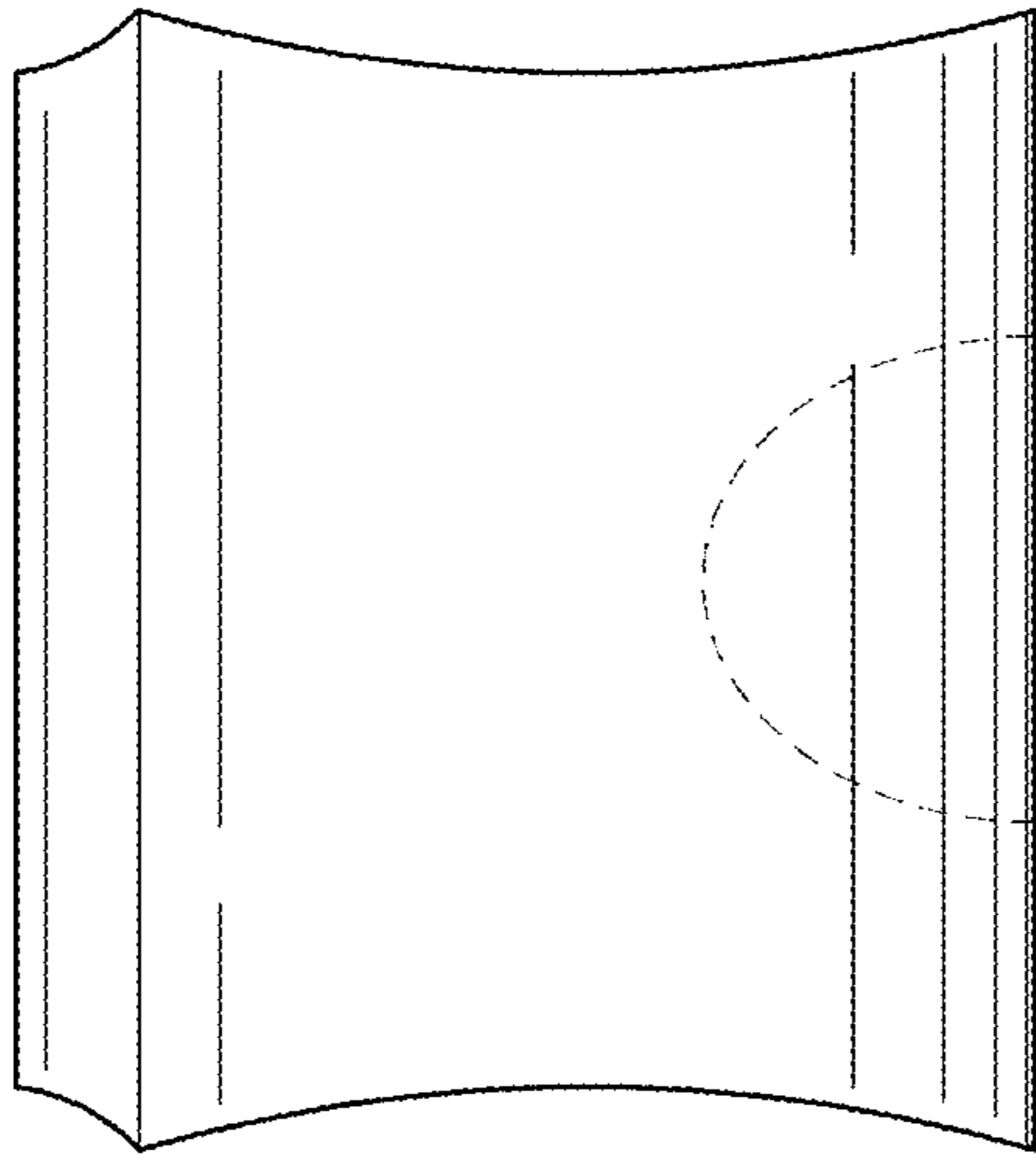

FIG. 27

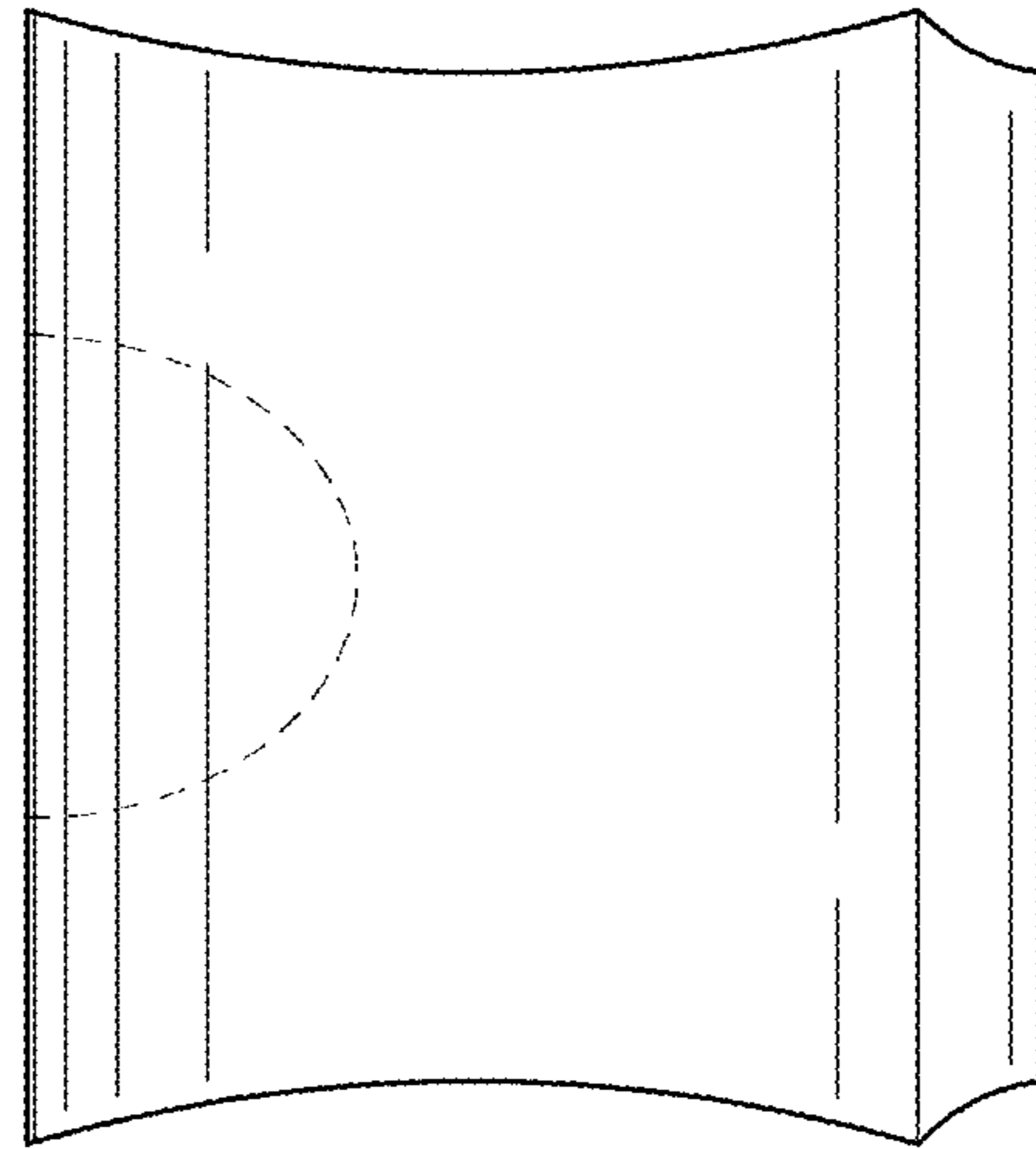

FIG. 28