



US00D694906S

(12) **United States Design Patent**  
**Priebe et al.**

(10) **Patent No.:** **US D694,906 S**  
(45) **Date of Patent:** **\*\* Dec. 3, 2013**

(54) **PILL FILL TRAY**

(71) Applicant: **Apothecary Products, Inc.**, Burnsville, MN (US)

(72) Inventors: **Robert N. Priebe**, Bloomington, MN (US); **Terrance O. Noble**, Burnsville, MN (US)

(73) Assignee: **Apothecary Products, Inc.**, Burnsville, MN (US)

(\*\*) Term: **14 Years**

(21) Appl. No.: **29/444,415**

(22) Filed: **Jan. 30, 2013**

(51) **LOC (9) Cl.** ..... **24-01**

(52) **U.S. Cl.**  
USPC ..... **D24/229**

(58) **Field of Classification Search**  
USPC ..... D24/185, 216–232, 127–128;  
D3/203.1–203.8, 304;  
D6/406.1–406.3, 406.6; D9/341, 345,  
D9/347, 348, 415, 418, 419, 430, 732;  
422/58, 99, 102, 104, 297, 400,  
422/560–564, 509, 942; 206/461–471, 526,  
206/528, 531–531, 534–539; 211/85.13,  
211/126.14, 174

See application file for complete search history.

(56) **References Cited**

**U.S. PATENT DOCUMENTS**

4,429,792	A	2/1984	Machbitz	
4,593,819	A *	6/1986	Will	206/538
4,664,262	A	5/1987	White	
D293,887	S	1/1988	Webster	
D320,930	S	10/1991	Richards	
D322,400	S	12/1991	Sorensen	
D322,934	S *	1/1992	Kalvelage	D9/732
D340,860	S *	11/1993	Gordon et al.	D24/226
D350,478	S *	9/1994	Fuller et al.	D3/203.3

5,346,069	A *	9/1994	Intini	206/531
D351,995	S *	11/1994	Kalvelage	D3/203.3
D411,445	S *	6/1999	Anderson	D3/203.3
D414,106	S	9/1999	Anderson	
6,023,916	A	2/2000	Bouthiette	
6,338,408	B1	1/2002	Anderson	
D454,781	S *	3/2002	Assargren et al.	D9/732
6,832,686	B2 *	12/2004	Donegan	206/531
D505,320	S *	5/2005	Gattefosse et al.	D9/430
D508,164	S *	8/2005	Coe et al.	D3/203.3
D513,863	S *	1/2006	Wahl et al.	D3/203.2
D514,309	S *	2/2006	Wahl et al.	D3/203.2

(Continued)

**OTHER PUBLICATIONS**

Exhibit A Apothecary Products, Inc. EZY Dose Memory Pac™ System Pill Dispenser Identification Card. Product publicly available prior to Feb. 25, 2005.

(Continued)

*Primary Examiner* — T. Chase Nelson

*Assistant Examiner* — Mark Cavanna

(74) *Attorney, Agent, or Firm* — Merchant & Gould P.C.

(57)

**CLAIM**

The ornamental design for pill fill tray, as shown and described.

**DESCRIPTION**

FIG. 1 is a perspective view of a pill fill tray showing my new design;

FIG. 2 is a top view thereof;

FIG. 3 is a bottom view thereof;

FIG. 4 is a right side view thereof;

FIG. 5 is a left side view thereof;

FIG. 6 is a front view thereof; and,

FIG. 7 is a rear view thereof.

The broken lines are included for the purpose of illustrating portions of the pill fill tray that form no part of the claimed design.

**1 Claim, 5 Drawing Sheets**

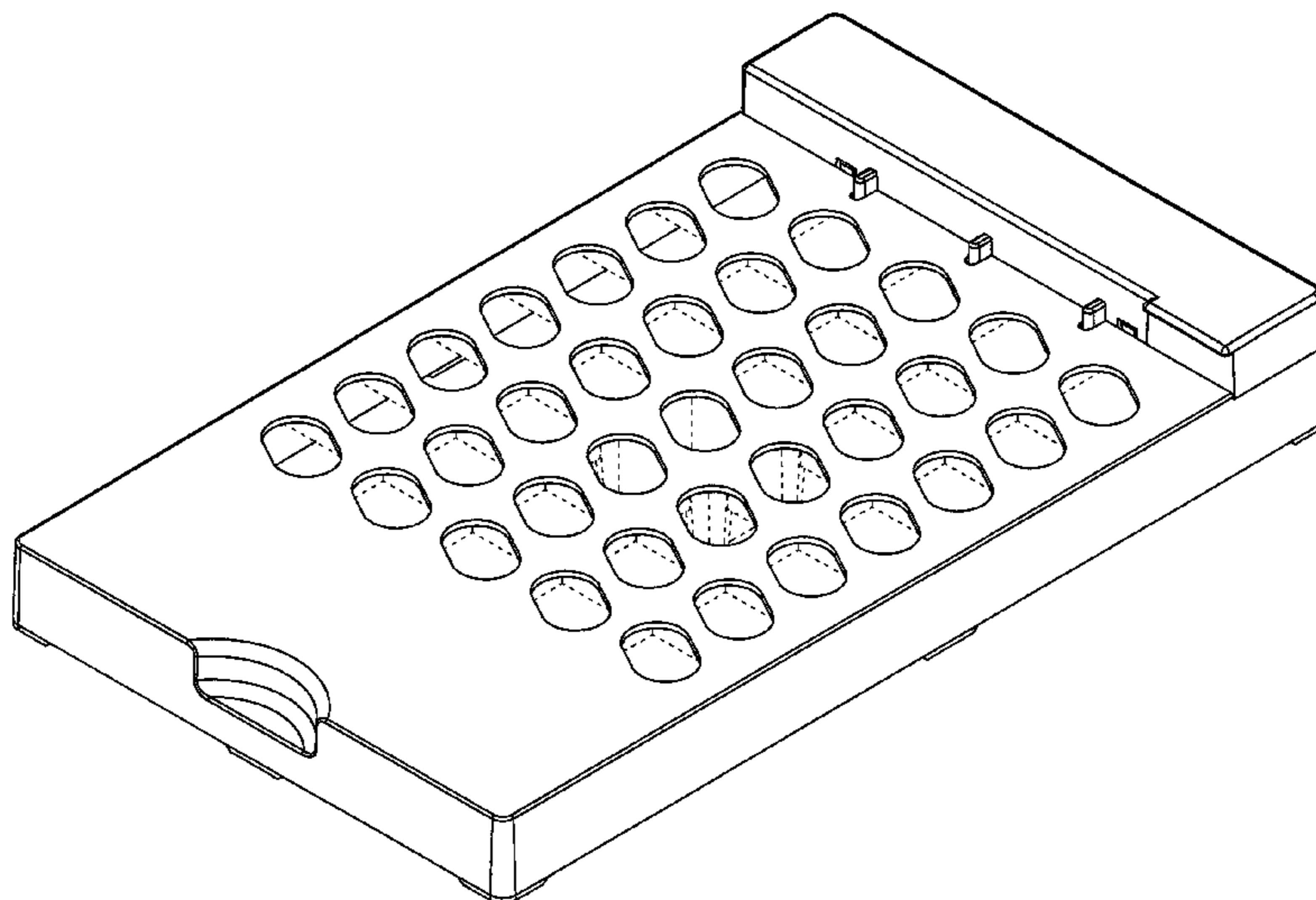

(56)

**References Cited**

U.S. PATENT DOCUMENTS

D518,737 S \* 4/2006 Zalzal ..... D9/732  
 7,150,355 B2 \* 12/2006 Coe et al. .... 206/536  
 D543,120 S \* 5/2007 Coe et al. .... D9/732  
 D546,198 S 7/2007 Currie et al.  
 D558,603 S 1/2008 Priebe et al.  
 D562,153 S \* 2/2008 Ruble et al. .... D9/732  
 7,588,149 B2 \* 9/2009 Gelardi ..... 206/531  
 D622,158 S 8/2010 Proulx  
 D637,391 S 5/2011 Stevens et al.  
 7,938,265 B2 \* 5/2011 Bitner ..... 206/536  
 7,967,144 B2 \* 6/2011 Sack et al. .... 206/538  
 D645,244 S \* 9/2011 Rietjens et al. .... D3/203.3  
 8,047,372 B2 \* 11/2011 Leifeld ..... 206/534  
 D650,295 S 12/2011 Schmitz et al.  
 D658,990 S 5/2012 Specker et al.  
 D658,991 S 5/2012 Schmitz et al.  
 D659,019 S 5/2012 Specker et al.  
 D659,022 S 5/2012 Kemner

8,220,636 B2 \* 7/2012 Beecroft et al. .... 206/535  
 2006/0086638 A1 4/2006 Priebe et al.  
 2006/0086639 A1 4/2006 Priebe et al.

OTHER PUBLICATIONS

Exhibit B Pill Dispenser Identification Labels. Product publicly available prior to Feb. 25, 2005.  
 Exhibit C Mocorp Inc. Redi Pak™ Pill Dispenser Identification Card. Product publicly available prior to Feb. 25, 2005.  
 Exhibits D1-D3 Apothecary Products, Inc. EZY Dose Memory Pack™ System Pill Dispenser Sealing Tray, Item #97550K3. Product publicly available prior to Feb. 25, 2005.  
 Exhibits E1-E6 Apothecary Products, Inc. EZY Dose Memory Pack™ System Pill Dispenser Sealing Tray Prototype (Red). Product publicly available prior to Feb. 25, 2005.  
 Exhibits F1-F5 Apothecary Products, Inc. EZY Dose Memory Pack™ System Pill Dispenser Sealing Tray Prototype (Black). Product publicly available prior to Feb. 25, 2005.

\* cited by examiner

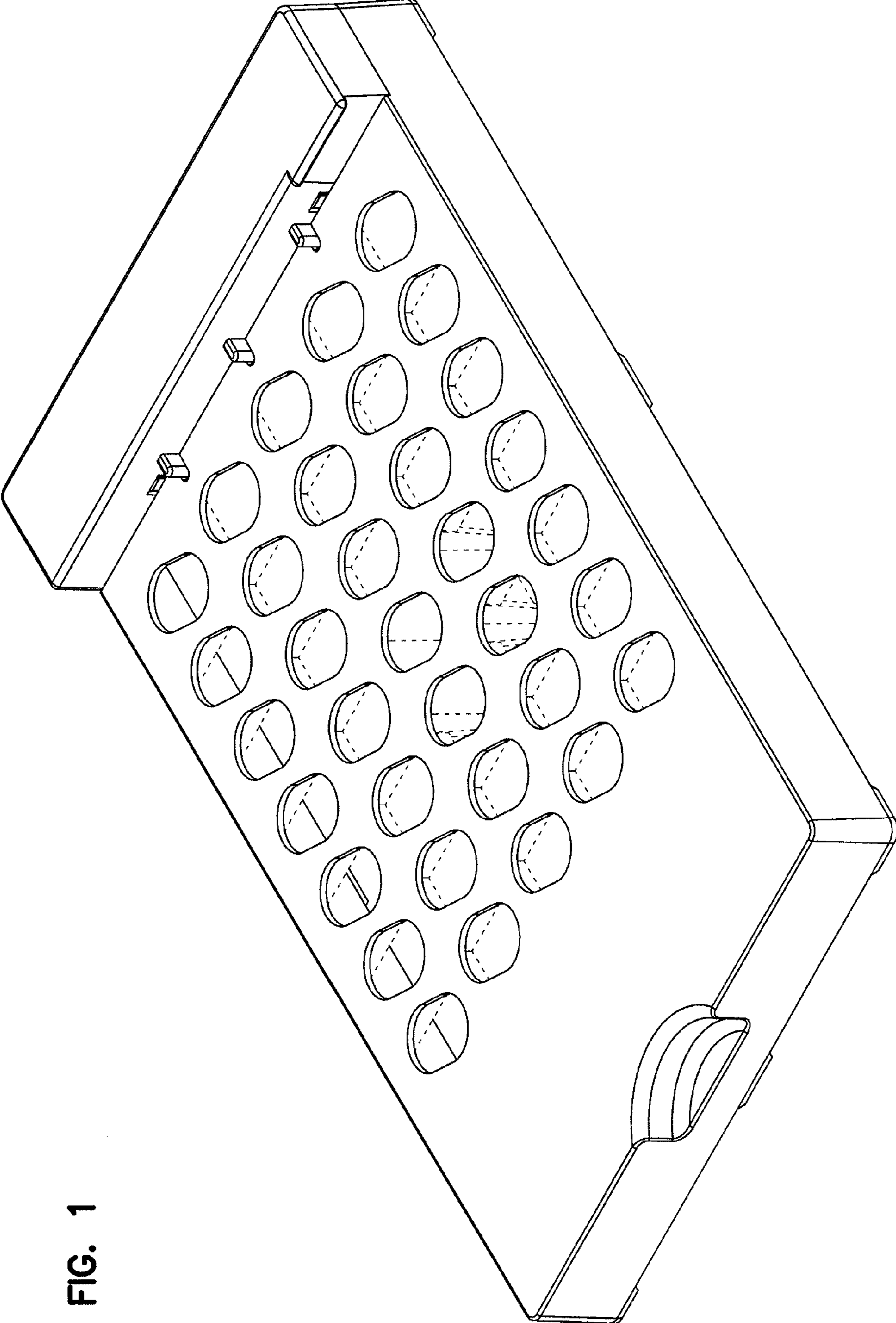

FIG. 1



FIG. 2

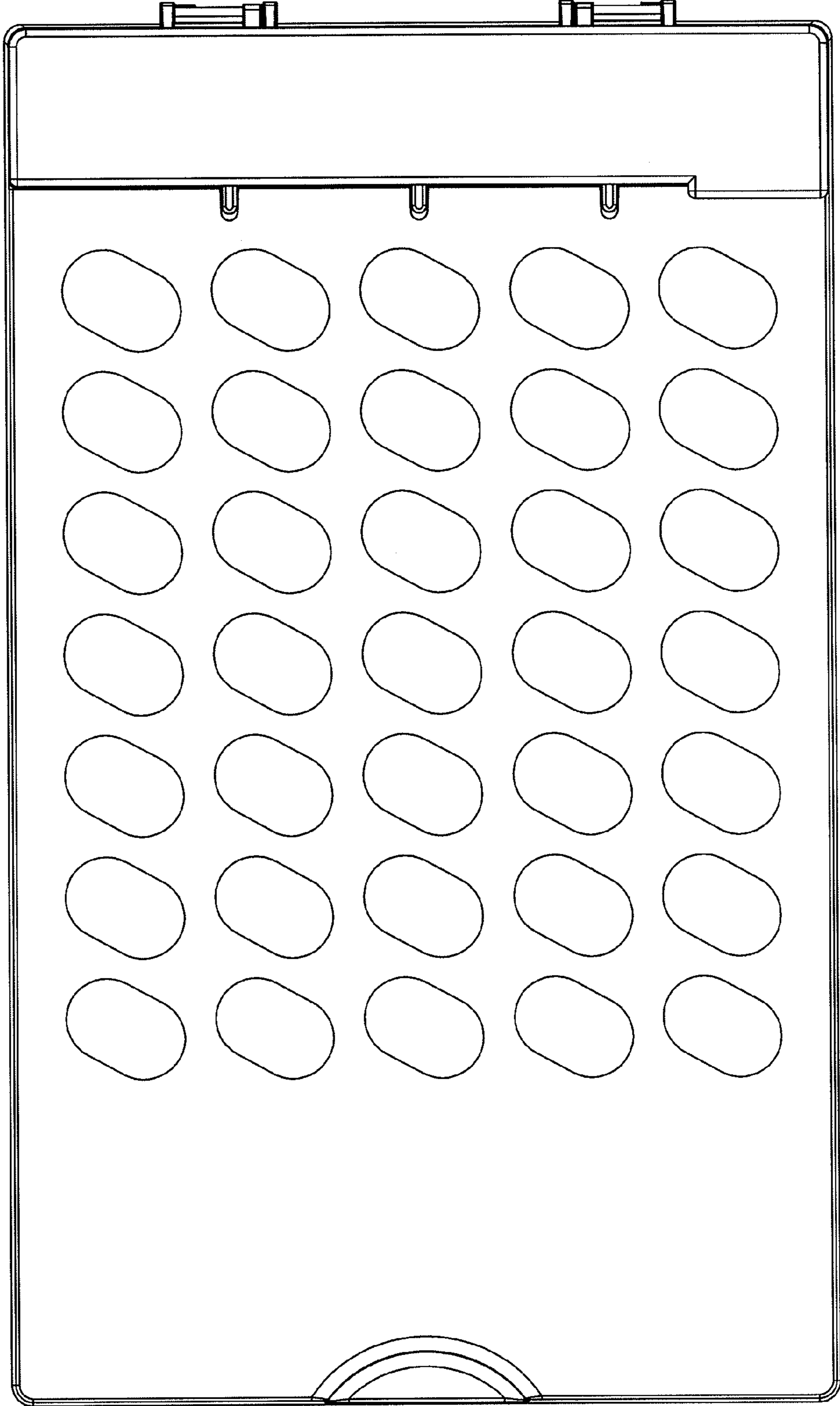

FIG. 3

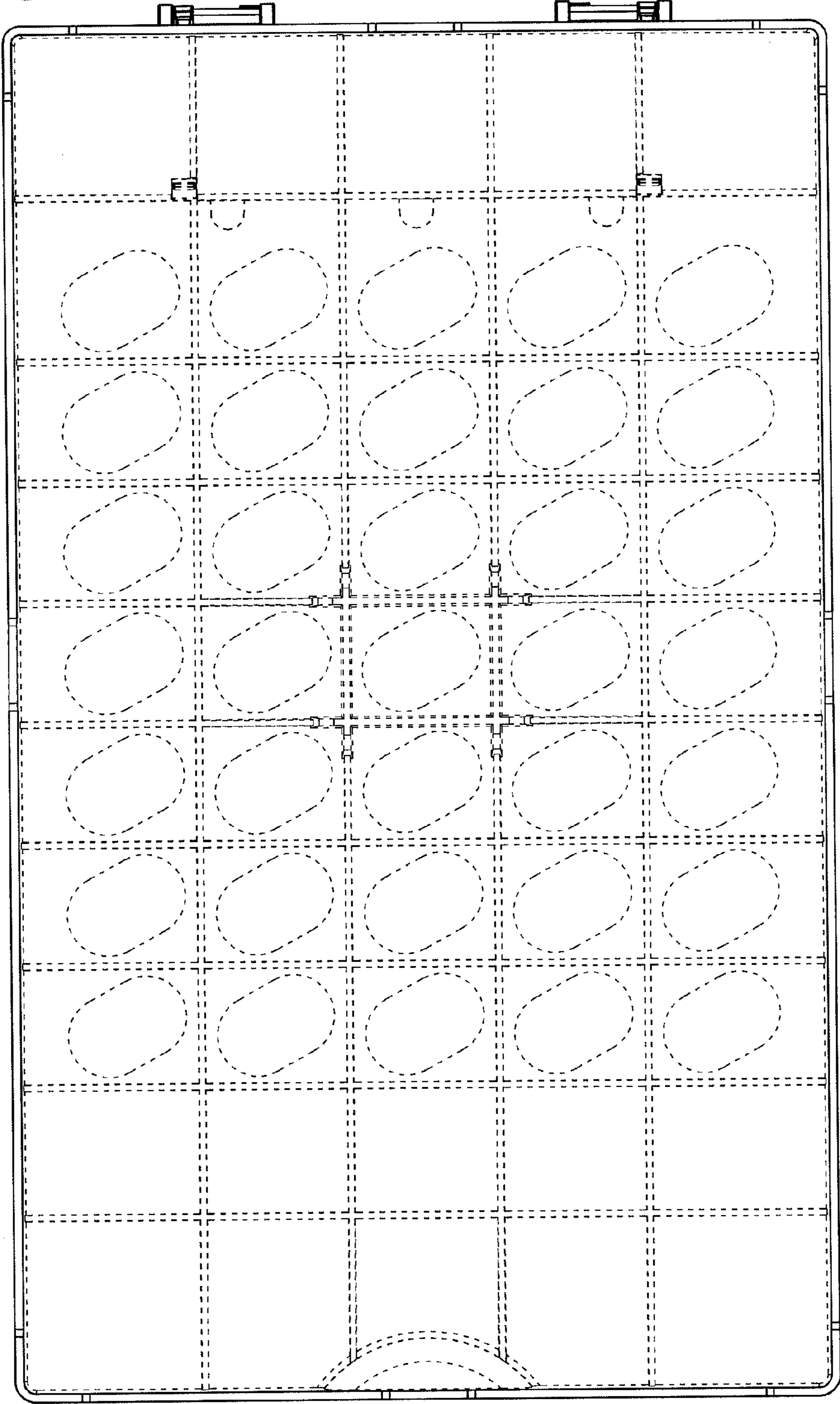

FIG. 4

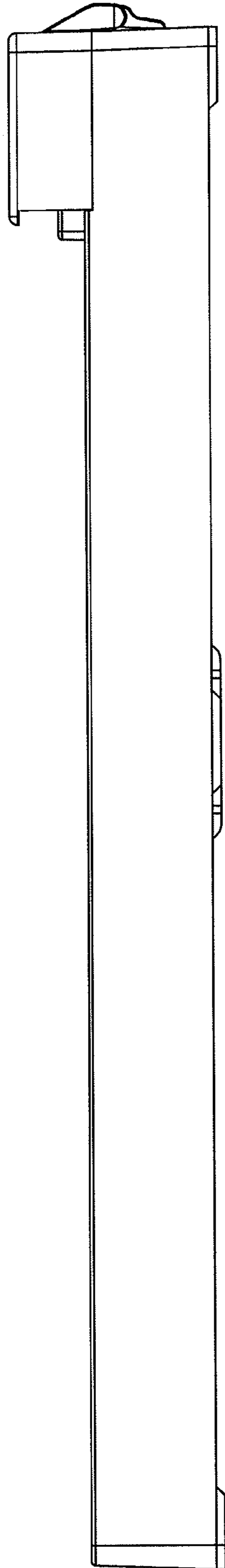

FIG. 5

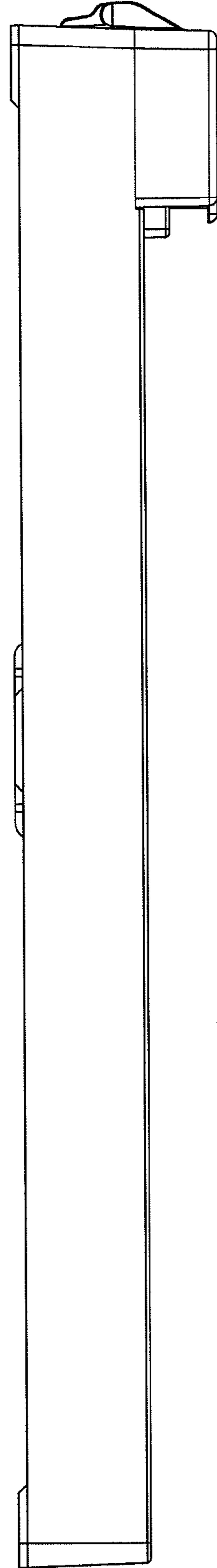

FIG. 6

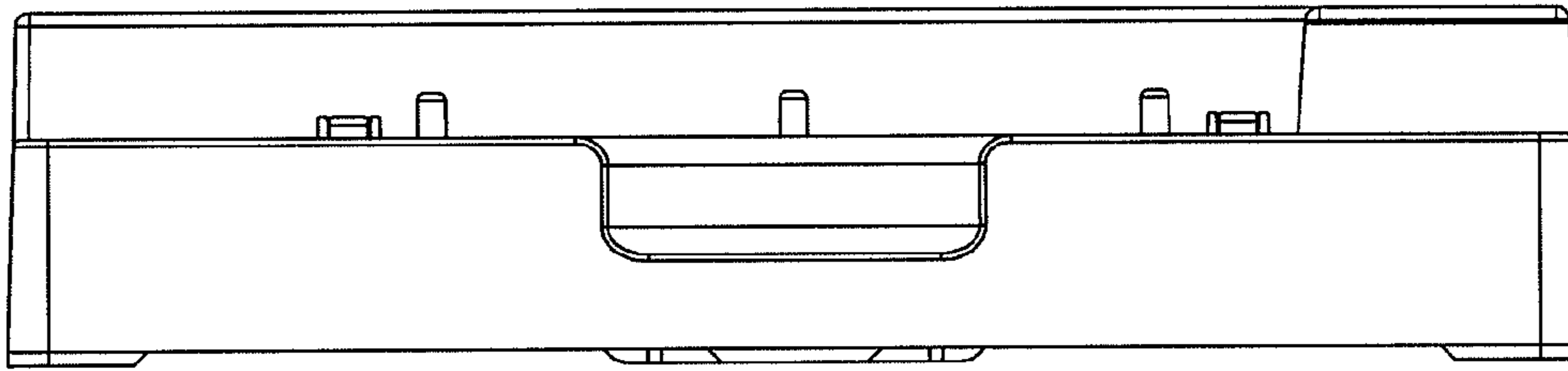

FIG. 7

