



US00D694715S

(12) **United States Design Patent**
Fichte et al.

(10) **Patent No.:** **US D694,715 S**
(45) **Date of Patent:** **** Dec. 3, 2013**

(54) **CONTROL UNIT**

(75) Inventors: **Daniel Fichte**, Dippoldiswalde (DE);
Thorsten Helm, Sassenberg (DE)

(73) Assignee: **Dewertokin GmbH**, Kirchlingern (DE)

(**) Term: **14 Years**

(21) Appl. No.: **29/407,140**

(22) Filed: **Nov. 23, 2011**

(30) **Foreign Application Priority Data**

May 24, 2011 (EM) 001868076-0001

(51) **LOC (9) Cl.** **13-03**

(52) **U.S. Cl.**
USPC **D13/162**

(58) **Field of Classification Search**
USPC D13/162, 164, 168, 171; D6/716.7;
307/139; 361/679.01, 679.11, 679.22;
200/5 R, 5 A, 61.7, 520, 530, 293, 296,
200/331

See application file for complete search history.

(56) **References Cited**

U.S. PATENT DOCUMENTS

D552,039 S * 10/2007 Liao D13/162
D557,946 S * 12/2007 Matern et al. D6/500
D565,923 S * 4/2008 Hoshimoto D8/302
7,506,560 B2 * 3/2009 Klinke 74/411.5
7,538,284 B2 * 5/2009 Nielsen et al. 200/296
D626,093 S * 10/2010 Bates D13/174
D652,390 S * 1/2012 Boehm et al. D13/158
D678,217 S * 3/2013 Helm D13/162

OTHER PUBLICATIONS

Logicdata, <http://www.logicdata.at/CONTROL-UNITS.14.0.html>,
printed on Feb. 16, 2012.

Logicdata, User Manual Control Unit for an Electric Height-Adjustable Desk Compact for firmware version 1.7.6 or higher Rev 3, 2011, pp. 1-43.
Logicdata, User Manual Control Unit for an Electric Height-Adjustable Desk LogicS-2/LogicS-3 Rev 6, 2009, pp. 1-36.
Logicdata, User Manual Control Unit for an Electric Height-Adjustable Desk LogicB-5/LogicB-4 Rev 2, 2009, pp. 1-33.
Logicdata, Datasheet Control Unit for an Electric Height-Adjustable Desk Compact Rev 3, 2011, pp. 1-11.
Logicdata, Datasheet Control Unit for an Electric Height-Adjustable Desk LogicB-5/LogicB-4 Rev 4, 2011, pp. 1-9.
Logicdata, Datasheet Control Unit for an Electric Height-Adjustable Desk LogicS-2-xxx-US/LogicS-3-xxx-US Rev 7, 2011, pp. 1-10.

(Continued)

Primary Examiner — Selina Sikder

(74) *Attorney, Agent, or Firm* — Cahn & Samuels, LLP

(57) **CLAIM**

We claim the ornamental design for a control unit, as shown and described.

DESCRIPTION

FIG. 1 illustrates a top view of a control unit according to the invention.

FIG. 2 illustrates a bottom view of the control unit illustrated in FIG. 1.

FIG. 3 illustrates a perspective view of the control unit illustrated in FIG. 1.

FIG. 4 illustrates a first side view of the control unit illustrated in FIG. 1.

FIG. 5 illustrates a first end view of the control unit illustrated in FIG. 1.

FIG. 6 illustrates a second end view of the control unit illustrated in FIG. 1; and,

FIG. 7 illustrates a second side view of the control unit illustrated in FIG. 1.

The broken line illustrations in the Figures are environmental structure and are not part of the design sought to be claimed.

1 Claim, 3 Drawing Sheets

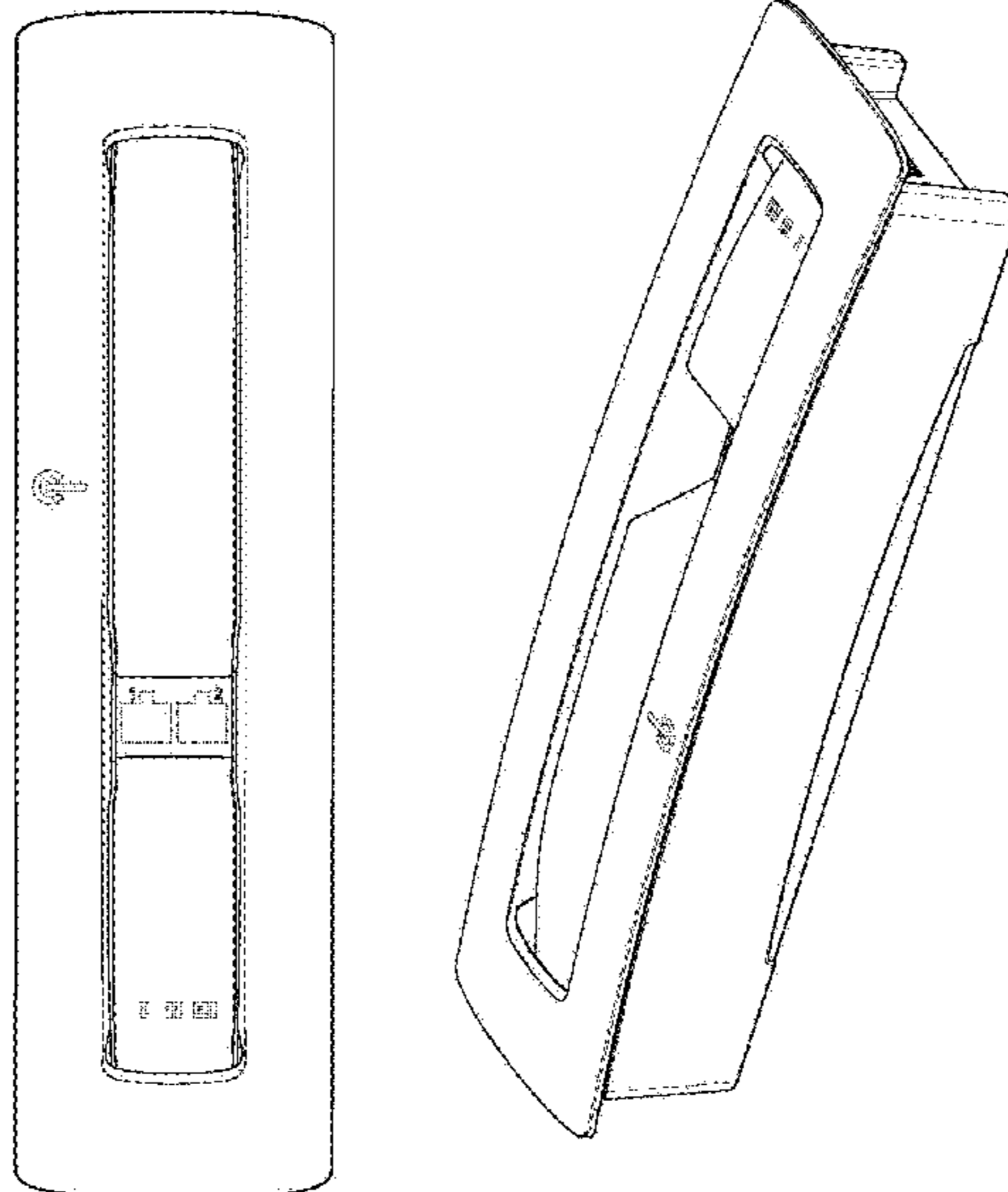

(56)

References Cited

OTHER PUBLICATIONS

Logicdata, Datasheet Control Unit for an Electric Height-Adjustable Desk LogicS-2/LogicS-3 Rev 7, 2011, pp. 1-10.

Linak, Control Box CBD4, Sep. 2010, <http://www.linak.com/products/Control-Boxes.aspx?product=CBD4>, printed on Feb. 16, 2012.

Linak, Control Box CBD5, Nov. 2011, <http://www.linak.com/products/Control-Boxes.aspx?product=CBD5>, printed on Feb. 16, 2012.

Linak, Control Box CBD6, Nov. 2011, <http://www.linak.com/products/Control-Boxes.aspx?product=CBD6>, printed on Feb. 16, 2012.

Linak, Product Data Sheet CBD4 Control Box, Sep. 2010, pp. 1-4.

Linak, Product Data Sheet CBD5 Control Box, Nov. 2011, pp. 1-4.

Linak, Product Data Sheet CBD6 Zero Control Box, Nov. 2011, pp. 1-4.

* cited by examiner

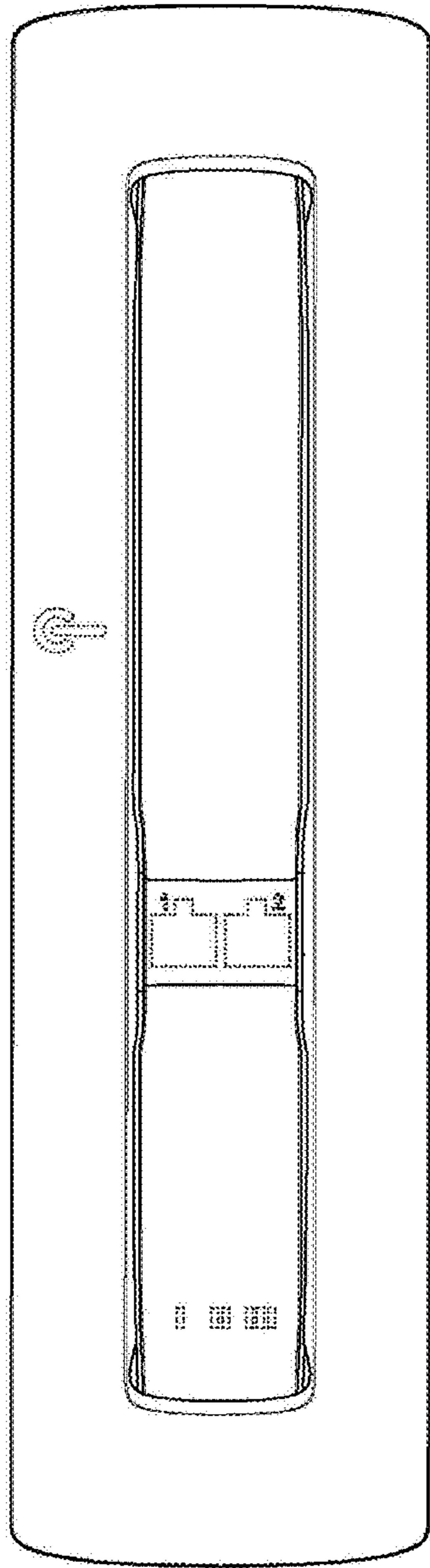

FIG. 1

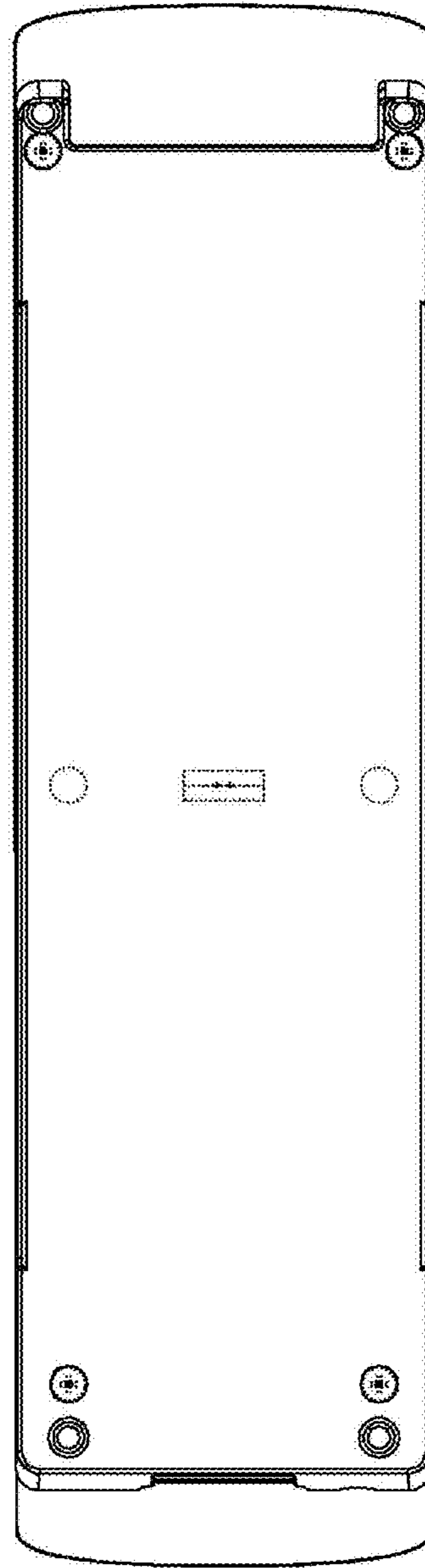

FIG. 2

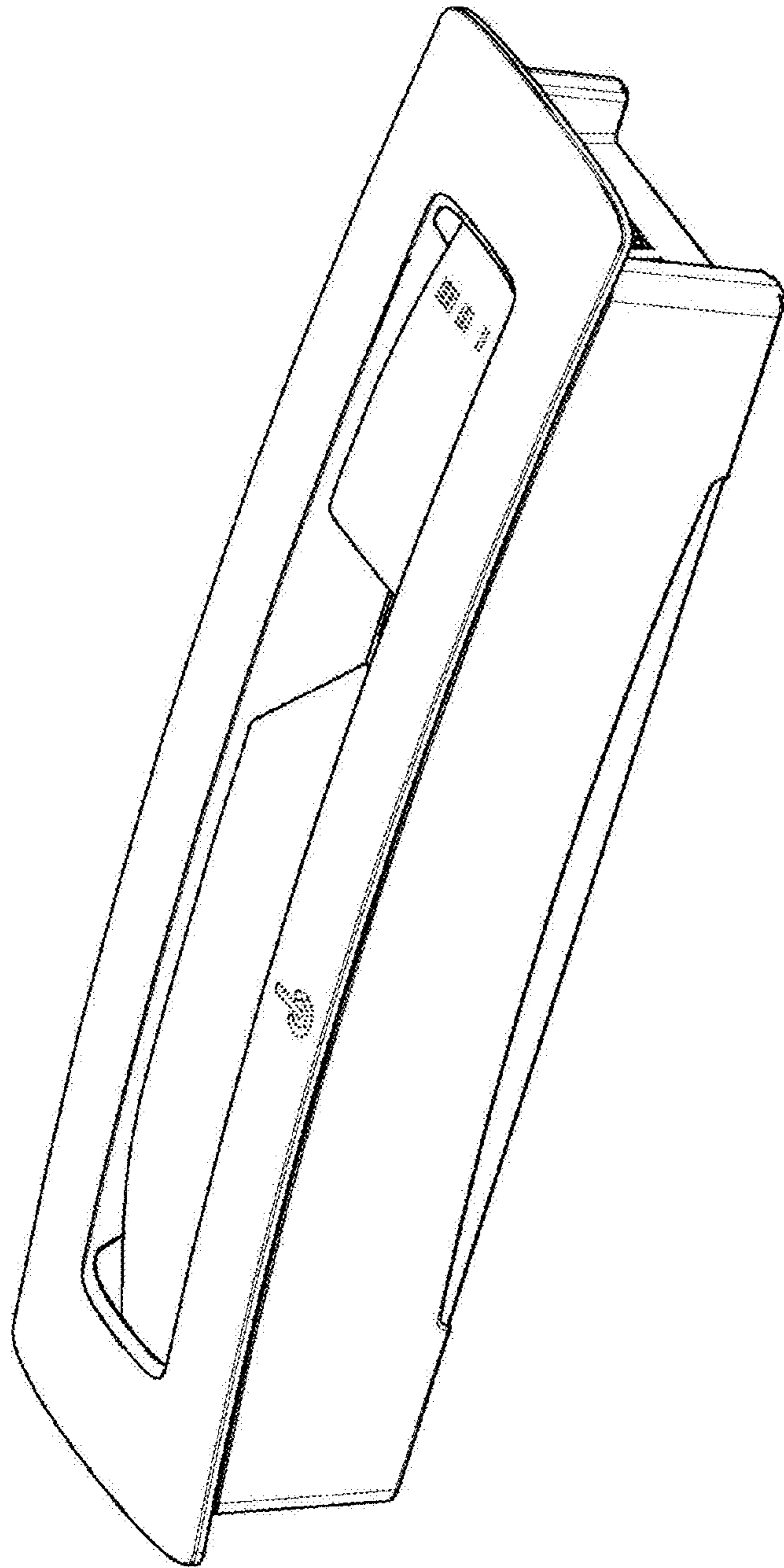

FIG. 3

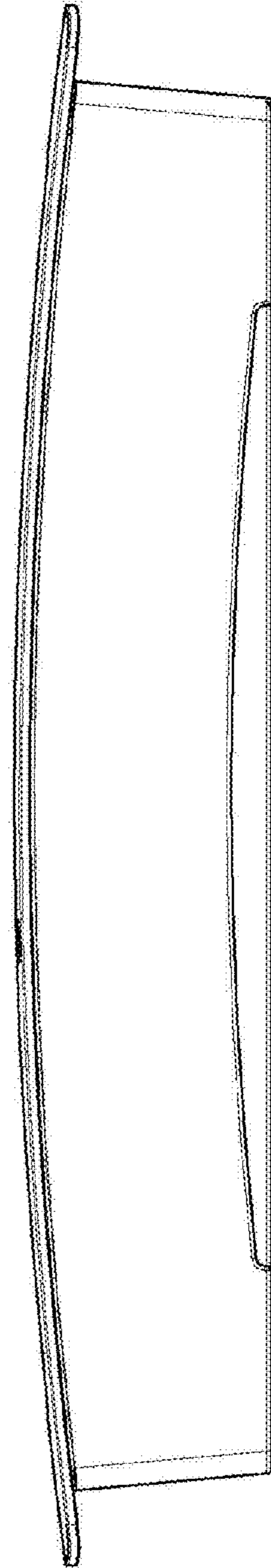

FIG. 4

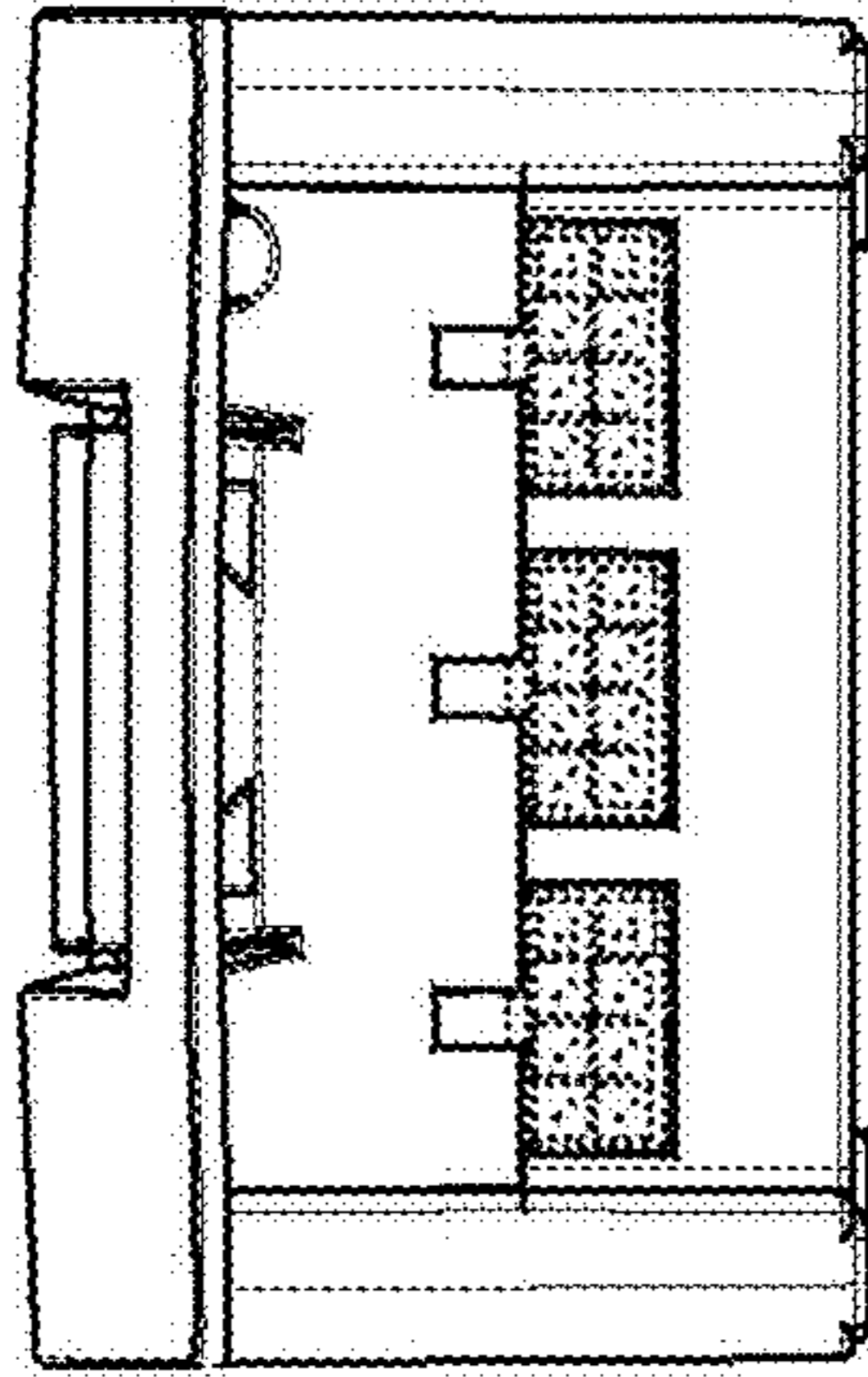

FIG. 5

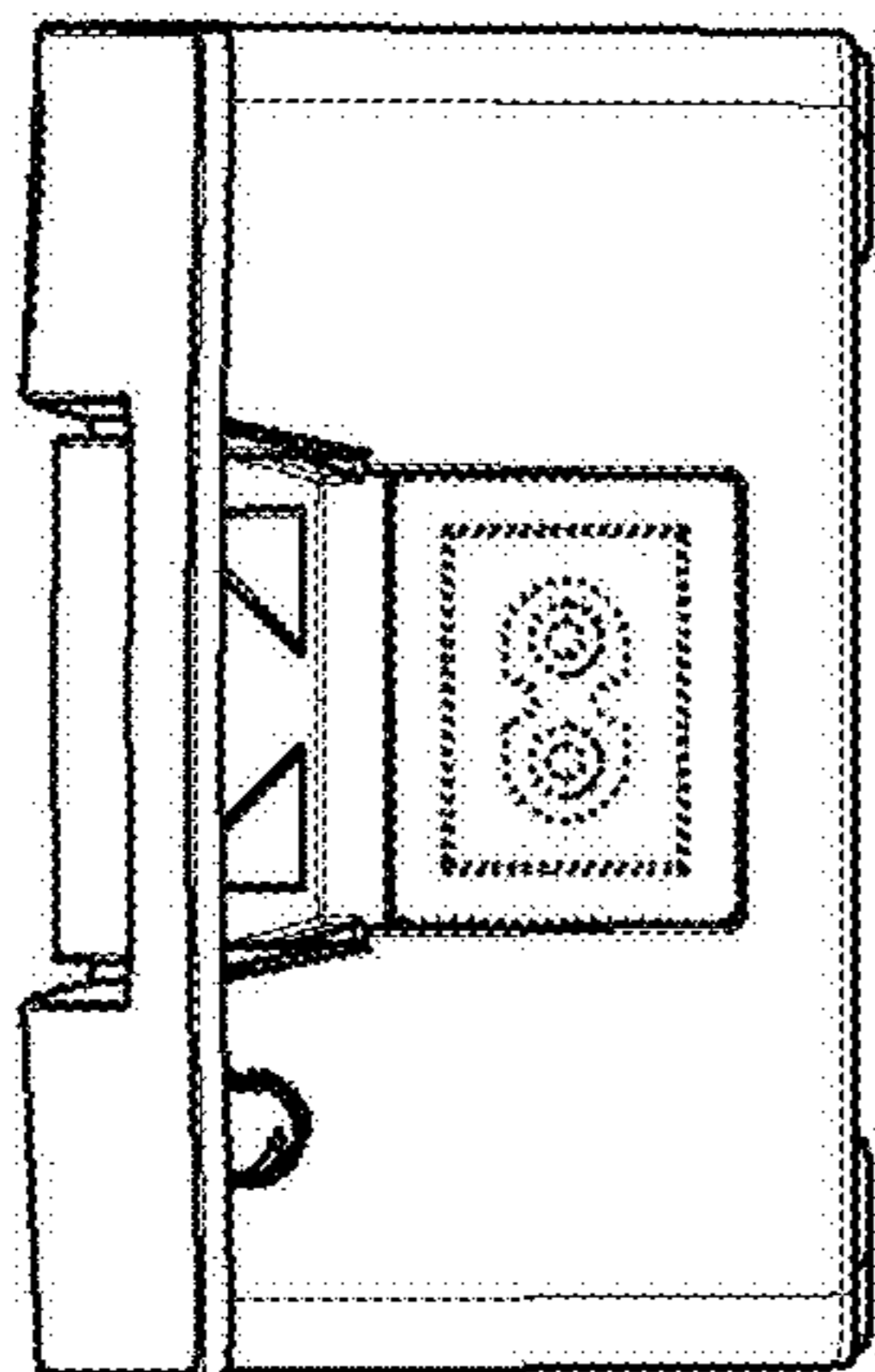

FIG. 6

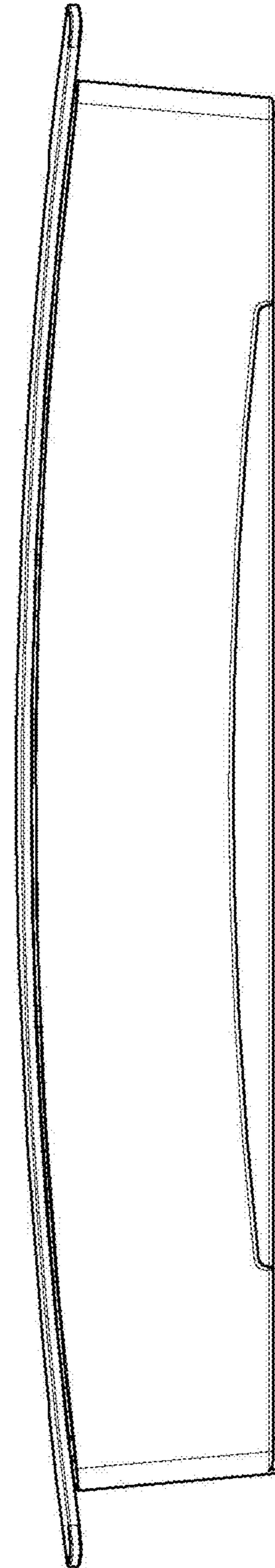

FIG. 7

UNITED STATES PATENT AND TRADEMARK OFFICE
CERTIFICATE OF CORRECTION

PATENT NO. : D694,715 S
APPLICATION NO. : 29/407140
DATED : December 3, 2013
INVENTOR(S) : Daniel Fichte and Thorsten Helm

Page 1 of 1

It is certified that error appears in the above-identified patent and that said Letters Patent is hereby corrected as shown below:

On the Title Page,

Item [73], Assignee, should read --**DewertOkin GmbH**--.

Signed and Sealed this
First Day of April, 2014



Michelle K. Lee
Deputy Director of the United States Patent and Trademark Office