



US00D694714S

(12) **United States Design Patent**
Bastida

(10) **Patent No.:** **US D694,714 S**

(45) **Date of Patent:** **** Dec. 3, 2013**

(54) **MULTIPLE TAP ELECTRICAL CONNECTOR**

(75) Inventor: **Edgar Bastida**, Toluca (MX)

(73) Assignee: **Hubbell Incorporated**, Shelton, CT (US)

(**) Term: **14 Years**

(21) Appl. No.: **29/426,709**

(22) Filed: **Jul. 10, 2012**

(51) **LOC (9) Cl.** **13-03**

(52) **U.S. Cl.**
USPC **D13/149**

(58) **Field of Classification Search**
USPC D13/133, 146, 147, 149, 151, 153, 154,
D13/184, 199; 439/409, 412, 417, 441, 709,
439/715, 716, 717; 361/823
See application file for complete search history.

(56) **References Cited**

U.S. PATENT DOCUMENTS

D152,135 S *	12/1948	Becker	D13/149
2,514,474 A *	7/1950	Cook	29/874
D214,273 S *	5/1969	Bricker, Jr.	D13/149
4,427,253 A	1/1984	Smith		
4,684,196 A	8/1987	Smith		
4,776,808 A	10/1988	Davidson		
5,041,012 A	8/1991	Caprio		
D329,224 S *	9/1992	Dinkel	D13/149
D361,750 S *	8/1995	Ansley	D13/151
5,636,306 A	6/1997	Mock		
7,104,832 B2	9/2006	Campbell		
7,485,014 B2	2/2009	De France		
D599,184 S *	9/2009	Johnson et al.	D8/72
8,025,521 B2	9/2011	Diniz		

D648,281 S *	11/2011	Cerasale	D13/151
D652,388 S *	1/2012	Cerasale	D13/151
D660,802 S *	5/2012	Quinn et al.	D13/151
2002/0177353 A1	11/2002	De France		

* cited by examiner

Primary Examiner — Thomas Johannes

(74) *Attorney, Agent, or Firm* — Marcus R. Mickney; Mark S. Bicks; Alfred N. Goodman

(57) **CLAIM**

The ornamental design for a multiple tap electrical connector, as shown and described.

DESCRIPTION

FIG. 1 is a front perspective view of a multiple tap electrical connector showing my new design in a usage condition with the claimed pressure set screws removed;
 FIG. 2 is a rear perspective view thereof;
 FIG. 3 is a front elevation view thereof;
 FIG. 4 is a rear elevation view thereof;
 FIG. 5 is a left side elevation view thereof;
 FIG. 6 is a right side elevation view thereof;
 FIG. 7 is a top plan view thereof;
 FIG. 8 is a bottom plan view thereof;
 FIG. 9 is a front perspective view thereof in a usage condition with the claimed pressure set screws connected thereto;
 FIG. 10 is a rear perspective view thereof;
 FIG. 11 is a front elevation view thereof;
 FIG. 12 is a rear elevation view thereof;
 FIG. 13 is a left side elevation view thereof;
 FIG. 14 is a right side elevation view thereof;
 FIG. 15 is a top plan view thereof; and,
 FIG. 16 is a bottom plan view thereof.

1 Claim, 10 Drawing Sheets

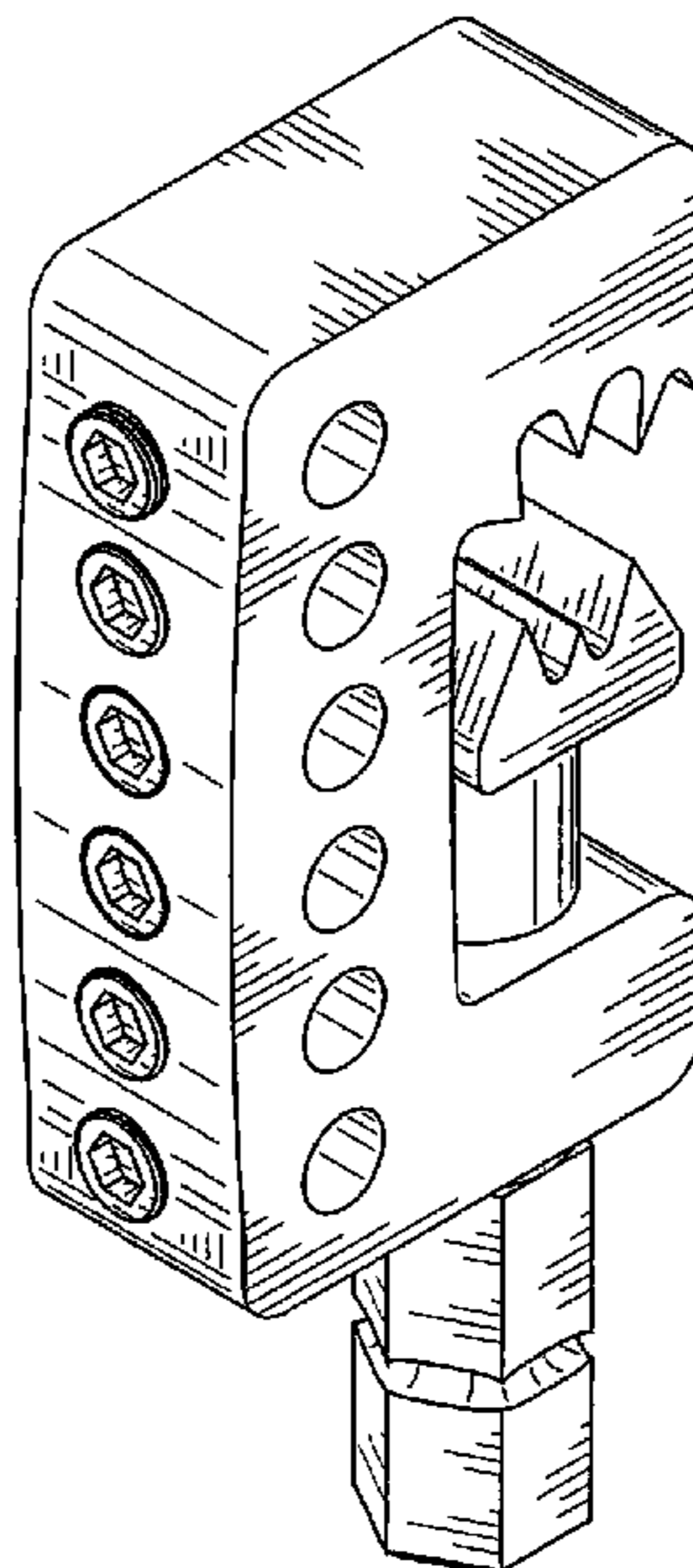
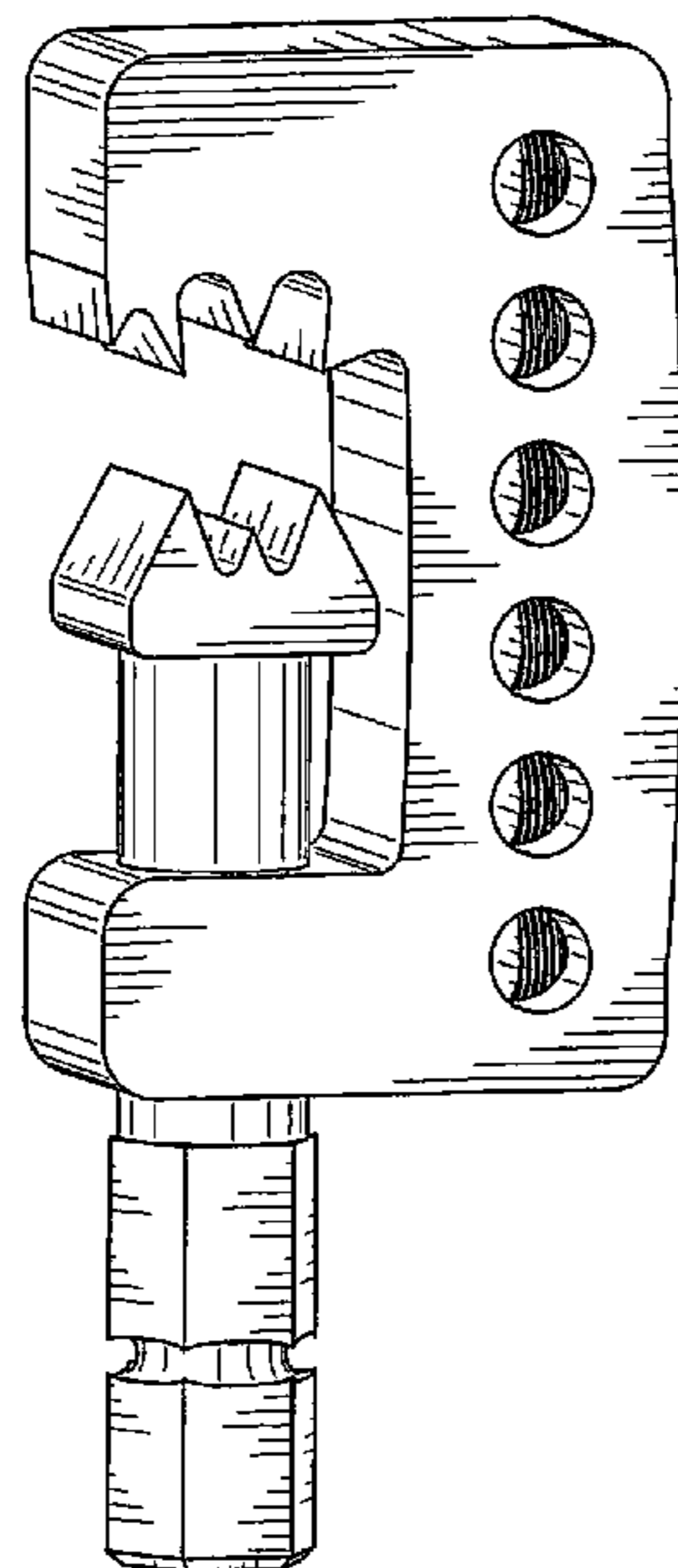

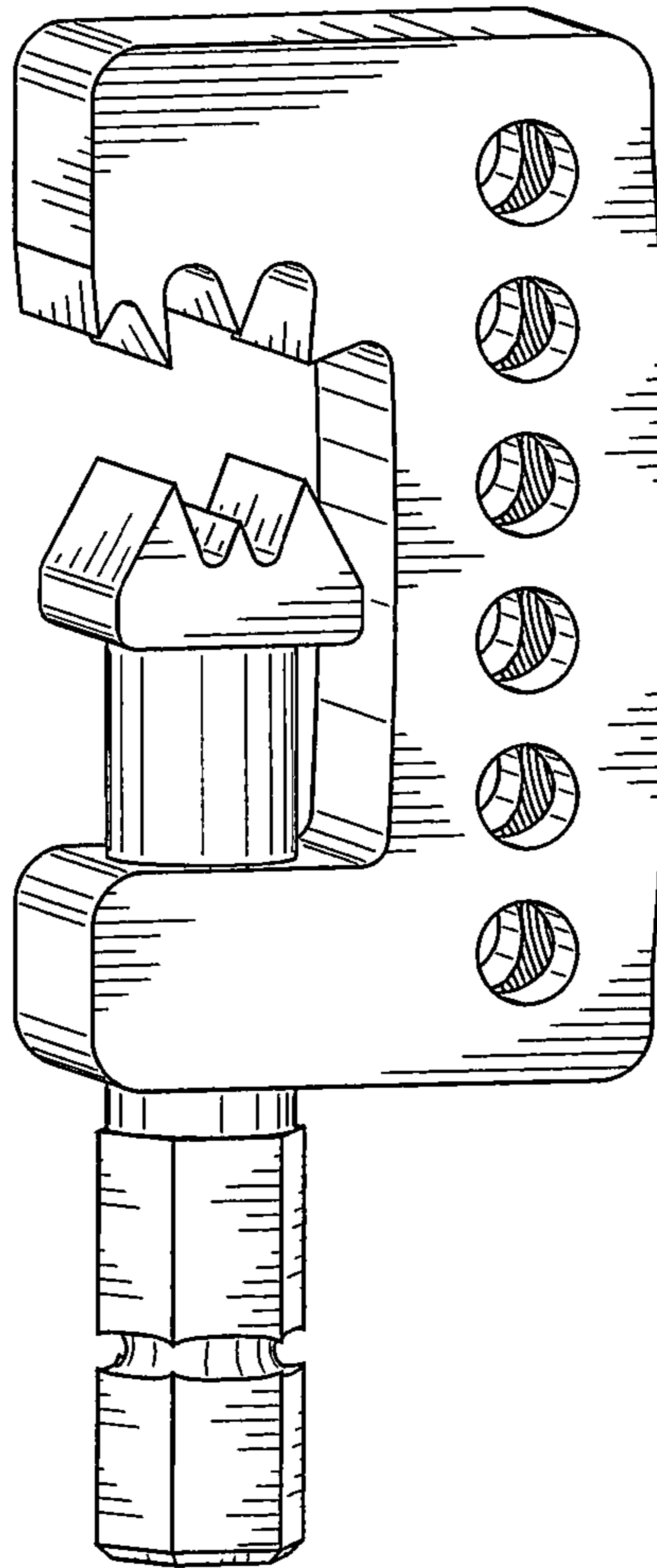

FIG. 1

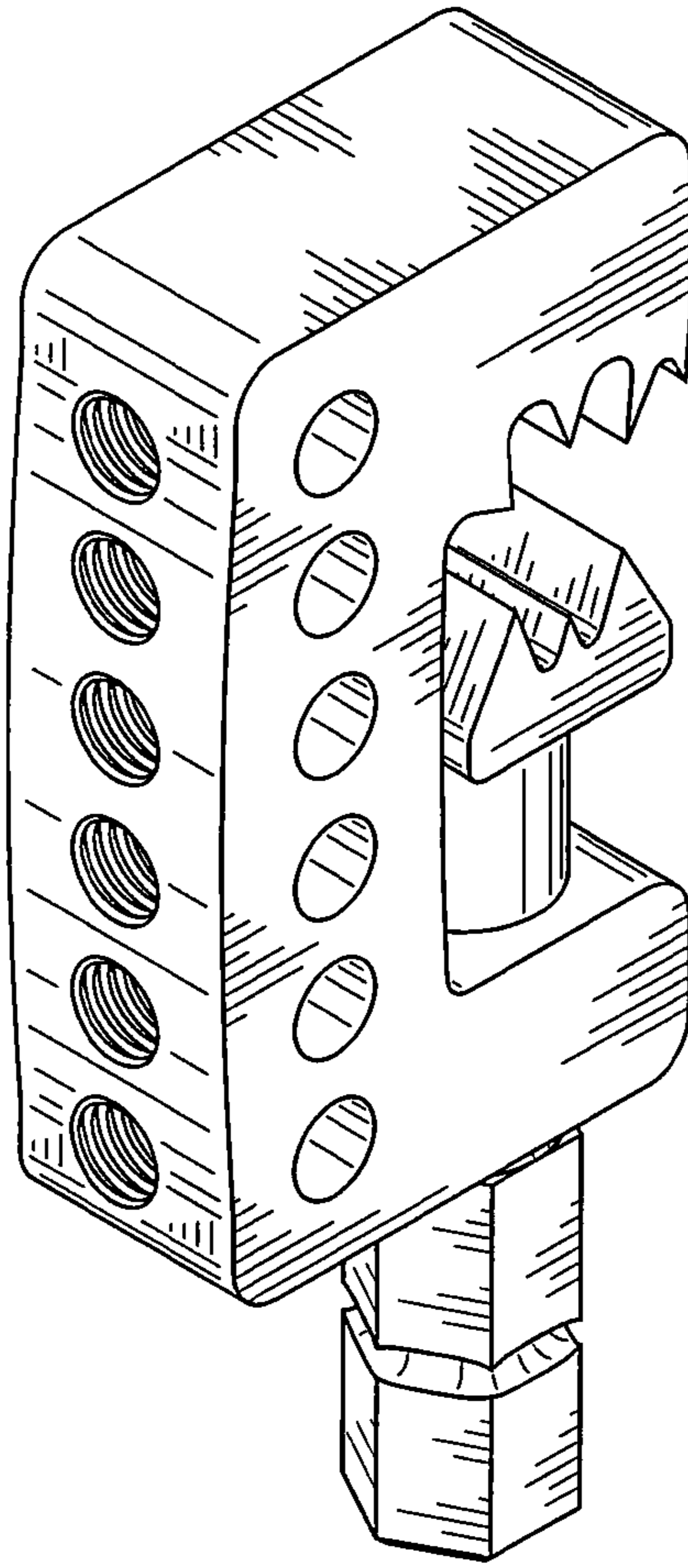

FIG. 2

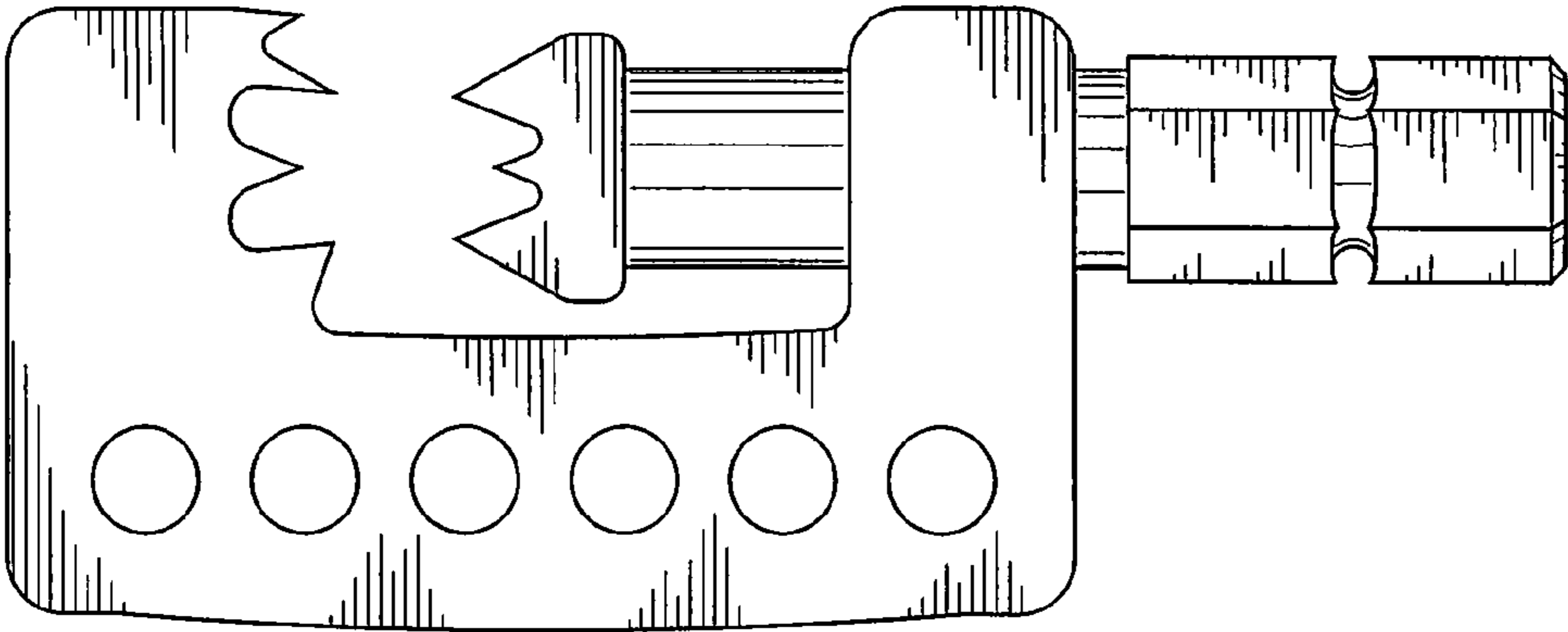

FIG. 4

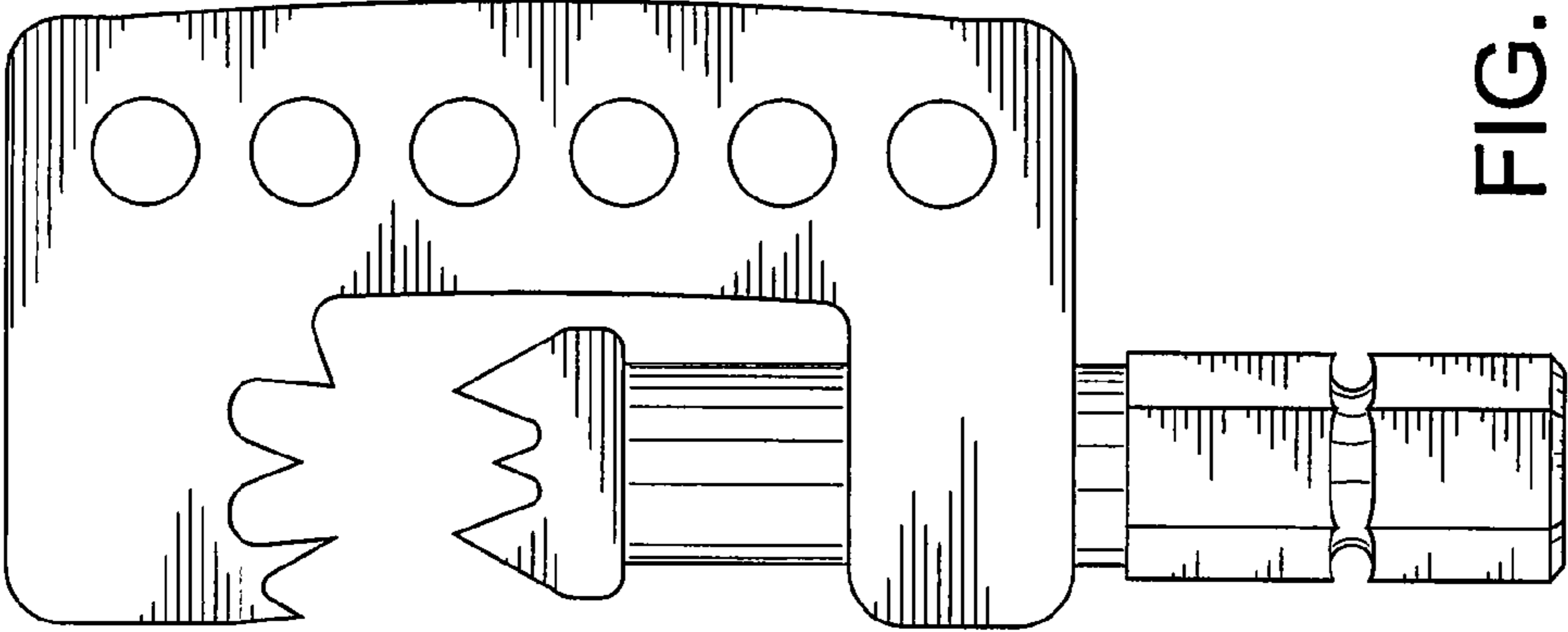

FIG. 3

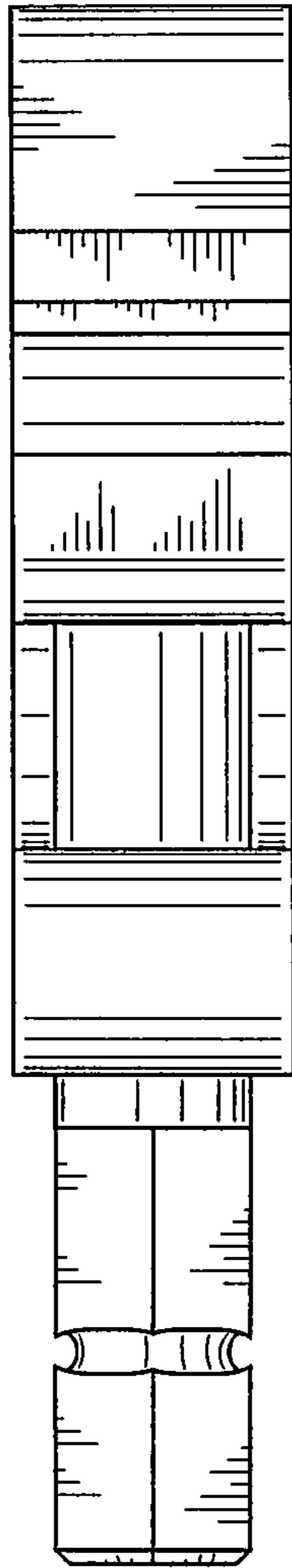

FIG. 5

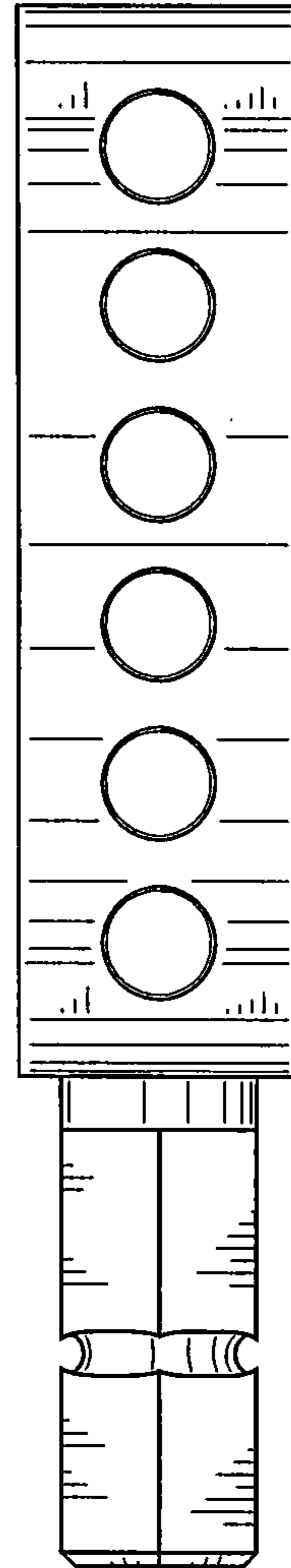

FIG. 6

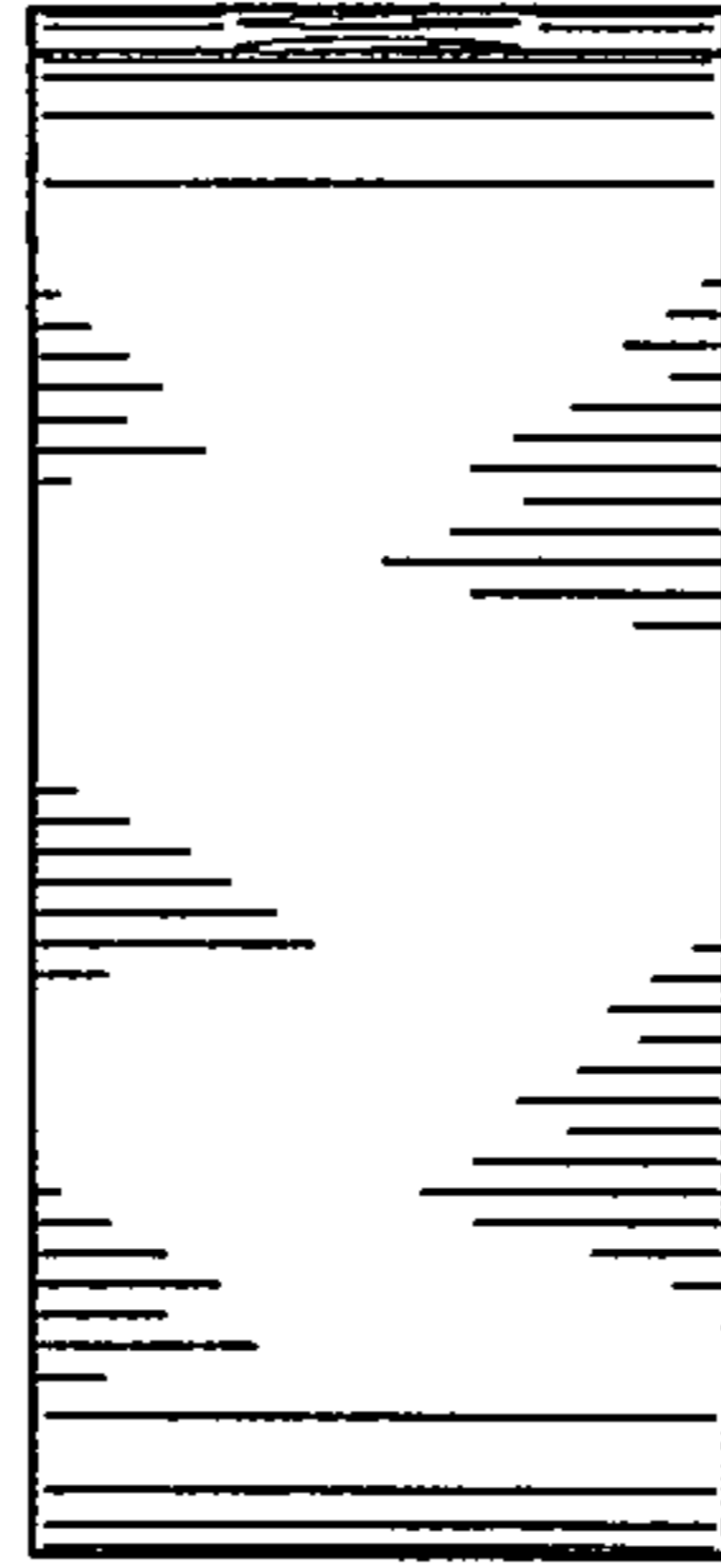

FIG. 7

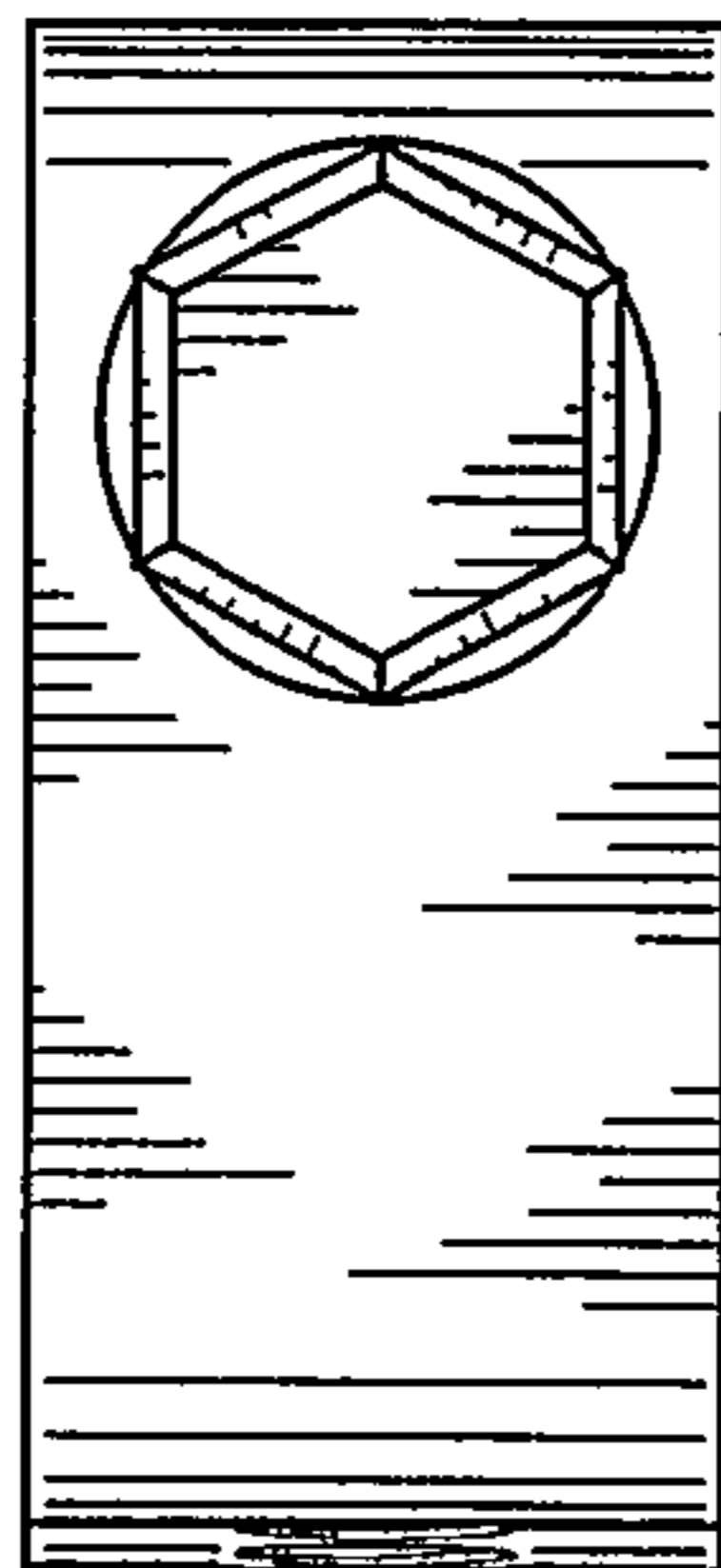

FIG. 8

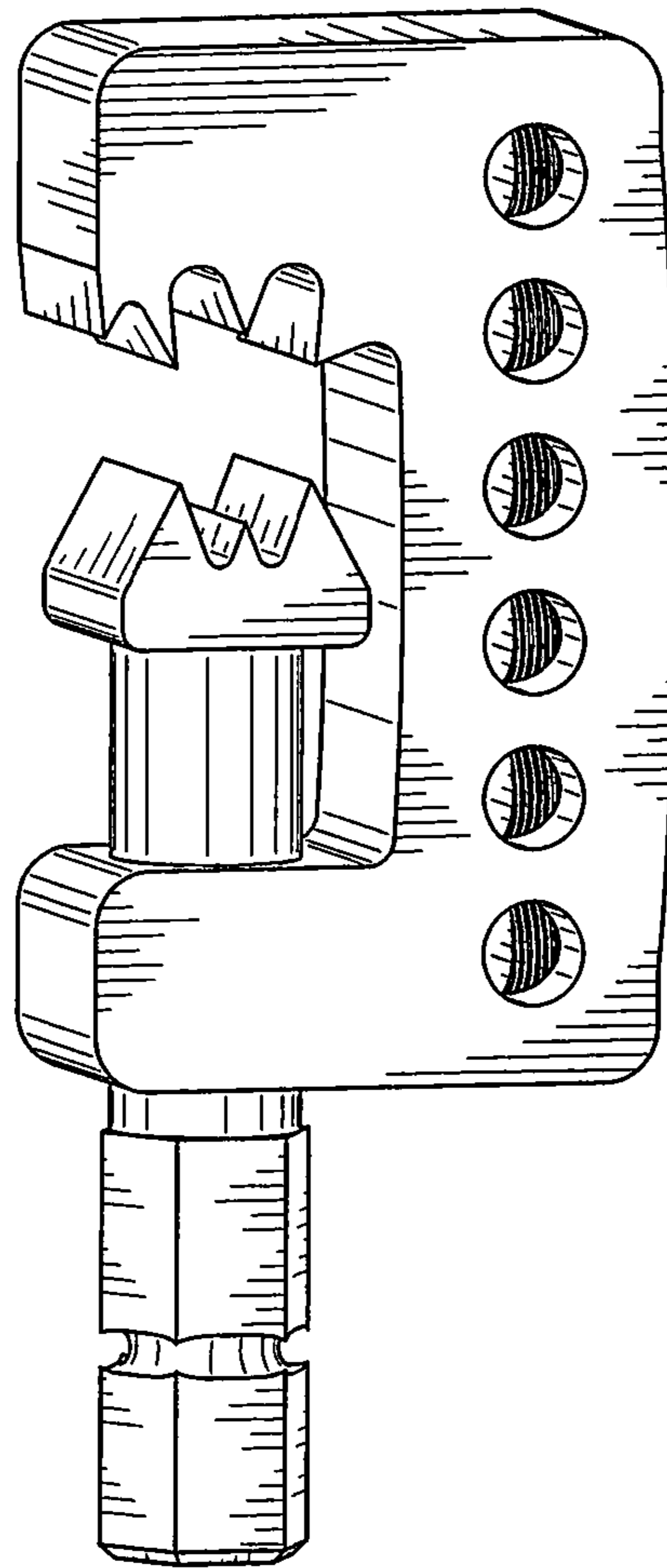

FIG. 9

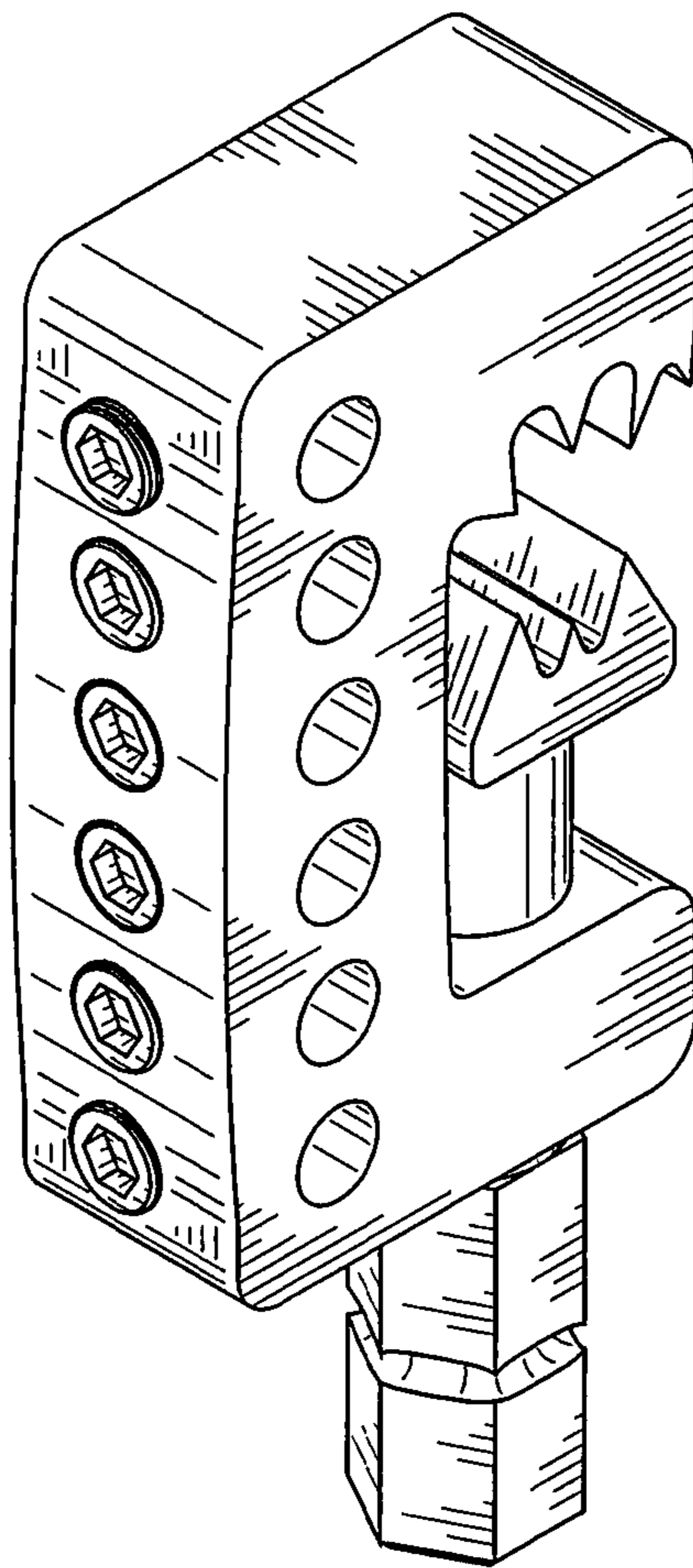

FIG. 10

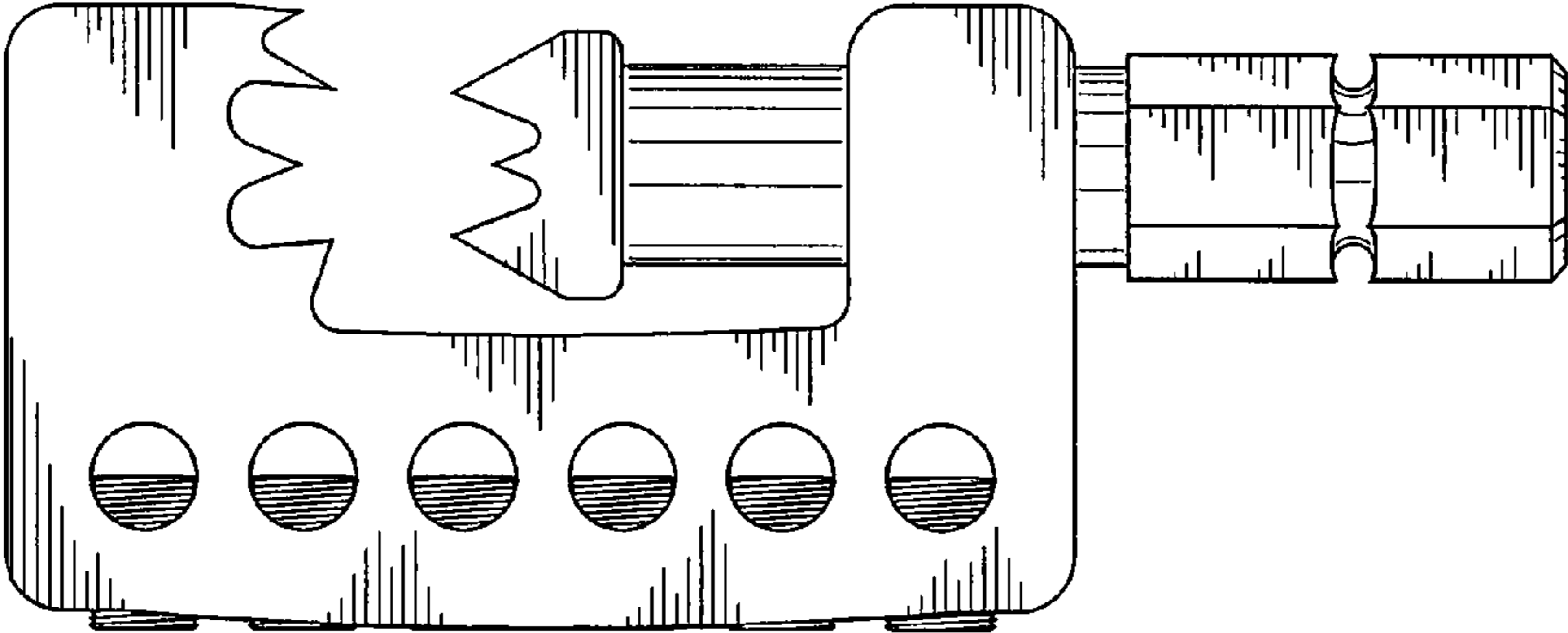

FIG. 12

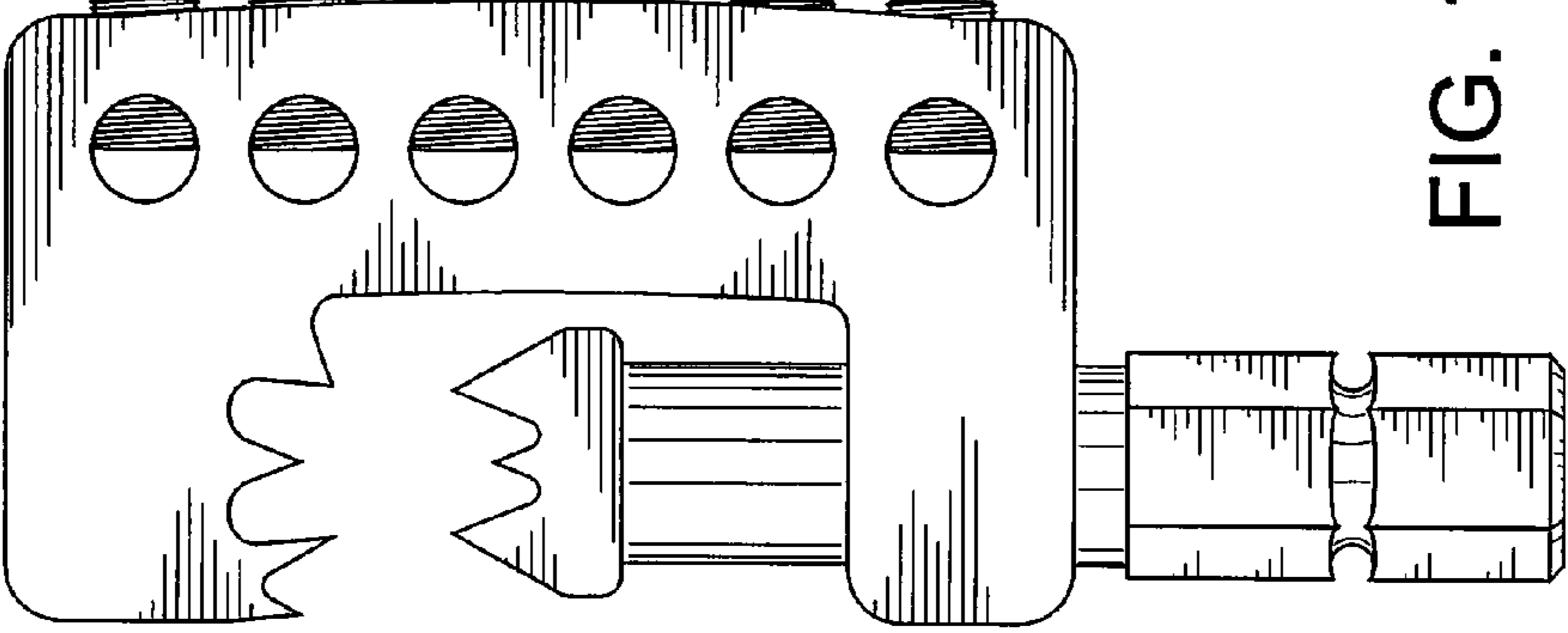

FIG. 11

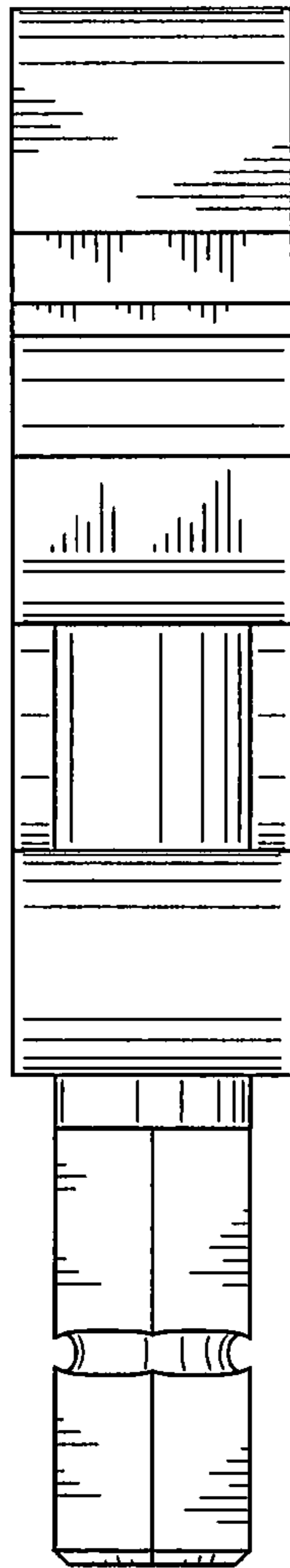

FIG. 13

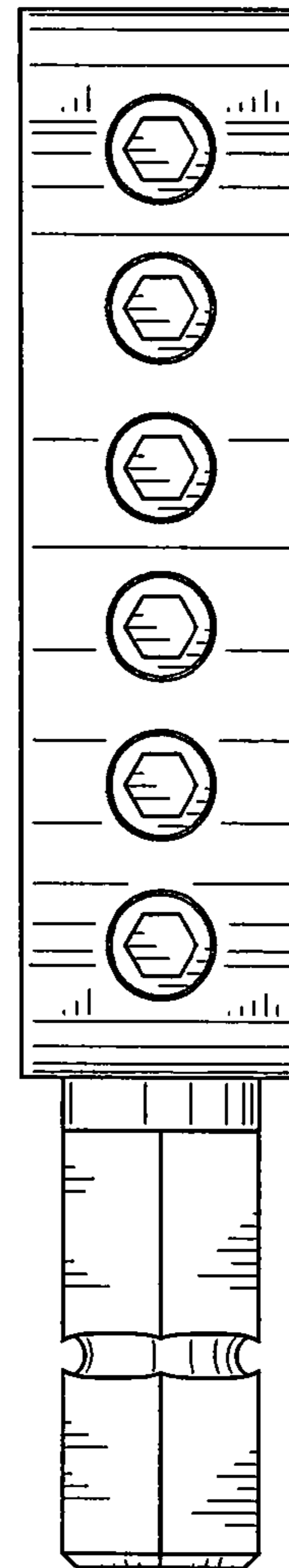

FIG. 14

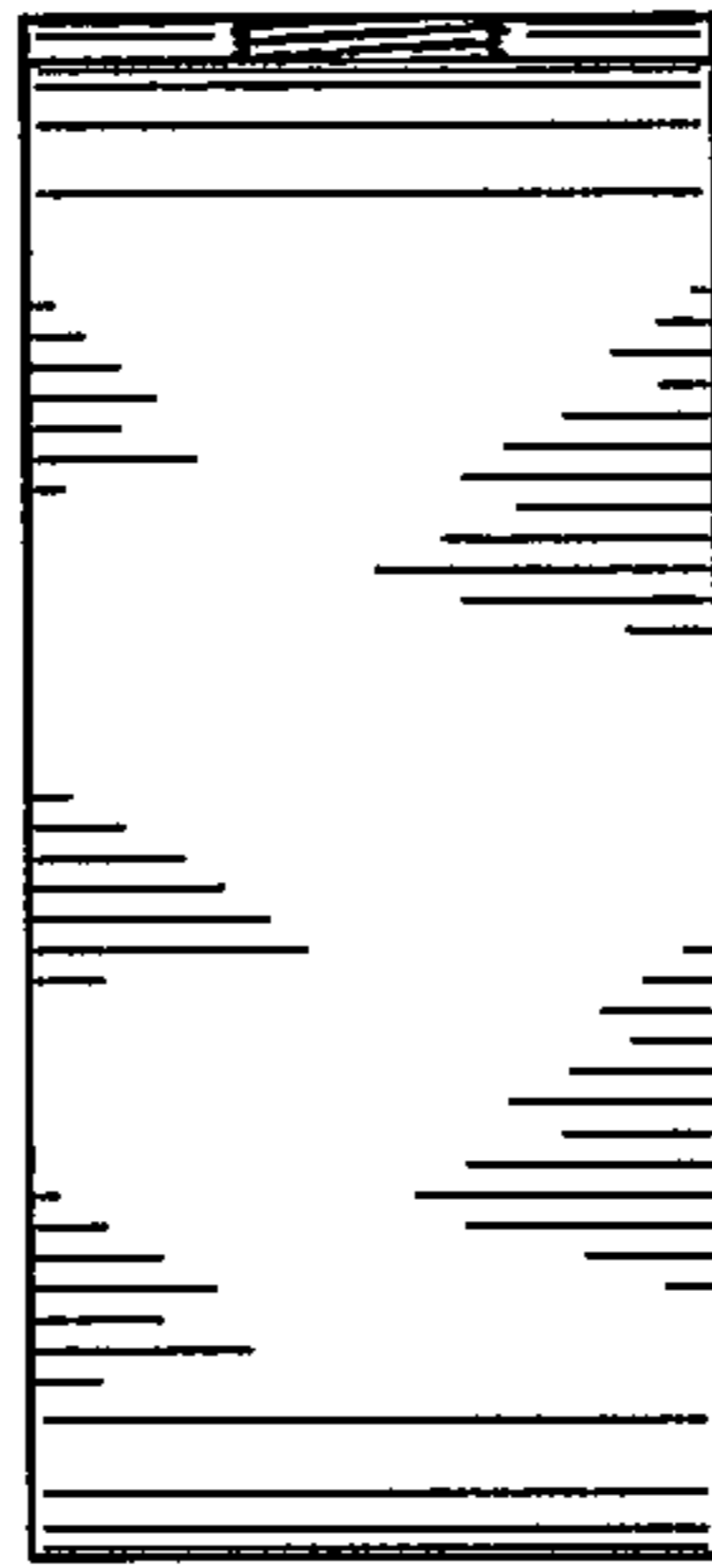

FIG. 15

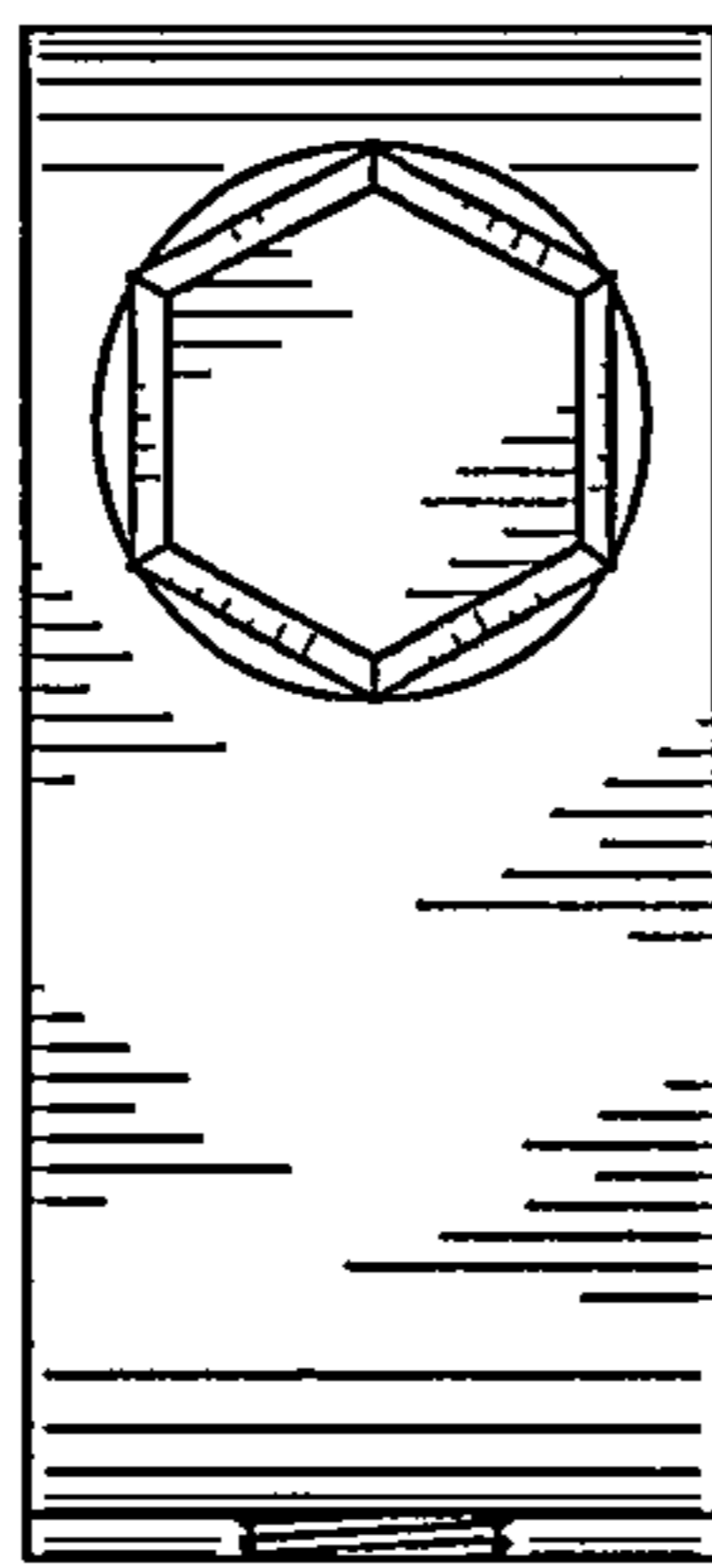

FIG. 16