



US00D694713S

(12) **United States Design Patent**
Yeo et al.

(10) **Patent No.:** **US D694,713 S**
(45) **Date of Patent:** **** Dec. 3, 2013**

(54) **POWER OUTLET**

(71) Applicant: **Dawon DNS Co., Ltd.**, Seoul (KR)

(72) Inventors: **Woon Nam Yeo**, Uiwang-si (KR); **Yong Yeon Park**, Bucheon-si (KR)

(73) Assignee: **Dawon D&S Co., Ltd.**, Seoul (KR)

(**) Term: **14 Years**

(21) Appl. No.: **29/441,953**

(22) Filed: **Jan. 11, 2013**

(30) **Foreign Application Priority Data**

Jul. 12, 2012 (KR) 30-2012-0033898

(51) **LOC (9) Cl.** **13-03**

(52) **U.S. Cl.**
USPC **D13/138.1**; D13/137.1

(58) **Field of Classification Search**
USPC D13/152, 137.1, 139.6, 139.5, 139.8,
D13/162, 156, 171, 158, 170, 177, 138.2,
D13/138.1, 139.2, 137.3, 139.1, 139.4;
174/66, 37-38; 200/5 R, 5 A, 1 B;
338/201, 202; 361/641, 622, 602, 627,
361/644, 660, 679.05, 118; 439/620.2
See application file for complete search history.

(56) **References Cited**

U.S. PATENT DOCUMENTS

D314,368 S * 2/1991 Schwartz D13/137.3
D357,460 S * 4/1995 Lovett D13/139.1

D364,379 S * 11/1995 Pogue et al. D13/160
D382,251 S * 8/1997 Tsui D13/137.1
D450,036 S * 11/2001 Okamoto D13/137.2
D452,842 S * 1/2002 Kajiwara et al. D13/110
D486,125 S * 2/2004 Lim D13/108
D520,451 S * 5/2006 Stekelenburg D13/137.3
D616,823 S * 6/2010 Shi D13/137.2
D619,535 S * 7/2010 Shi D13/137.2
D634,269 S * 3/2011 Griffin, Jr. D13/108
D673,506 S * 1/2013 Fishman D13/156
2013/0130551 A1 * 5/2013 Mayer et al. 439/620.21

* cited by examiner

Primary Examiner — Robert M Spear

Assistant Examiner — Rhea Shields

(74) *Attorney, Agent, or Firm* — The PL Law Group, PLLC

(57) **CLAIM**

The ornamental design for a power outlet, as shown and described.

DESCRIPTION

FIG. 1 is a perspective view of a power outlet, showing my new design;
FIG. 2 is a front view thereof;
FIG. 3 is a rear view thereof;
FIG. 4 is a left side view thereof;
FIG. 5 is a right side view thereof;
FIG. 6 is a top plan view thereof; and,
FIG. 7 is a bottom plan view thereof.
The broken lines in the figures illustrate unclaimed environment only and form no part of the claimed design.

1 Claim, 7 Drawing Sheets

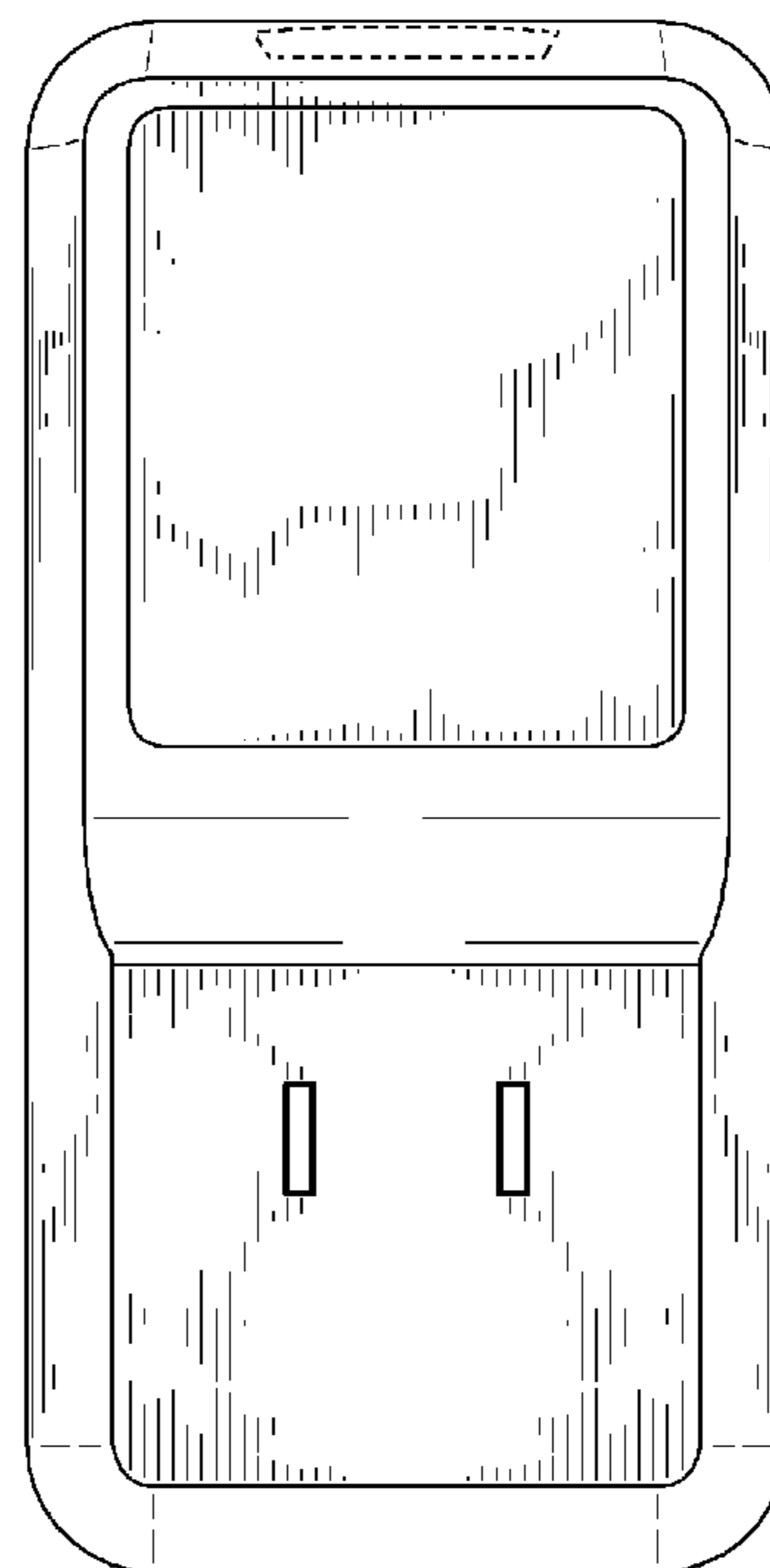
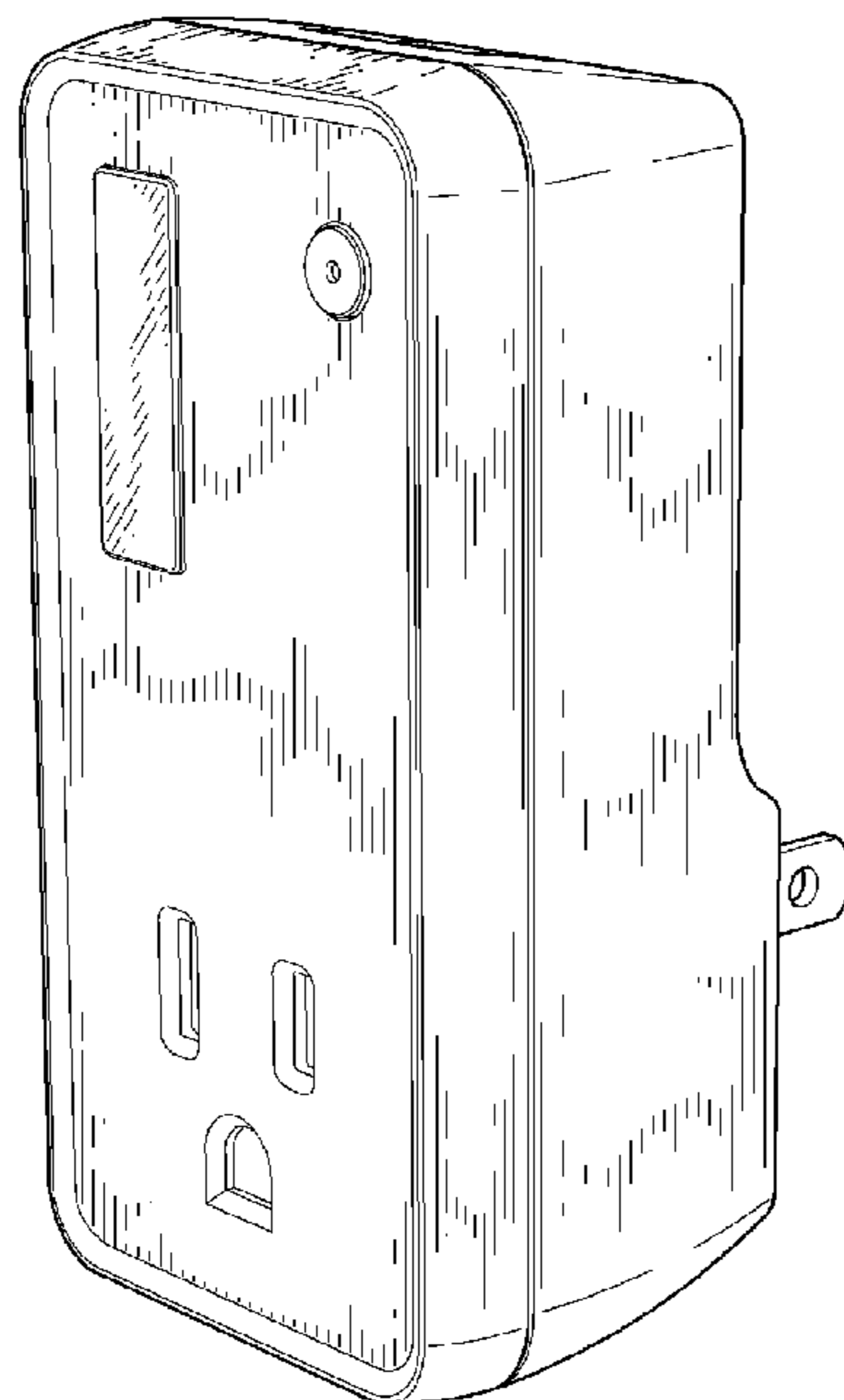

FIG. 1

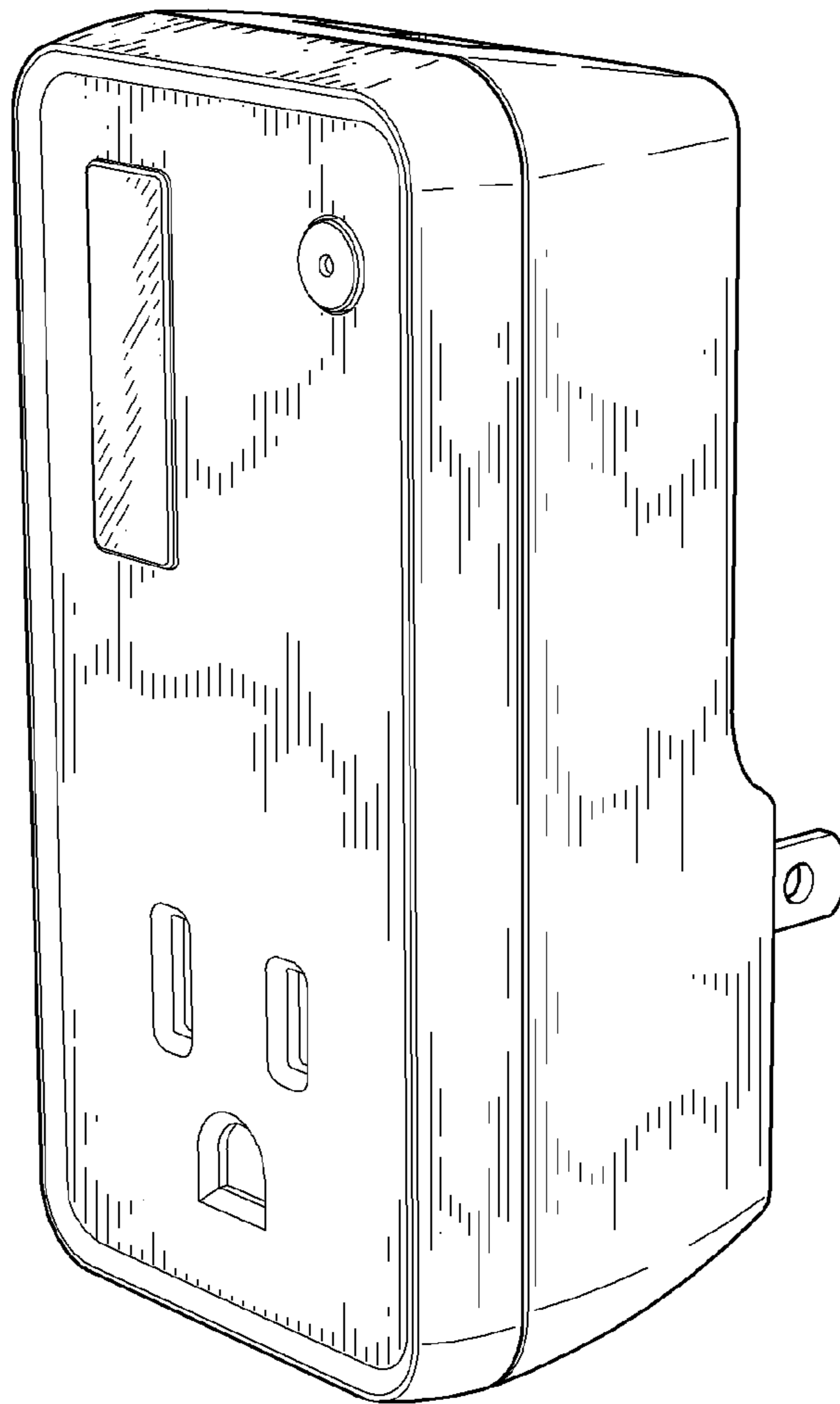

FIG. 2

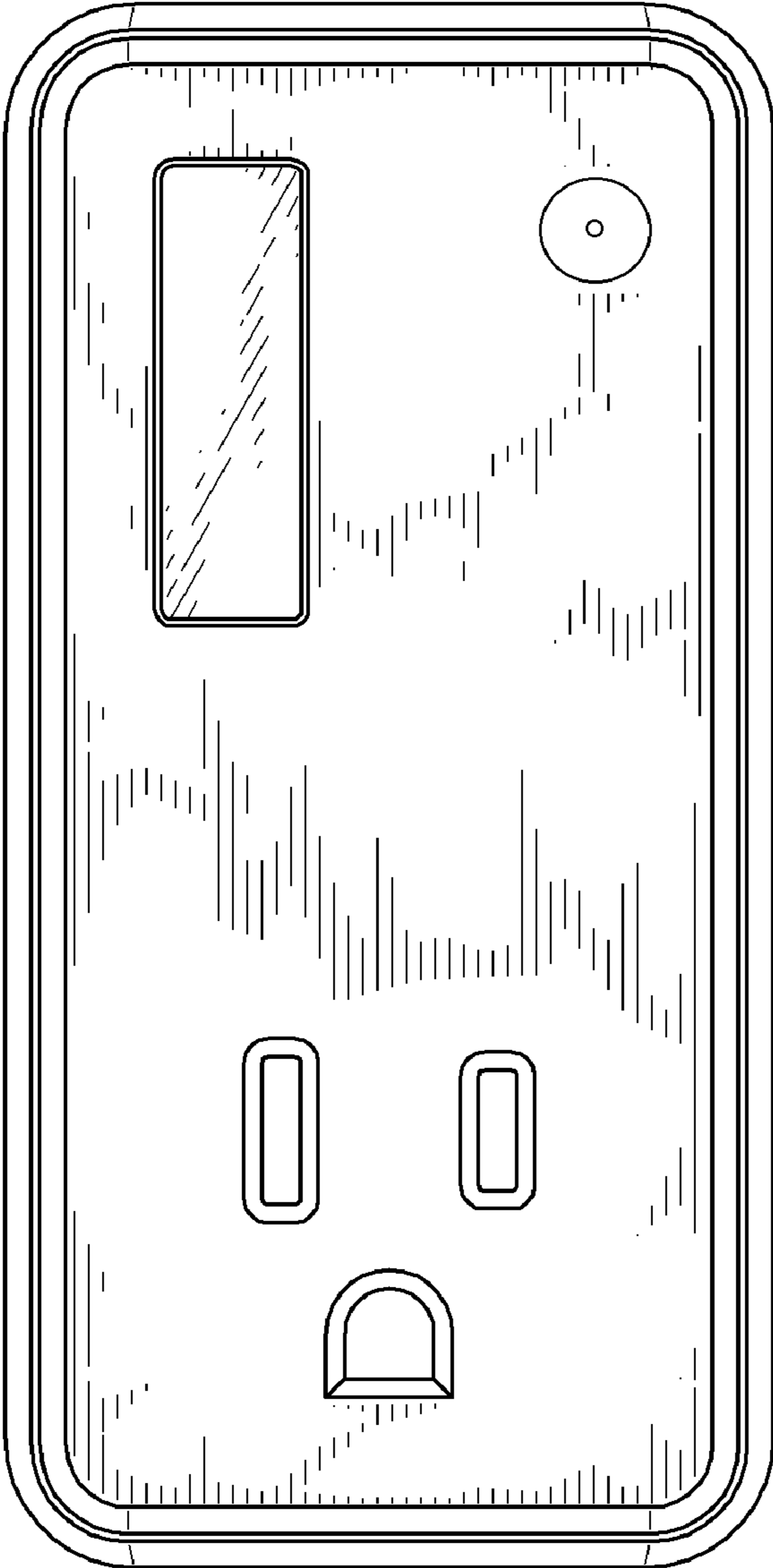

FIG. 3

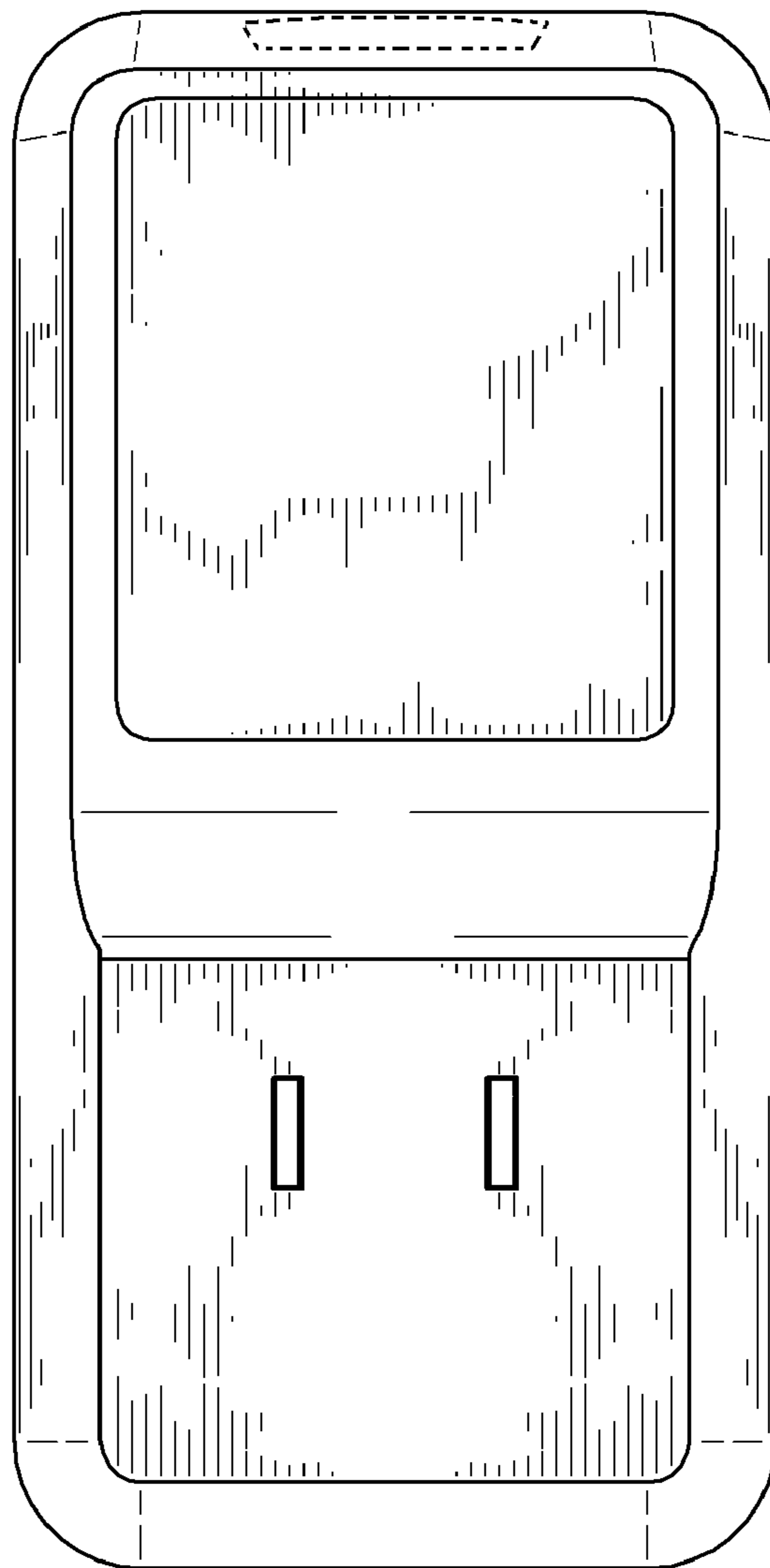

FIG. 4

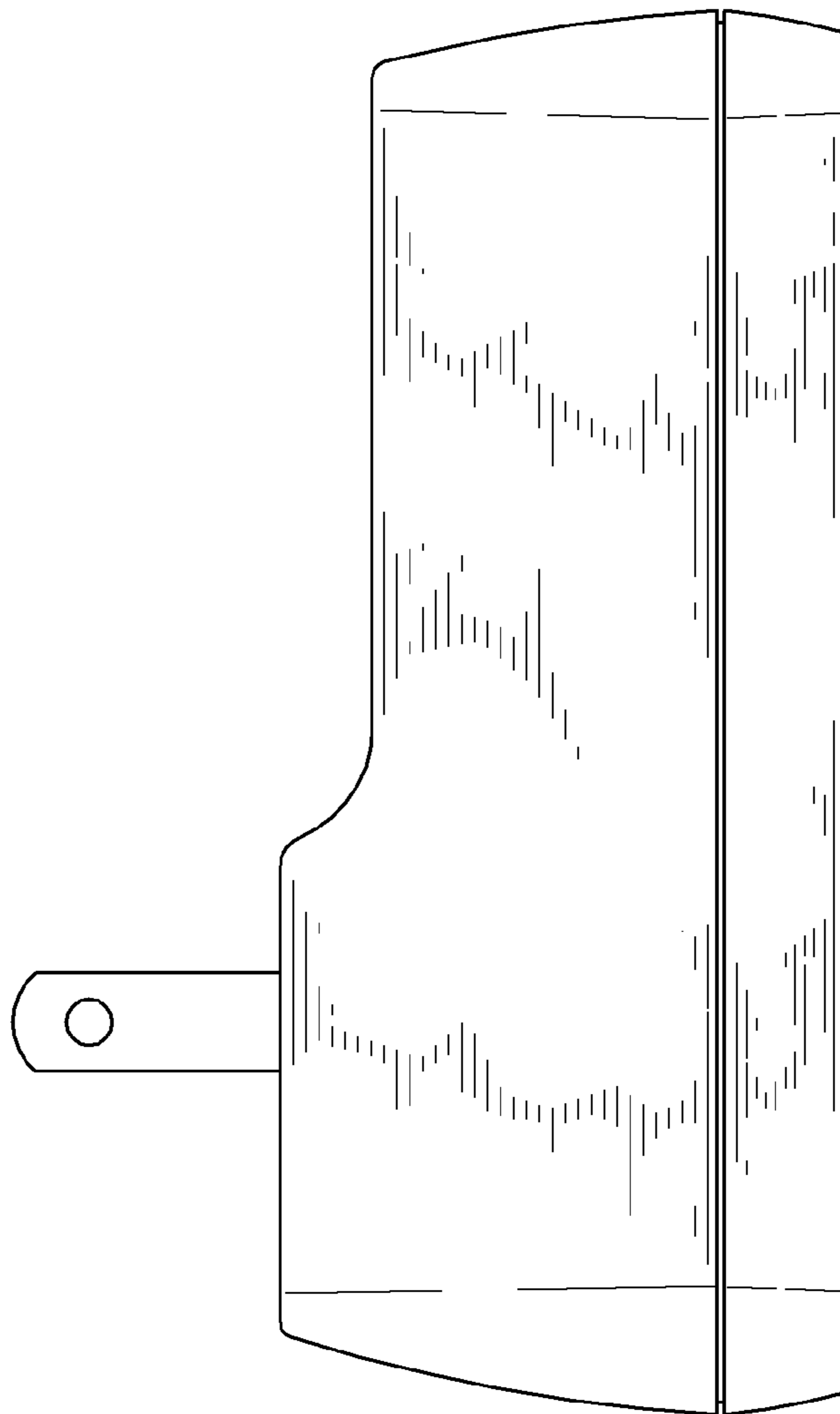

FIG. 5

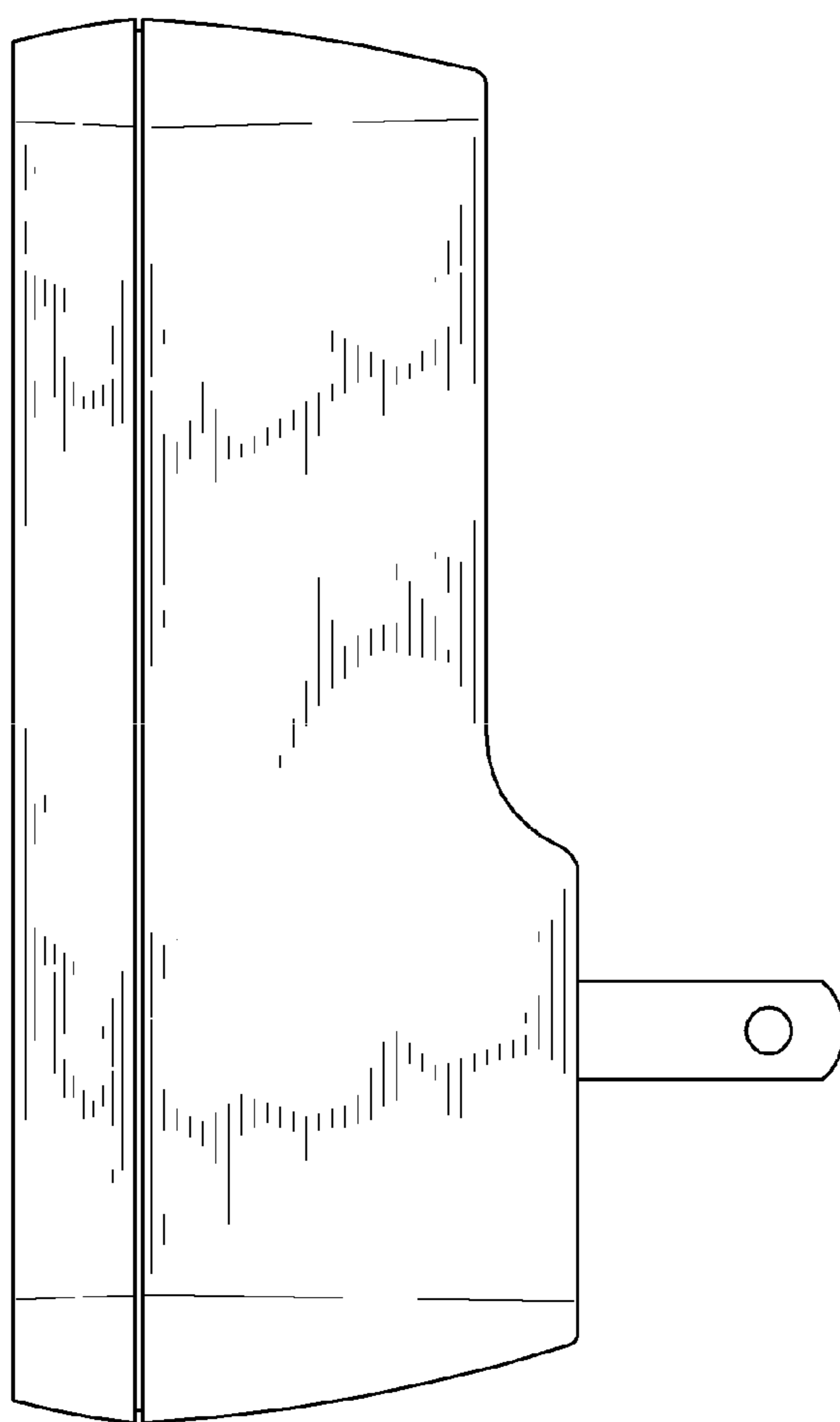

FIG. 6

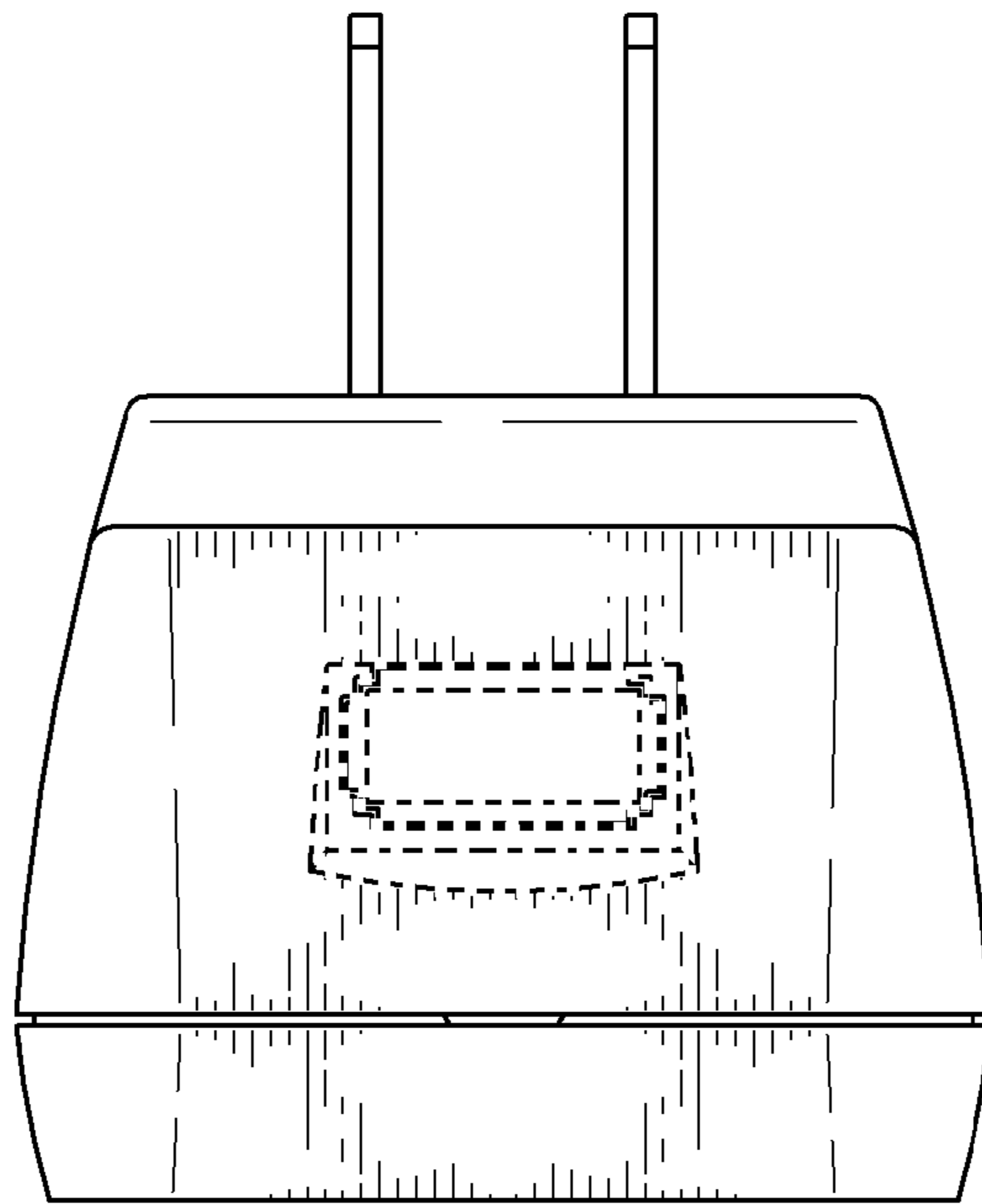

FIG. 7

