



US00D694701S

(12) **United States Design Patent**
Ouellette et al.

(10) **Patent No.:** **US D694,701 S**

(45) **Date of Patent:** **** Dec. 3, 2013**

(54) **CONSOLE**

(75) Inventors: **Benoit Ouellette**, Quebec (CA);
Mathieu Lavoie, Quebec (CA)

(73) Assignee: **Bombardier Inc.**, Dorval, Quebec (CA)

(**) Term: **14 Years**

(21) Appl. No.: **29/391,862**

(22) Filed: **May 13, 2011**

(51) **LOC (9) Cl.** **12-16**

(52) **U.S. Cl.**
USPC **D12/415**

(58) **Field of Classification Search**
USPC D12/415, 416, 417, 418, 419, 420;
296/36; 22/539; 224/404; 248/274.1,
248/284.1; D8/354; D9/423; D14/451-452
See application file for complete search history.

(56) **References Cited**

U.S. PATENT DOCUMENTS

D235,082 S *	5/1975	Weaver	D12/421
D252,540 S *	8/1979	Murphy	D12/419
D304,263 S *	10/1989	Mull	D12/419
D339,682 S *	9/1993	Phelps	D3/296
D375,548 S *	11/1996	Holbrook	D23/411
D478,102 S *	8/2003	Utsugi	D15/83
6,719,343 B2 *	4/2004	Emerling et al.	296/24.34
D507,777 S *	7/2005	Klopp et al.	D12/415
D536,580 S *	2/2007	Krieger et al.	D7/605
D589,870 S *	4/2009	Saint-Jalmes et al.	D12/345
D611,401 S *	3/2010	Saint-Jalmes et al.	D12/425
D615,478 S *	5/2010	Hynes	D12/415
D630,159 S *	1/2011	Saint-Jalmes et al.	D12/425
D634,698 S *	3/2011	Saint-Jalmes et al.	D12/423
7,914,059 B2 *	3/2011	Carnevali	296/24.34

8,066,313 B2 *	11/2011	Carnevali	296/24.34
8,136,217 B2 *	3/2012	Carnevali	29/525.01
8,157,310 B2 *	4/2012	Carnevali	296/24.34
8,162,368 B2 *	4/2012	Carnevali	296/24.34

* cited by examiner

Primary Examiner — Katrina A Betton

(74) *Attorney, Agent, or Firm* — Thomas & Karceski, PC

(57) **CLAIM**

The ornamental design for a console, as shown and described.

DESCRIPTION

FIG. 1 is a perspective, rear view of a console according to our design;
 FIG. 2 is a rear view of the console of FIG. 1;
 FIG. 3 is a top view of the console of FIG. 1;
 FIG. 4 is a left side view of the console of FIG. 1;
 FIG. 5 is a right side view of the console of FIG. 1; and,
 FIG. 6 is a perspective view of an aircraft cockpit, indicating one possible placement for the console of FIG. 1.
 Broken lines are included in various figures of the drawings to denote aspects of the console that form no part of the claimed design and to delimit the unclaimed boundaries of various surfaces that form part of the claimed design. In addition, unshaded surfaces form no part of the claimed design.
 In FIG. 6, broken lines are provided to show one contemplated placement location (e.g., the center of an aircraft cockpit) for the console of the present invention. The depiction of an aircraft cockpit is merely exemplary of one environment in which the present invention may be employed and is not intended to limit the applicability of the present invention with respect to other vehicles and/or locations within a vehicle.

1 Claim, 6 Drawing Sheets

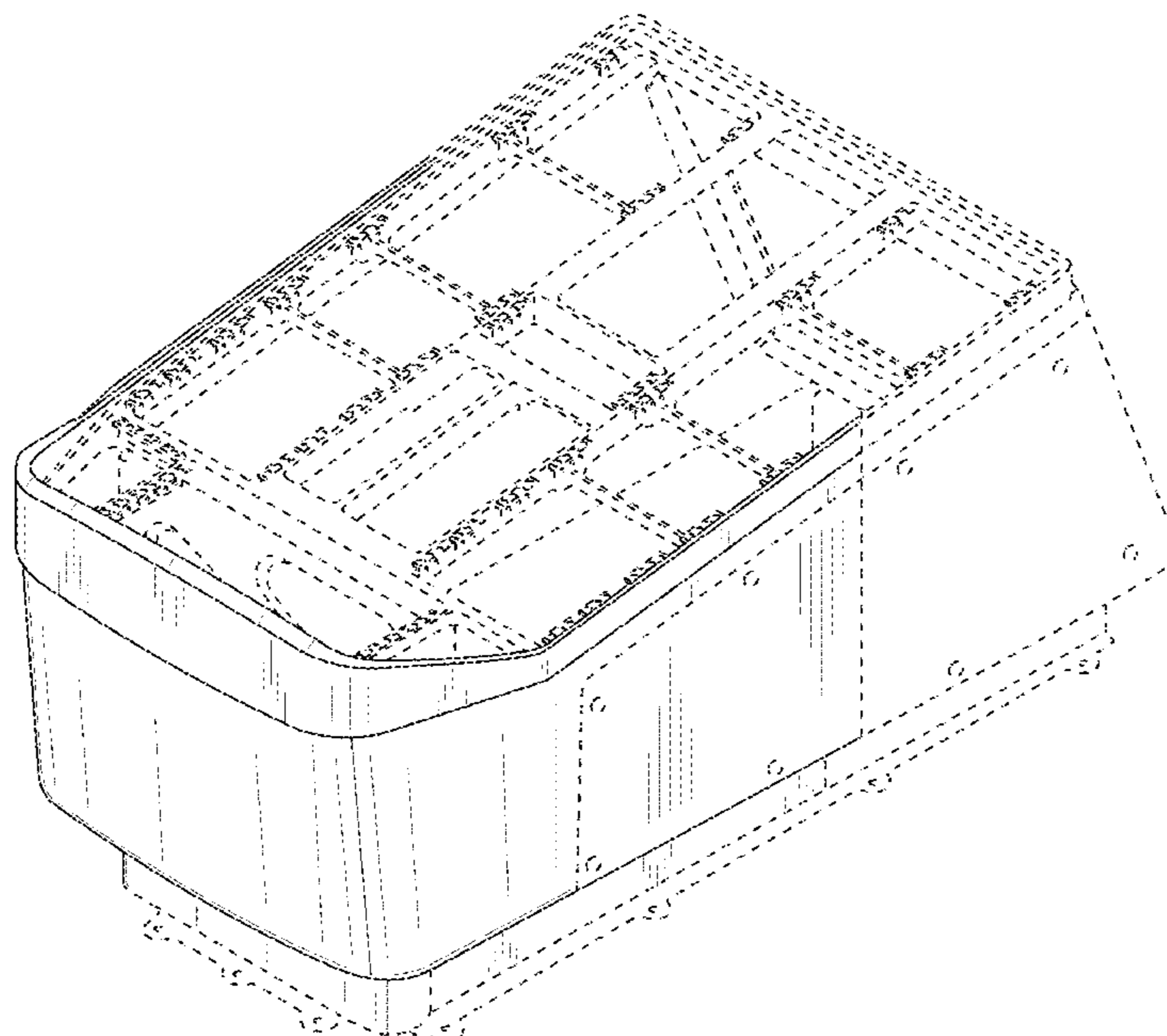

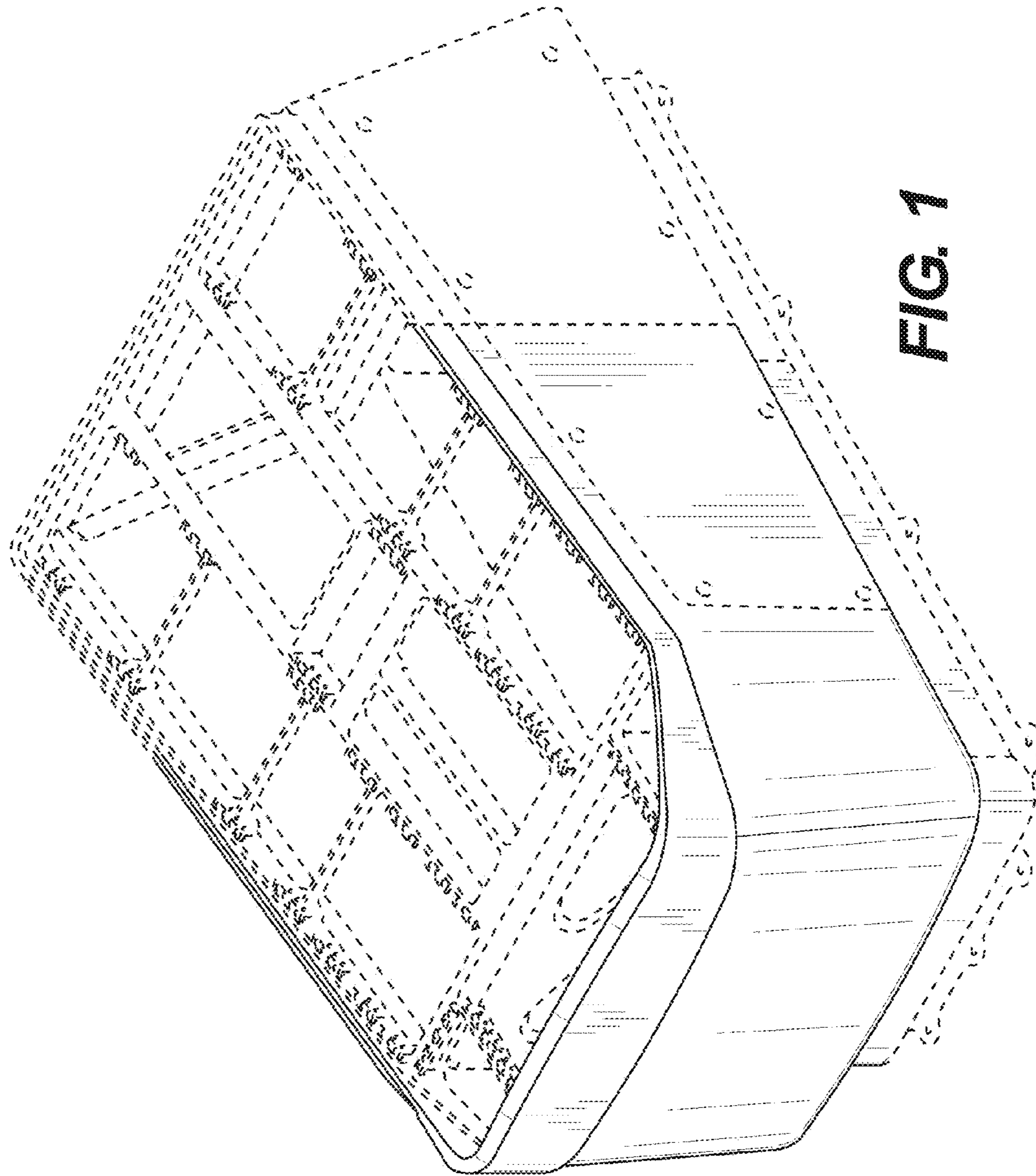

FIG. 1

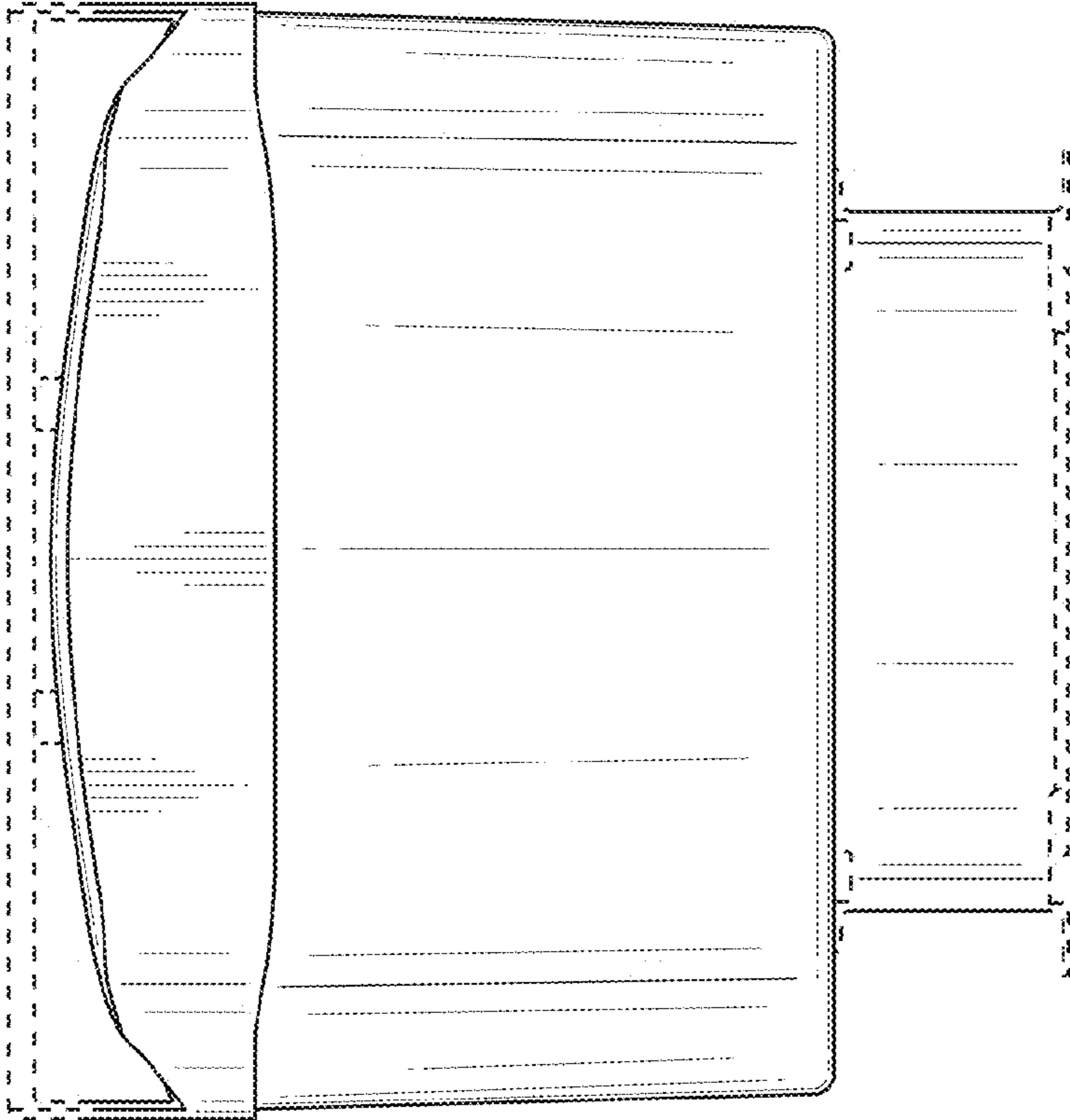

FIG. 2

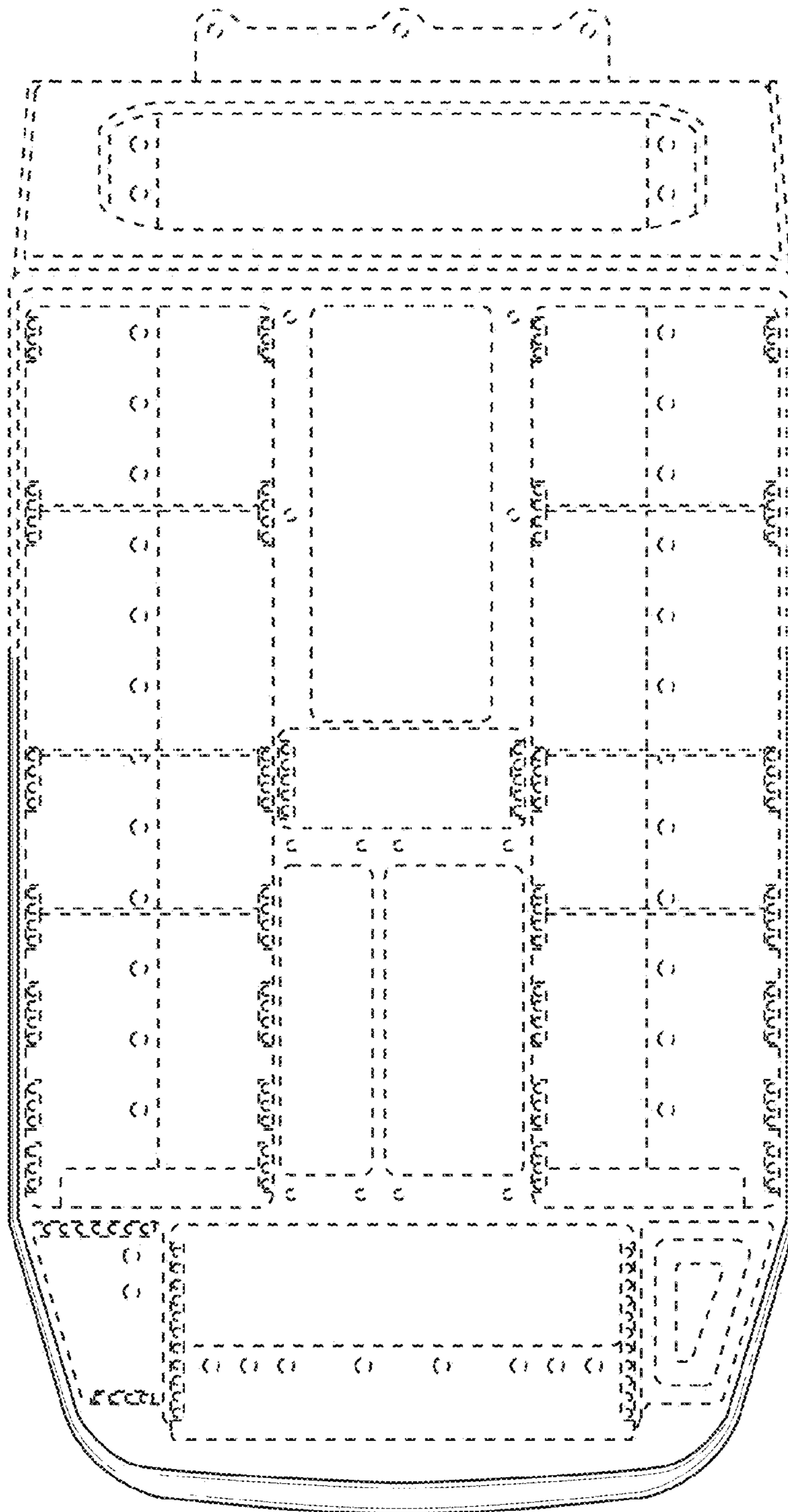

FIG. 3

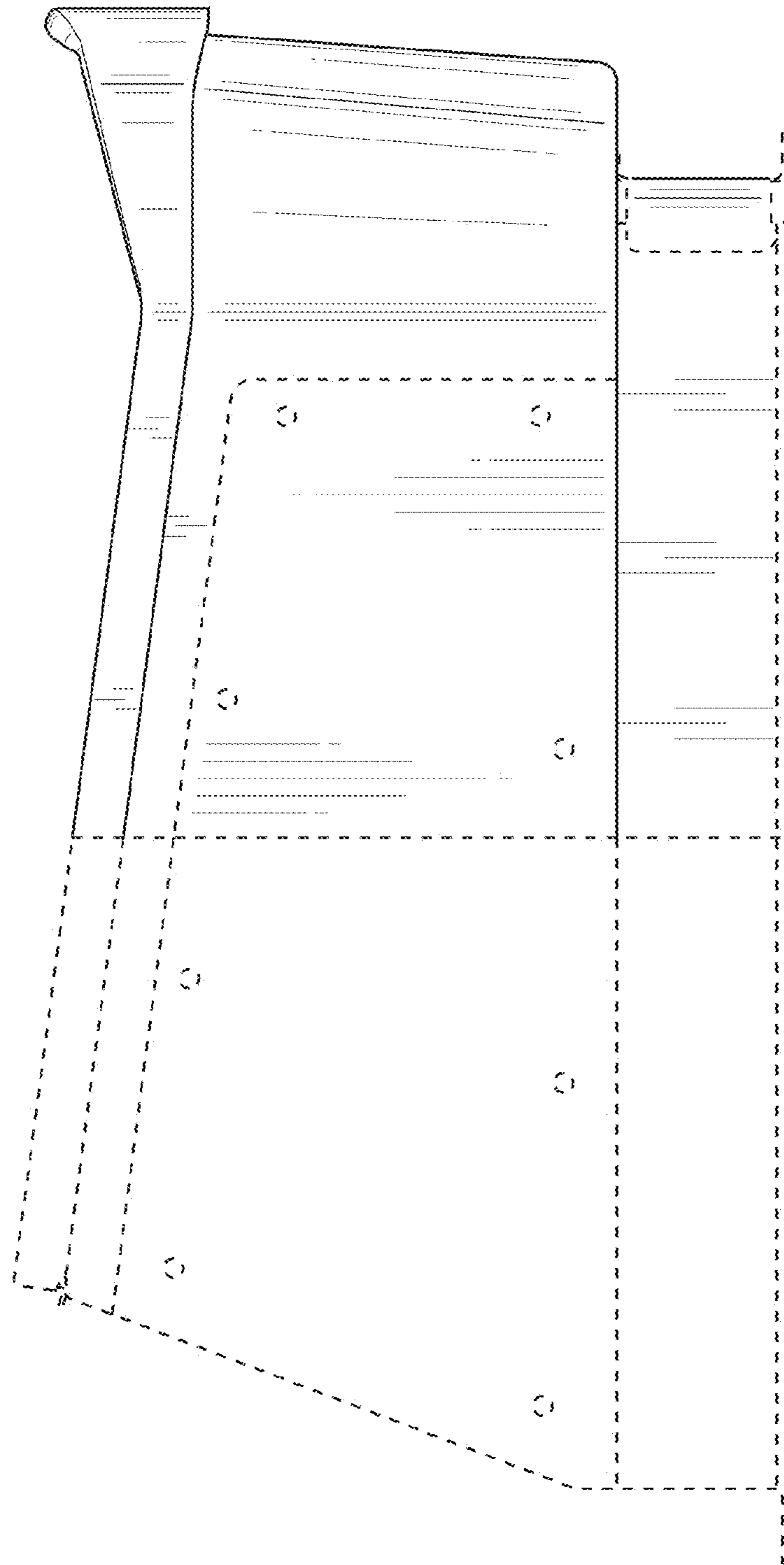

FIG. 4

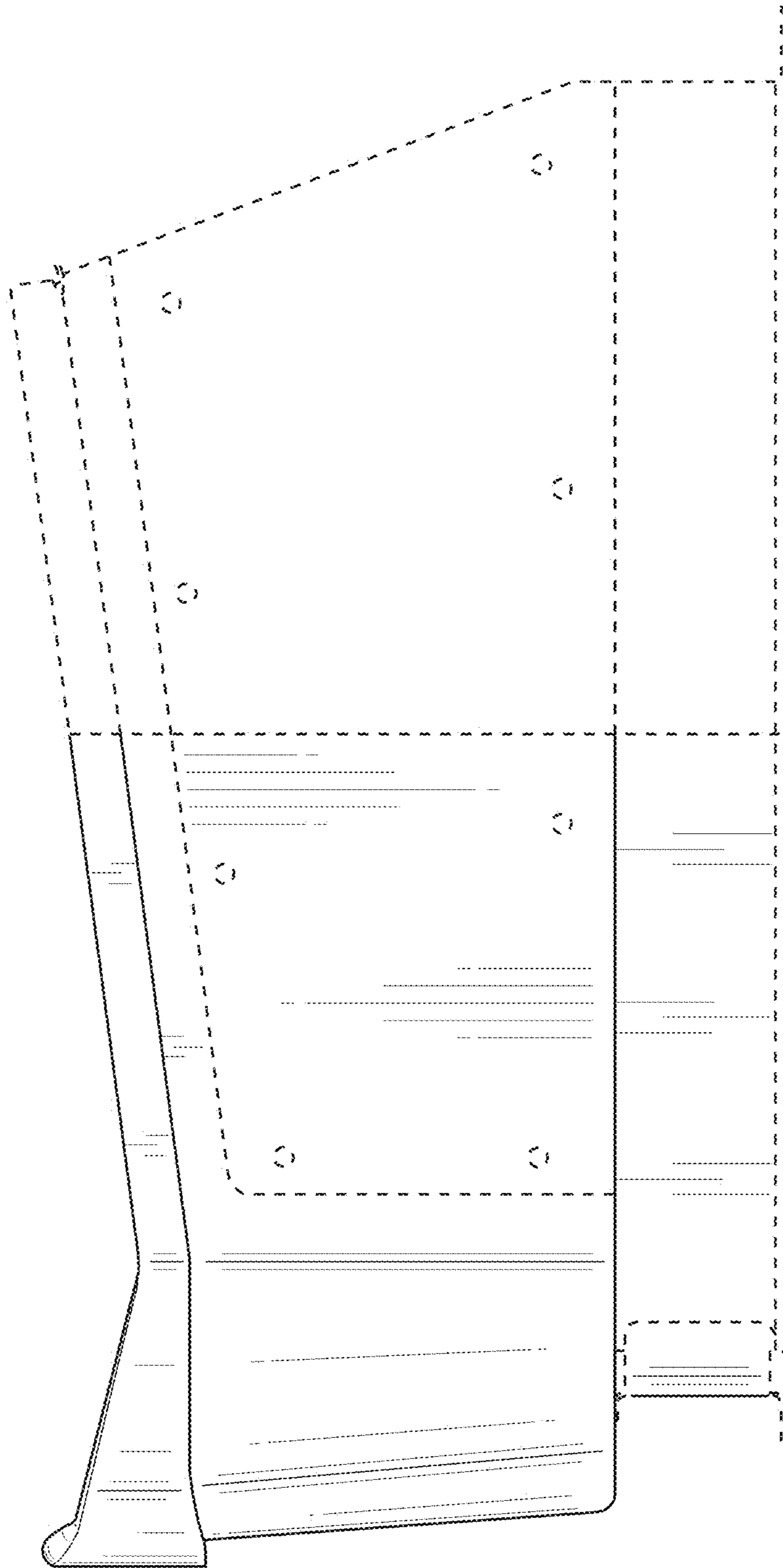

FIG. 5

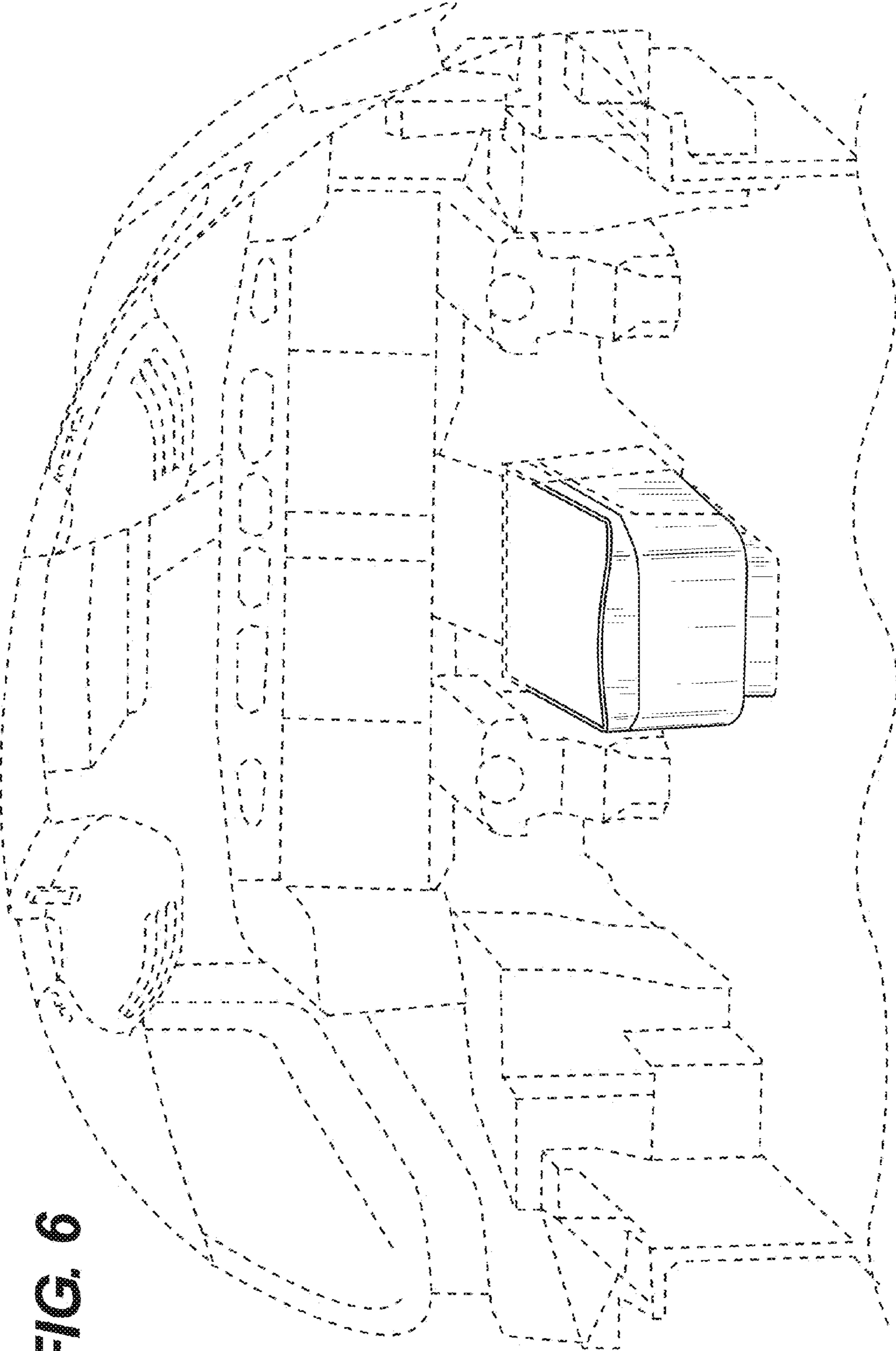

FIG. 6