

US00D694691S

(12) **United States Design Patent**
Matsueda

(10) **Patent No.:** **US D694,691 S**
(45) **Date of Patent:** **** Dec. 3, 2013**

(54) **REAR DOOR FOR AN AUTOMOBILE**

(75) Inventor: **Jirou Matsueda**, Ikeda (JP)
(73) Assignee: **Daihatsu Kogyo Kabushiki Kaisha**,
Ikeda-shi, Osaka-fu (JP)

(**) Term: **14 Years**

(21) Appl. No.: **29/420,038**

(22) Filed: **May 3, 2012**

(30) **Foreign Application Priority Data**

Nov. 7, 2011 (JP) 2011-025615

(51) **LOC (9) Cl.** **12-16**

(52) **U.S. Cl.**
USPC **D12/196**

(58) **Field of Classification Search**
USPC D12/196, 90-92, 86; 296/181.1, 181.5
See application file for complete search history.

(56) **References Cited**

U.S. PATENT DOCUMENTS

D616,333 S	5/2010	Cartabiano et al.	
D652,351 S	1/2012	Ikuma	
D660,211 S *	5/2012	Ikuma et al.	D12/196
D660,213 S *	5/2012	Ikuma et al.	D12/196
D660,758 S *	5/2012	Hakamata et al.	D12/196
D660,759 S *	5/2012	Matsumoto et al.	D12/196

OTHER PUBLICATIONS

Fiat Punto; <http://www.lincah.com/wp-content/uploads/2009/08/2010-Fiat-Punto-Evo-Front-Side-View;> (2010).
Fiat Punto; http://pictures.topspeed.com/IMG/crop/200908/2010-fiat-punto-evo-1_800x0w.jpg (2010).
Kia Venga; <http://lincah.com/wp-content/uploads/2009/08/2010-Kia-Venga-Front-Side-View.jpg> (2010).
Kia Venga; <http://www.lincah.com/wp-content/uploads/2009/08/2010-Kia-Venga-Rear-Side-View.jpg> (2010).

* cited by examiner

Primary Examiner — Melody Brown
(74) *Attorney, Agent, or Firm* — Finnegan, Henderson, Farabow, Garrett & Dunner, LLP

(57) **CLAIM**

The ornamental design for a rear door for an automobile, as shown and described.

DESCRIPTION

FIG. 1 is a left front perspective view of a rear door for an automobile showing my new design;
FIG. 2 is a right front perspective view thereof;
FIG. 3 is a front elevation view thereof;
FIG. 4 is a rear elevation view thereof;
FIG. 5 is a top plan view thereof;
FIG. 6 is a bottom view thereof;
FIG. 7 is a right side view thereof; and,
FIG. 8 is a left side view thereof.
My design includes a mirror image of the embodiment depicted.

1 Claim, 4 Drawing Sheets

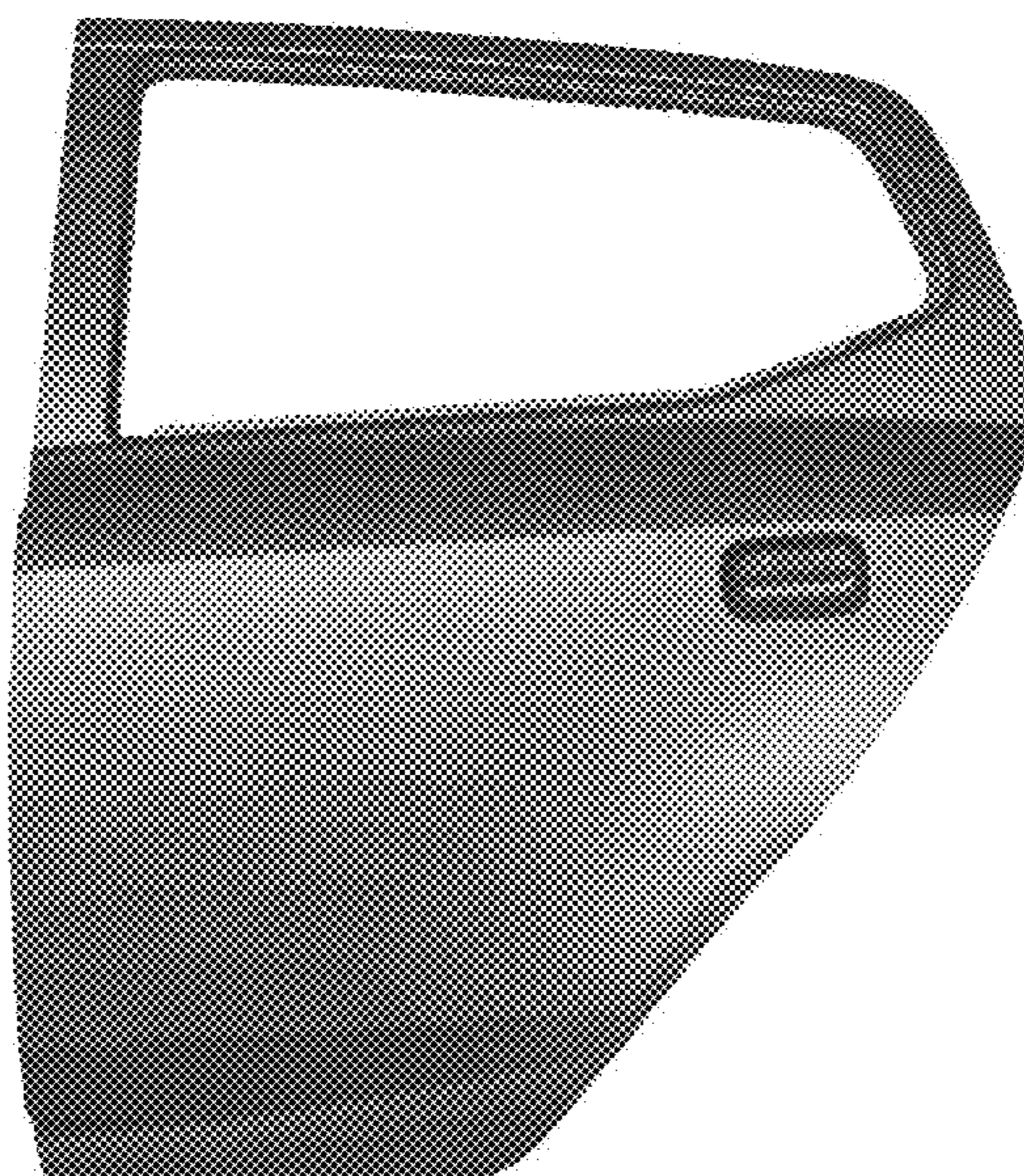

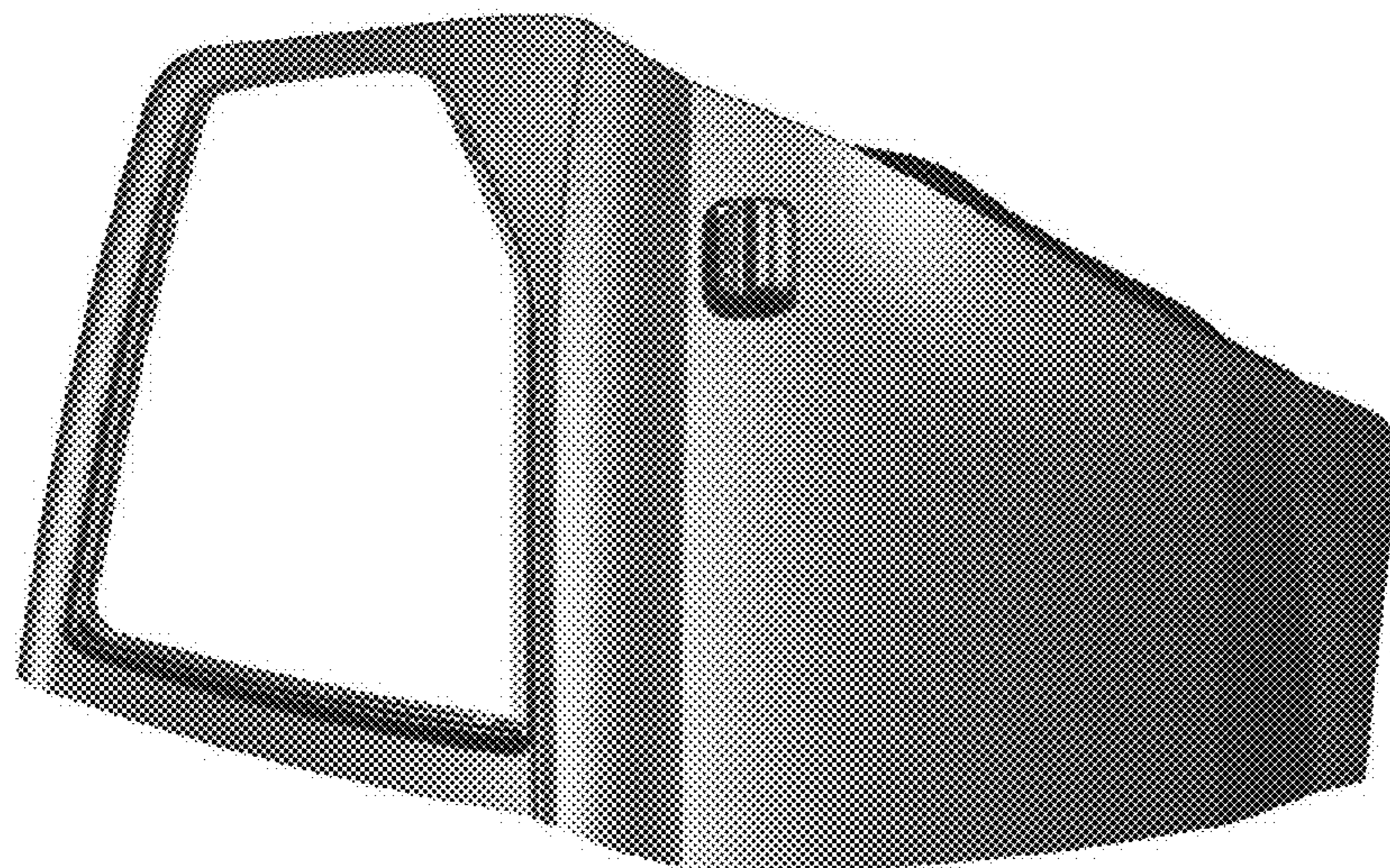

FIG. 2

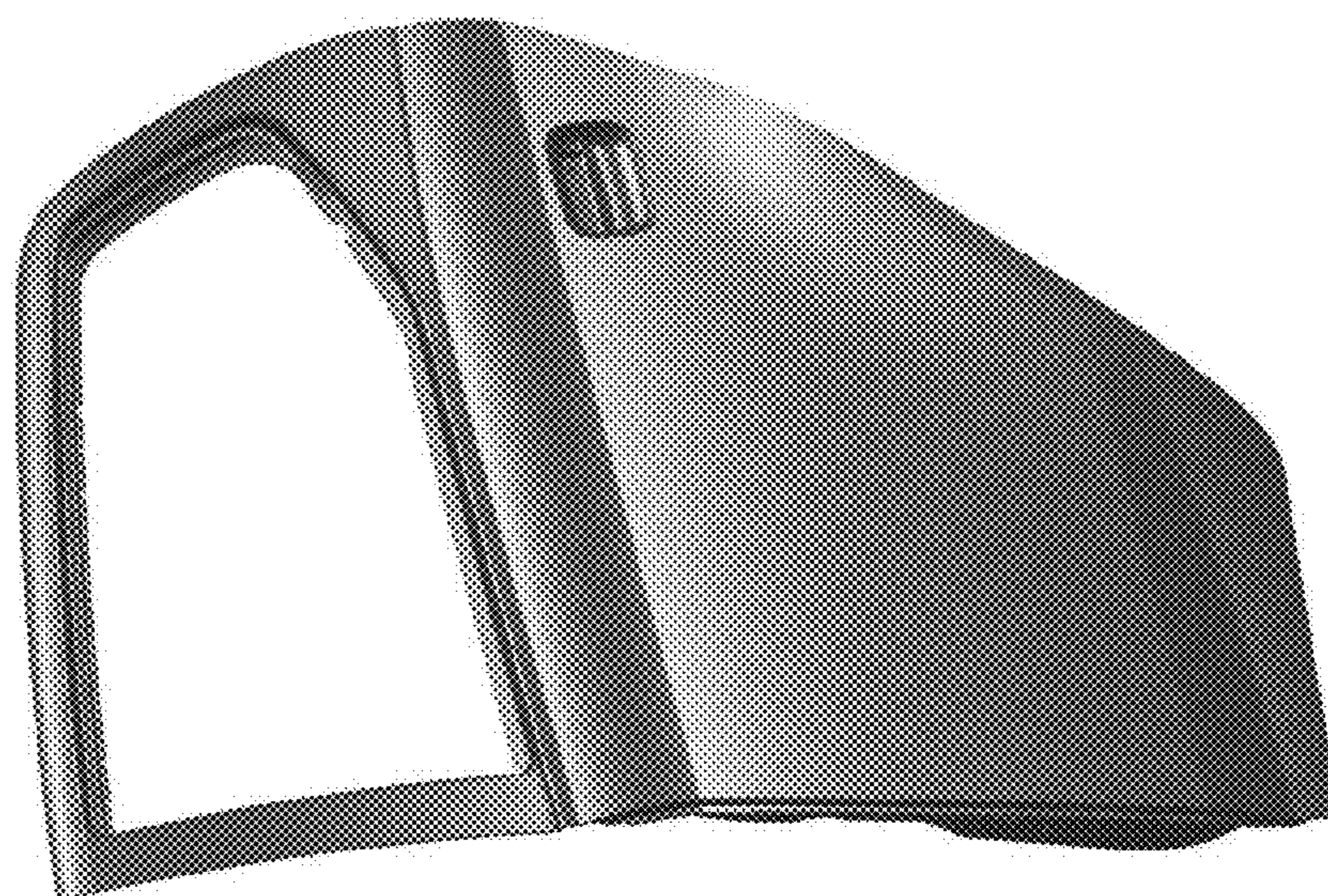

FIG. 1

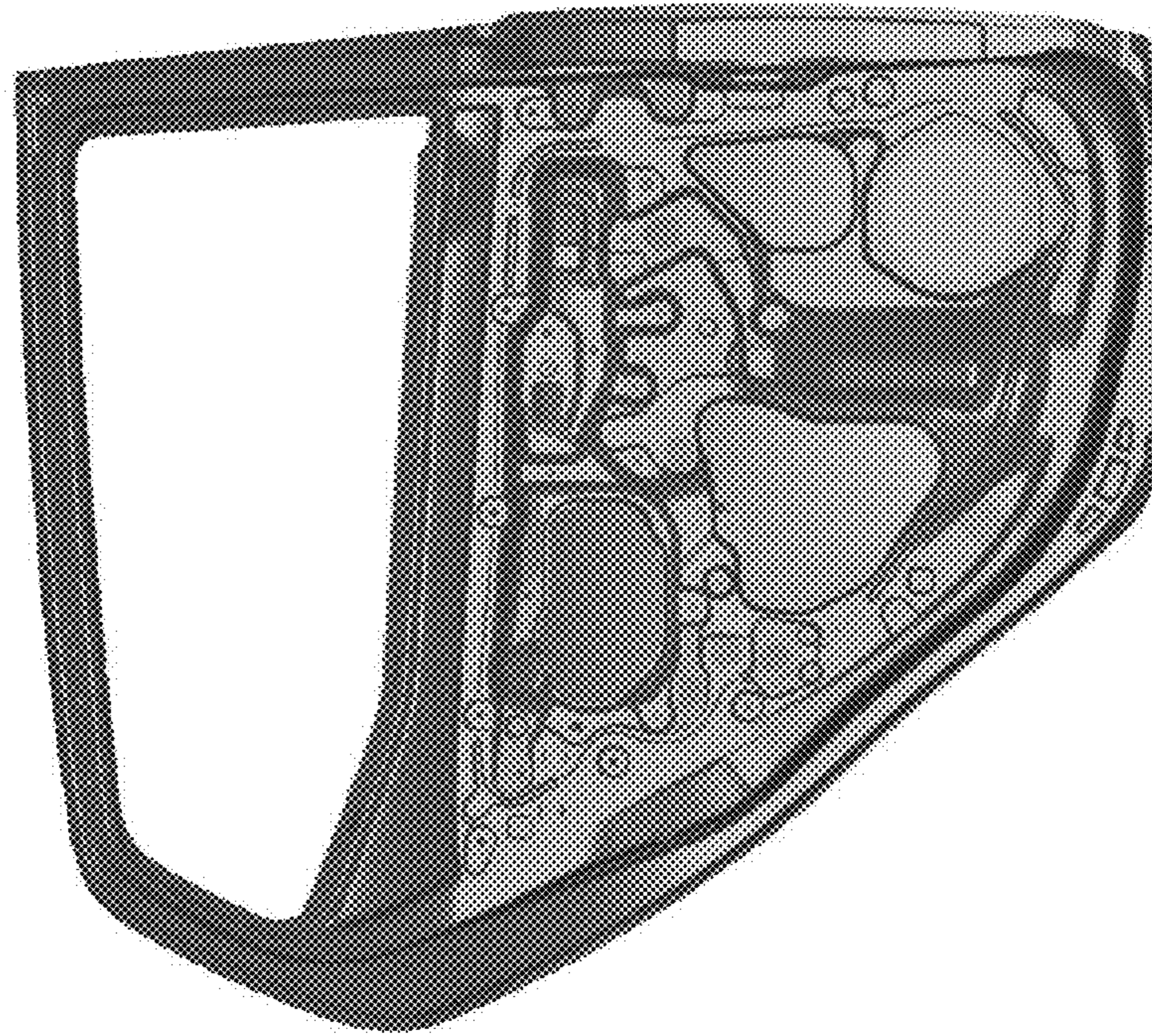

FIG. 4

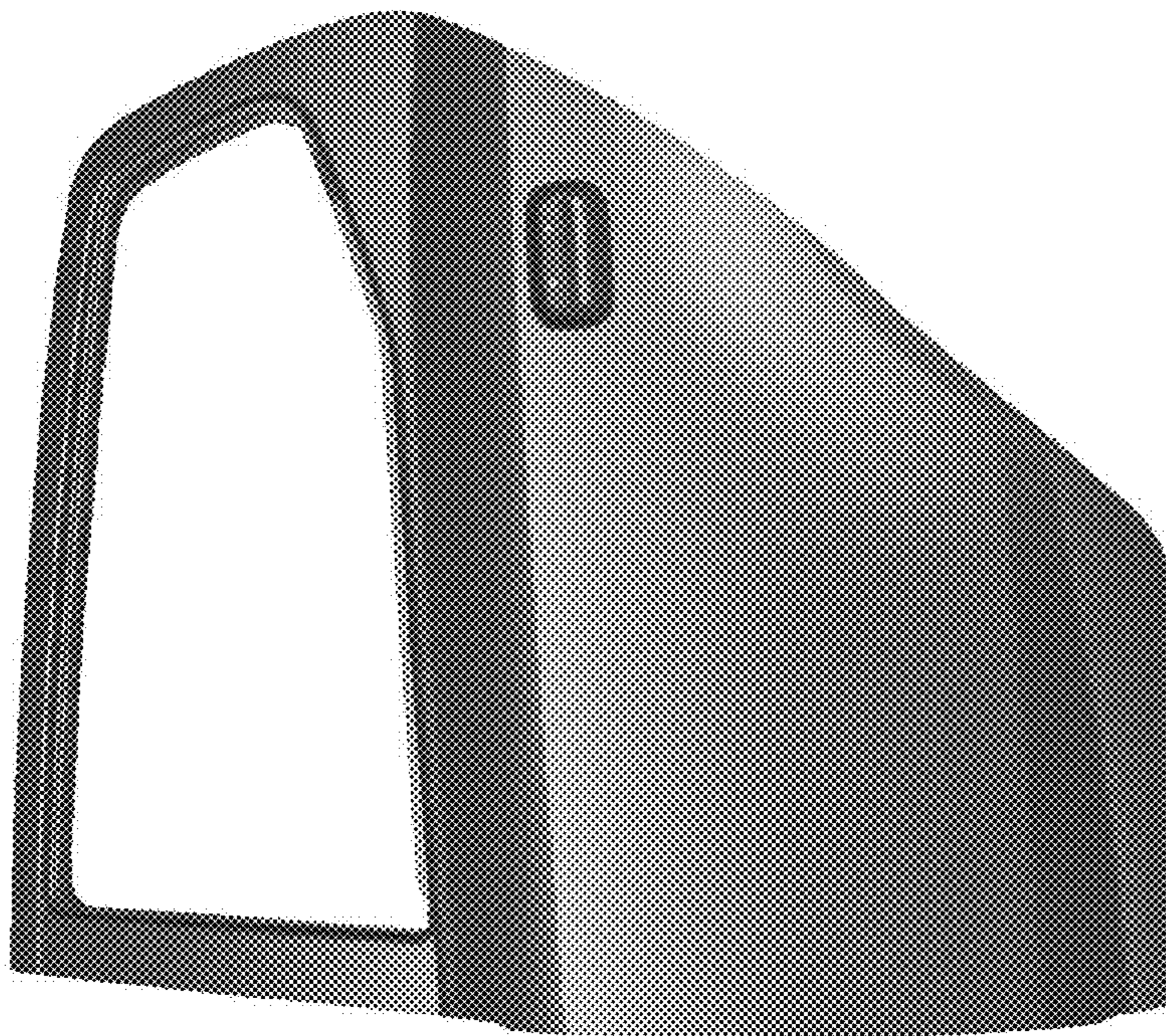

FIG. 3

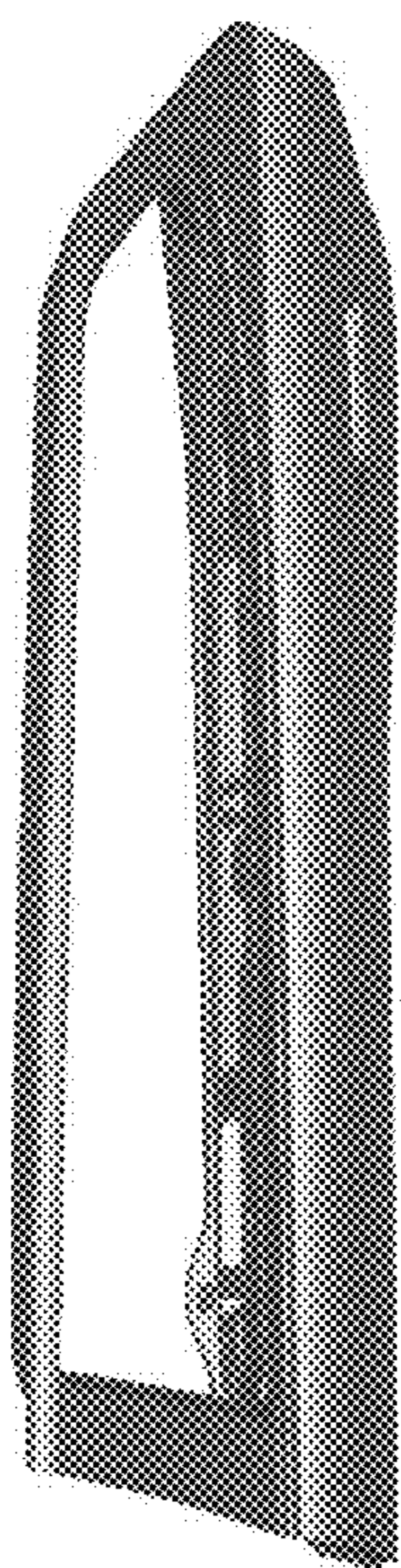

FIG. 5

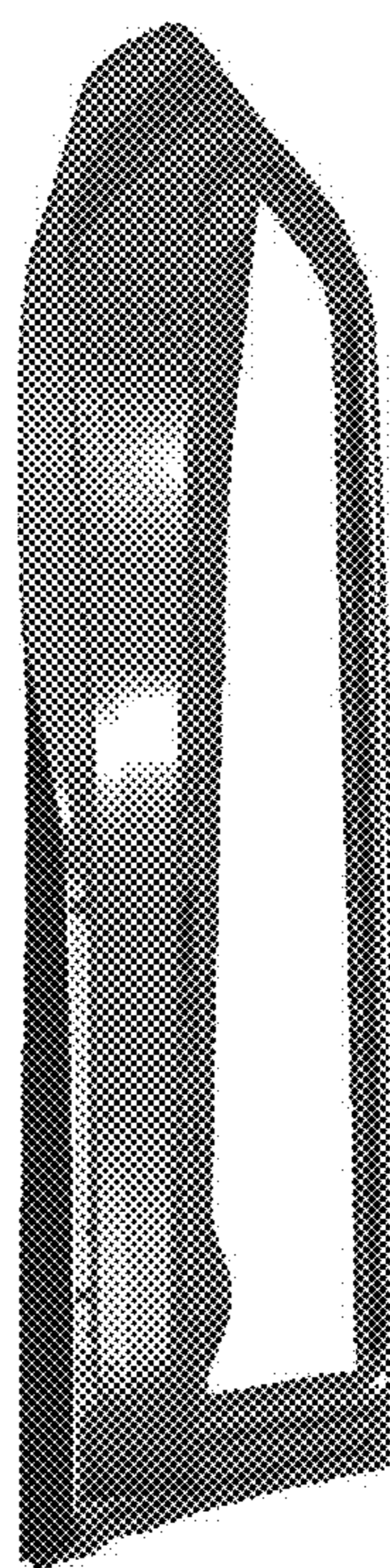

FIG. 6

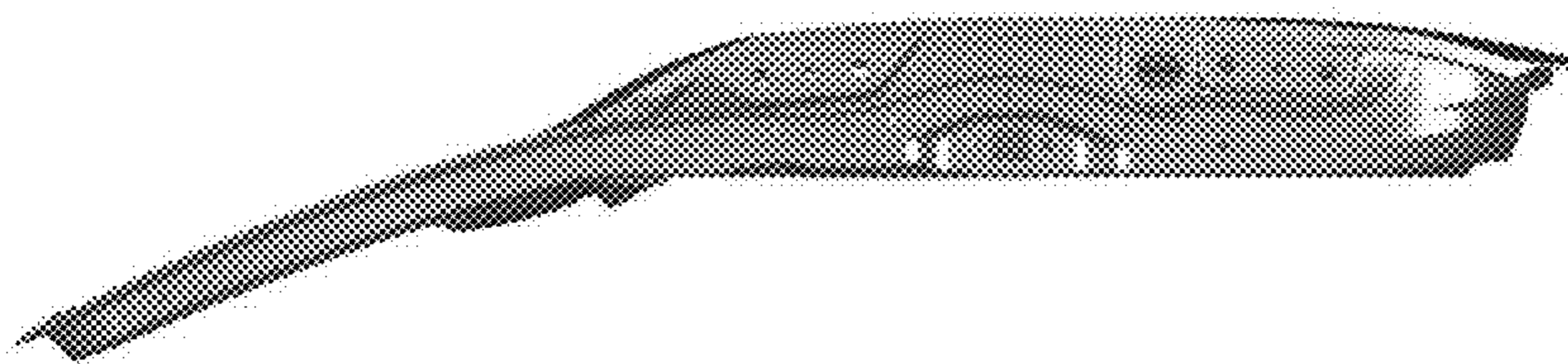

FIG. 8

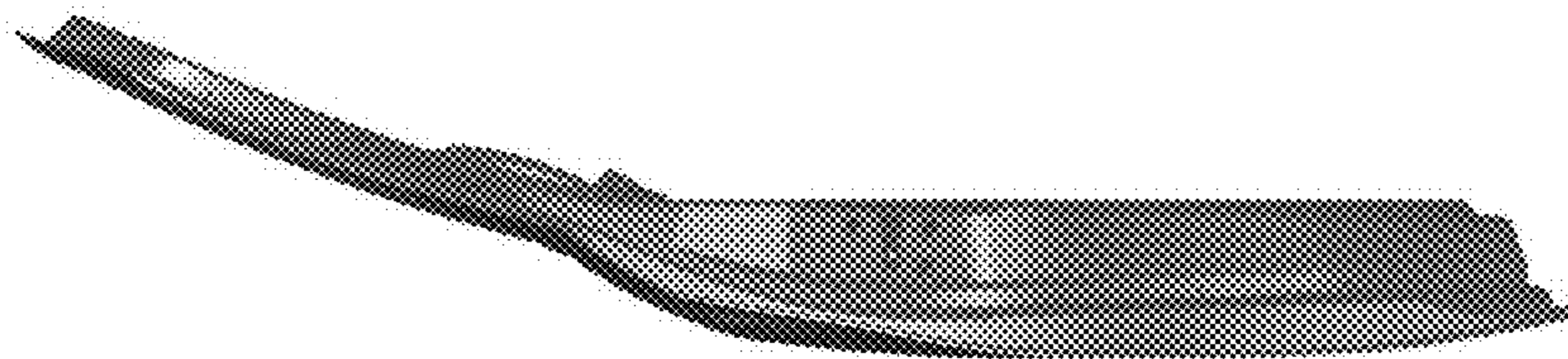

FIG. 7