

US00D694583S

(12) **United States Design Patent**  
**Norland**

(10) **Patent No.:** **US D694,583 S**  
(45) **Date of Patent:** **\*\* Dec. 3, 2013**

- (54) **BLENDER JAR**
- (71) Applicant: **Whirlpool Corporation**, Benton Harbor, MI (US)
- (72) Inventor: **Leif A. Norland**, Saint Joseph, MI (US)
- (73) Assignee: **Whirlpool Corporation**, Benton Harbor, MI (US)

D488,344 S *	4/2004	Seum et al. ....	D7/384
D502,047 S *	2/2005	Ledingham et al. ....	D7/384
D526,531 S *	8/2006	Drees et al. ....	D7/378
D533,395 S *	12/2006	Drees et al. ....	D7/378
D552,412 S *	10/2007	Steiner ....	D7/378
D577,537 S *	9/2008	Lee ....	D7/386
7,581,688 B2 *	9/2009	Mally ....	241/30
D605,462 S *	12/2009	Picozza et al. ....	D7/386
D617,136 S *	6/2010	Bock et al. ....	D7/378
D637,870 S *	5/2011	Bock ....	D7/412
D644,480 S *	9/2011	Czach et al. ....	D7/384

(\*\*) Term: **14 Years**

\* cited by examiner

(21) Appl. No.: **29/447,368**

*Primary Examiner* — Ricky Pham

(22) Filed: **Mar. 1, 2013**

(57) **CLAIM**

(51) **LOC (9) Cl.** ..... **31-00**

I claim the ornamental design for a blender jar, as shown and described.

(52) **U.S. Cl.**

USPC ..... **D7/413**; D7/376; D7/378; D7/412

**DESCRIPTION**

(58) **Field of Classification Search**

USPC ..... D7/301–313, 316–326, 356–357, 368,  
D7/372–386, 391–398, 412–415, 503, 515,  
D7/665–666, 679, 691–693; 99/280, 326,  
99/348, 492, 508–512; 241/30–37.5, 98,  
241/101.01–101.2, 166–169.1, 172, 272,  
241/285.1–285.3, 291, 292.1; 366/64–67,  
366/98, 129, 142–144, 192–211, 241–254,  
366/262, 279–292, 325.8, 325.92,  
366/341–347; 416/75–77, 70 R, 163

See application file for complete search history.

FIG. 1 is a top perspective view of a blender jar showing my new design;  
FIG. 2 is a first side elevational view of the blender jar of FIG. 1;  
FIG. 3 is a second side elevational view of the blender jar of FIG. 1;  
FIG. 4 is a third side elevational view of the blender jar of FIG. 1;  
FIG. 5 is a fourth side elevational view of the blender jar of FIG. 1;  
FIG. 6 is a top plan view of the blender jar of FIG. 1; and,  
FIG. 7 is a bottom plan view of the blender jar of FIG. 1.  
The broken lines shown in the drawings are for illustrative purposes only and form no part of the claimed design.

(56) **References Cited**

**U.S. PATENT DOCUMENTS**

D444,995 S *	7/2001	Thackray .....	D7/386
6,402,365 B1 *	6/2002	Wong .....	366/206

**1 Claim, 7 Drawing Sheets**

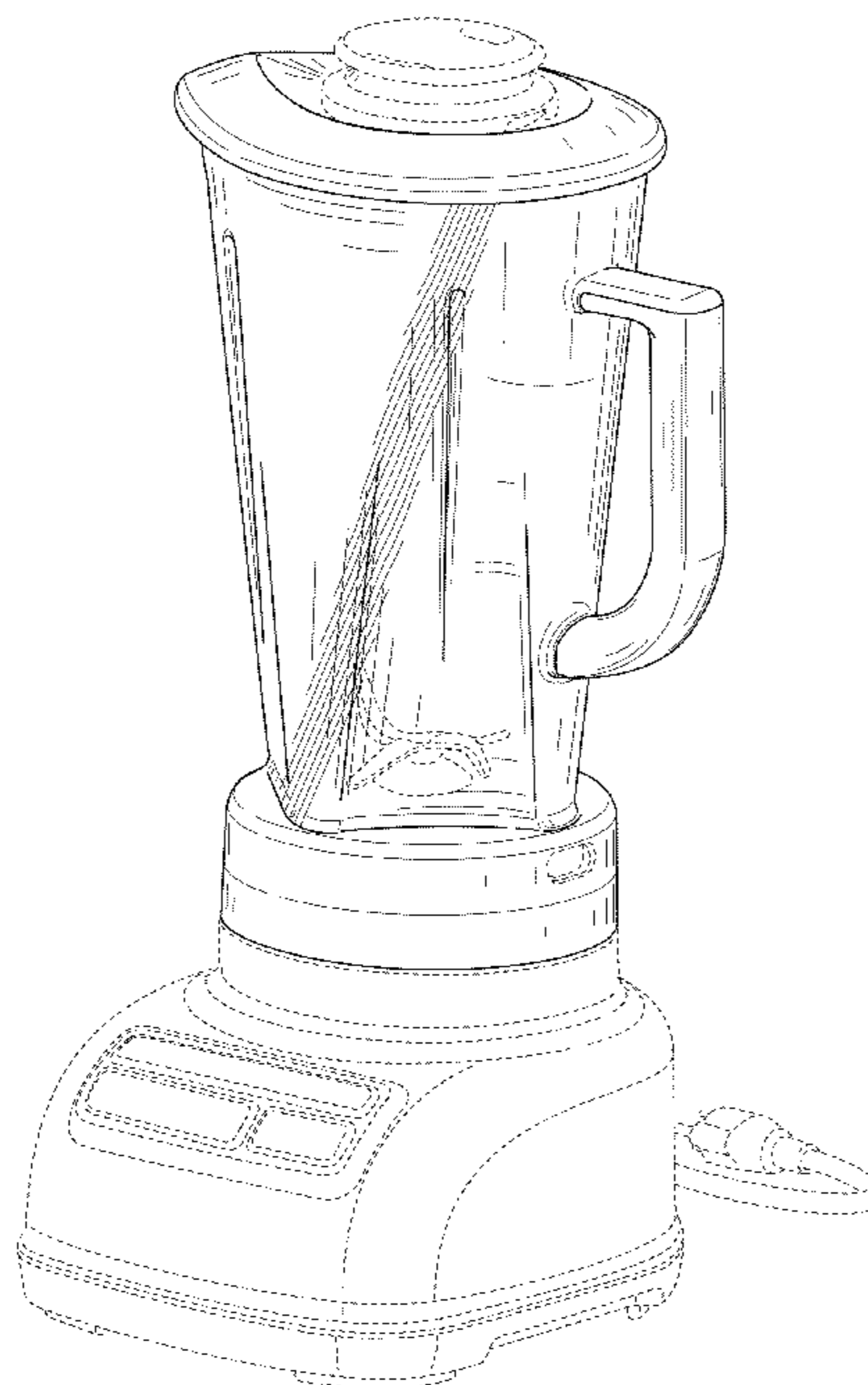

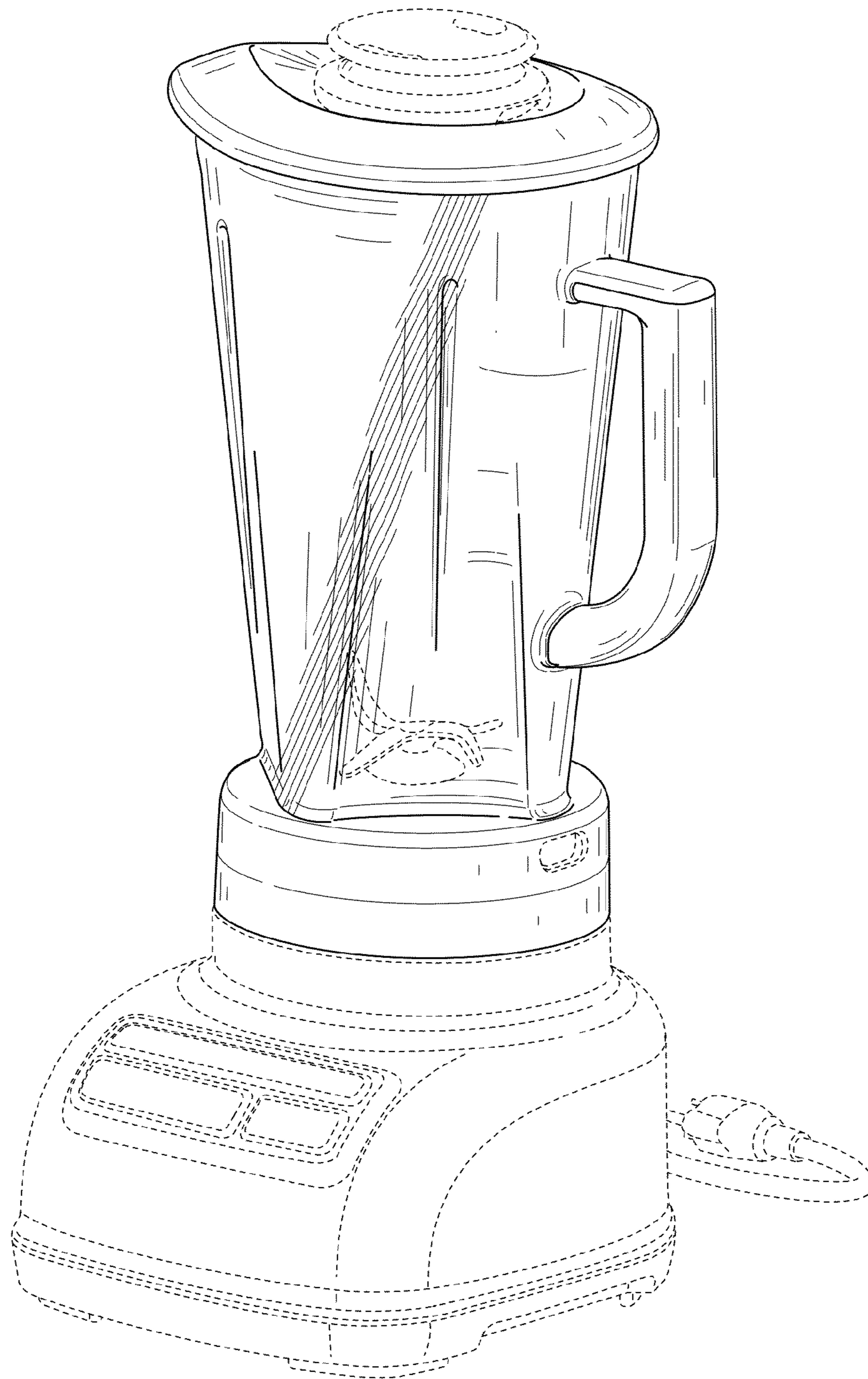
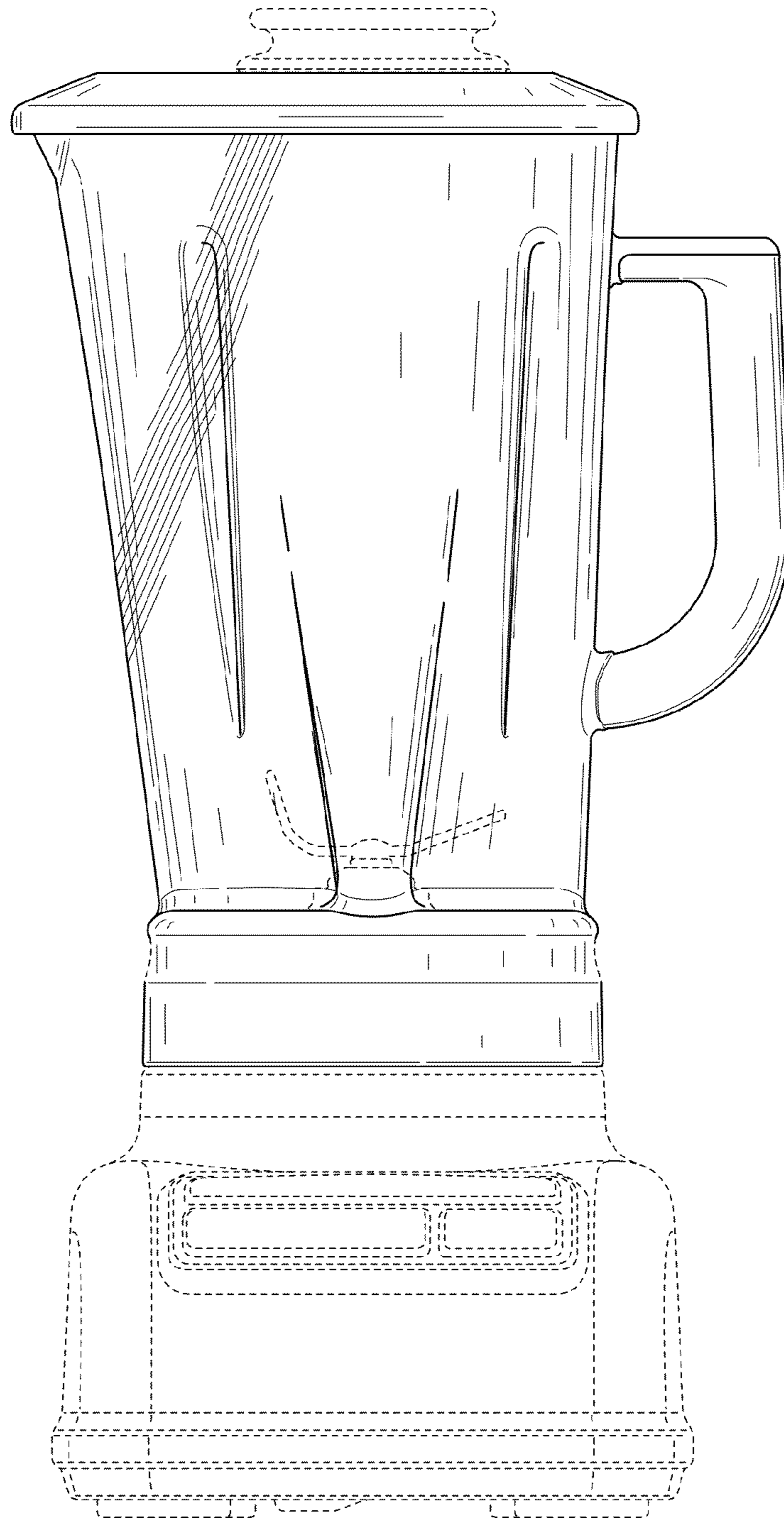
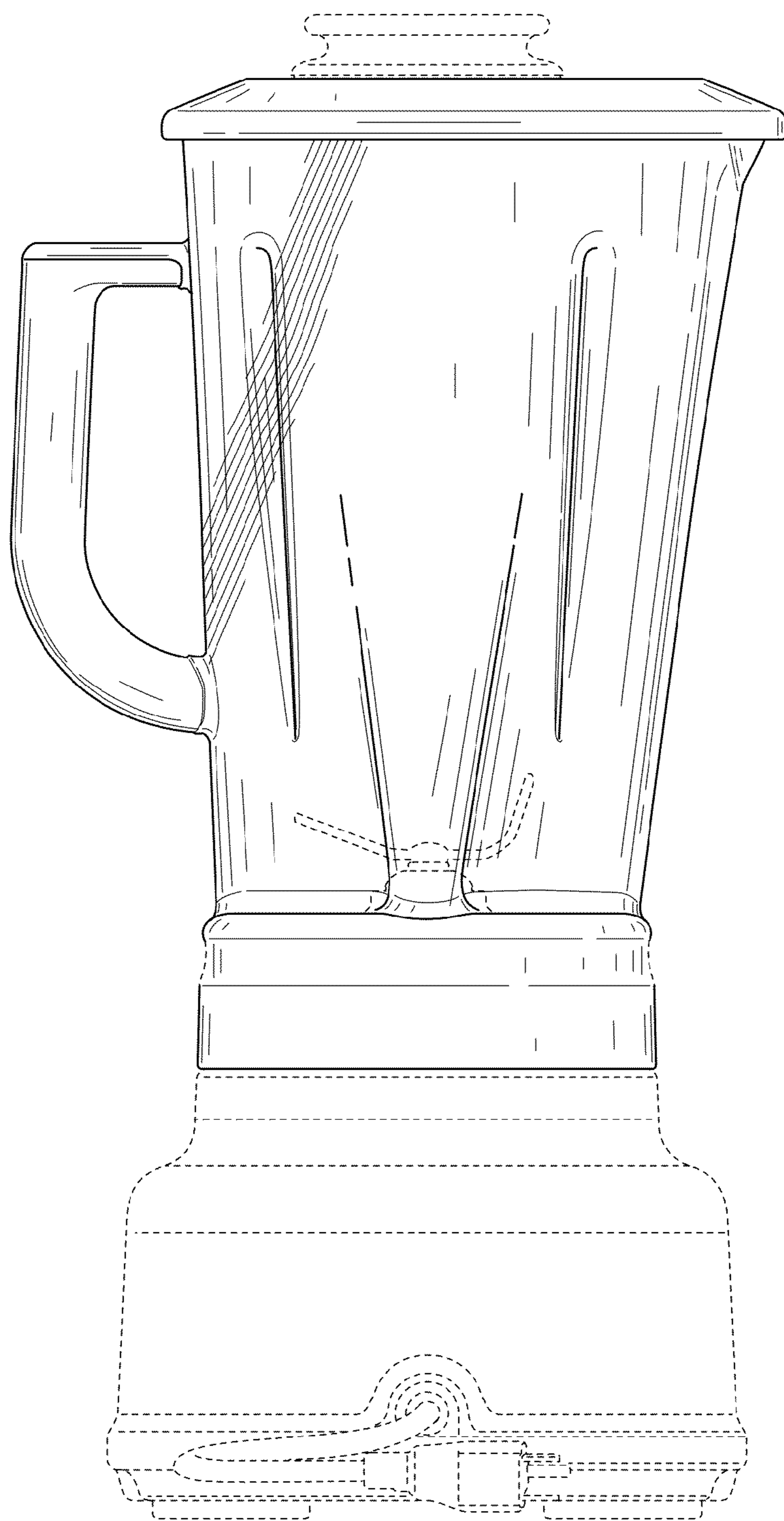

FIG. 1



**FIG. 2**



**FIG. 3**

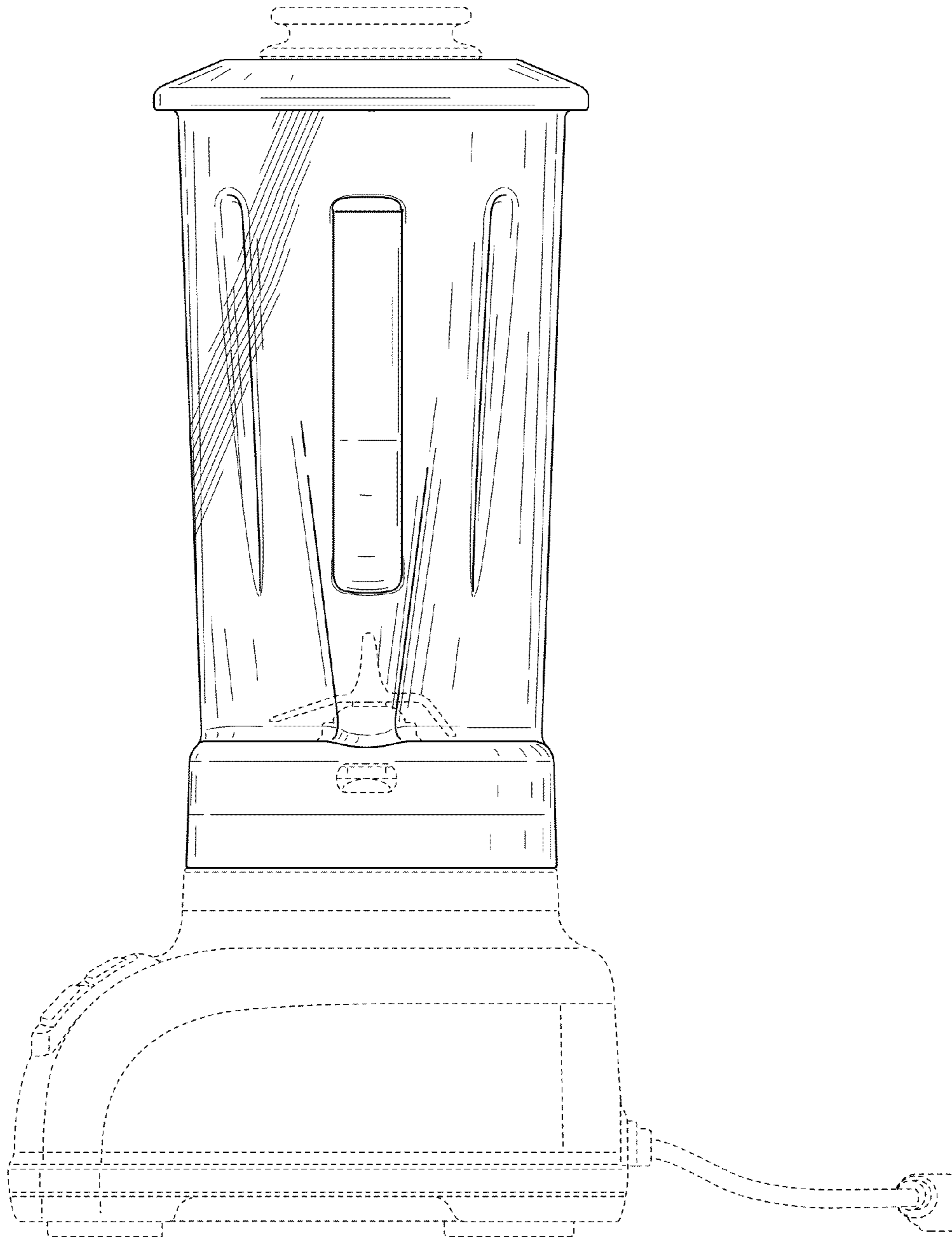
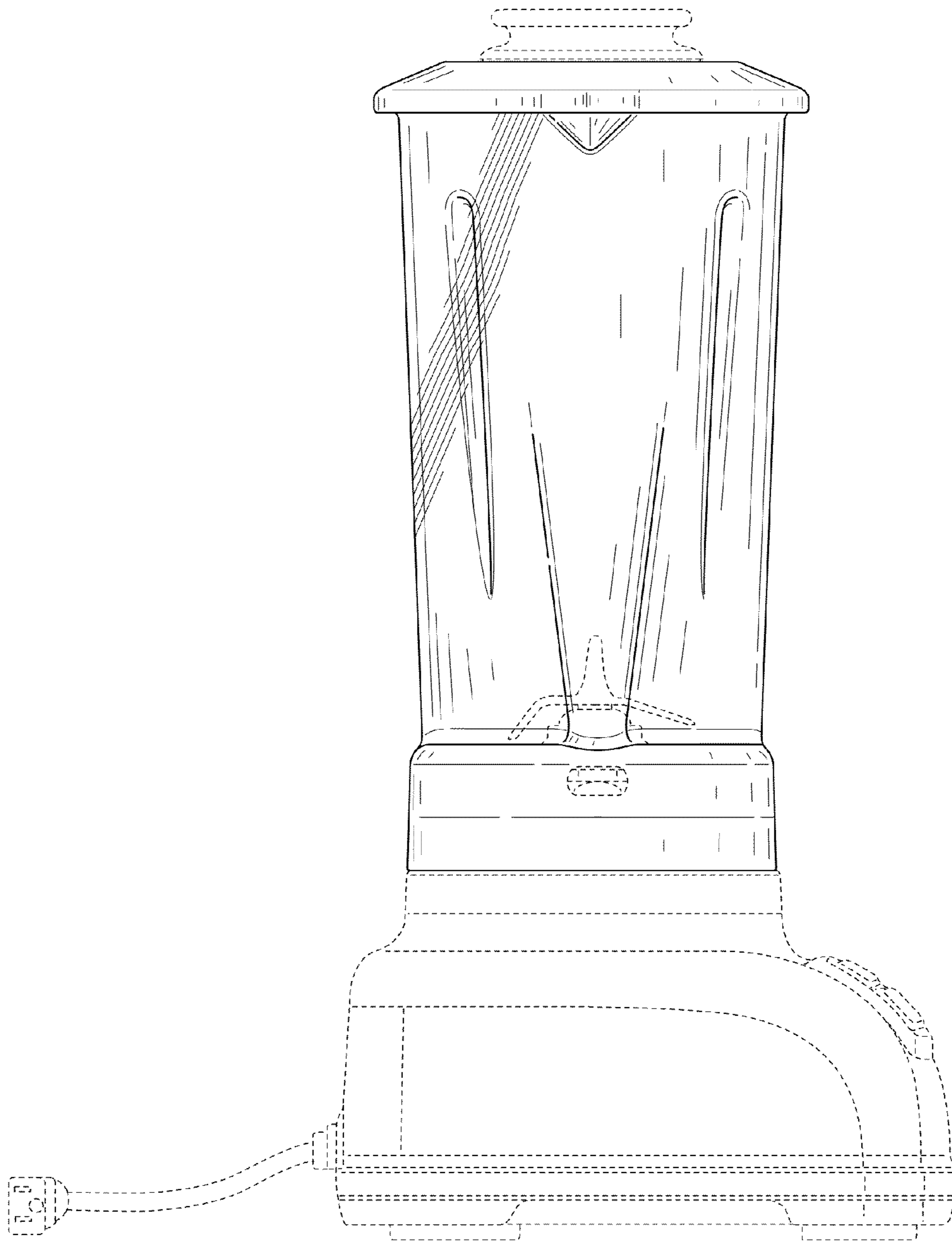
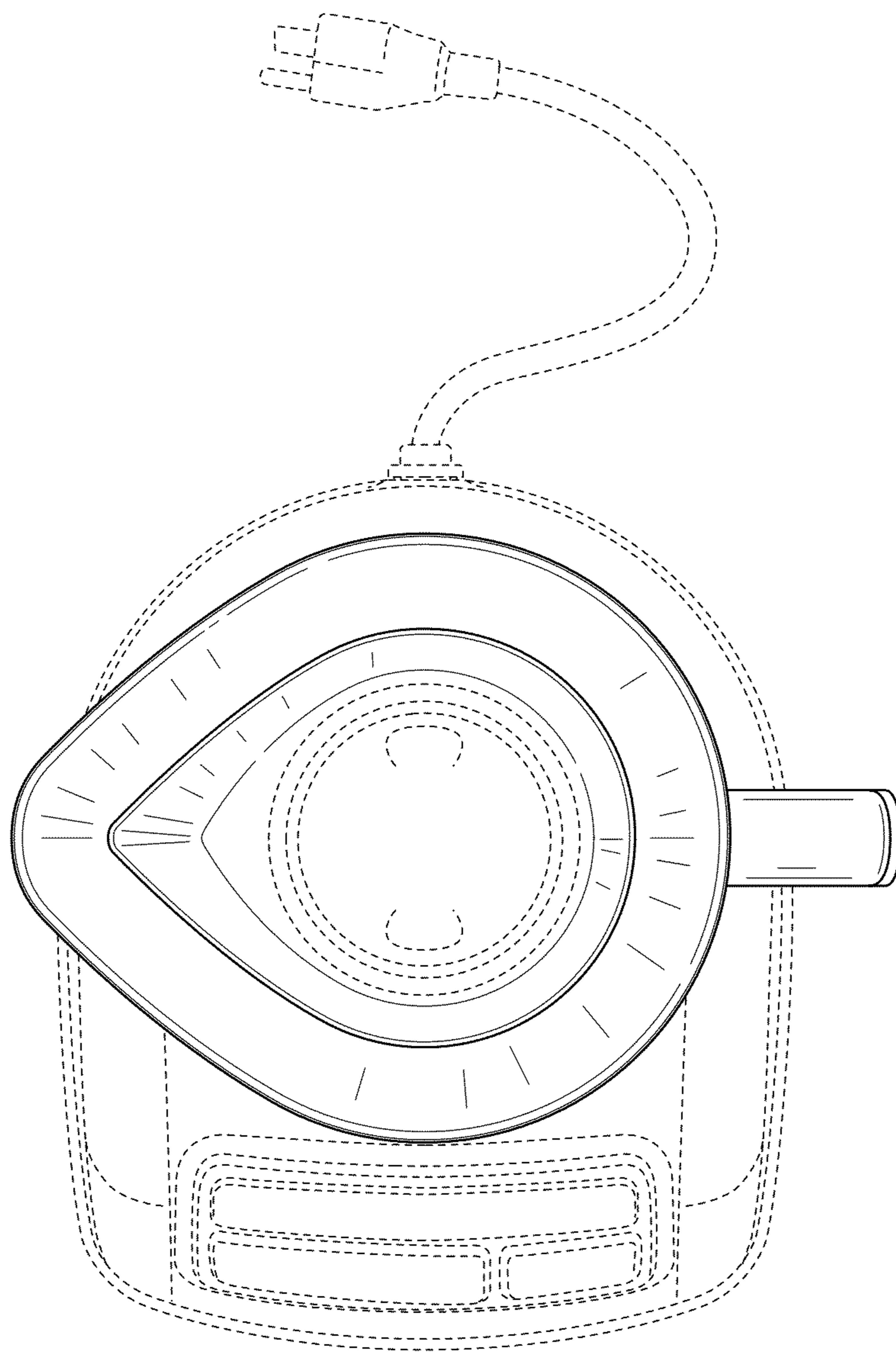

FIG. 4



**FIG. 5**



**FIG. 6**

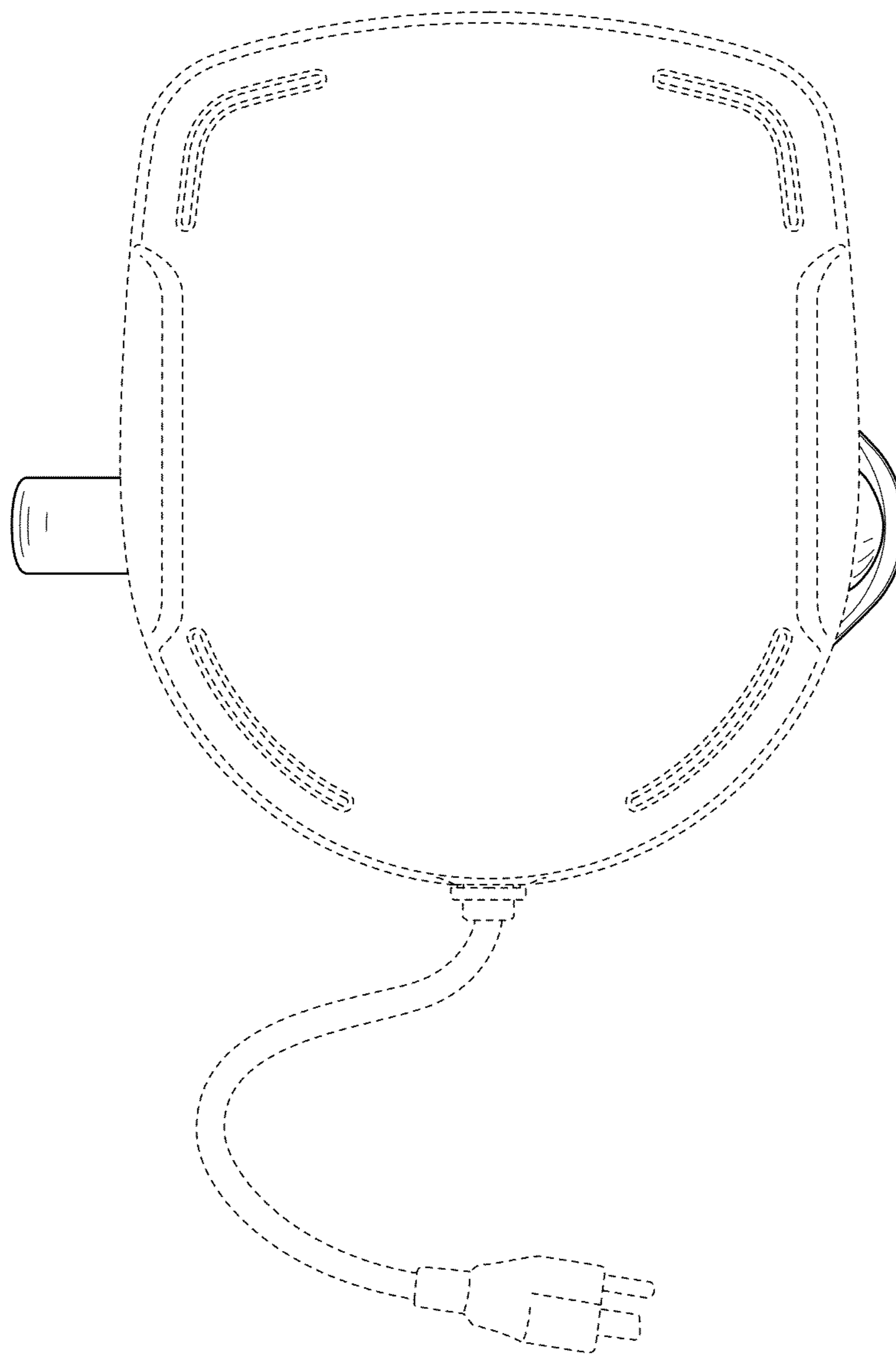

**FIG. 7**