



US00D694523S

(12) **United States Design Patent**
Chiang

(10) **Patent No.:** **US D694,523 S**

(45) **Date of Patent:** **** Dec. 3, 2013**

(54) **PROTECTIVE COVER**

(75) Inventor: **Meng-Sheng Chiang**, Taoyuan County (TW)

(73) Assignee: **HTC Corporation**, Taoyuan County (TW)

(**) Term: **14 Years**

(21) Appl. No.: **29/416,513**

(22) Filed: **Mar. 23, 2012**

(51) **LOC (9) Cl.** **03-01**

(52) **U.S. Cl.**
USPC **D3/303**

(58) **Field of Classification Search**

USPC D3/234, 255, 271.9, 320, 256, 262, 279, D3/299, 301, 303, 318, 319, 273, 289, 292, D3/294-296, 232, 244, 228; D9/424, 420; D27/189; 206/349; 220/833; 312/902; 190/100; D14/440; D19/35

See application file for complete search history.

(56) **References Cited**

U.S. PATENT DOCUMENTS

2,175,327 A * 10/1939 Thornhill et al. 150/129
5,445,251 A * 8/1995 Redwood 190/109

(Continued)

FOREIGN PATENT DOCUMENTS

JP D1416392 6/2011
TW D150510 12/2012

OTHER PUBLICATIONS

“Office Action of Taiwan counterpart application No. 101303131” issued on Jan. 10, 2013, p. 1-p. 3.

(Continued)

Primary Examiner — Sandra Snapp

(74) *Attorney, Agent, or Firm* — Jianq Chyun IP Office

(57) **CLAIM**

The ornamental design for a protective cover, as shown and described.

DESCRIPTION

FIG. 1 is a perspective view of a protective cover showing a first embodiment of my new design;
FIG. 2 is a front view of the first embodiment;
FIG. 3 is a rear view of the first embodiment;
FIG. 4 is a left side view of the first embodiment;
FIG. 5 is a right side view of the first embodiment;
FIG. 6 is a top view of the first embodiment;
FIG. 7 is a bottom view of the first embodiment;
FIG. 8 is a front view of the first embodiment, shown in unfolded condition;
FIG. 9 is a reference view of the first embodiment, shown in folded condition without a pen;
FIG. 10 is a reference view of the first embodiment, shown in folded condition with a pen;
FIG. 11 is a perspective view of a protective cover showing a second embodiment of my new design;
FIG. 12 is a front view of the second embodiment;
FIG. 13 is a rear view of the second embodiment;
FIG. 14 is a left side view of the second embodiment;
FIG. 15 is a right side view of the second embodiment;
FIG. 16 is a top view of the second embodiment;
FIG. 17 is a bottom view of the second embodiment;
FIG. 18 is a front view of the second embodiment, shown in unfolded condition;
FIG. 19 is a reference view of the second embodiment, shown in folded condition without a pen; and,
FIG. 20 is a reference view of the second embodiment, shown in folded condition with a pen.
The broken lines shown in the figures are for illustrative purposes only and do not form part of the claimed design.

1 Claim, 14 Drawing Sheets

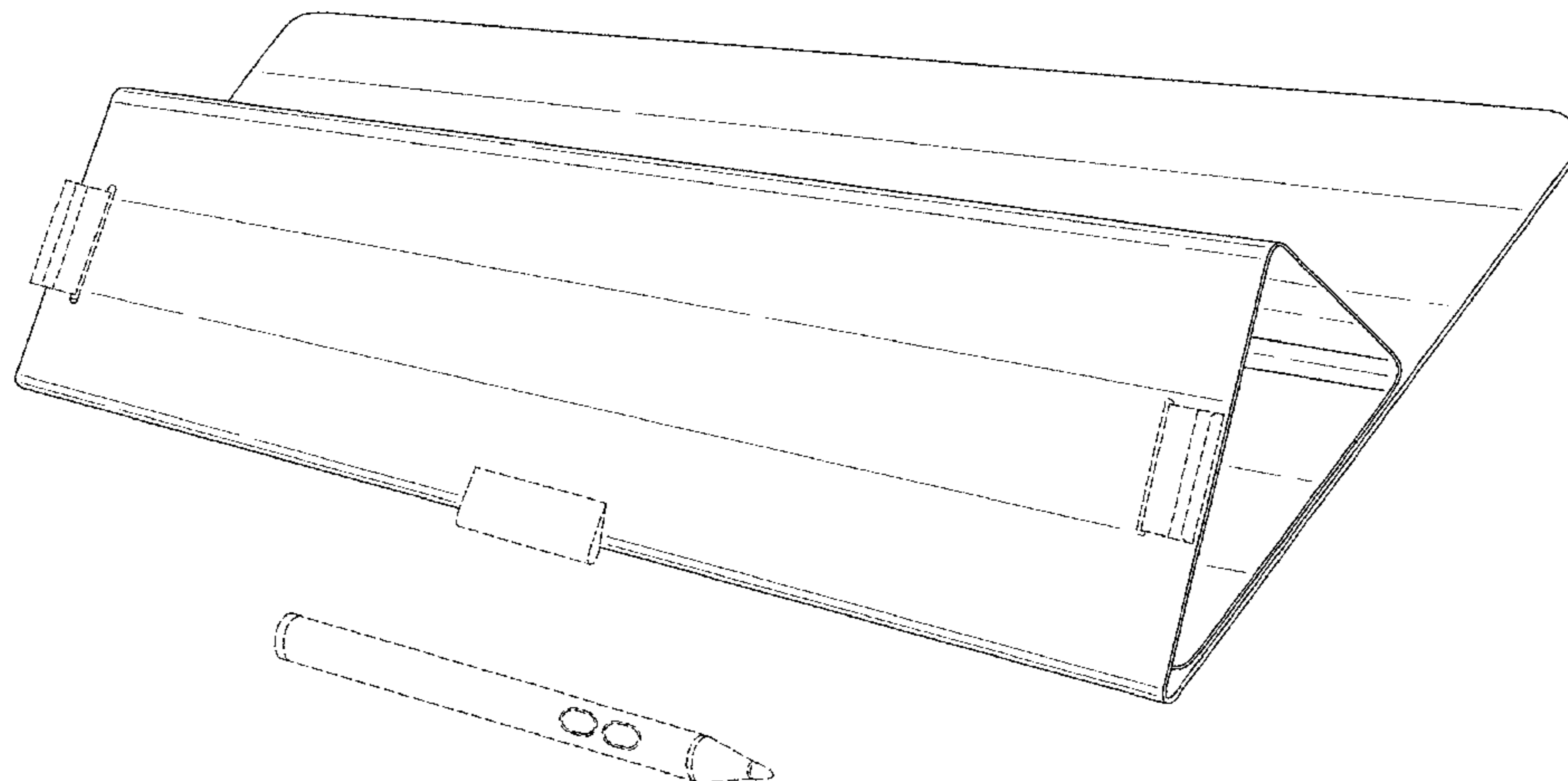

(56)

References Cited

U.S. PATENT DOCUMENTS

D496,792 S 10/2004 Crites
D544,922 S * 6/2007 Shaffer D20/10
D600,699 S * 9/2009 Johnston et al. D14/440
D607,035 S * 12/2009 Adams et al. D16/241
D658,187 S * 4/2012 Diebel D14/440
D658,188 S * 4/2012 Diebel D14/440
D660,592 S * 5/2012 Mecchella D3/299
D672,146 S * 12/2012 Fathollahi D3/299

8,328,008 B2 * 12/2012 Diebel et al. 206/45.24
D674,016 S * 1/2013 Letterle D19/35
D677,668 S * 3/2013 Phillips et al. D14/440
D685,803 S * 7/2013 Akana et al. D14/440
2009/0159763 A1 * 6/2009 Kim 248/174

OTHER PUBLICATIONS

“Office Action of Taiwan counterpart application No. 101303131U01” issued on Jan. 10, 2013, p. 1-p. 3.

* cited by examiner

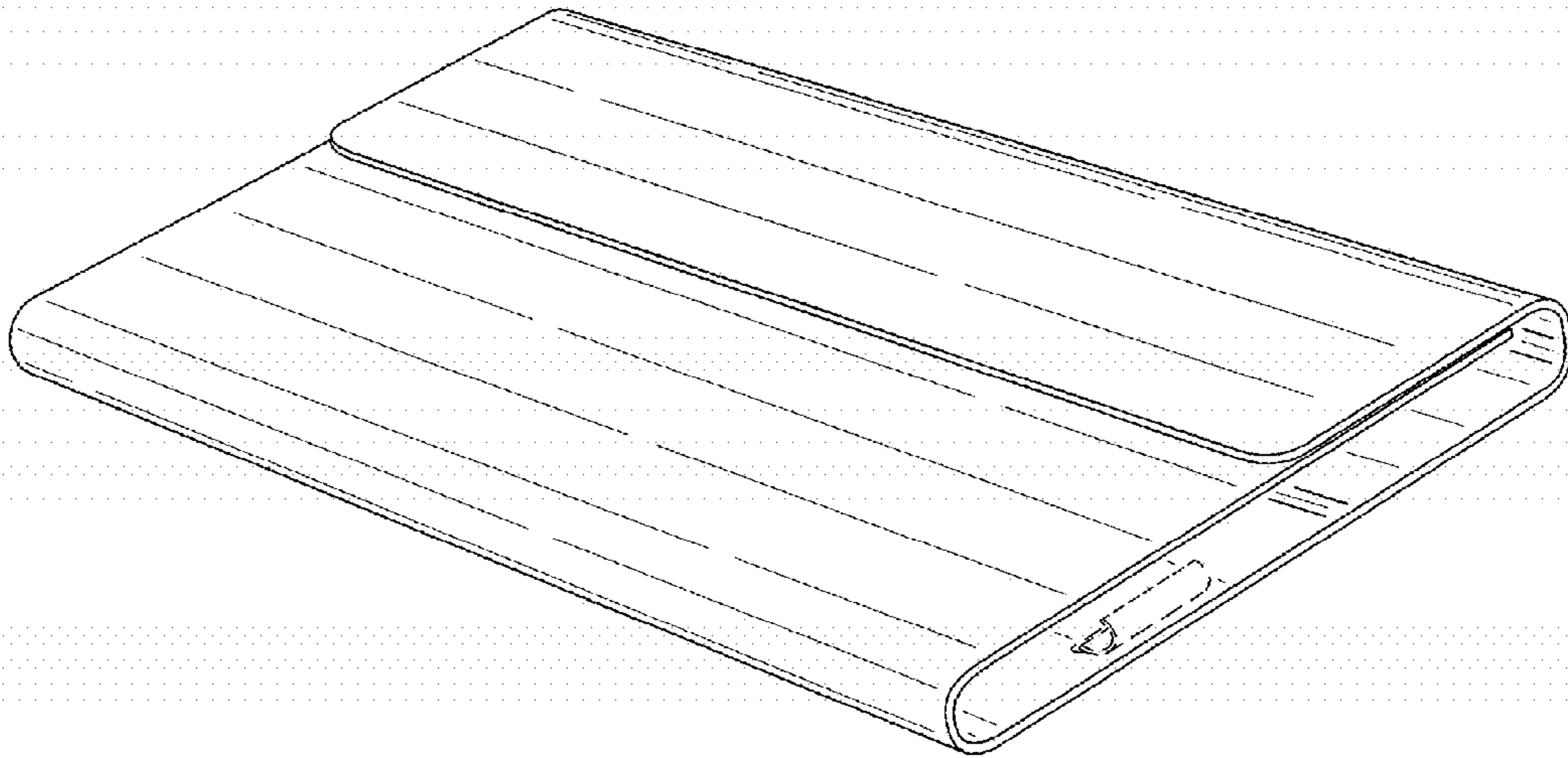

FIG. 1

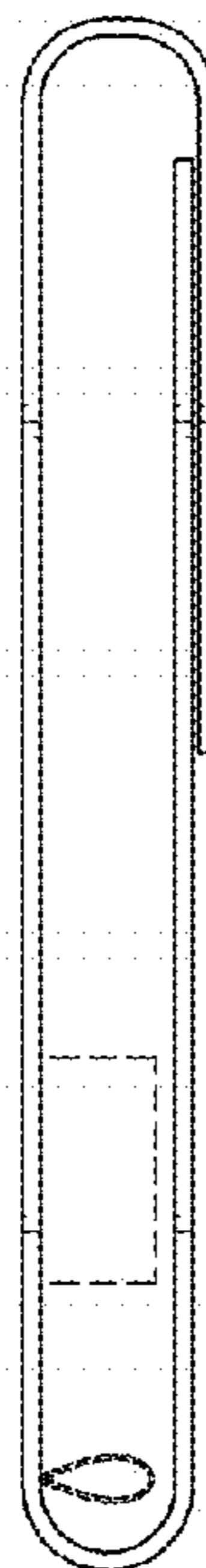

FIG. 4

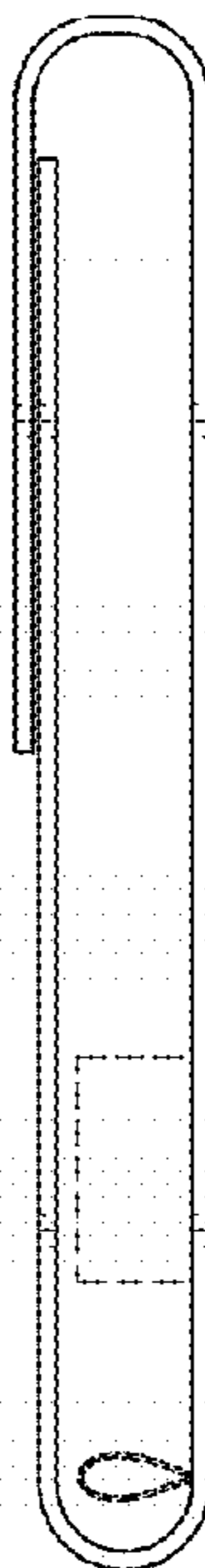

FIG. 5

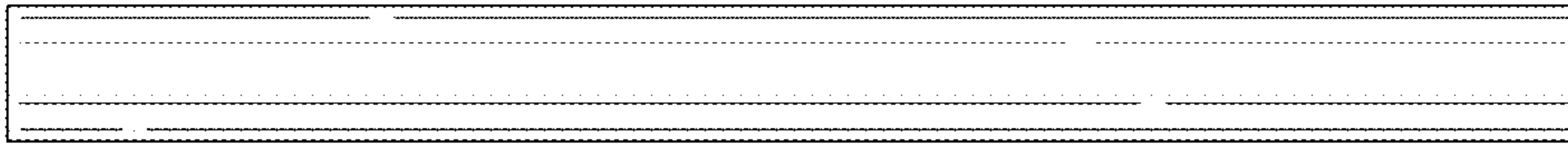

FIG. 6

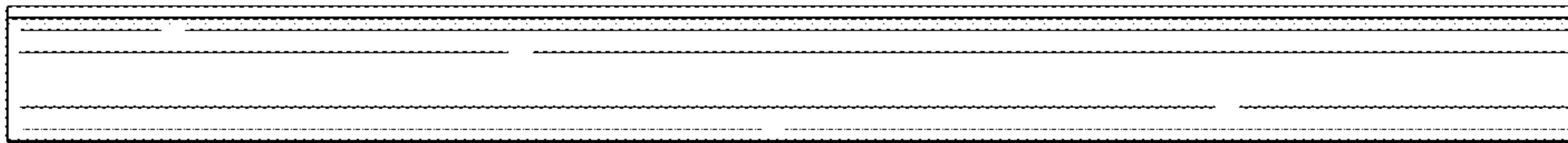

FIG. 7

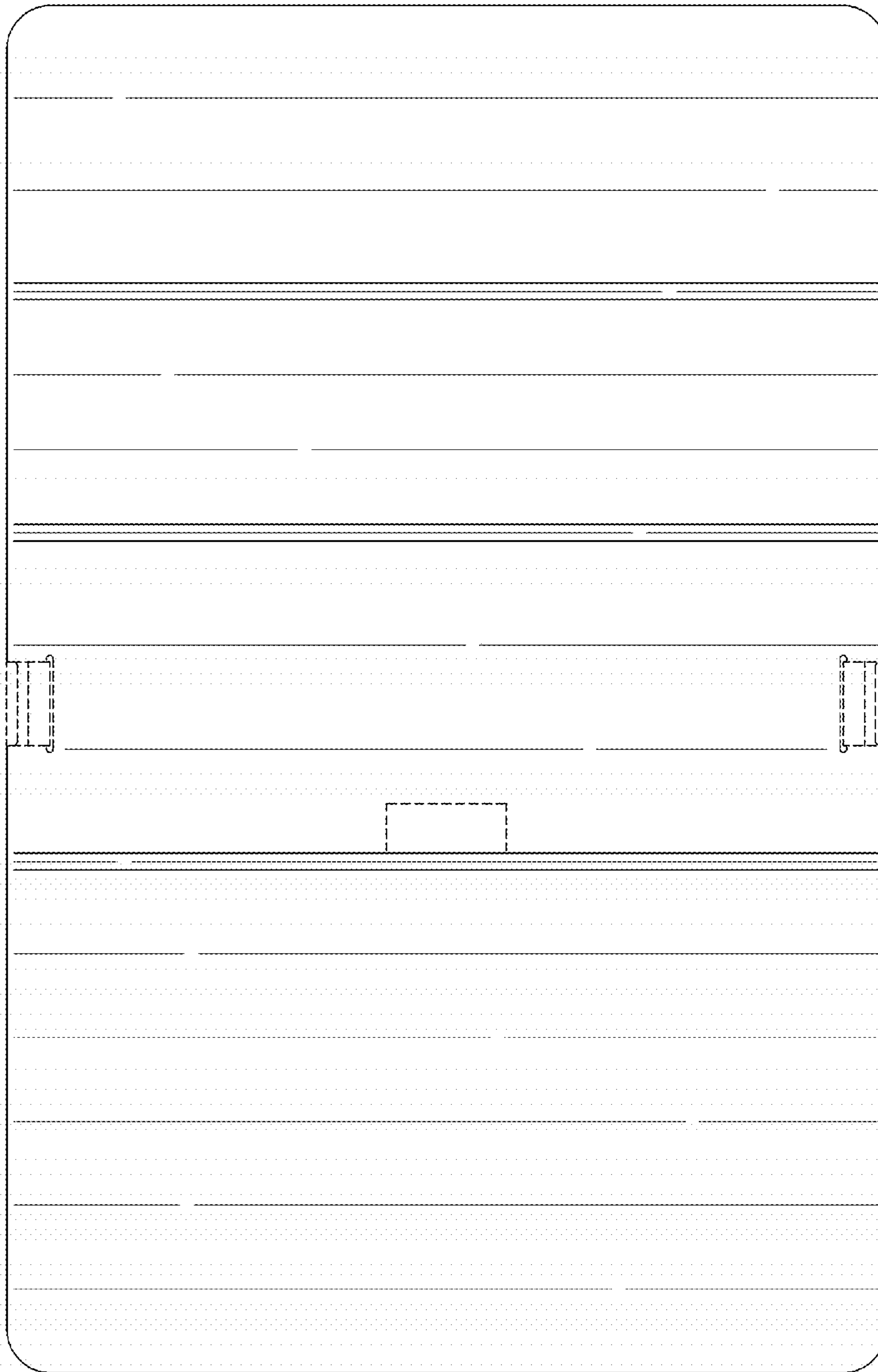

FIG. 8

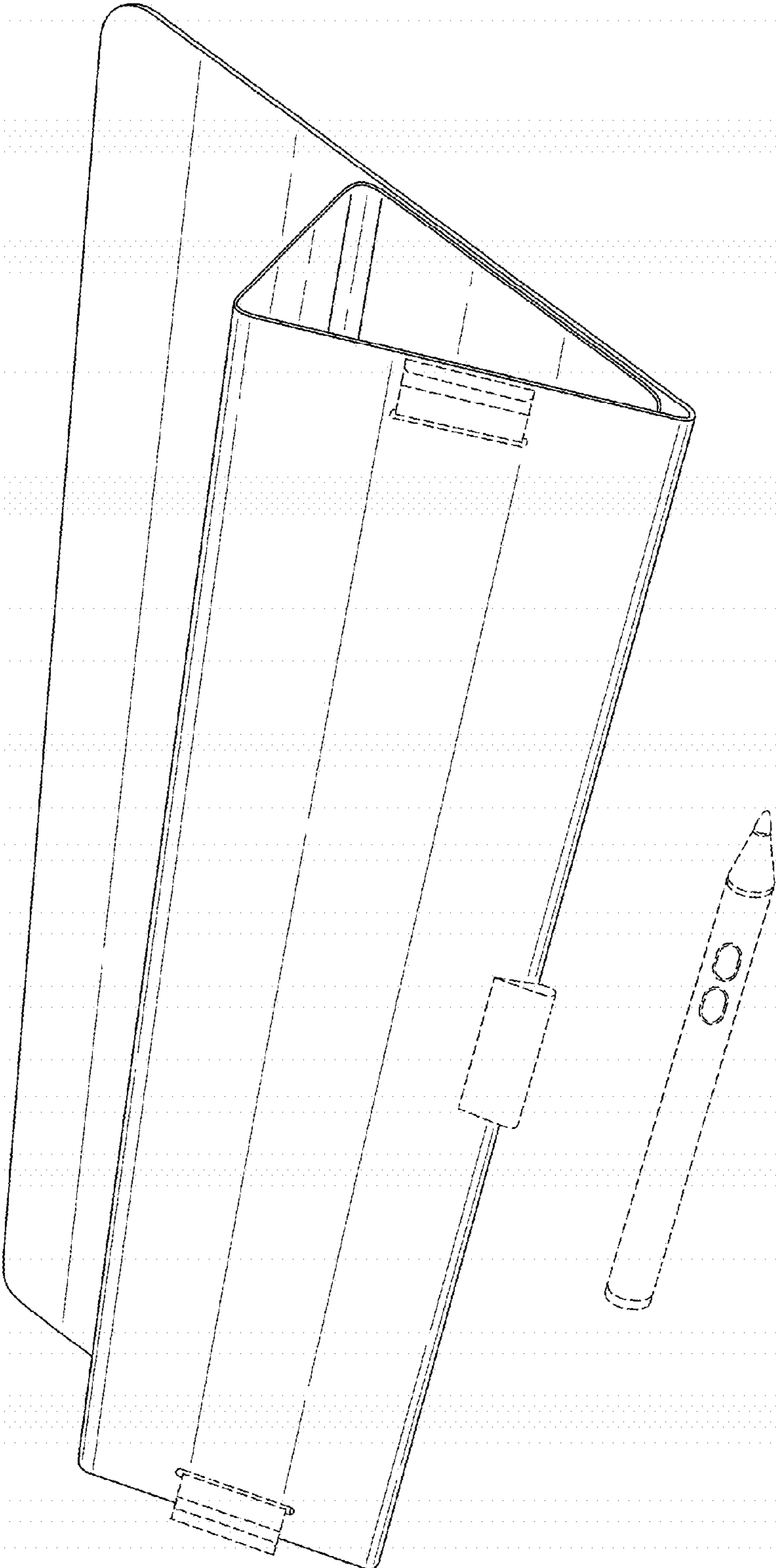

FIG. 9



FIG. 10

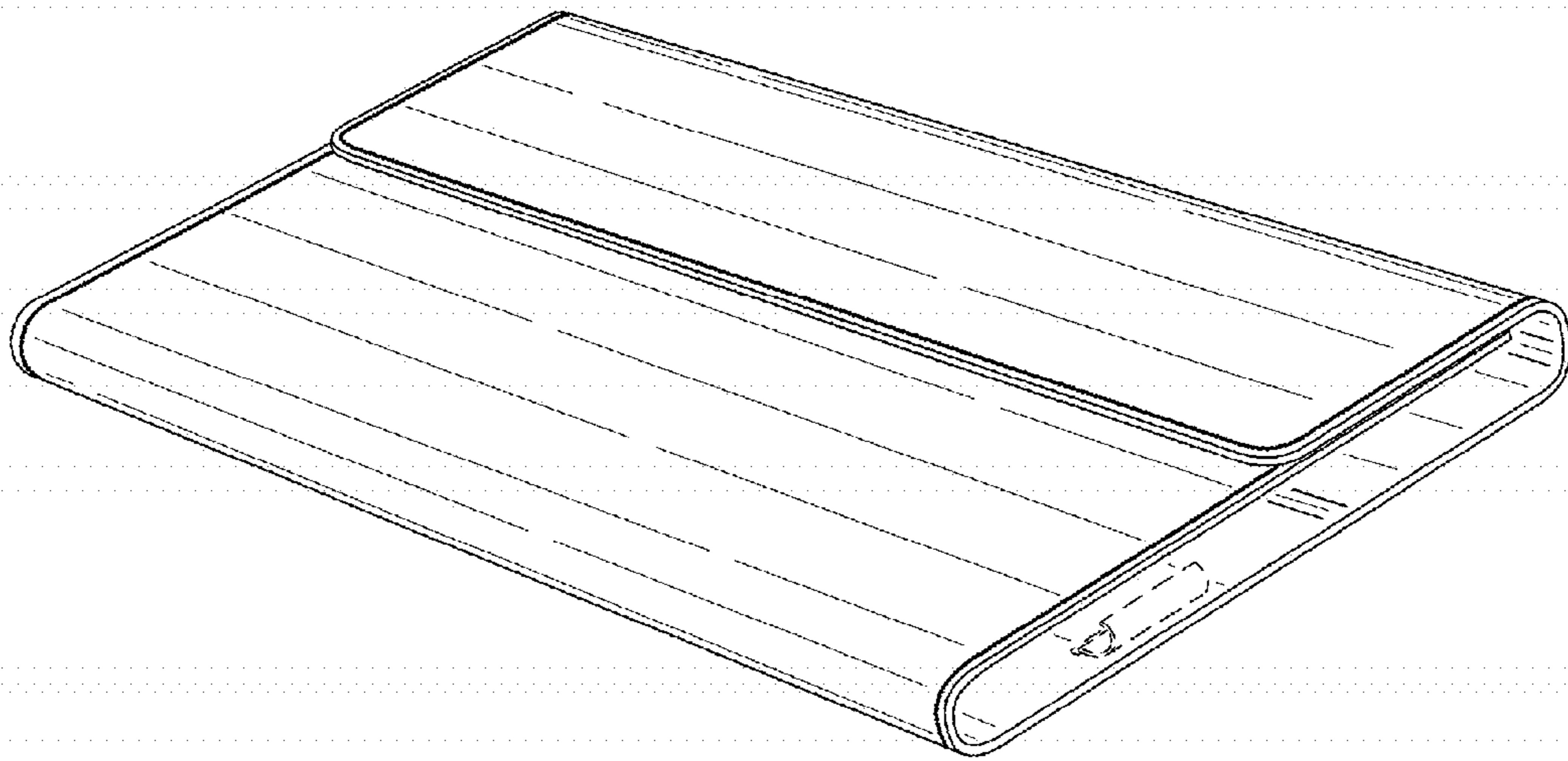

FIG. 11

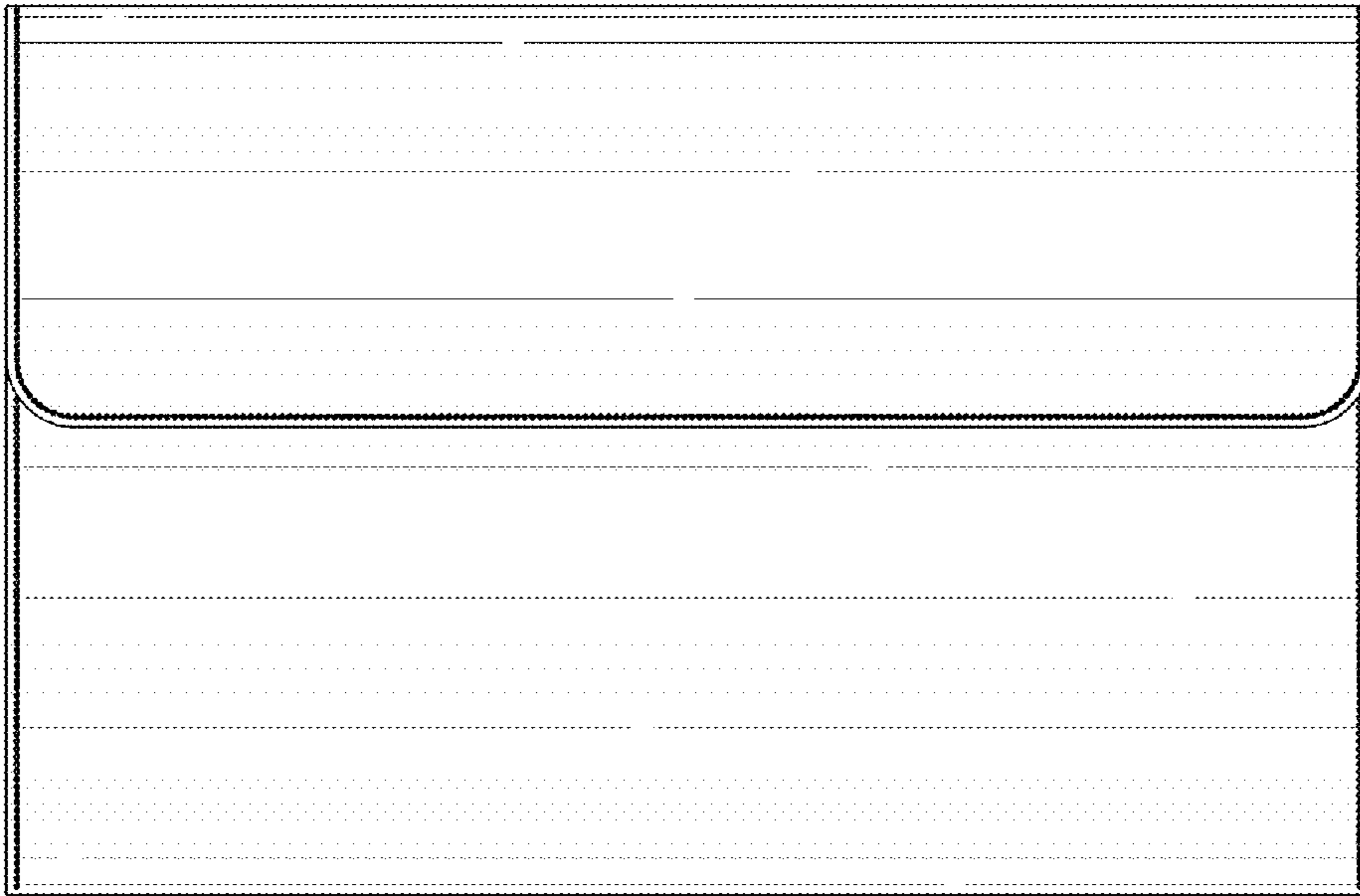

FIG. 12

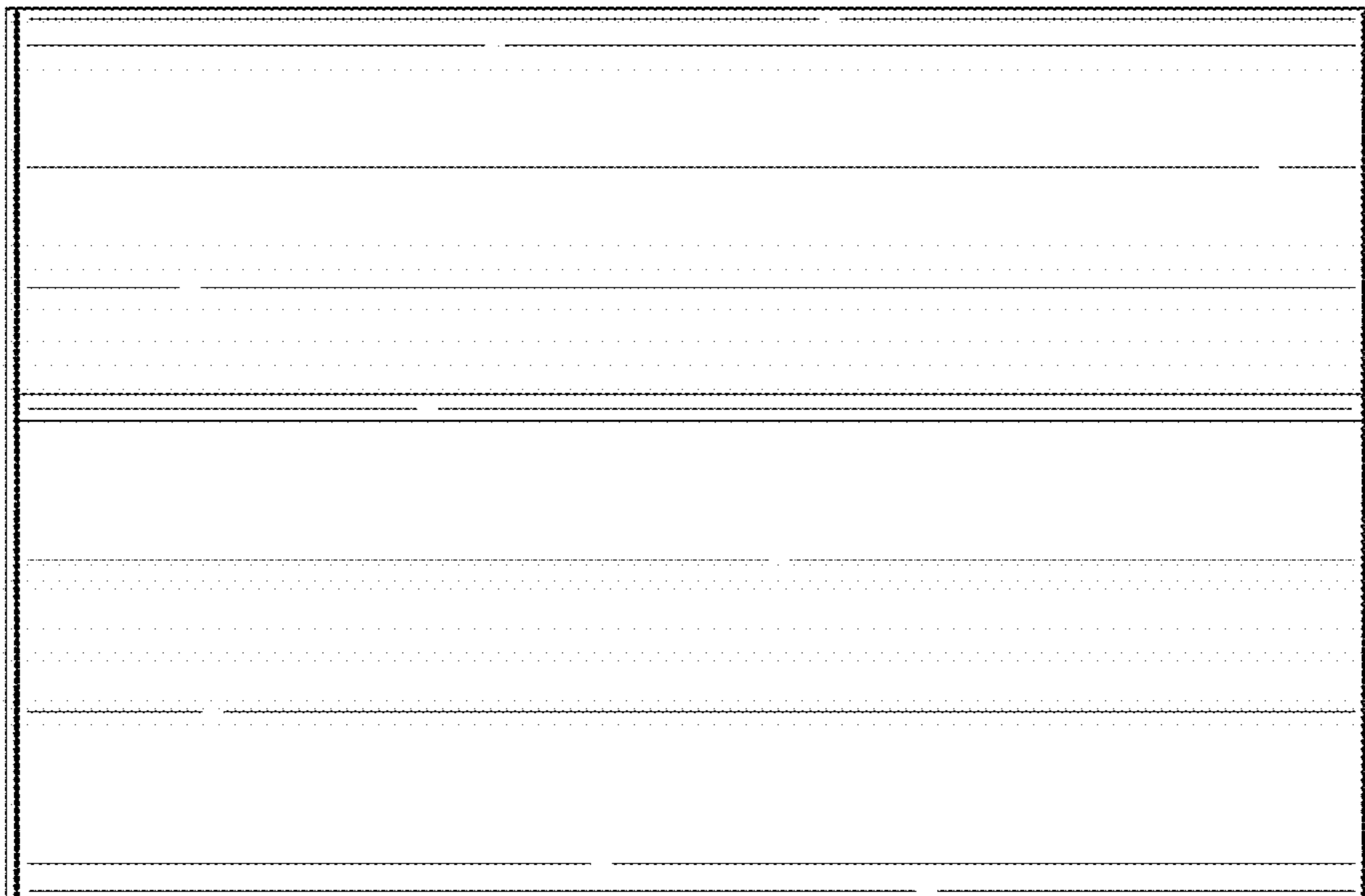

FIG. 13

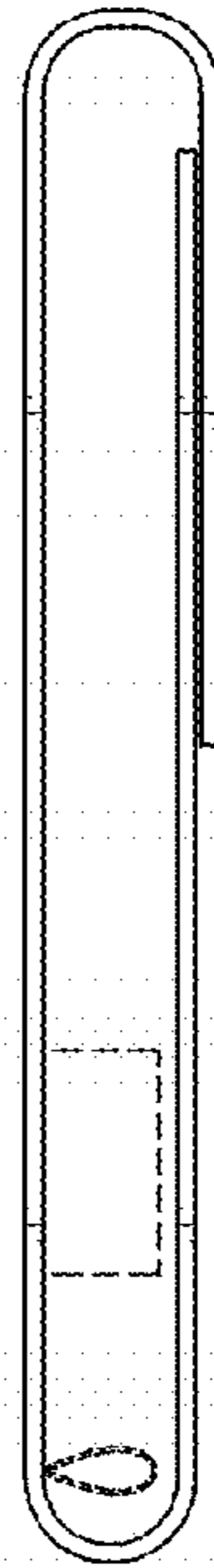

FIG. 14

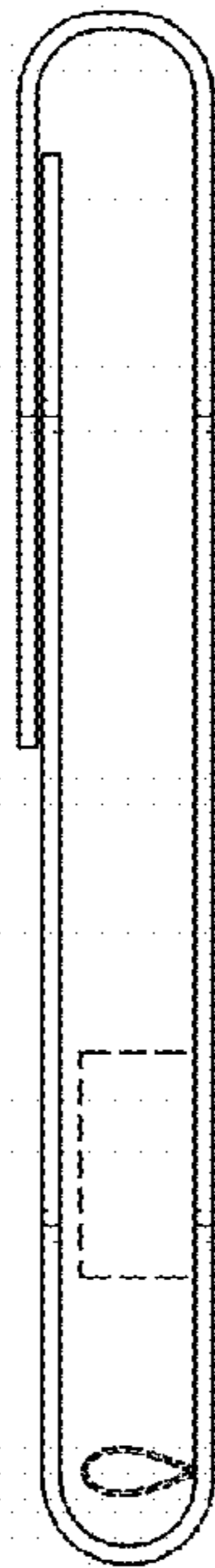

FIG. 15

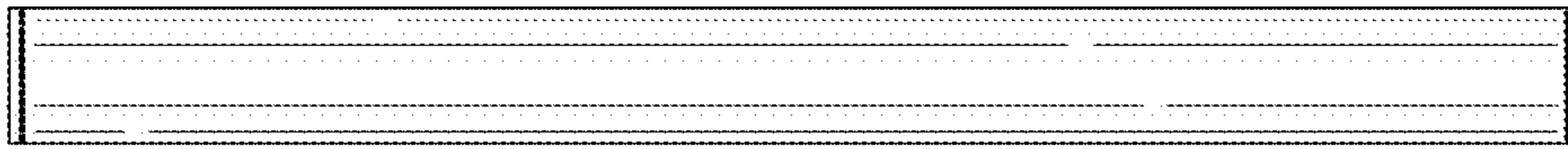

FIG. 16

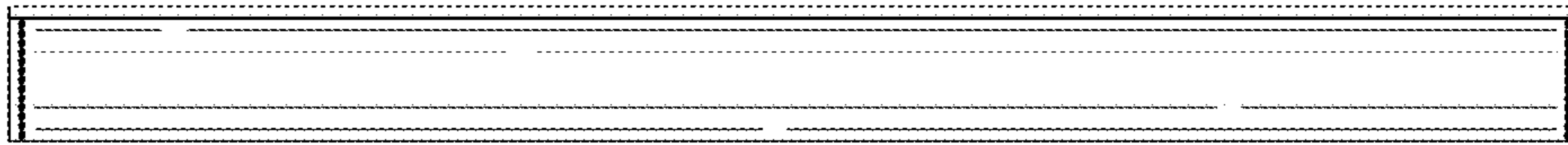

FIG. 17

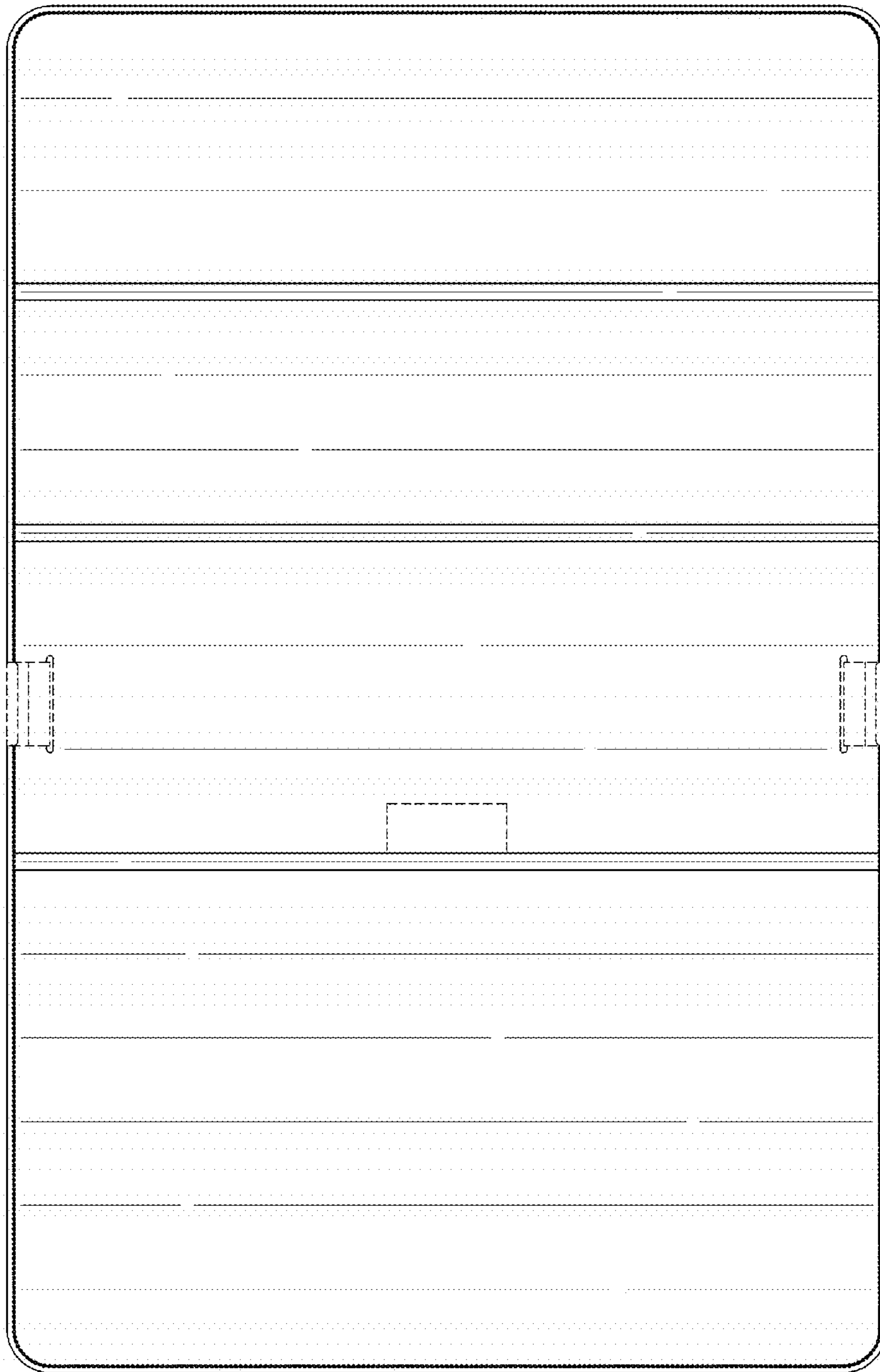

FIG. 18

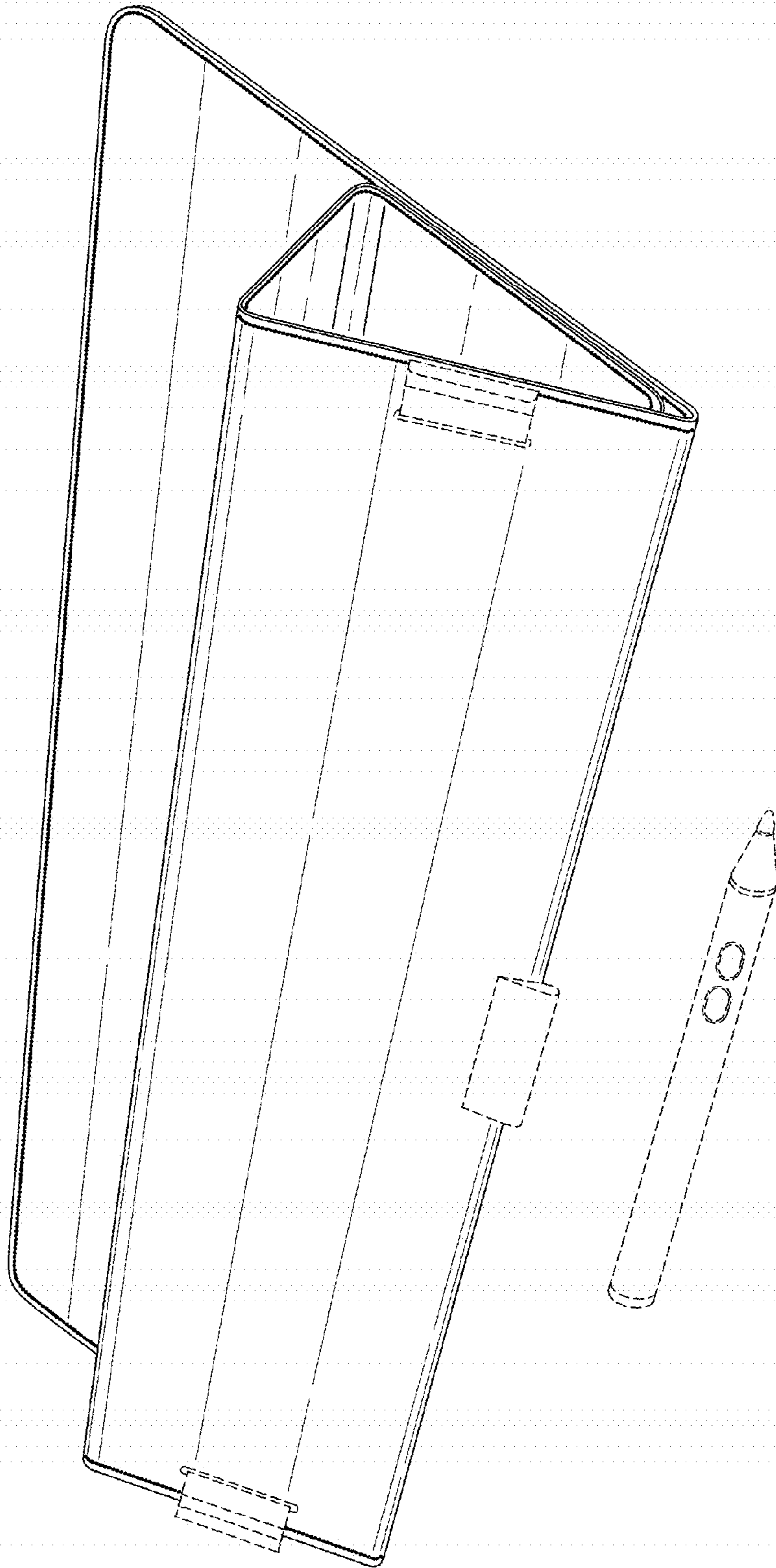

FIG. 19

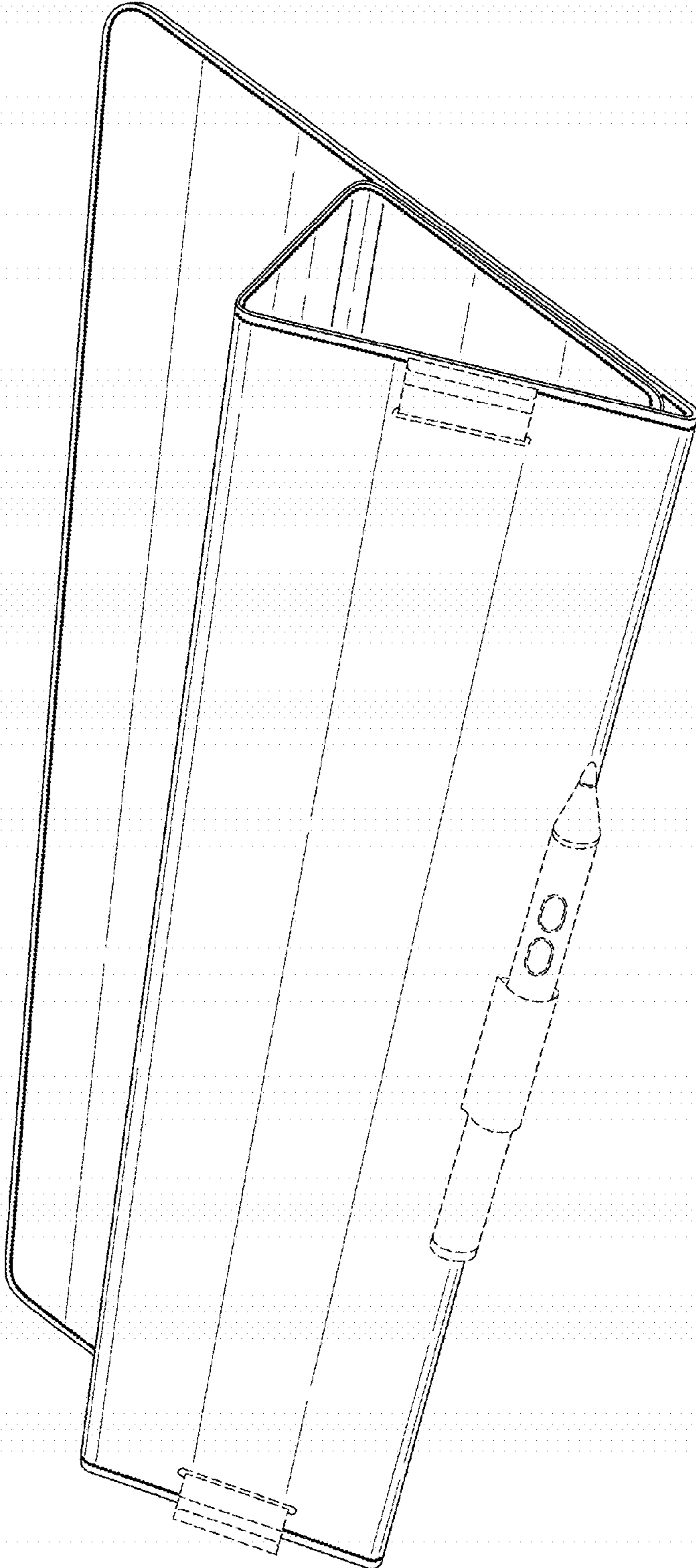

FIG. 20