

US00D694494S

(12) **United States Design Patent**
Jacquart Thorsen et al.

(10) **Patent No.:** **US D694,494 S**

(45) **Date of Patent:** **** *Dec. 3, 2013**

(54) **HAT WITH OFFSET BADGE**

(71) Applicant: **Jacquart Fabric Products, Inc.**,
Ironwood, MI (US)

(72) Inventors: **Gina Jacquart Thorsen**, Mercer, WI
(US); **David J. Thorsen**, Mercer, WI
(US)

(73) Assignee: **Jacquart Fabric Products, Inc.**,
Ironwood, MI (US)

(*) Notice: This patent is subject to a terminal disclaimer.

(**) Term: **14 Years**

(21) Appl. No.: **29/447,866**

(22) Filed: **Mar. 7, 2013**

(51) **LOC (9) Cl.** **02-03**

(52) **U.S. Cl.**
USPC **D2/882**

(58) **Field of Classification Search**
USPC D2/865, 866, 878, 879, 880, 881, 882,
D2/883, 884, 886, 891, 892, 893, 894,
D2/895; D11/95; D20/19, 27; 2/10, 12, 68,
2/171, 175.1, 175.2, 175.3, 183, 195.1,
2/195.2, 195.3, 195.4, 195.5, 195.6,
2/200.1, 200.2, 209.11, 209.12, 209.13,
2/209.7, 244; 24/305, 620; 40/1.5, 329,
40/662, 663

See application file for complete search history.

(56) **References Cited**

U.S. PATENT DOCUMENTS

166,395 A * 8/1875 Marks 2/172
192,253 A * 6/1877 Girbardt 2/172

RE7,807 E * 7/1877 Marks 2/172
799,997 A * 9/1905 MacLellan 40/662
1,056,391 A * 3/1913 Baldwin 2/204
1,274,652 A 8/1918 Winglet
1,328,823 A * 1/1920 De Sibour 40/329
D58,303 S 7/1921 Bartholomew
1,435,221 A * 11/1922 Fischer 2/195.4
1,540,405 A 6/1925 Kromer
D68,095 S 9/1925 Finkelstein
1,616,475 A 2/1927 Tracey
D92,932 S 7/1934 Schaffer
2,133,619 A * 10/1938 Hutton 2/172
2,417,323 A 3/1947 Richards et al.
D187,519 S 3/1960 Lasting
3,097,363 A * 7/1963 LeBlanc 2/209.7
4,097,934 A * 7/1978 Weinstein 2/195.1
5,075,898 A * 12/1991 Bedient 2/10

(Continued)

Primary Examiner — Karen E Eldridge Powers

(74) *Attorney, Agent, or Firm* — Andrus, Scales, Starke & Sawall, LLP

(57) **CLAIM**

The ornamental design for a hat with an offset badge, as shown and described.

DESCRIPTION

FIG. 1 is an isometric view of a hat with a badge;
FIG. 2 is a right side elevation view of the hat with badge;
FIG. 3 is a front elevation view of the hat with badge;
FIG. 4 is a left side elevation view of the hat with badge;
FIG. 5 is a back elevation view of the hat with badge;
FIG. 6 is a top plan view of the hat with badge; and,
FIG. 7 is a bottom plan view of the hat with badge.
The letters SK shown in broken lines in the Figures are unclaimed features of the article to which the design is applied.

1 Claim, 4 Drawing Sheets

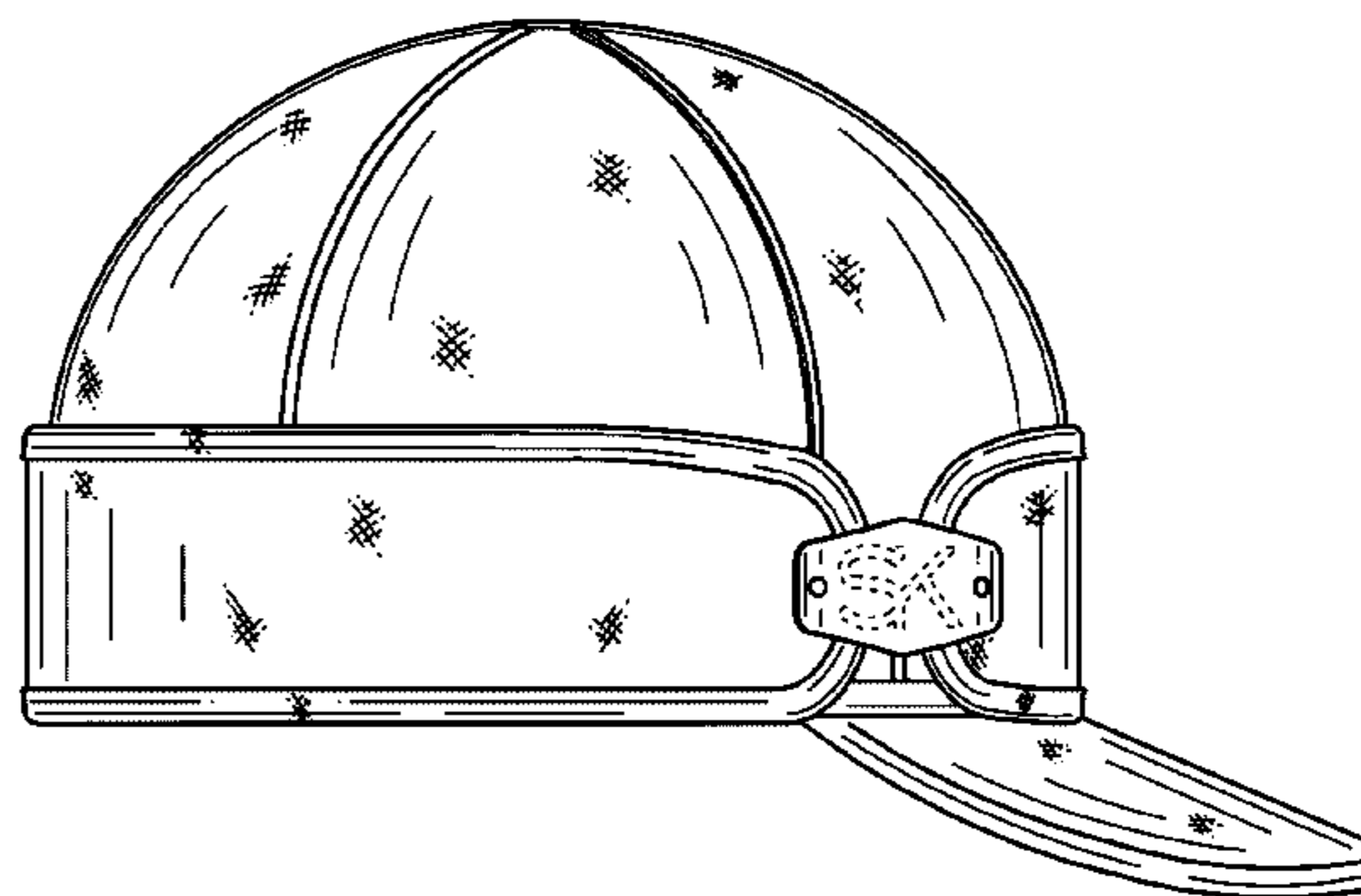
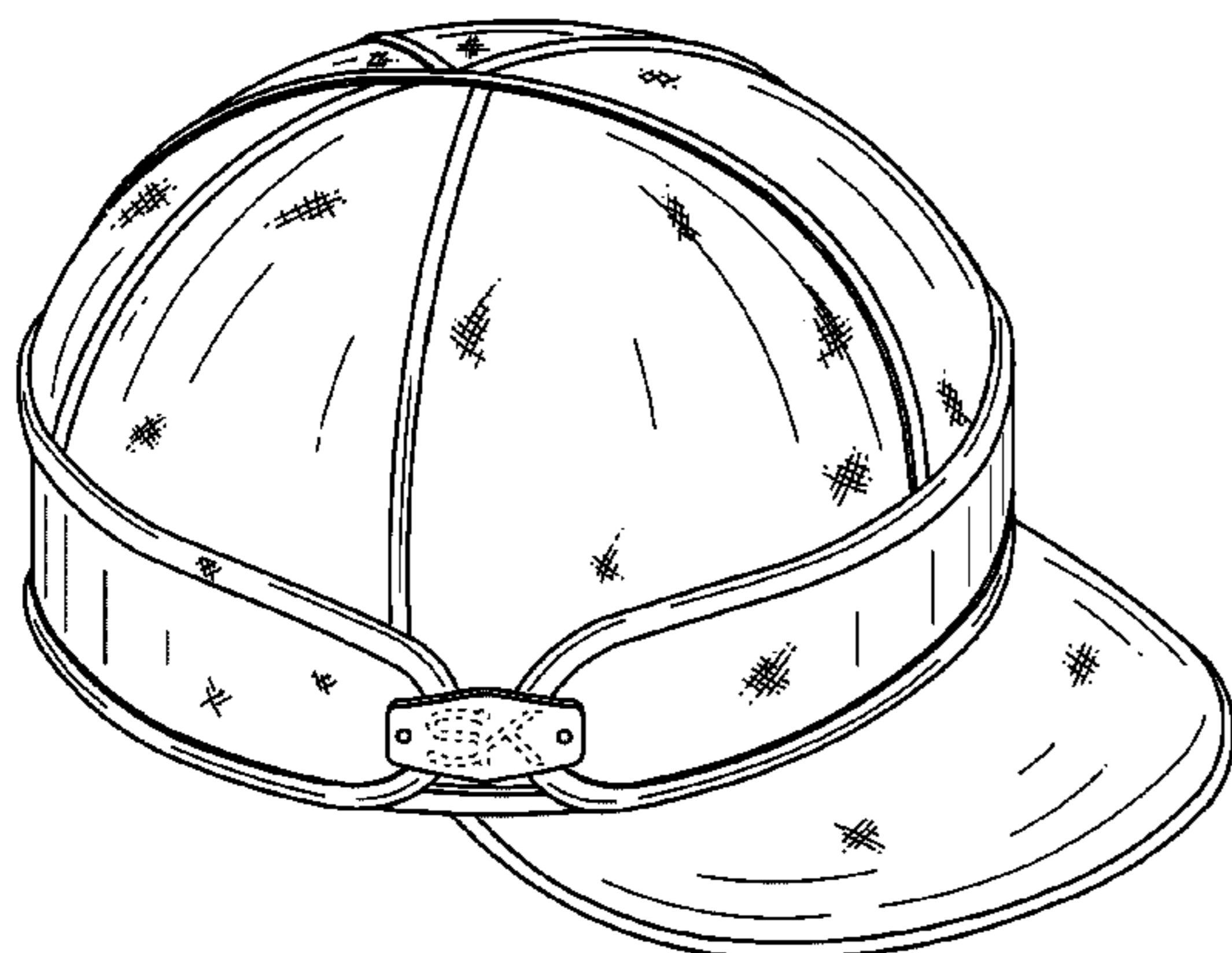

(56)

References Cited

U.S. PATENT DOCUMENTS

D405,239 S *	2/1999	Kostinko	D2/882	D543,014 S *	5/2007	Sharpe et al.	D2/884
D473,039 S	4/2003	Erspamer		7,322,050 B2 *	1/2008	Heatherly	2/244
D510,471 S *	10/2005	Yan	D2/882	D564,183 S	3/2008	Roach et al.	
7,203,971 B2 *	4/2007	Claro	2/195.2	D659,351 S	5/2012	Benkendorfer	
				D672,939 S	12/2012	Jacquart et al.	
				2008/0109940 A1 *	5/2008	Van Den Heuvel et al. .	2/209.12
				2008/0163405 A1 *	7/2008	Jacquart et al.	2/172

* cited by examiner

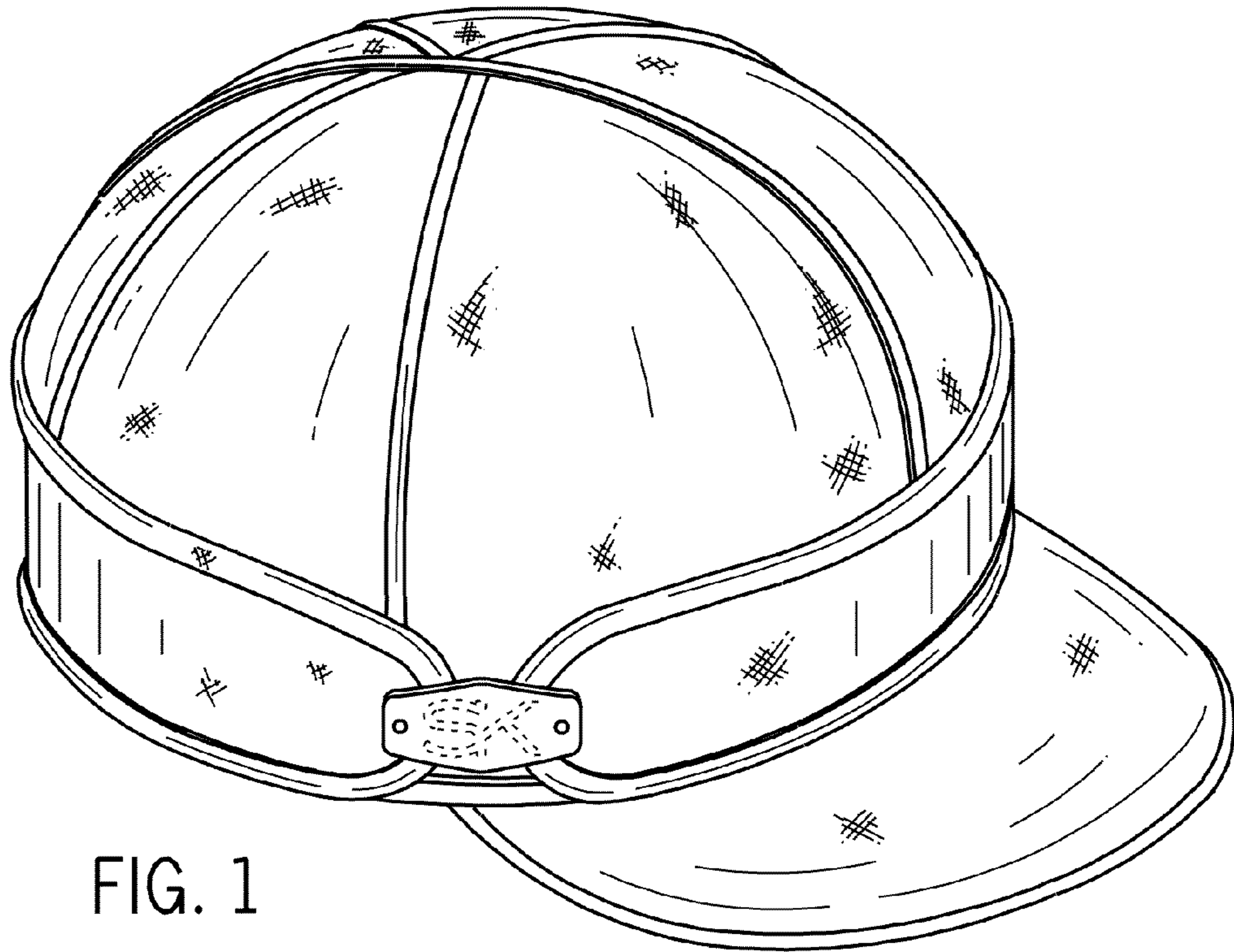

FIG. 1

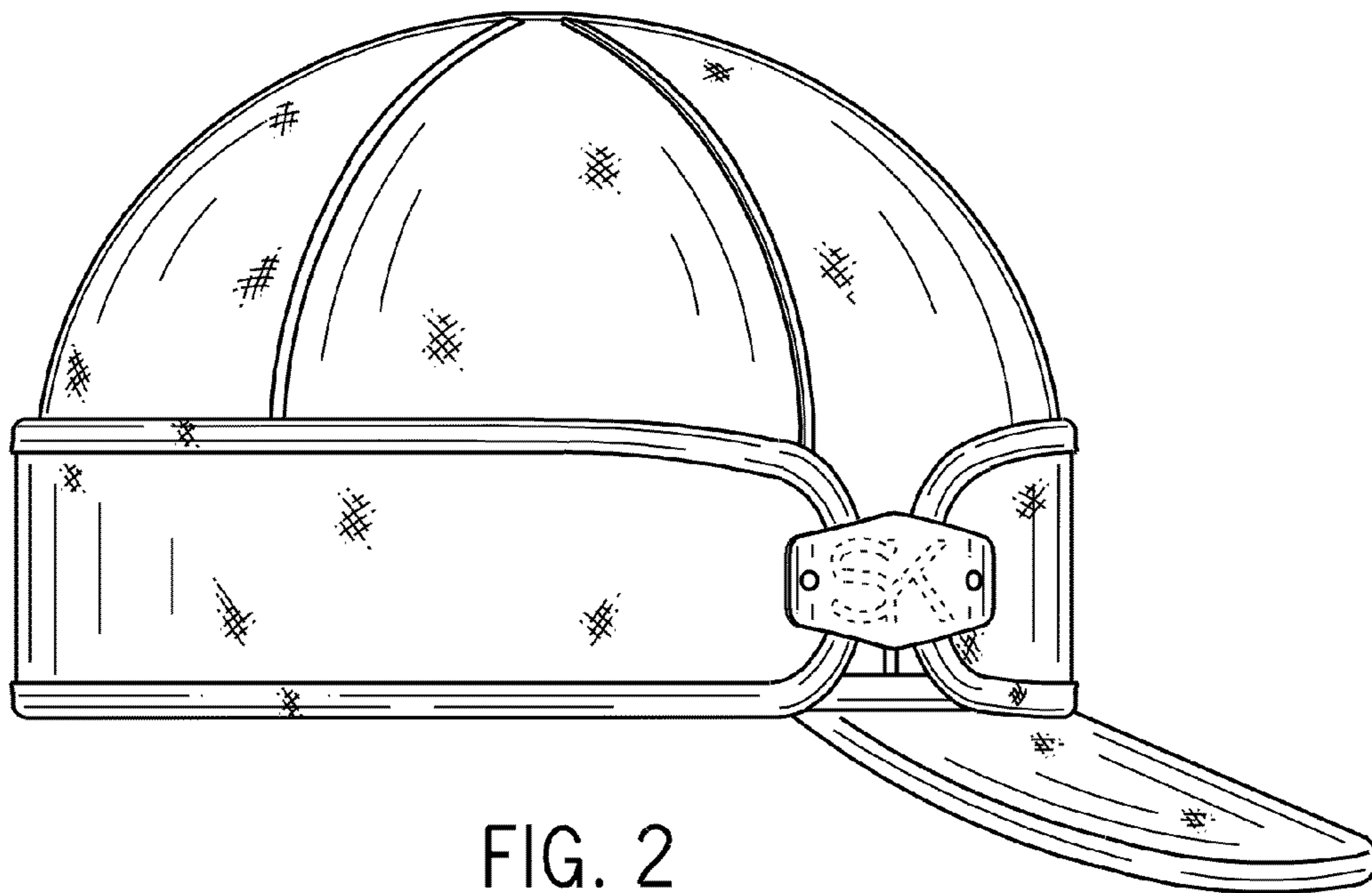

FIG. 2

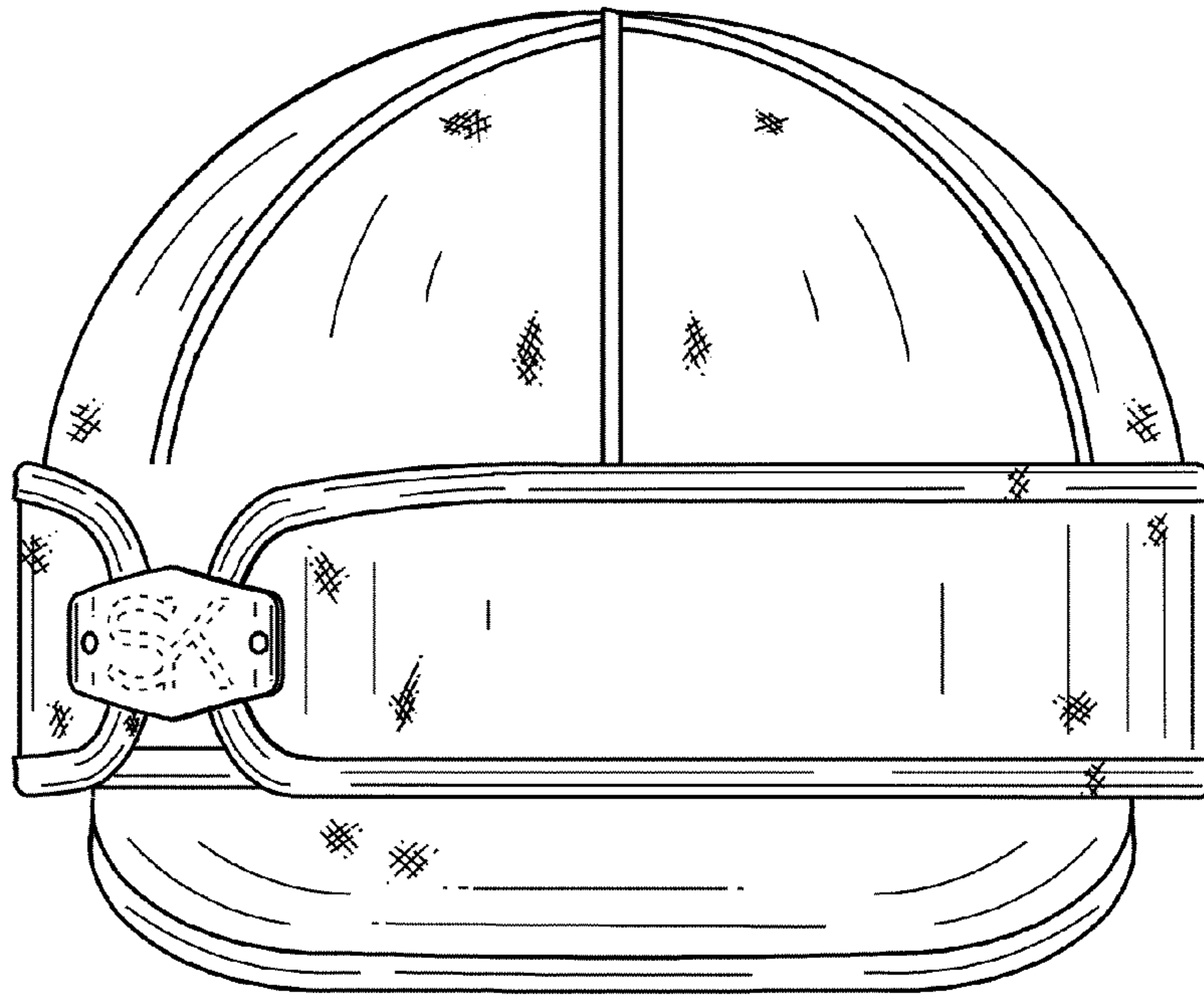

FIG. 3

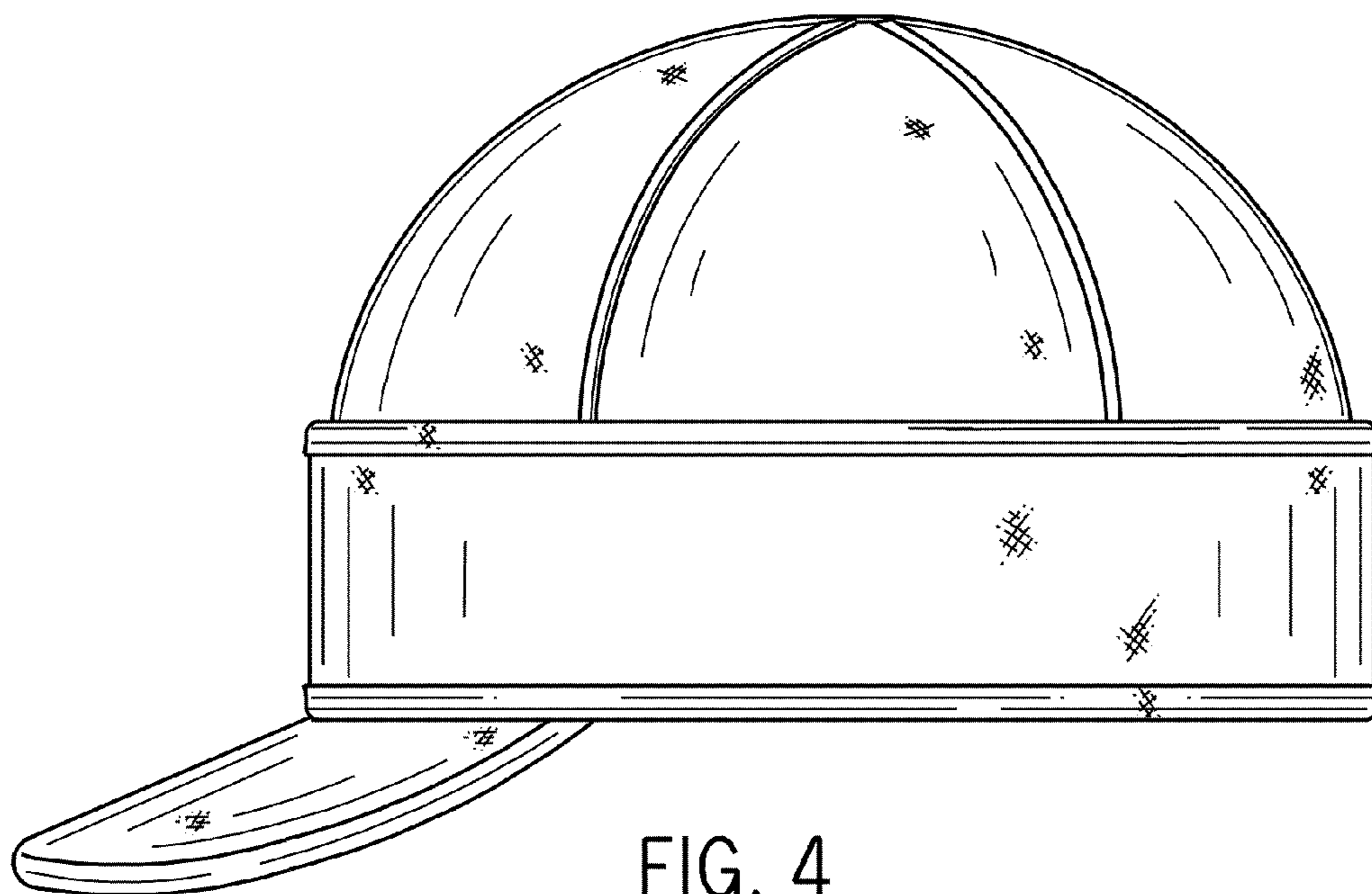

FIG. 4

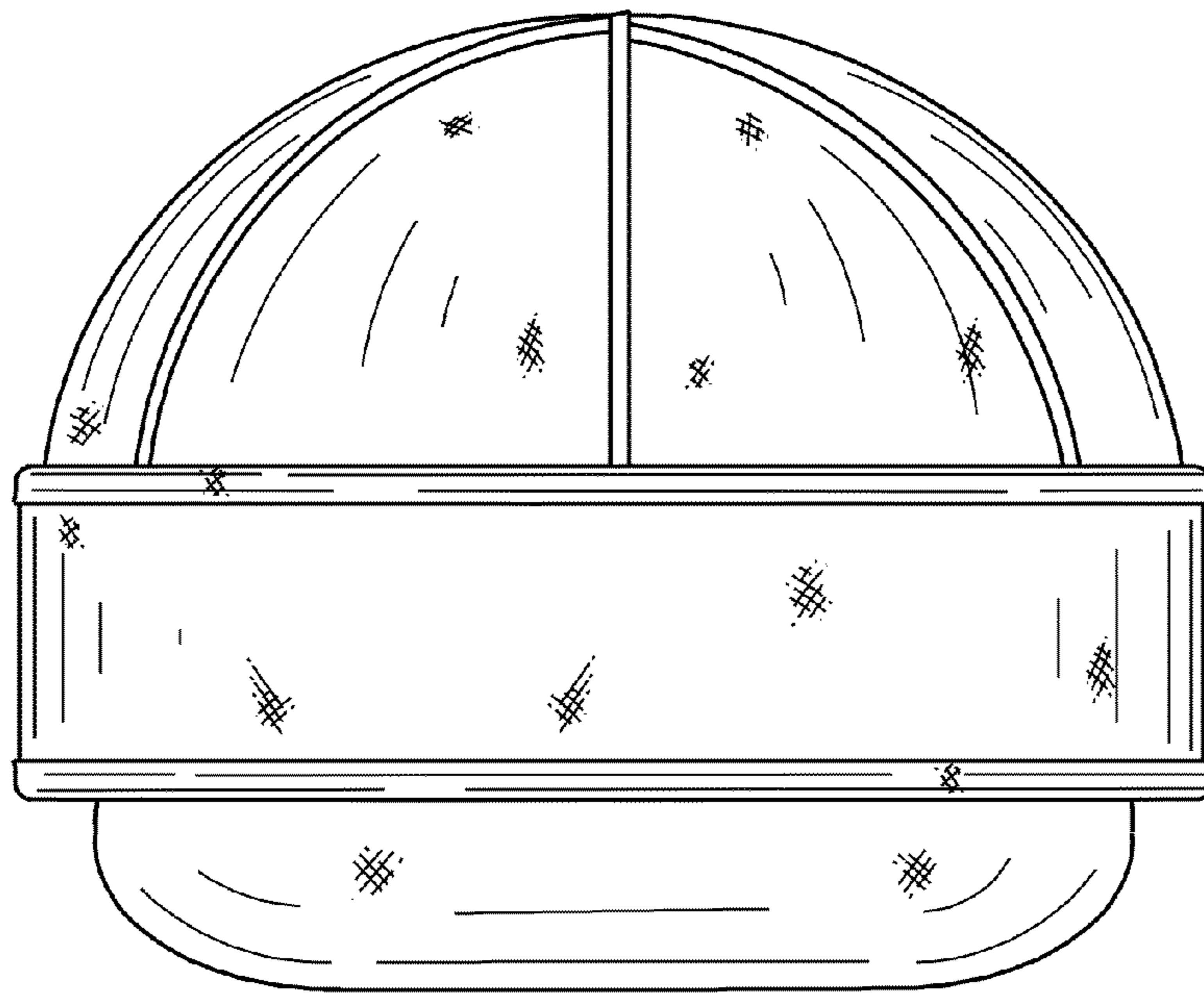

FIG. 5

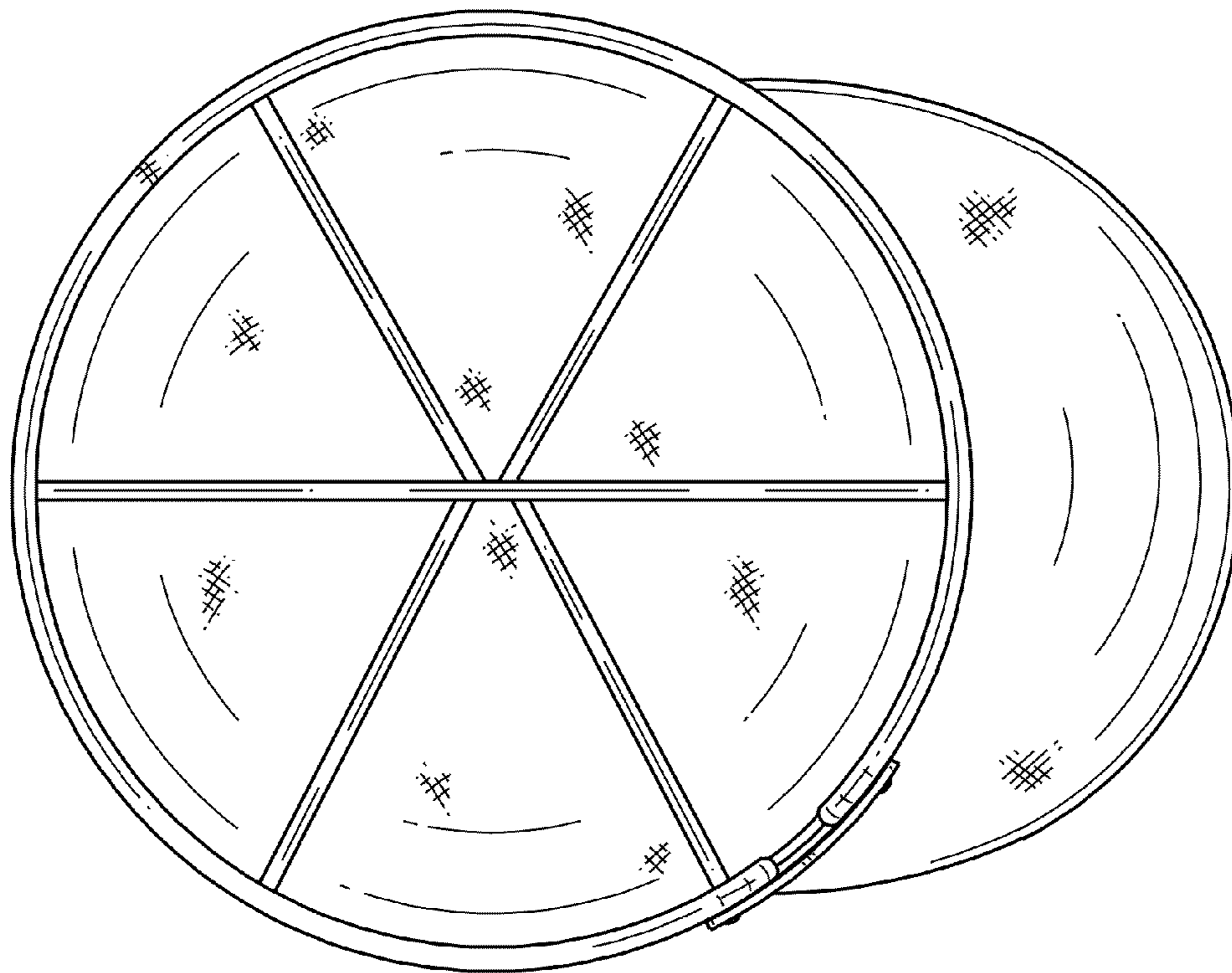

FIG. 6

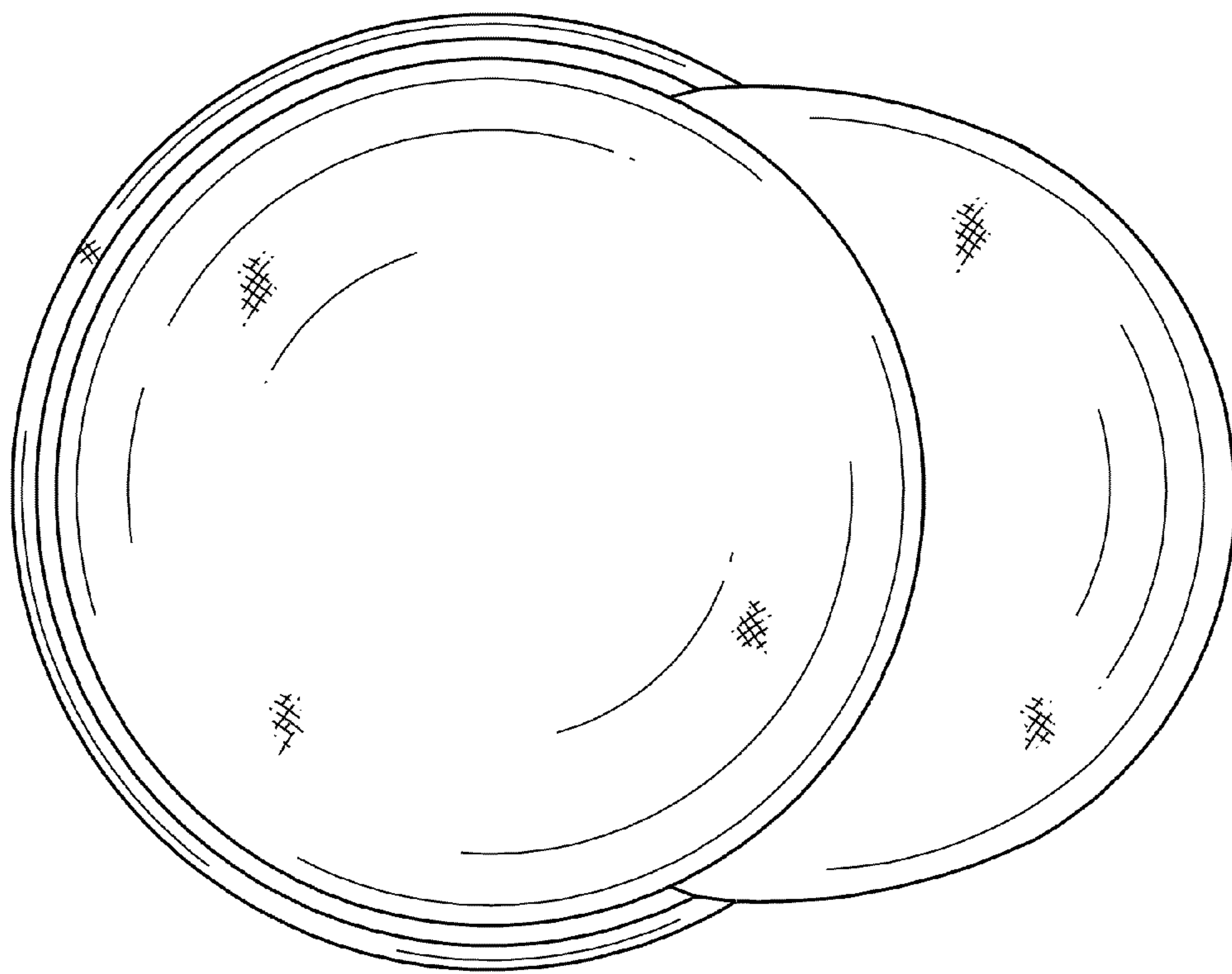

FIG. 7