



US00D694367S

(12) **United States Design Patent**  
**Starck**

(10) **Patent No.:** **US D694,367 S**  
(45) **Date of Patent:** **\*\* Nov. 26, 2013**

(54) **WALL-MOUNTED SHOWER UNIT**

FOREIGN PATENT DOCUMENTS

(75) Inventor: **Philippe Starck**, Paris (FR)  
(73) Assignee: **Hansgrohe SE**, Schiltach (DE)  
(\*\*) Term: **14 Years**

EM 000114103-0001 12/2003  
EM 000114103-0002 12/2003  
EM 000125000-0005 1/2004  
EM 000125000-0006 1/2004

\* cited by examiner

(21) Appl. No.: **29/431,599**  
(22) Filed: **Sep. 10, 2012**

*Primary Examiner* — Robert Delehanty  
(74) *Attorney, Agent, or Firm* — Nirav D. Parikh

(30) **Foreign Application Priority Data**

Mar. 16, 2012 (EM) ..... 001318273-0005

(51) **LOC (9) Cl.** ..... **23-01**

(52) **U.S. Cl.**  
USPC ..... **D23/238**

(58) **Field of Classification Search**  
USPC ..... D23/238–243, 249–250, 255, 257;  
4/675–678; 138/801  
See application file for complete search history.

(57) **CLAIM**

The ornamental design for a wall-mounted shower unit, as shown and described.

(56) **References Cited**

U.S. PATENT DOCUMENTS

D438,597 S \* 3/2001 Gottwald et al. .... D23/238  
D560,759 S \* 1/2008 Heck et al. .... D23/238  
D667,087 S \* 9/2012 Shieh ..... D23/239

**DESCRIPTION**

FIG. 1 is a perspective view of a wall-mounted shower unit showing my design;  
FIG. 2 is a front elevational view thereof;  
FIG. 3 is a rear elevational view thereof;  
FIG. 4 is a left side elevational view thereof;  
FIG. 5 is a right side elevational view thereof;  
FIG. 6 is a top plan view thereof; and,  
FIG. 7 is a bottom plan view thereof.

**1 Claim, 7 Drawing Sheets**

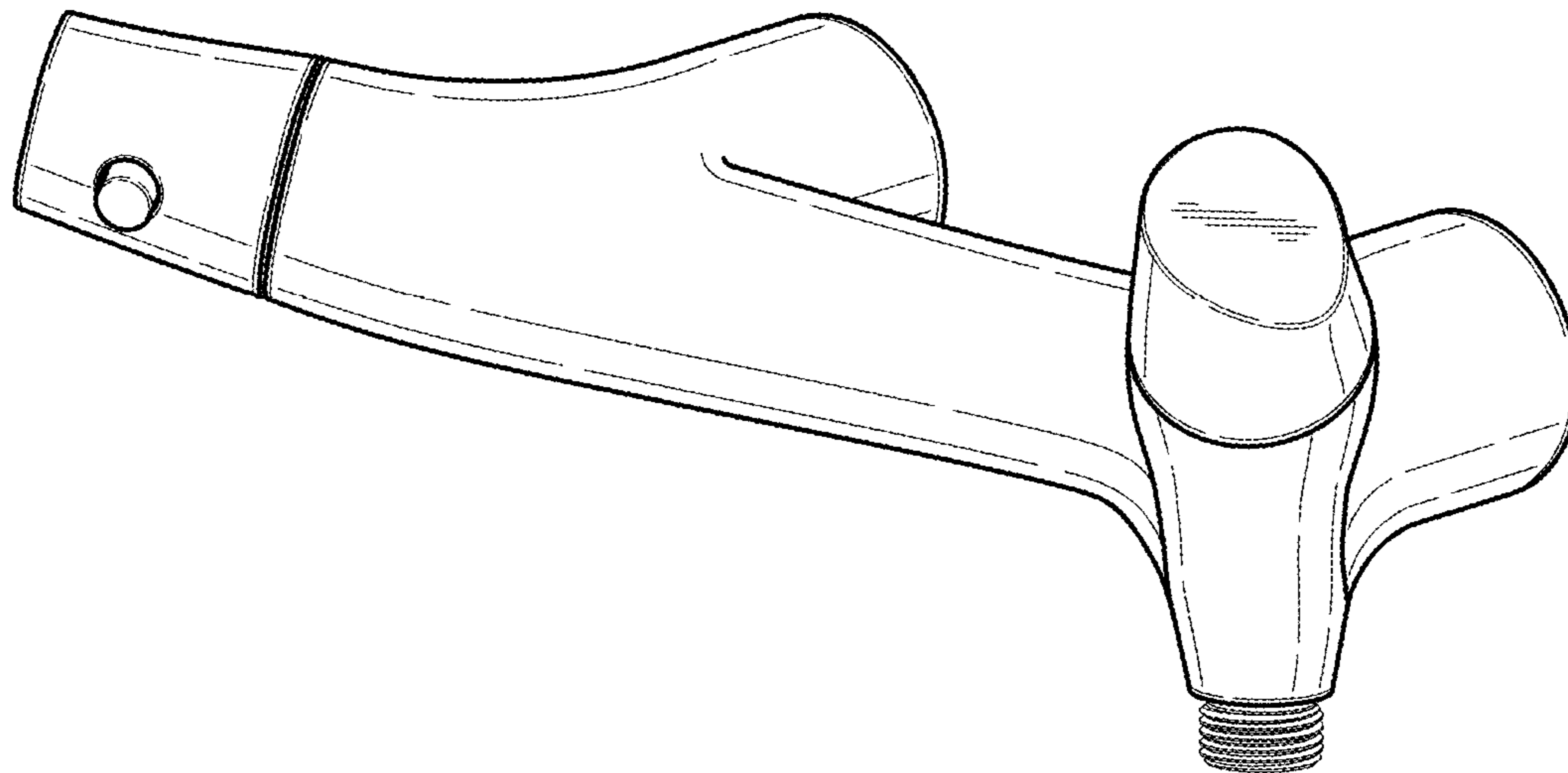

FIG. 1

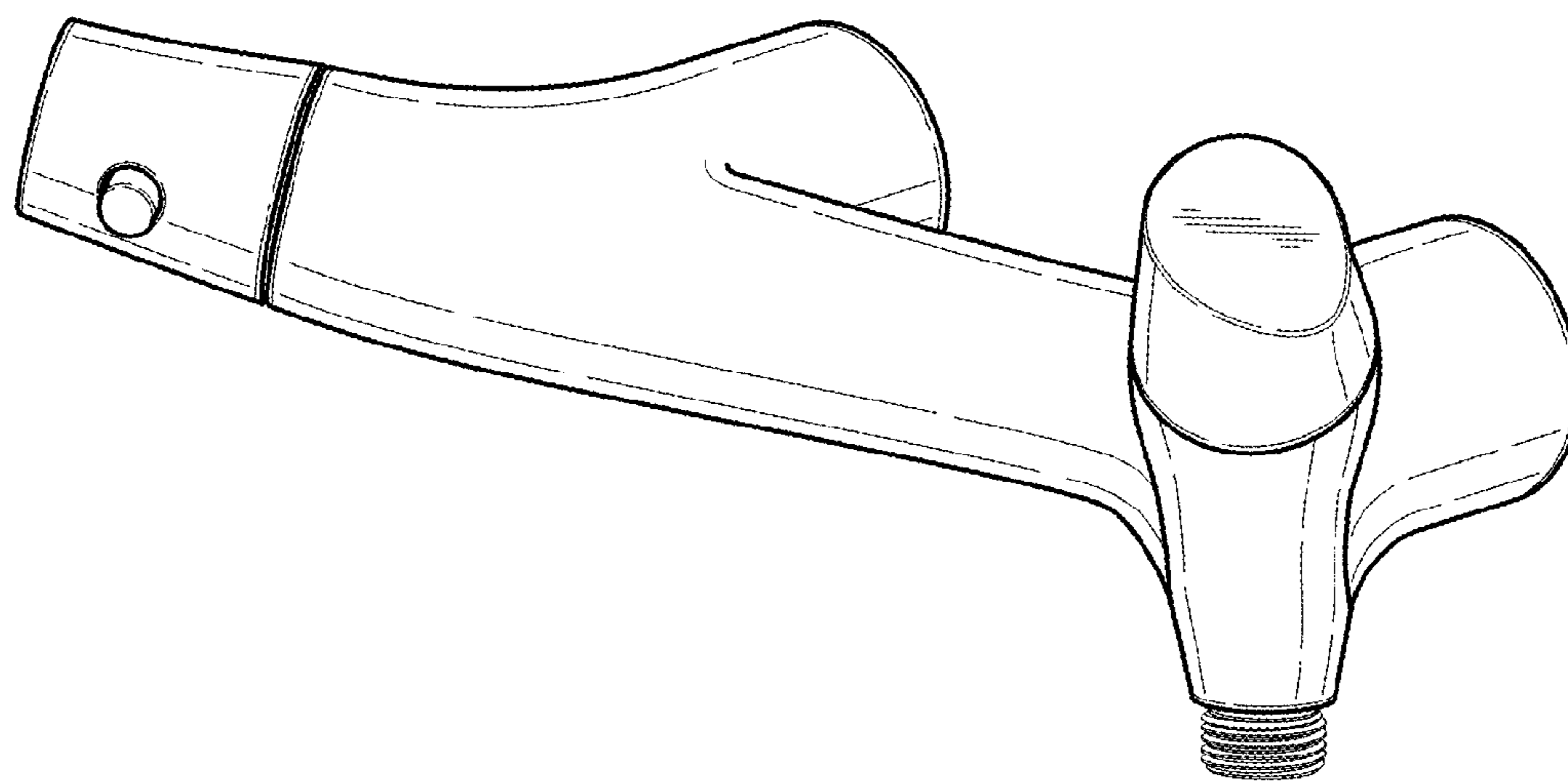

FIG. 2

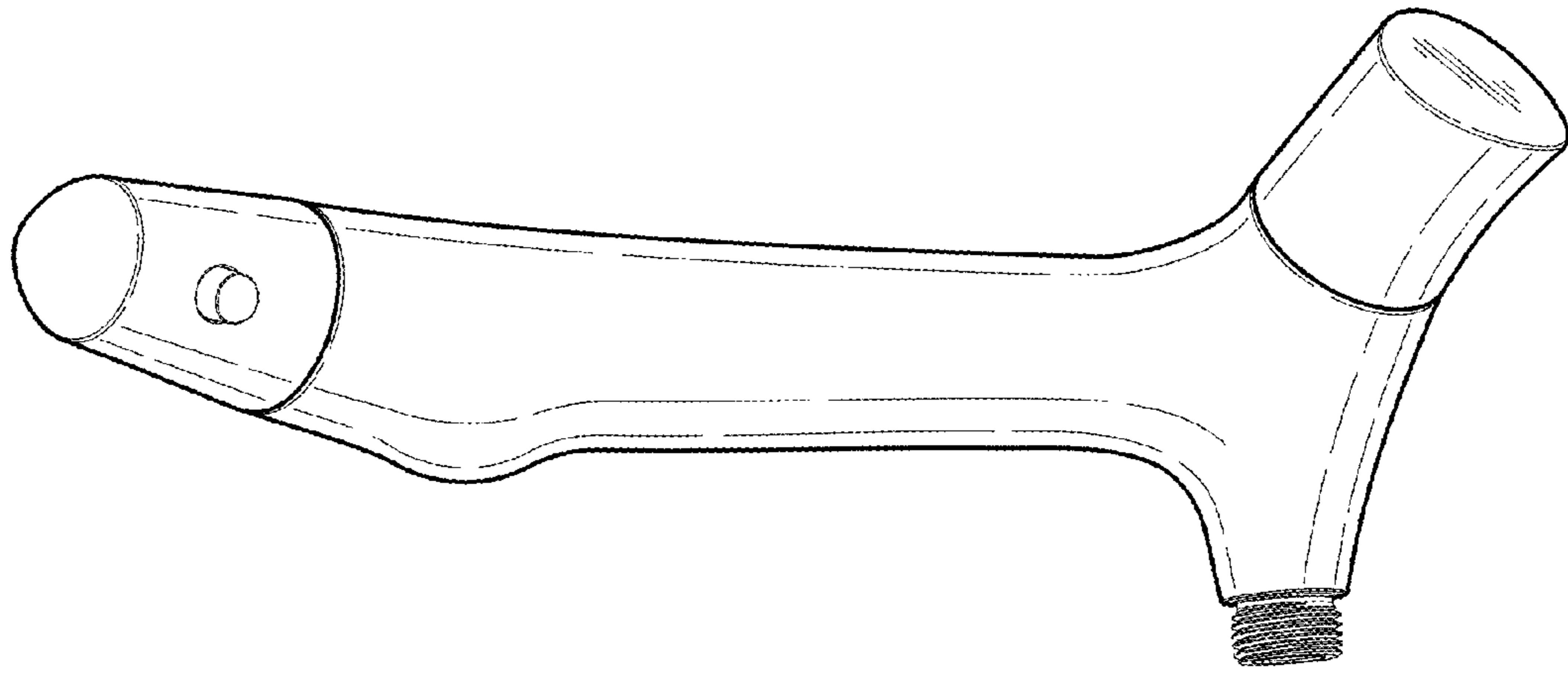

FIG. 3

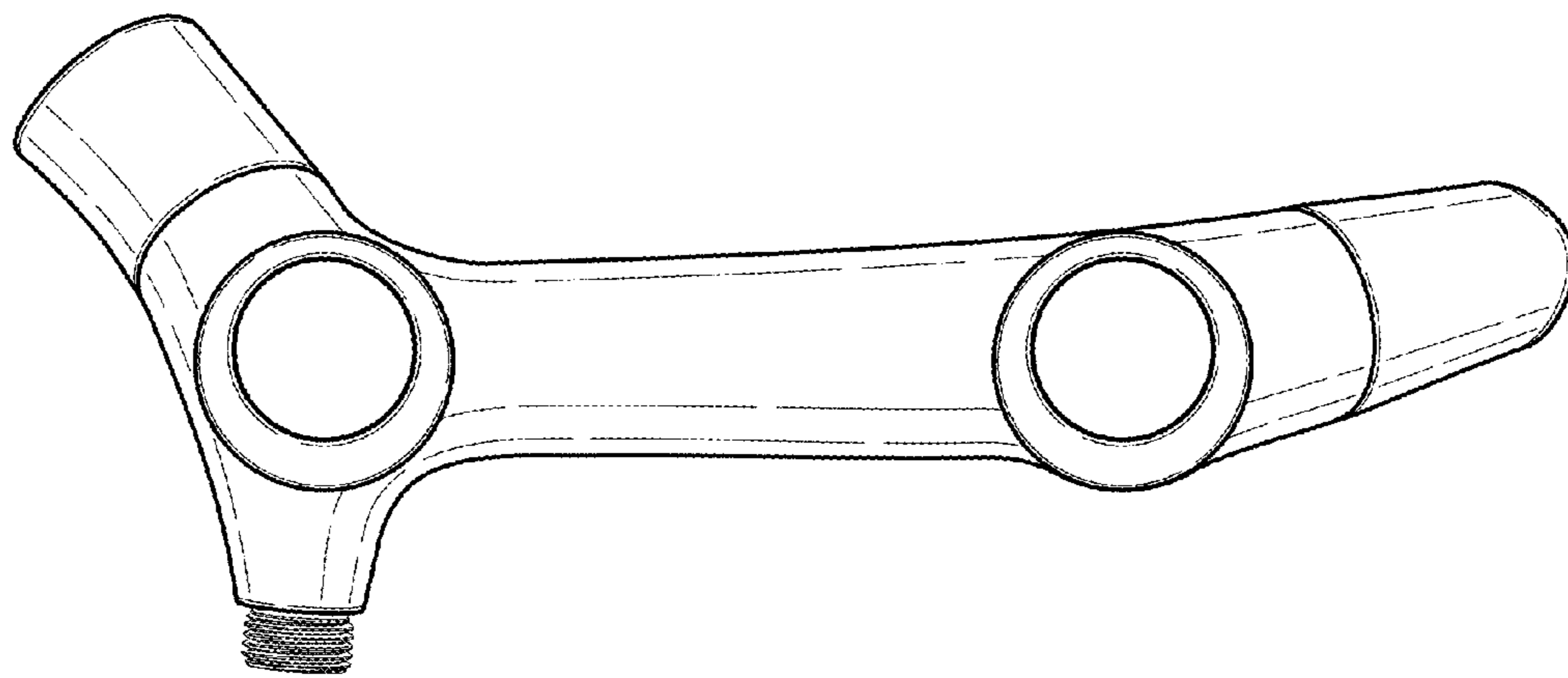

FIG. 4

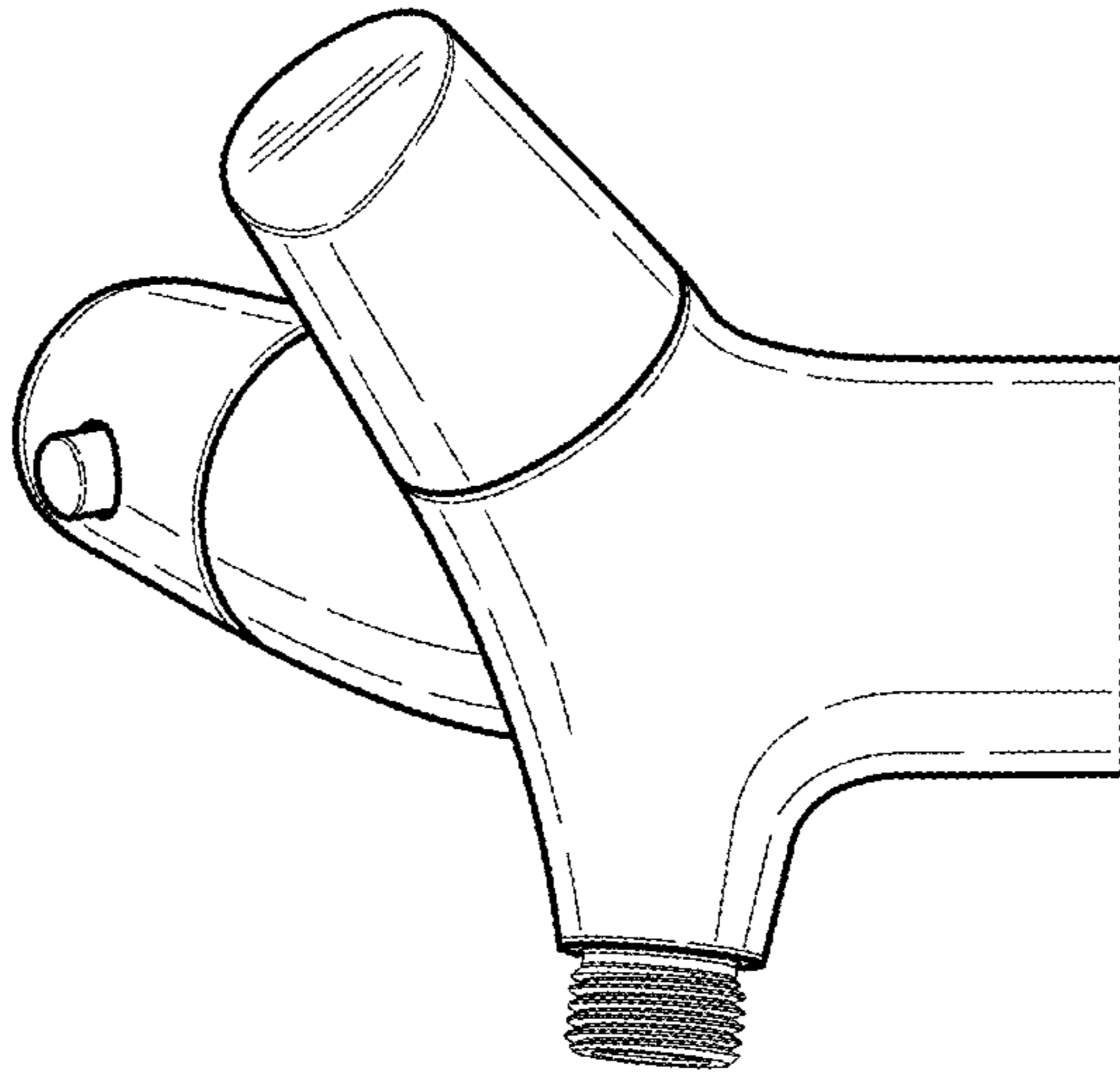

FIG. 5

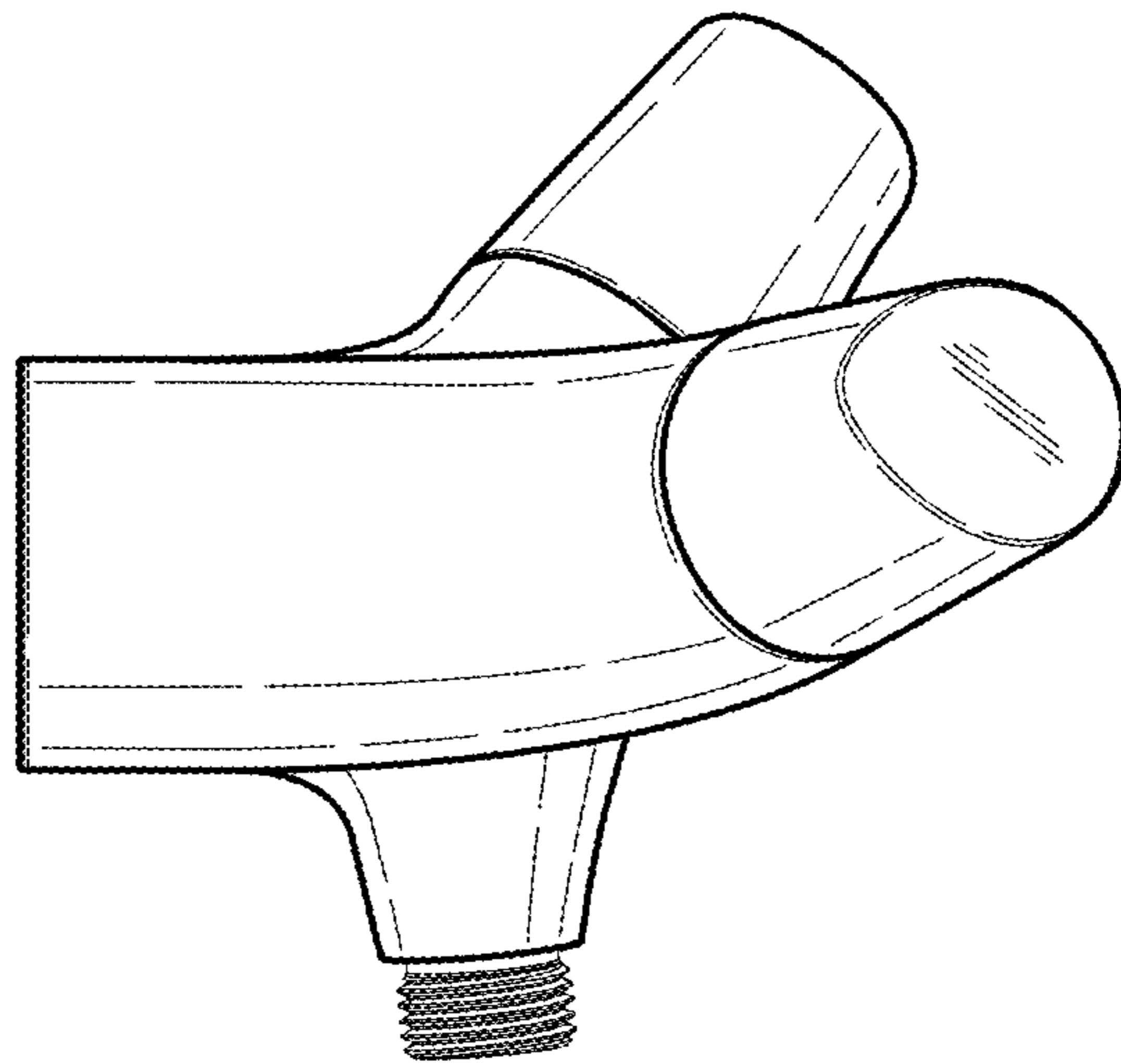

FIG. 6

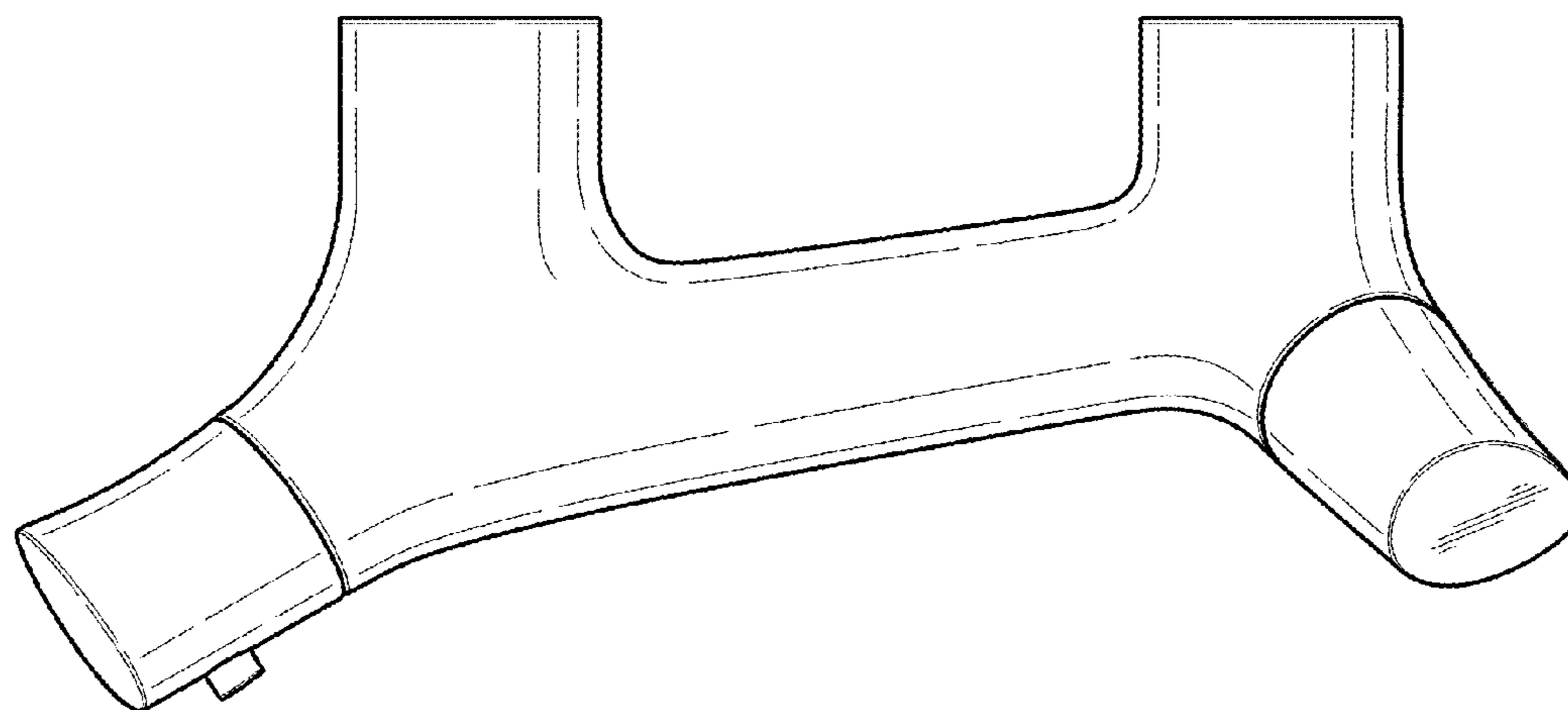

FIG. 7

