

US00D694298S

(12) **United States Design Patent**
Hoelbl

(10) **Patent No.:** **US D694,298 S**

(45) **Date of Patent:** **** Nov. 26, 2013**

(54) **COATER**

(71) Applicant: **Leica Mikrosysteme GmbH**, Vienna (AT)

(72) Inventor: **Werner Hoelbl**, Vienna (AT)

(73) Assignee: **Leica Mikrosysteme GmbH**, Vienna (AT)

(**) Term: **14 Years**

(21) Appl. No.: **29/453,731**

(22) Filed: **May 2, 2013**

Related U.S. Application Data

(62) Division of application No. 29/437,292, filed on Nov. 15, 2012, now Pat. No. Des. 685,825.

(51) **LOC (9) Cl.** **15-09**

(52) **U.S. Cl.**
USPC **D15/122**

(58) **Field of Classification Search**
USPC D15/122, 124, 199; 118/64, 300, 309, 118/310, 324
See application file for complete search history.

(56) **References Cited**

U.S. PATENT DOCUMENTS

2,400,315 A 5/1946 Paasche
3,669,068 A 6/1972 Geitz

6,582,521 B2 *	6/2003	Bertellotti et al.	118/621
D567,264 S	4/2008	Muller et al.	
D621,426 S	8/2010	Fusejima et al.	
D655,323 S	3/2012	Brockhage	
D674,420 S	1/2013	Ueberschlag et al.	
2006/0147633 A1	7/2006	Jones	
2006/0233960 A1	10/2006	Warren et al.	
2008/0003349 A1	1/2008	Van Sciver et al.	
2009/0101068 A1 *	4/2009	Boyd et al.	118/713
2010/0206223 A1 *	8/2010	Pilipauskas et al.	118/319
2011/0030201 A1 *	2/2011	Inaba et al.	29/729
2012/0288973 A1	11/2012	Matsunaga	

* cited by examiner

Primary Examiner — Patricia Palasik

(74) *Attorney, Agent, or Firm* — Crowell & Moring LLP

(57) **CLAIM**

The ornamental design for a coater, as shown and described.

DESCRIPTION

FIG. 1 is a front view of a first embodiment of a coater according to the design;
FIG. 2 is a rear view thereof;
FIG. 3 is a left side view thereof;
FIG. 4 is a right side view thereof;
FIG. 5 is a top view thereof;
FIG. 6 is a bottom view thereof; and,
FIG. 7 is a right, front, elevated perspective view thereof.

1 Claim, 7 Drawing Sheets

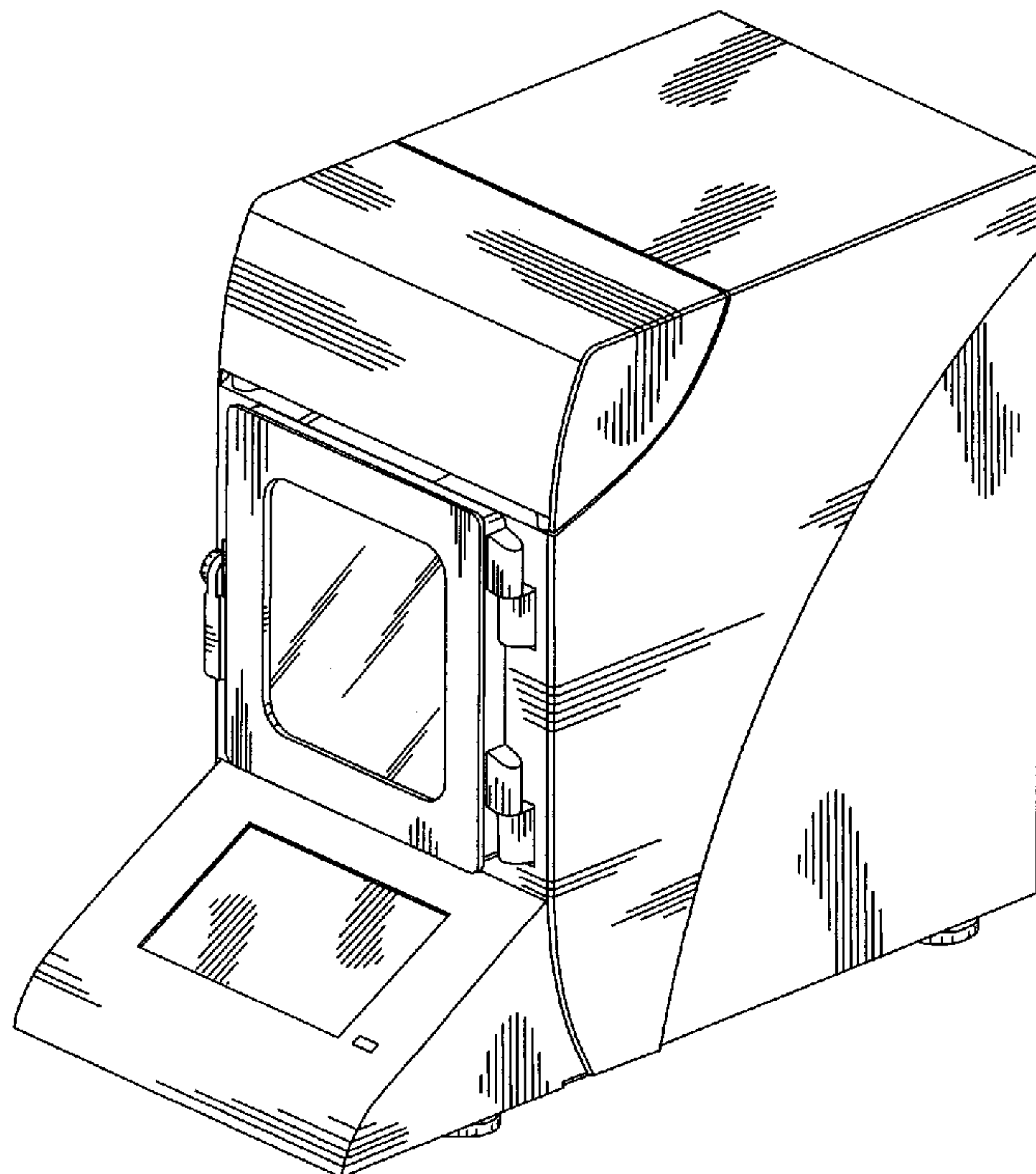

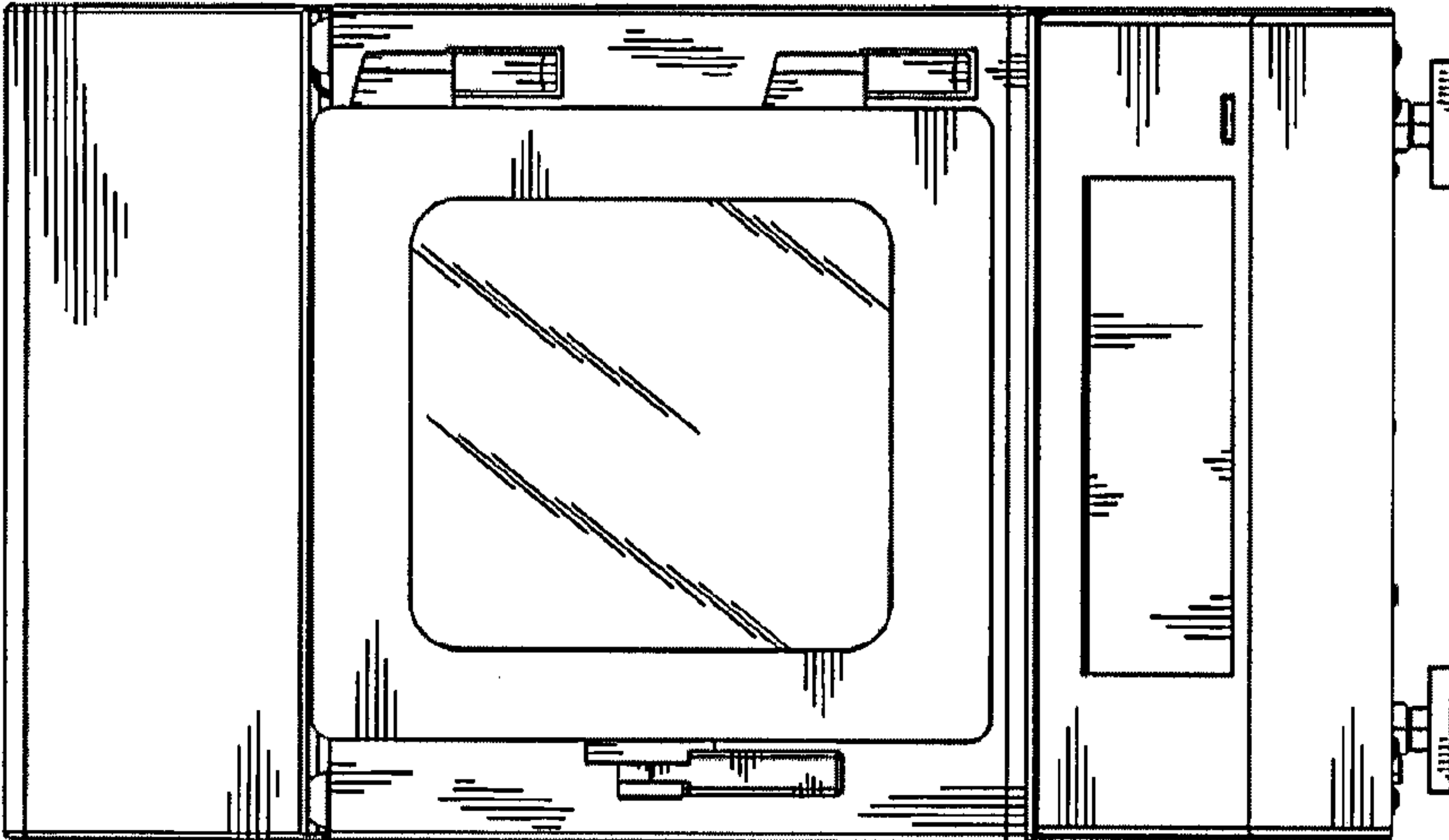

FIG. 1

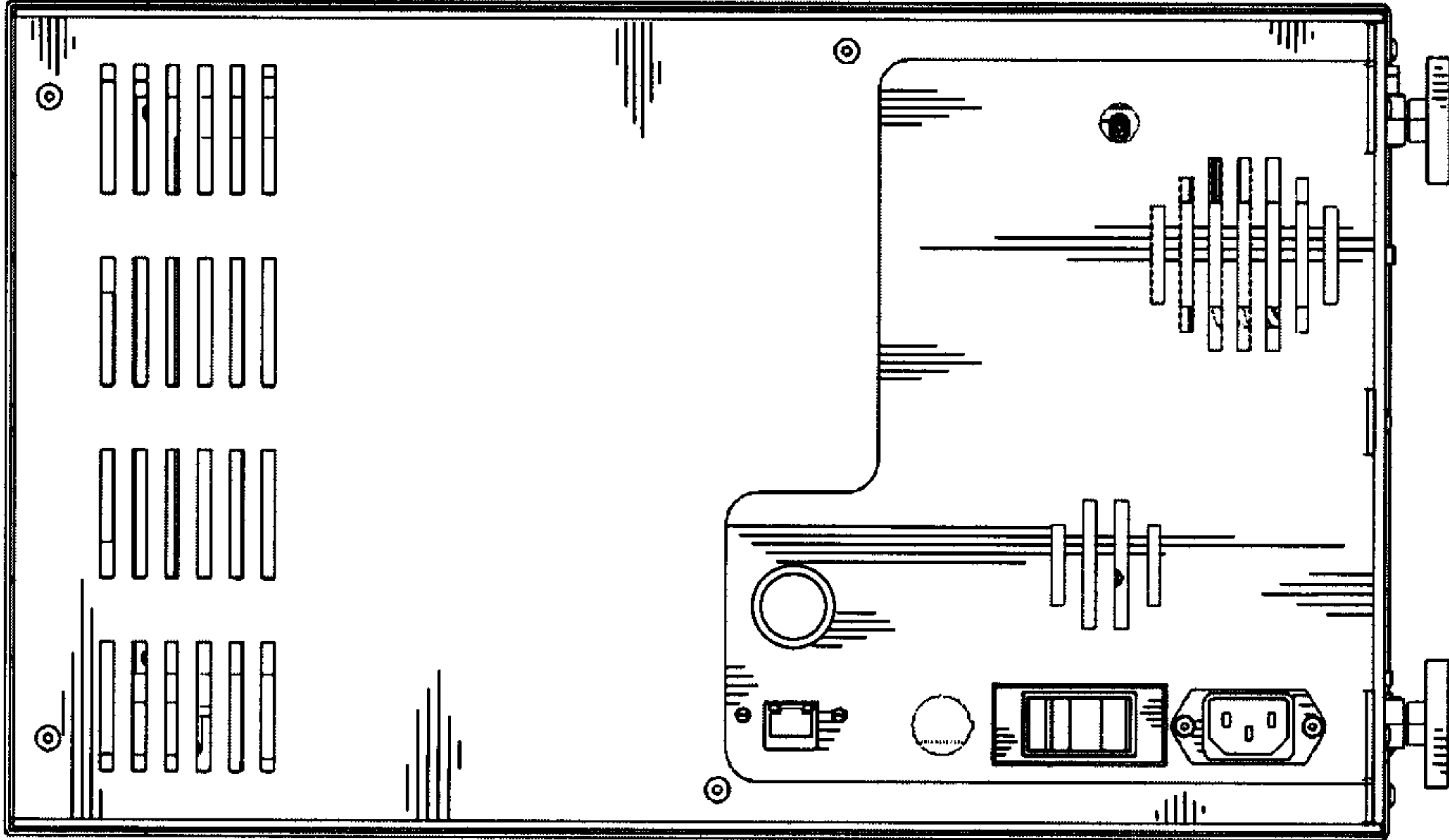

FIG. 2

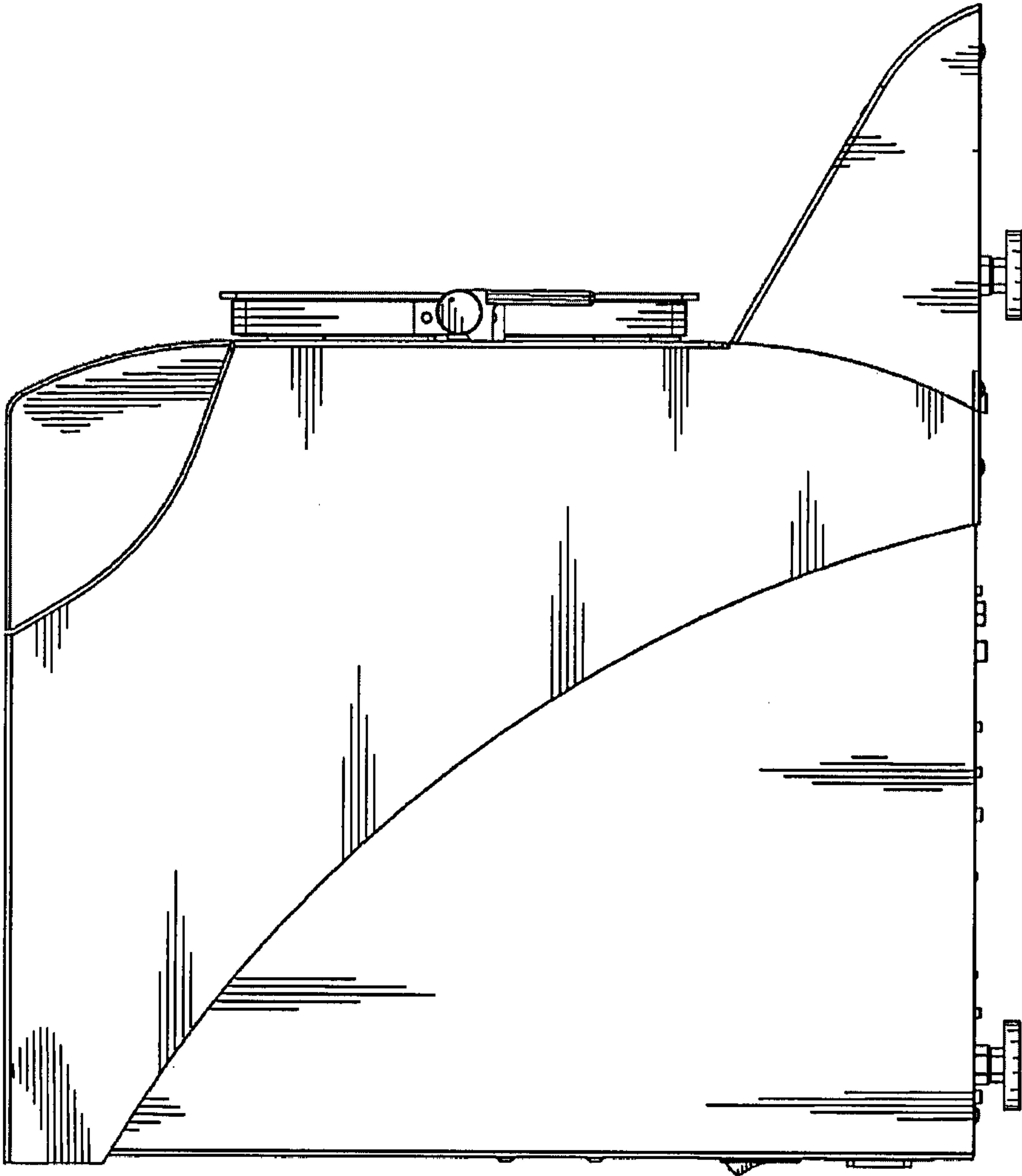

FIG. 3

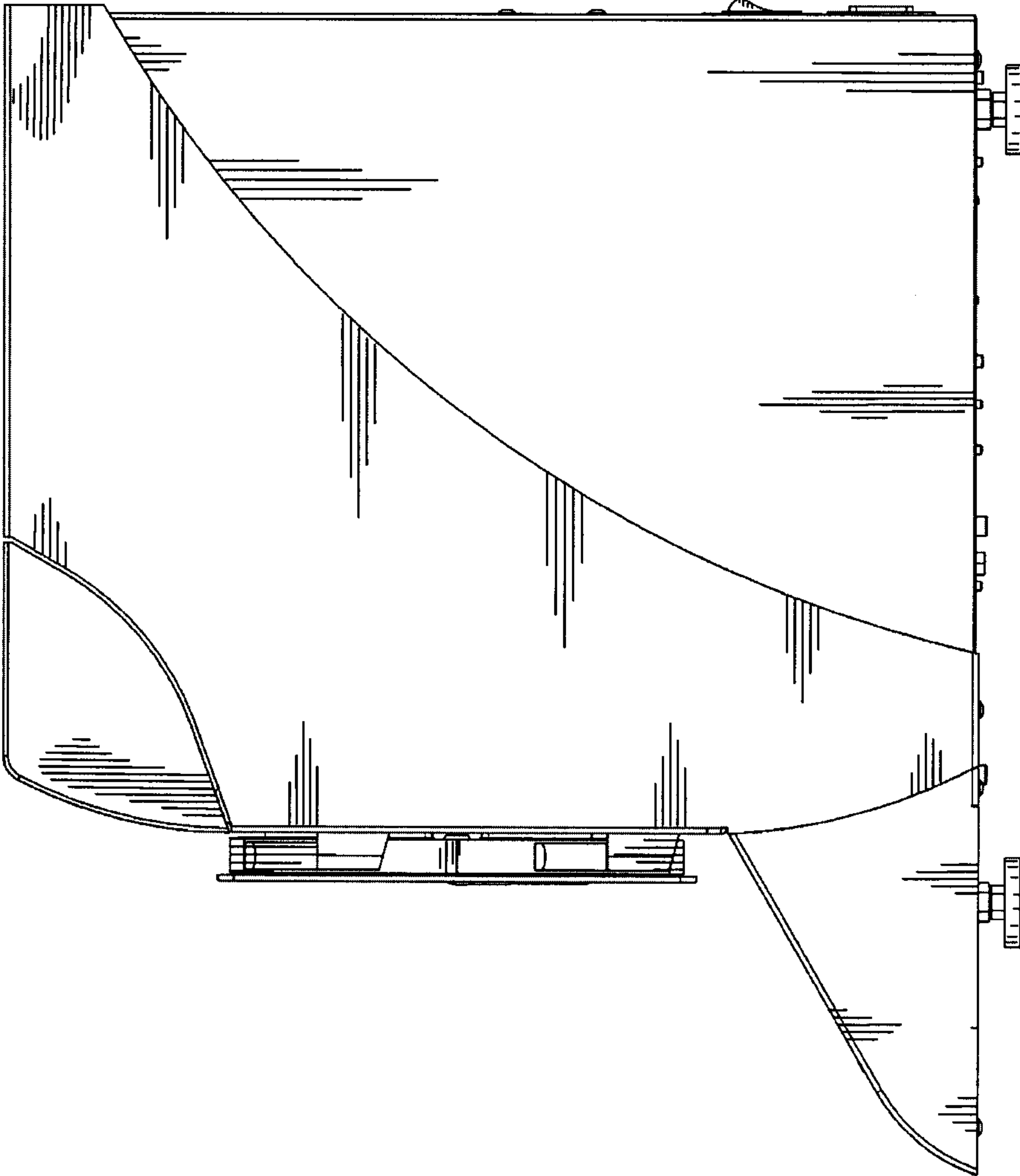

FIG. 4

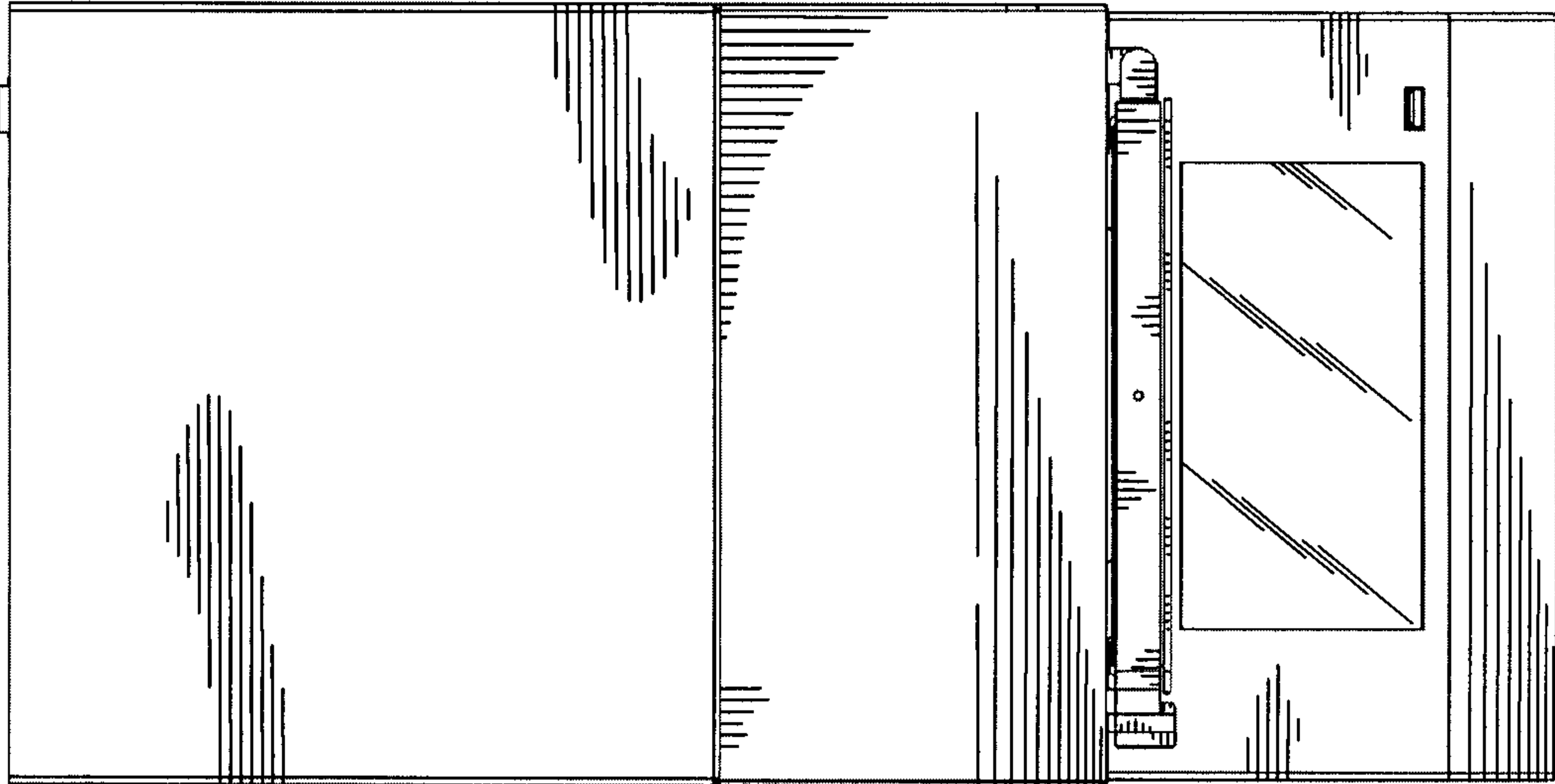

FIG. 5

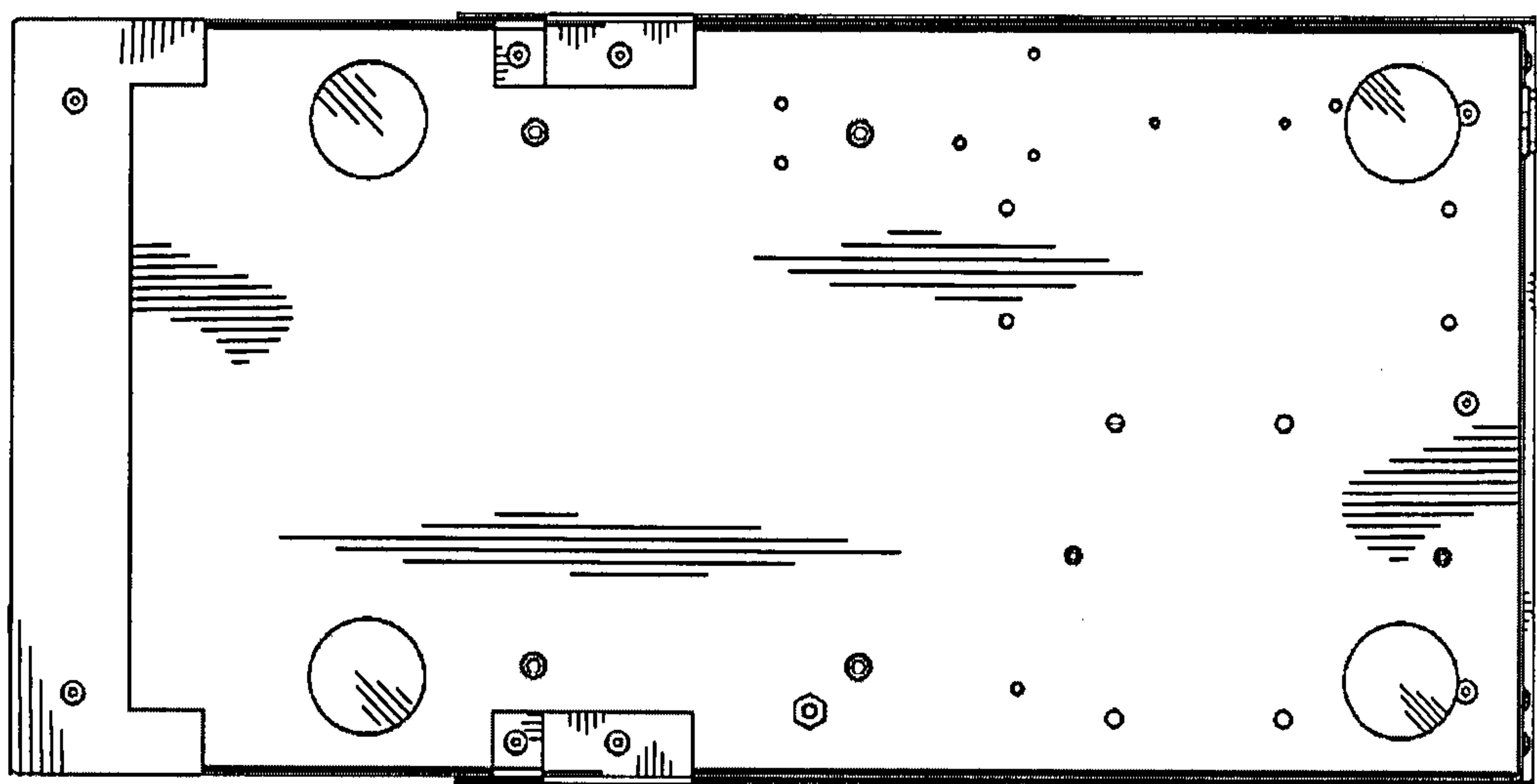

FIG. 6

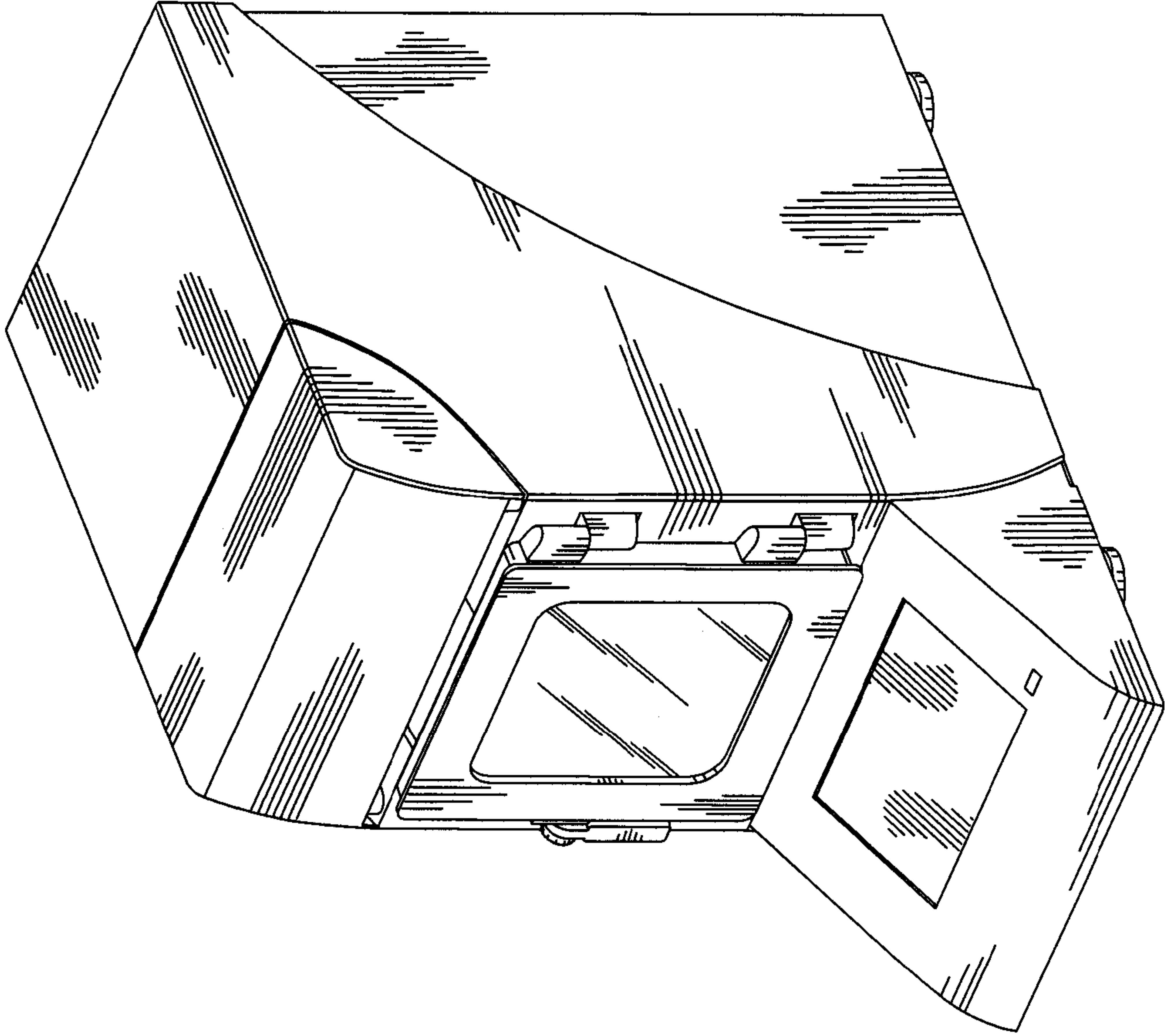

FIG. 7