



US00D694220S

(12) **United States Design Patent**  
**Lee et al.**

(10) **Patent No.:** **US D694,220 S**  
(45) **Date of Patent:** **\*\* Nov. 26, 2013**

(54) **HEADPHONE**

(75) Inventors: **Noel Lee**, Las Vegas, NV (US); **Jacky Hsiung**, San Jose, CA (US)

(73) Assignee: **Monster, LLC**, Las Vegas, NV (US)

(\*\*) Term: **14 Years**

(21) Appl. No.: **29/430,116**

(22) Filed: **Aug. 21, 2012**

(51) **LOC (9) Cl.** ..... **14-01**

(52) **U.S. Cl.**  
USPC ..... **D14/223**

(58) **Field of Classification Search**  
USPC ..... D14/205, 223; 181/129, 130, 135;  
379/430, 431; 381/380, 381; 455/90.3,  
455/575.1

See application file for complete search history.

(56) **References Cited**

**U.S. PATENT DOCUMENTS**

2,248,837	A *	7/1941	Walters	381/380
4,588,867	A *	5/1986	Konomi	379/430
5,410,608	A *	4/1995	Lucey et al.	381/360
5,420,935	A *	5/1995	Shinohara et al.	381/370
5,544,253	A *	8/1996	Nagayoshi et al.	381/385
5,809,159	A *	9/1998	Lee	381/380
D497,613	S *	10/2004	Gwee	D14/223
D505,132	S *	5/2005	Linville et al.	D14/223
D515,070	S *	2/2006	Andre et al.	D14/205
D558,735	S *	1/2008	Carr et al.	D14/206
7,349,550	B2 *	3/2008	Oliveira et al.	381/380
D572,703	S *	7/2008	Ledbetter et al.	D14/205
D593,537	S *	6/2009	Arimoto	D14/205
D594,441	S *	6/2009	Lee et al.	D14/205
D598,894	S *	8/2009	Masuda et al.	D14/205
D599,781	S *	9/2009	Lee et al.	D14/205

D626,117	S *	10/2010	Lowry	D14/223
7,965,855	B1 *	6/2011	Ham	381/380
D641,008	S *	7/2011	Lee et al.	D14/223
D641,010	S *	7/2011	Kwon	D14/223
7,979,035	B2 *	7/2011	Griffin et al.	455/90.3
D643,416	S *	8/2011	Chong et al.	D14/223
8,111,861	B2 *	2/2012	Lowry	381/380
D664,523	S *	7/2012	Naitou	D14/223
D666,580	S *	9/2012	Lee et al.	D14/223
D669,058	S *	10/2012	Lee et al.	D14/223
D676,427	S *	2/2013	Yang	D14/223
D678,252	S *	3/2013	Cantoni et al.	D14/223
D679,267	S *	4/2013	Lee et al.	D14/223

\* cited by examiner

*Primary Examiner* — Paula Greene

(74) *Attorney, Agent, or Firm* — LaRiviere, Grubman & Payne, LLP

(57) **CLAIM**

The ornamental design for a headphone, as shown and described.

**DESCRIPTION**

FIG. 1 is a front perspective view of a headphone, showing our new design in a use condition;

FIG. 2 is a front view thereof;

FIG. 3 is a rear view thereof;

FIG. 4 is a side view thereof;

FIG. 5 is an opposing side view thereof;

FIG. 6 is a top view thereof;

FIG. 7 is a bottom view thereof; and,

FIG. 8 is a perspective view thereof showing the earhook portion in detached condition.

The broken lines showing the environment in the Figures are for illustrative purposes only and form no part of the claimed design.

**1 Claim, 5 Drawing Sheets**

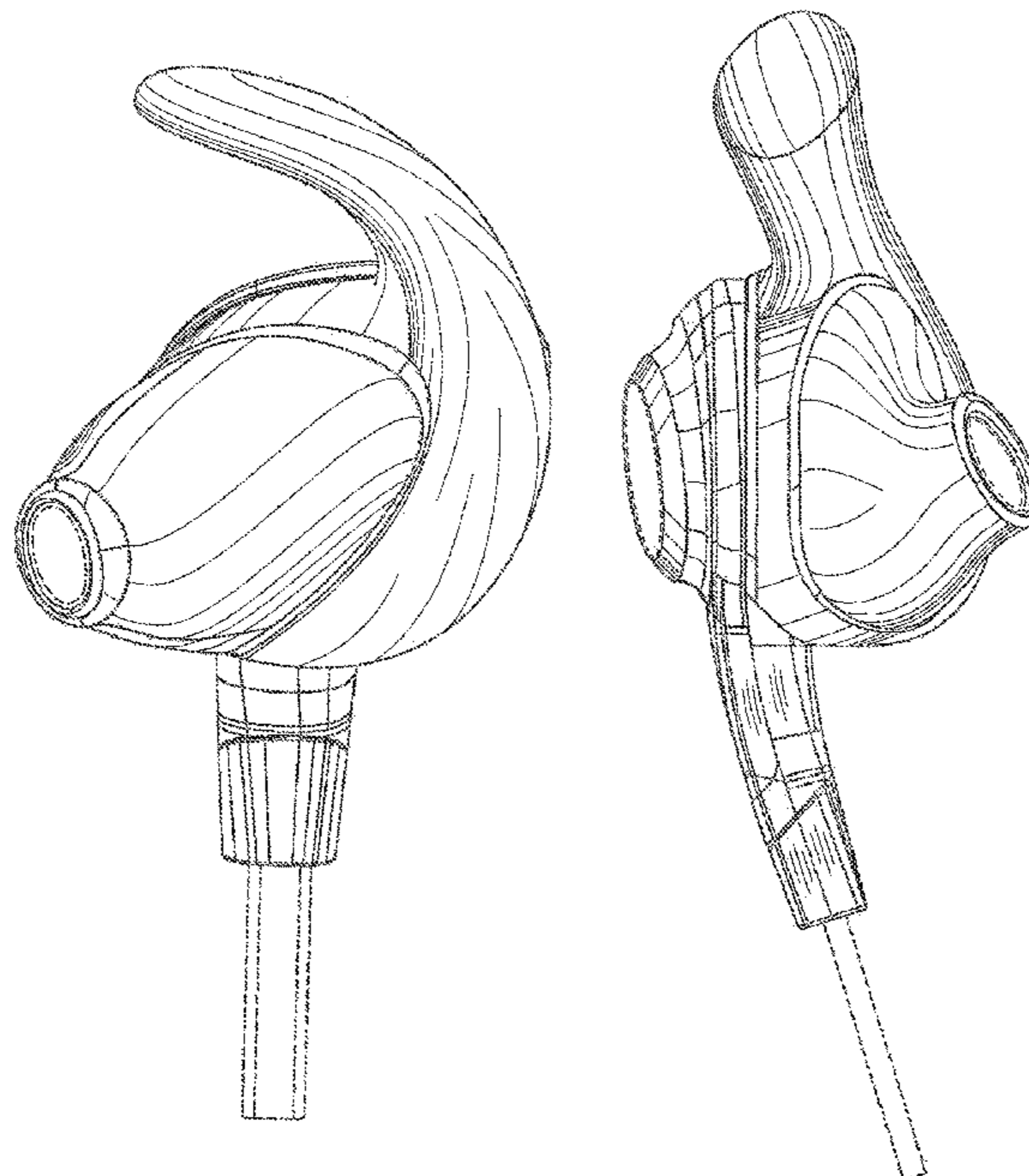

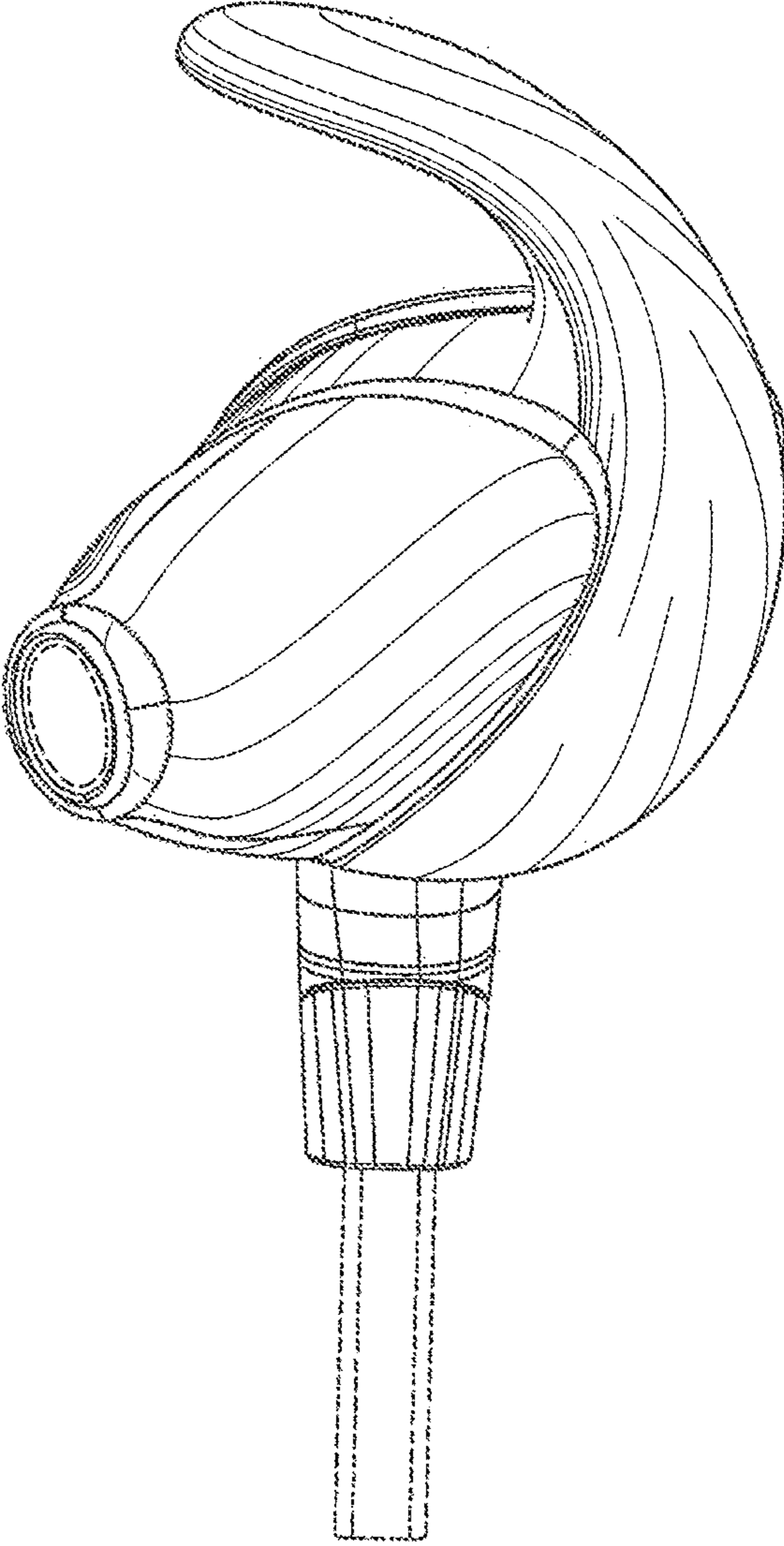

Figure 1

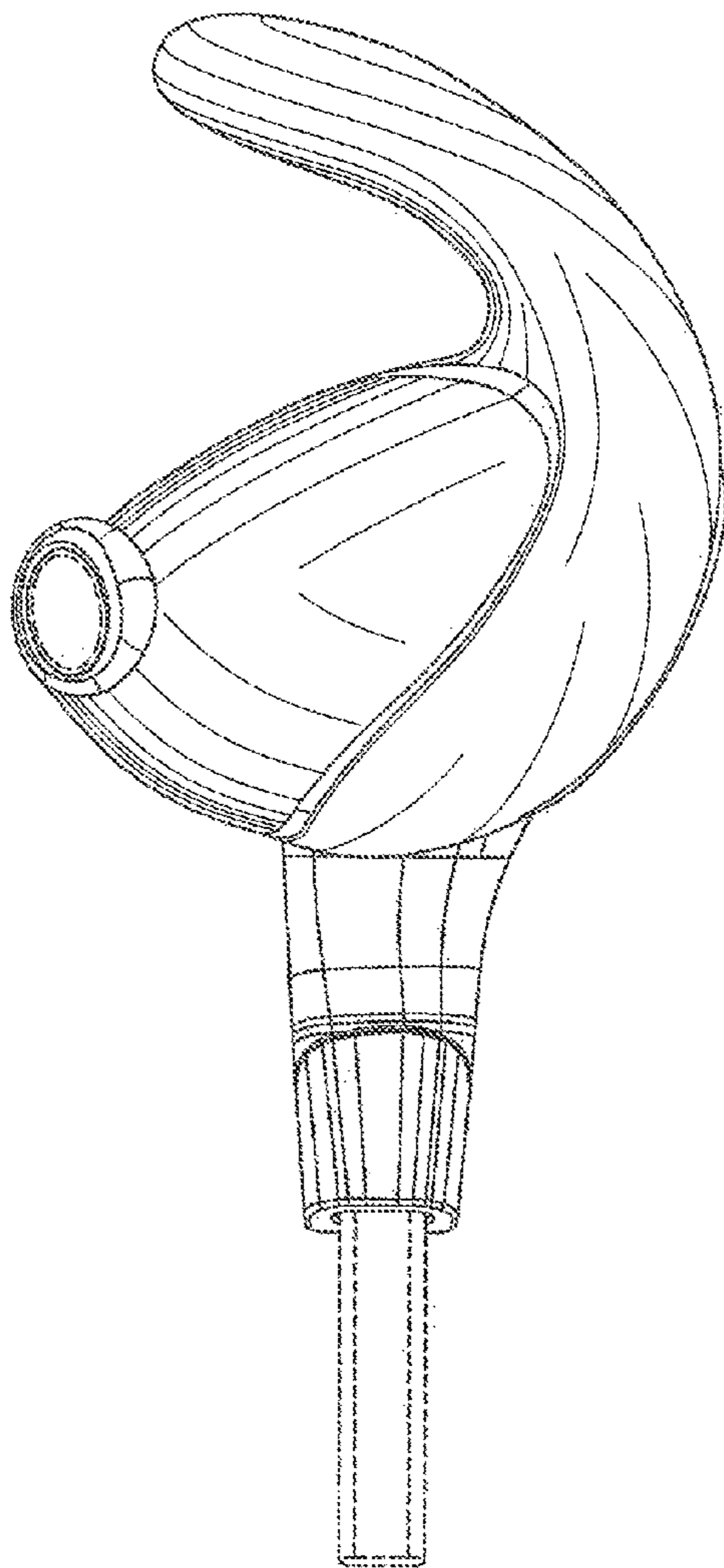

Figure 2

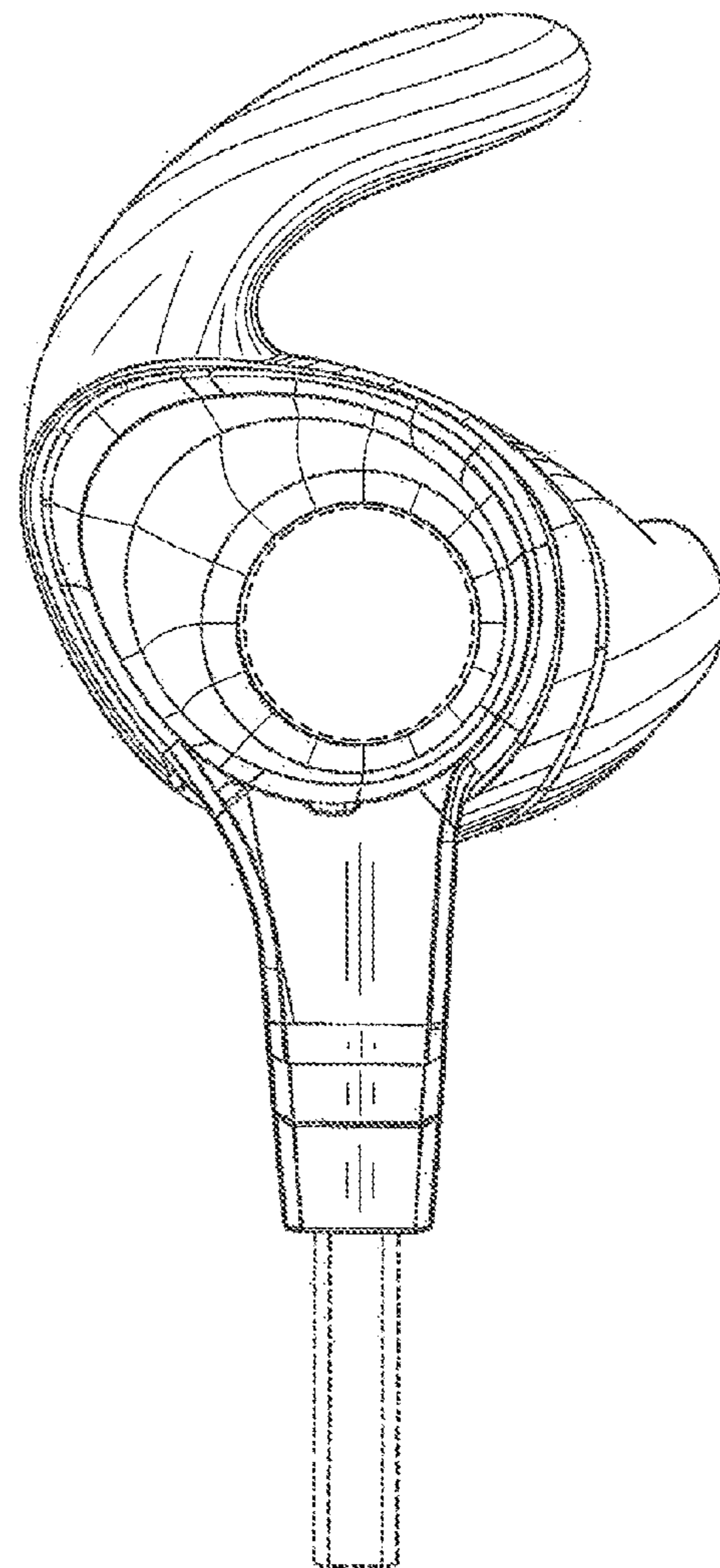

Figure 3



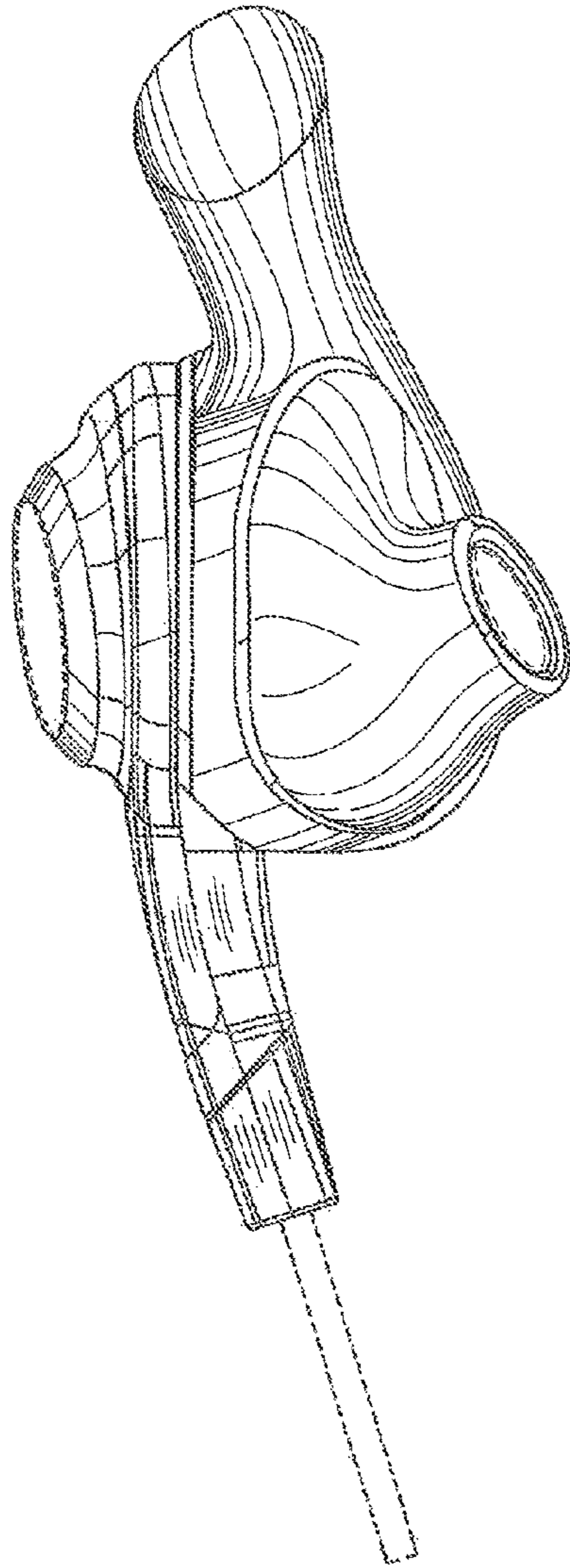

Figure 4

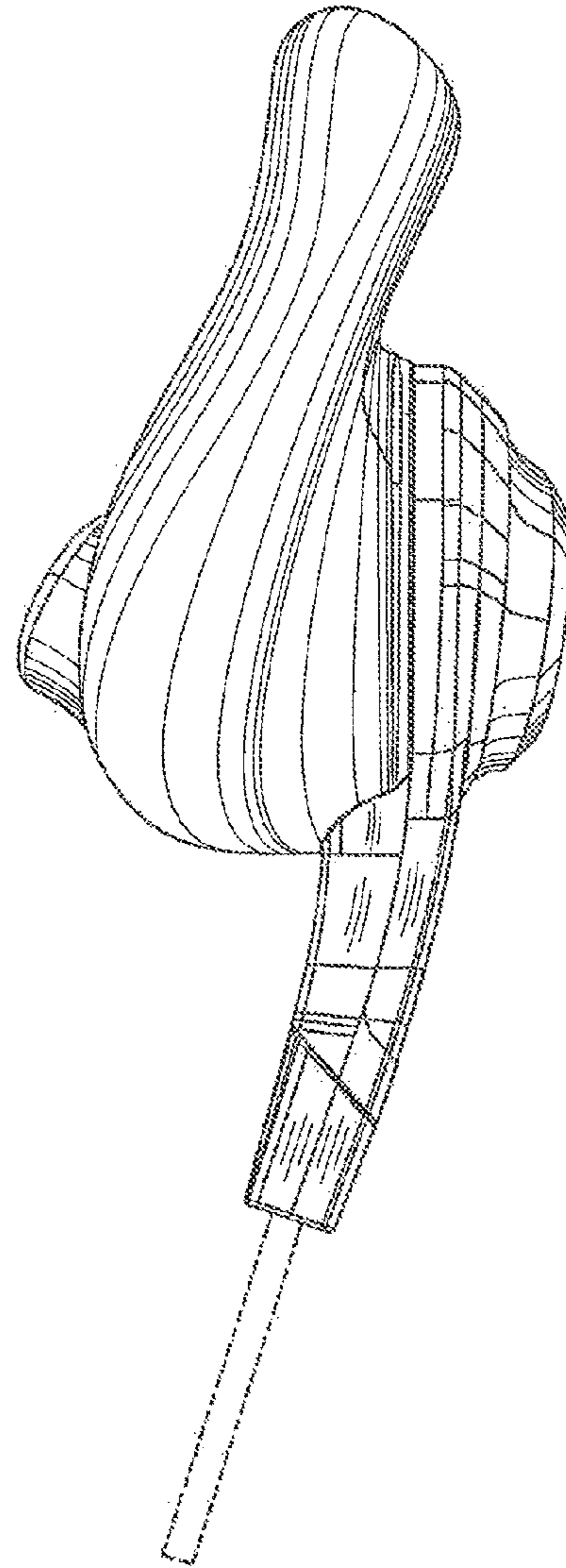

Figure 5

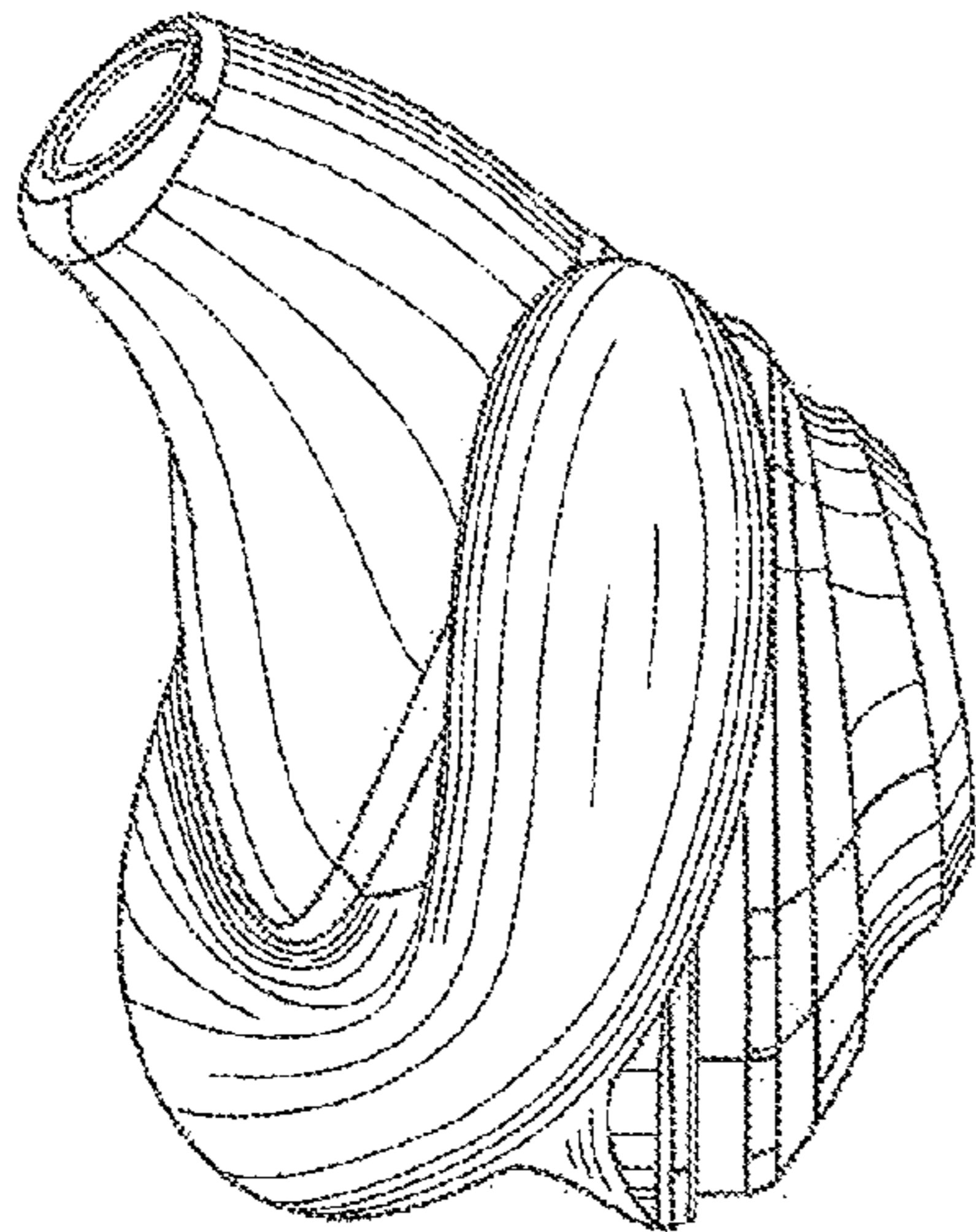

Figure 6

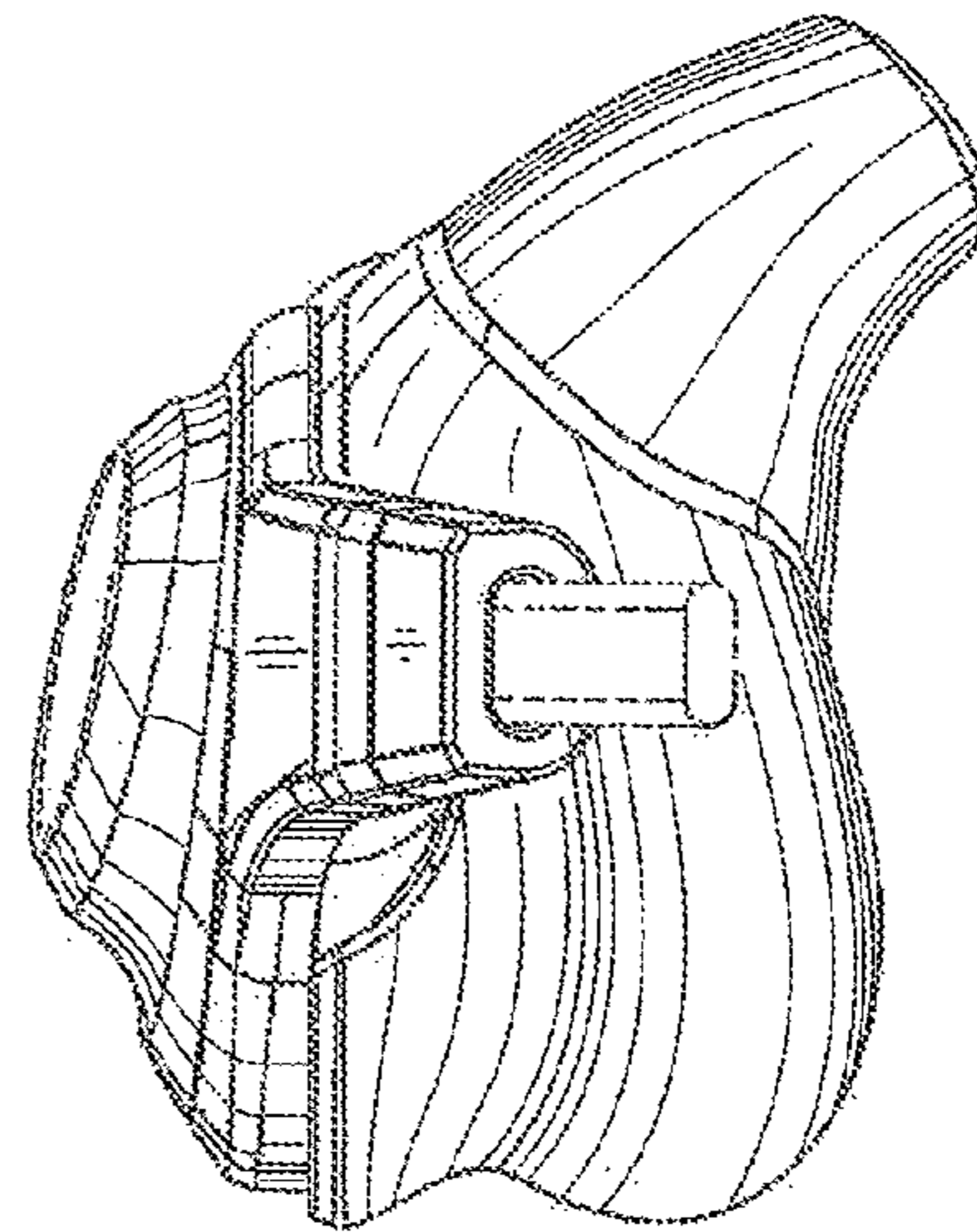

Figure 7

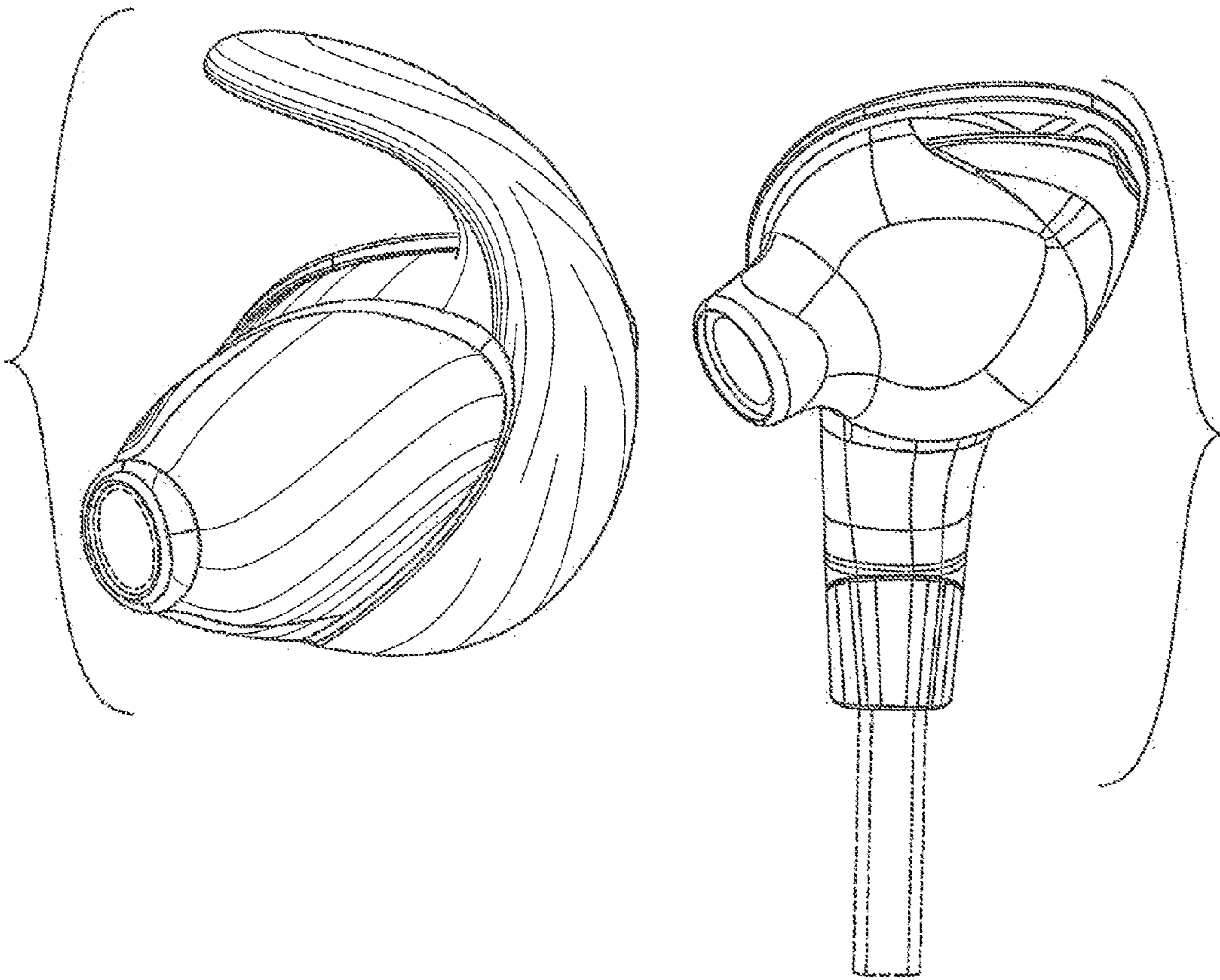

Figure 8