



US00D694163S

(12) **United States Design Patent**  
**Yamada et al.**

(10) **Patent No.:** **US D694,163 S**

(45) **Date of Patent:** **\*\* Nov. 26, 2013**

(54) **DOOR FOR AN AUTOMOBILE**

D659,622 S \* 5/2012 Matsumoto et al. .... D12/196  
D660,213 S \* 5/2012 Ikuma et al. .... D12/196  
D660,758 S \* 5/2012 Hakamata et al. .... D12/196

(75) Inventors: **Masayuki Yamada**, Aichi-ken (JP);  
**Junichi Toura**, Shizuoka-ken (JP)

**OTHER PUBLICATIONS**

(73) Assignee: **Toyota Jidosha Kabushiki Kaisha**,  
Toyota-shi, Aichi-ken (JP)

BMW 3-Series; www.webl.io.jp/; December 22, 2010.  
Corolla Sedan, www.corolla-m.co.jp/; Dec. 22, 2010.

(\*\*) Term: **14 Years**

\* cited by examiner

(21) Appl. No.: **29/418,013**

*Primary Examiner* — Melody Brown

(22) Filed: **Apr. 11, 2012**

(74) *Attorney, Agent, or Firm* — Finnegan, Henderson,  
Farabow, Garrett & Dunner, LLP

(30) **Foreign Application Priority Data**

(57) **CLAIM**

The ornamental design for a door for an automobile, as shown  
and described.

Oct. 28, 2011 (JP) ..... 2011-024848

**DESCRIPTION**

(51) **LOC (9) Cl.** ..... **12-16**

(52) **U.S. Cl.**  
USPC ..... **D12/196**

(58) **Field of Classification Search**  
USPC ..... D12/196, 90-92, 86; 296/181.1, 181.5  
See application file for complete search history.

FIG. 1 is a left front perspective view of a door for an auto-  
mobile of our new design;  
FIG. 2 is a right front perspective view thereof;  
FIG. 3 is a front elevation view thereof;  
FIG. 4 is a rear elevation view thereof;  
FIG. 5 is a top plan view thereof;  
FIG. 6 is a bottom view thereof;  
FIG. 7 is a right side view thereof; and,  
FIG. 8 is a left side view thereof.

(56) **References Cited**

**U.S. PATENT DOCUMENTS**

D647,837 S 11/2011 Kubo  
D659,619 S \* 5/2012 Hakamata et al. .... D12/196

**1 Claim, 4 Drawing Sheets**



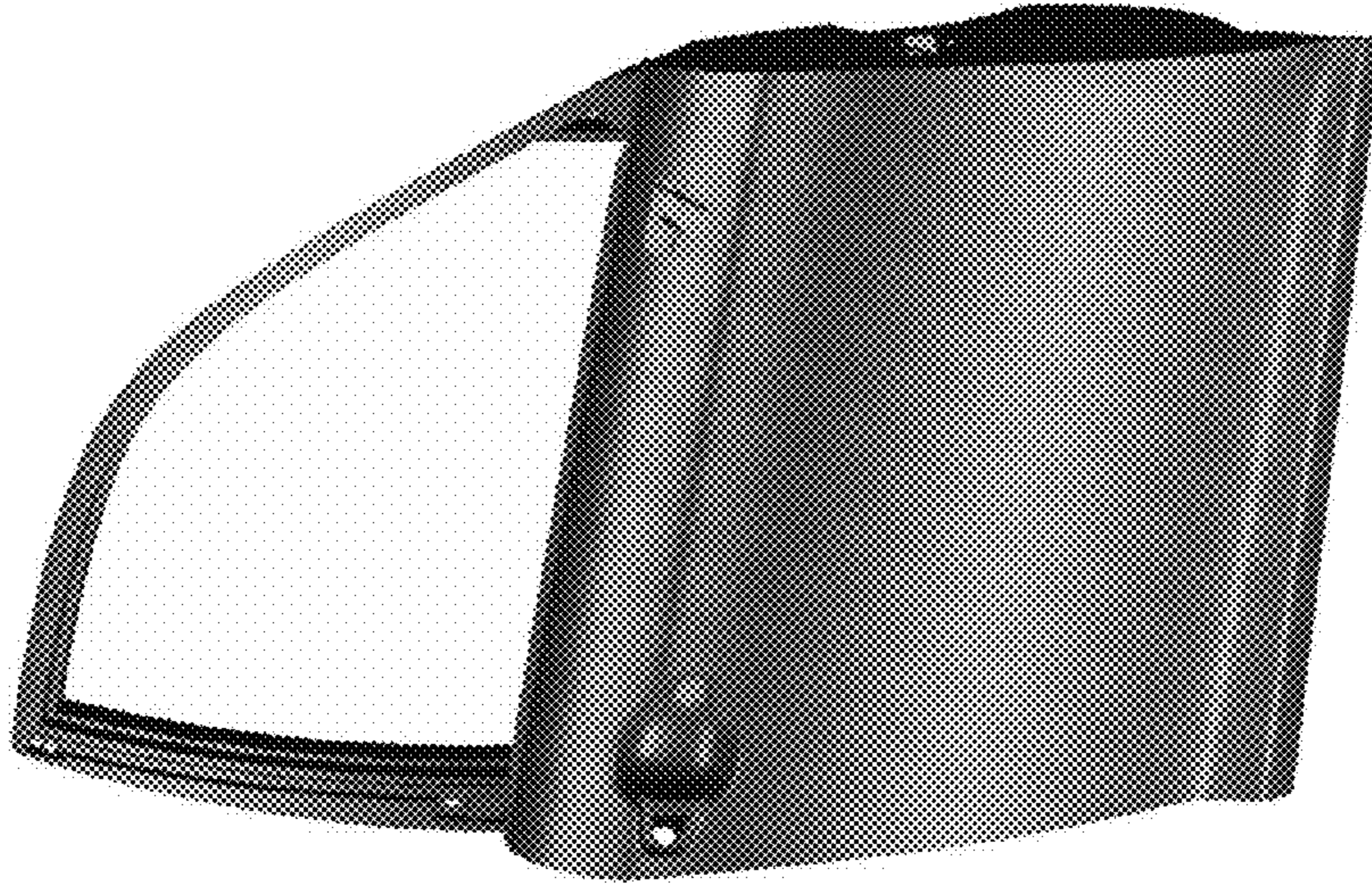

FIG. 2

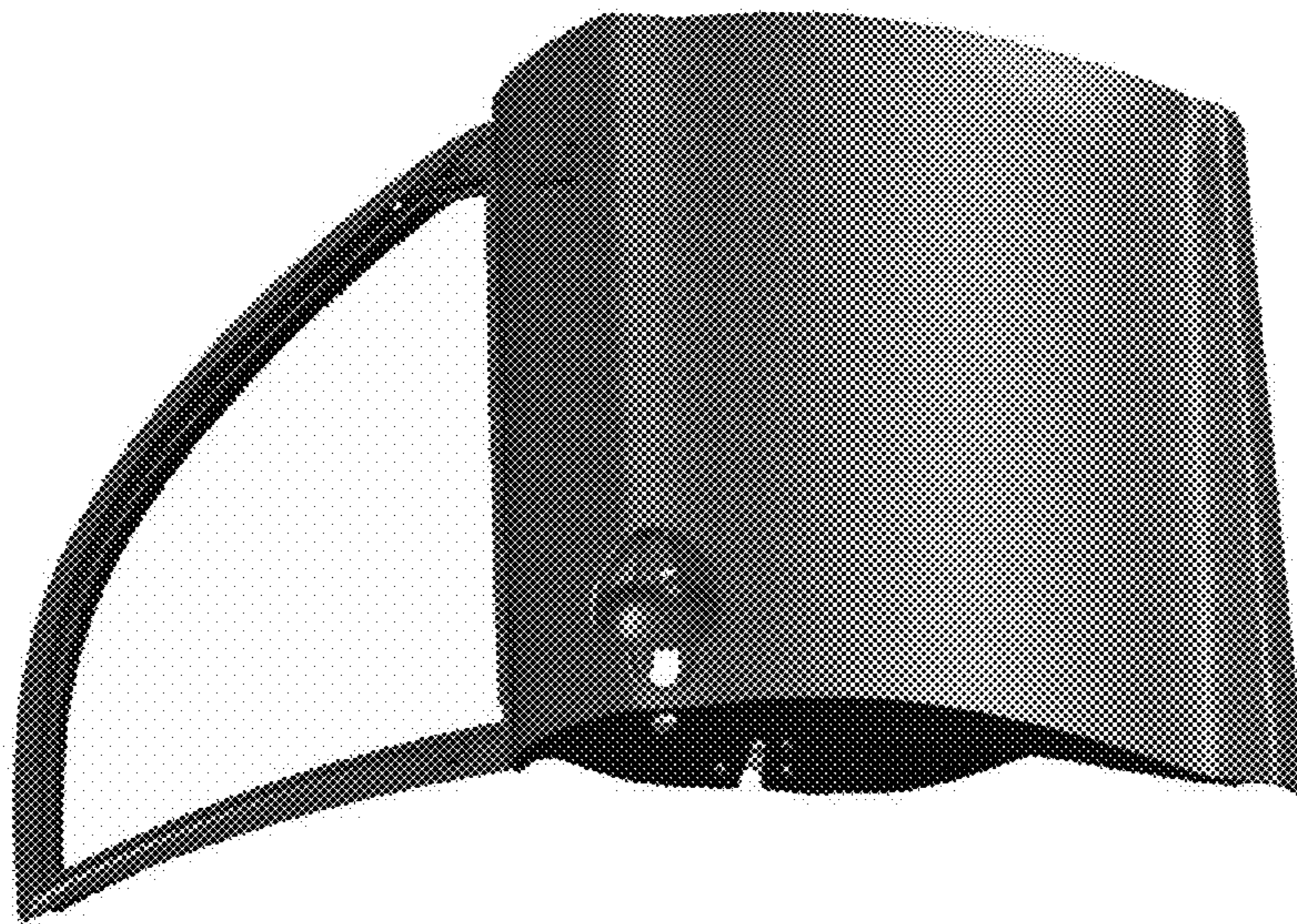

FIG. 1

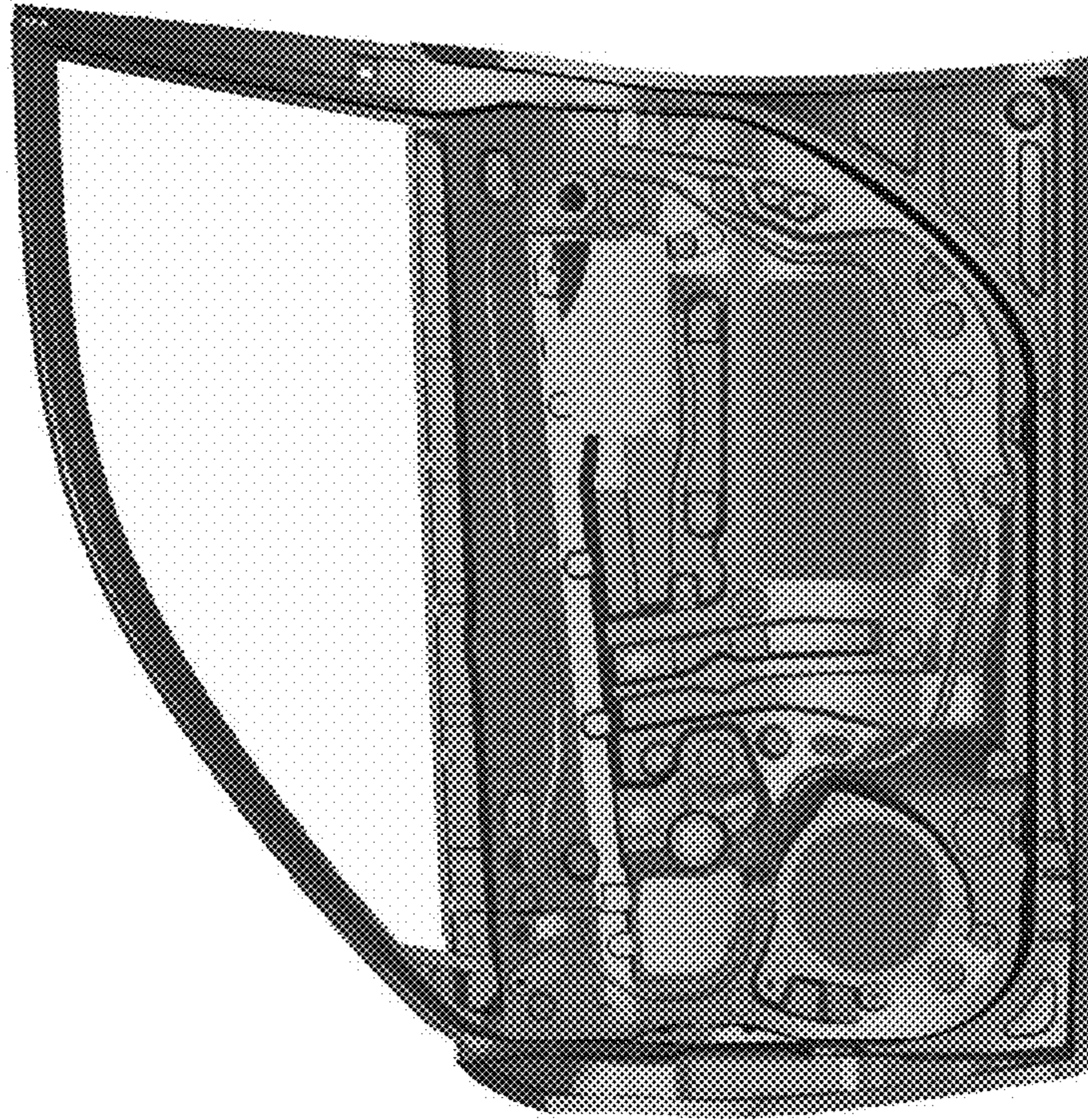

FIG. 4

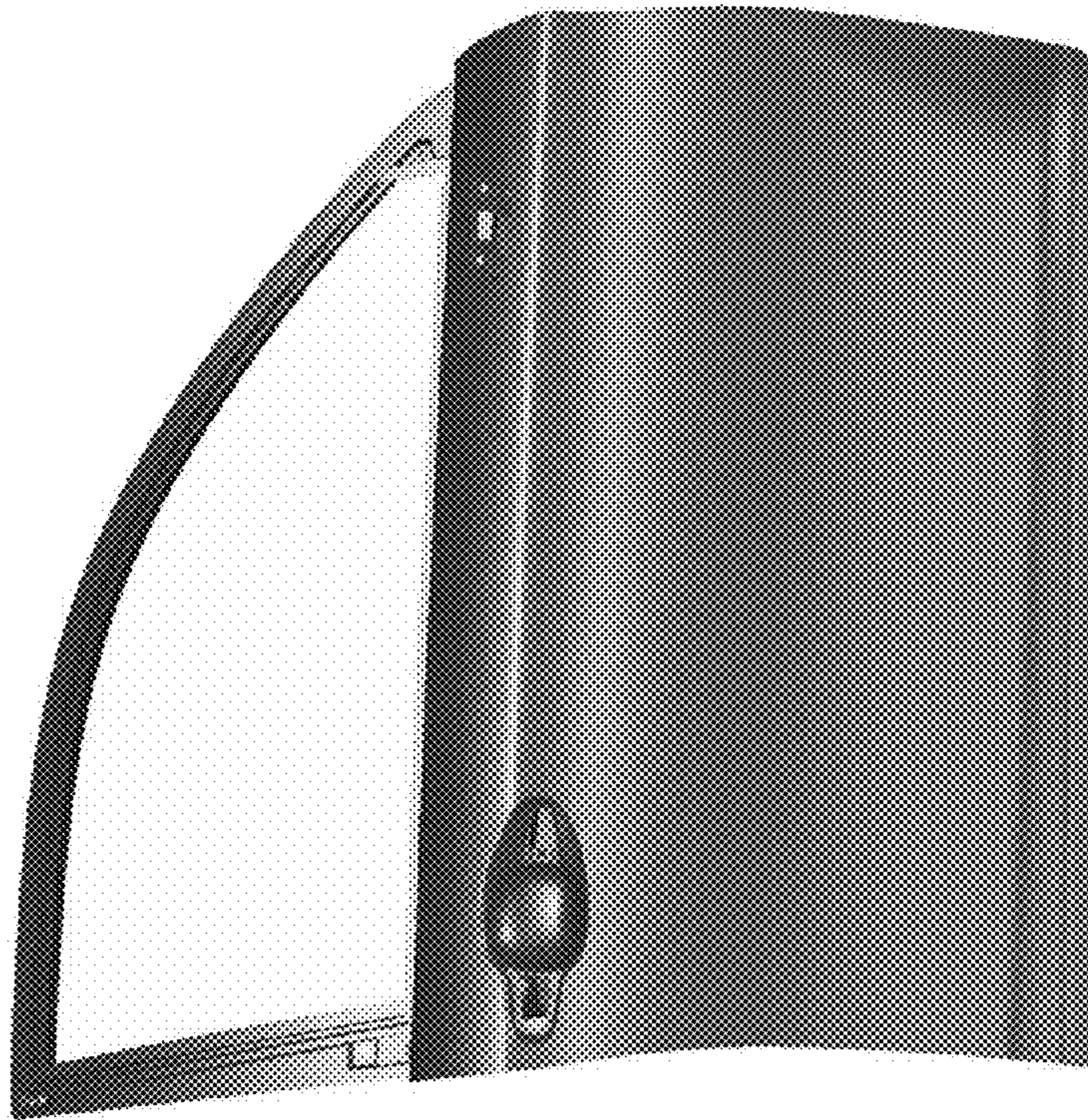

FIG. 3

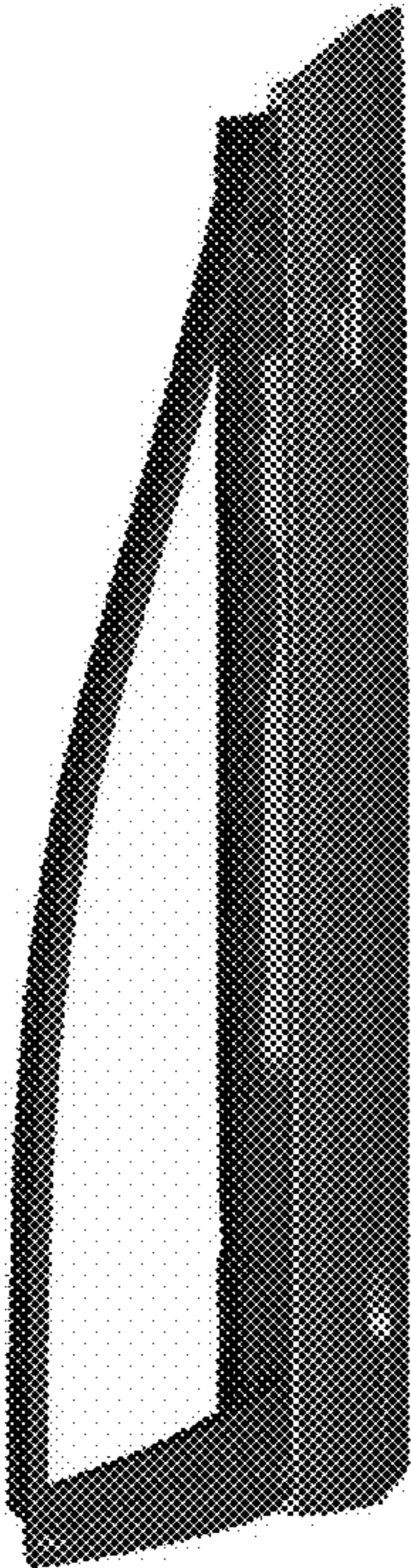

FIG. 5

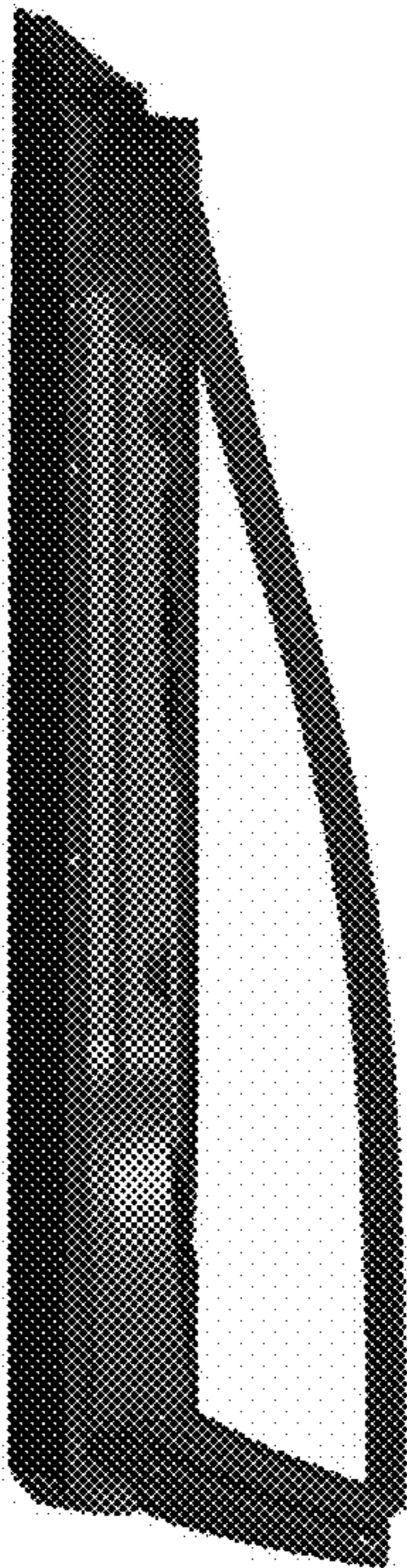
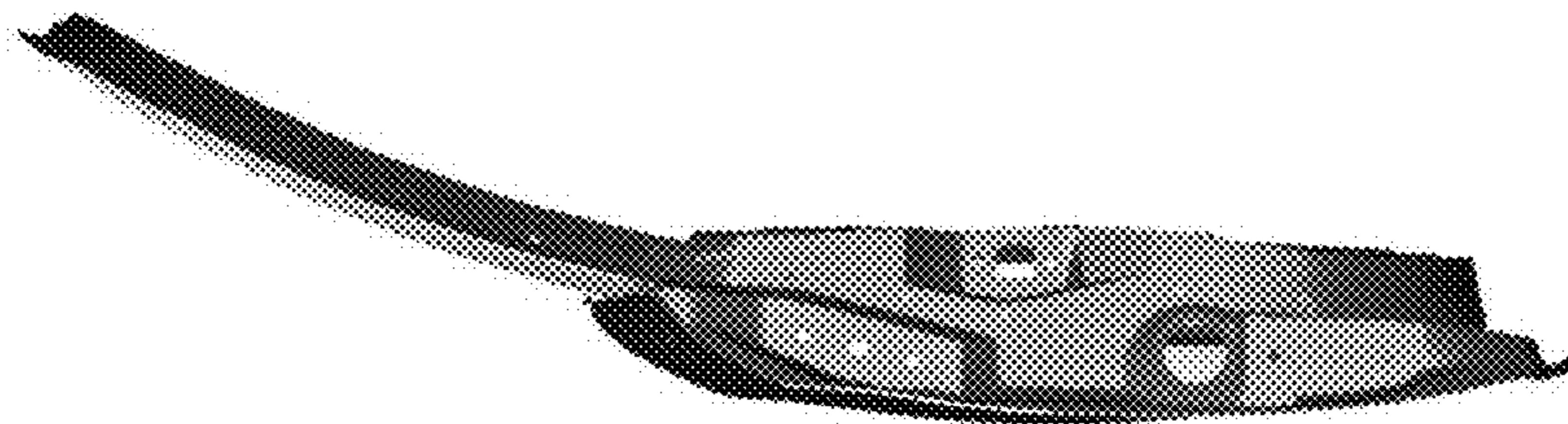

FIG. 6



**FIG. 8**



**FIG. 7**

UNITED STATES PATENT AND TRADEMARK OFFICE  
**CERTIFICATE OF CORRECTION**

PATENT NO. : D694,163 S  
APPLICATION NO. : 29/418013  
DATED : November 26, 2013  
INVENTOR(S) : Masayuki Yamada et al.

Page 1 of 1

It is certified that error appears in the above-identified patent and that said Letters Patent is hereby corrected as shown below:

On the Title Page

Under item (57) **CLAIM**

After the FIG. 8 description, insert the following language in a separate paragraph:

--Our design includes a mirror image of the embodiment depicted.--

Signed and Sealed this  
Fifth Day of August, 2014



Michelle K. Lee  
*Deputy Director of the United States Patent and Trademark Office*