



US00D694150S

(12) **United States Design Patent**
Jennings

(10) **Patent No.:** **US D694,150 S**
(45) **Date of Patent:** **** Nov. 26, 2013**

(54) **BASEBALL BAT WITH PLATE STAND**
(71) Applicant: **Robin Jennings**, Ogden, UT (US)
(72) Inventor: **Robin Jennings**, Ogden, UT (US)
(**) Term: **14 Years**
(21) Appl. No.: **29/438,088**
(22) Filed: **Nov. 26, 2012**
(51) **LOC (9) Cl.** **11-02**
(52) **U.S. Cl.**
USPC **D11/157**
(58) **Field of Classification Search**
USPC D21/725; D11/157, 117, 131, 184;
D99/25; 428/3, 13; D26/94; D6/674,
D6/303, 314, 661, 300; 206/315.1, 315.9;
D20/10
See application file for complete search history.

(56) **References Cited**

U.S. PATENT DOCUMENTS

D226,091 S * 1/1973 Brack D11/157
(Continued)

Primary Examiner — Mitchell Siegel

(74) *Attorney, Agent, or Firm* — Dentons US LLP; Adam C. Rehm

(57) **CLAIM**

The ornamental design for a baseball bat with plate stand, as shown and described.

DESCRIPTION

FIG. 1 is a perspective view of a baseball bat with plate stand showing a new design;
FIG. 2 is a left side view of the baseball bat with plate stand shown in FIG. 1, the right side view being a mirror image of the left side view;
FIG. 3 is a front view of the baseball bat with plate stand shown in FIG. 1;
FIG. 4 is a rear view of the baseball bat with plate stand shown in FIG. 1;

FIG. 5 is a top plan view of the baseball bat with plate stand shown in FIG. 1;
FIG. 6 is a bottom view of the baseball bat with plate stand shown in FIG. 1;
FIG. 7 is a perspective view of a second embodiment of a baseball bat with plate stand;
FIG. 8 is a left side view of the baseball bat with plate stand shown in FIG. 7, the right side view being a mirror image of the left side view;
FIG. 9 is a front view of the baseball bat with plate stand shown in FIG. 7;
FIG. 10 is a rear view of the baseball bat with plate stand shown in FIG. 7;
FIG. 11 is a top plan view of the baseball bat with plate stand shown in FIG. 7;
FIG. 12 is a bottom view of the baseball bat with plate stand shown in FIG. 7;
FIG. 13 is a perspective view of a third embodiment of a baseball bat with plate stand;
FIG. 14 is a left side view of the baseball bat with plate stand shown in FIG. 13, the right side view being a mirror image of the left side view;
FIG. 15 is a front view of the baseball bat with plate stand shown in FIG. 13;
FIG. 16 is a rear view of the baseball bat with plate stand shown in FIG. 13;
FIG. 17 is a top plan view of the baseball bat with plate stand shown in FIG. 13;
FIG. 18 is a bottom view of the baseball bat with plate stand shown in FIG. 13;
FIG. 19 is a perspective view of a fourth embodiment of a baseball bat with plate stand;
FIG. 20 is a left side view of the baseball bat with plate stand shown in FIG. 19, the right side view being a mirror image of the left side view;
FIG. 21 is a front view of the baseball bat with plate stand shown in FIG. 19;
FIG. 22 is a rear view of the baseball bat with plate stand shown in FIG. 19;
FIG. 23 is a top plan view of the baseball bat with plate stand shown in FIG. 19; and,
FIG. 24 is a bottom view of the baseball bat with plate stand shown in FIG. 19.

1 Claim, 20 Drawing Sheets

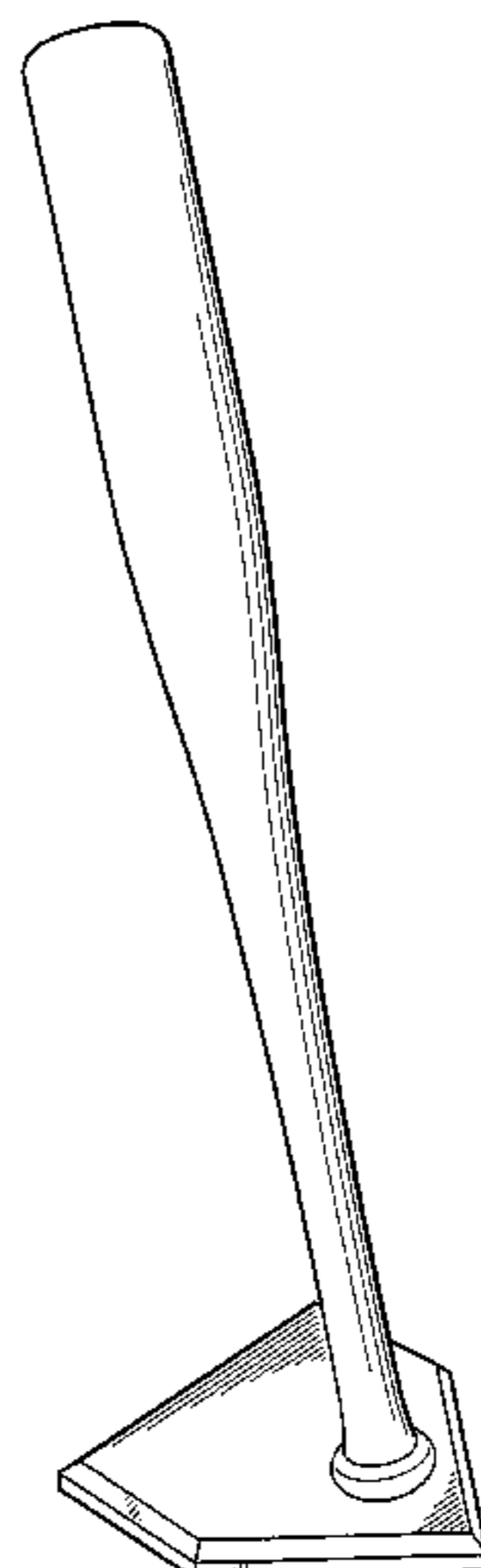

(56)

References Cited

U.S. PATENT DOCUMENTS

D255,679 S * 7/1980 Thomas D14/143
D285,393 S * 9/1986 Miller D6/412
D292,617 S * 11/1987 Werth D26/94
5,365,683 A * 11/1994 Borja 40/781
D356,387 S * 3/1995 Schwartz D26/94
D360,272 S * 7/1995 Chur D26/94

D368,975 S * 4/1996 Schwartz D26/94
D371,911 S * 7/1996 Peterson et al. D6/303
D380,906 S * 7/1997 White D6/303
D387,465 S * 12/1997 Copland et al. D26/94
6,016,910 A * 1/2000 Rodearmel 206/315.9
D472,845 S * 4/2003 Thompson D11/157
D620,186 S * 7/2010 Henson D26/94
2008/0099354 A1 * 5/2008 Pelta 206/315.1

* cited by examiner

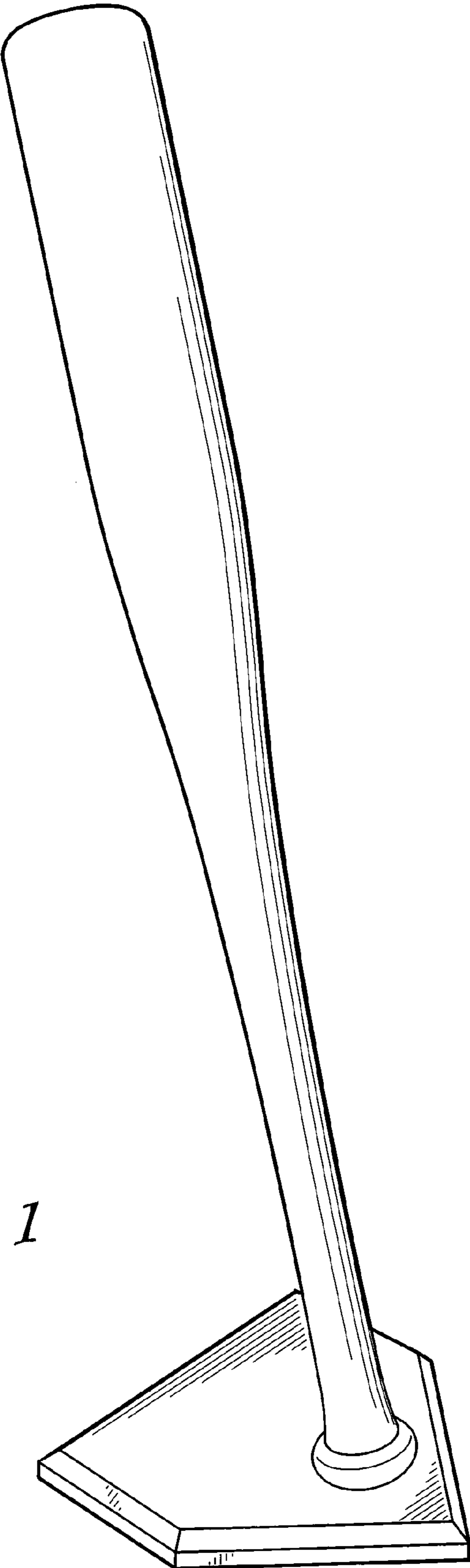

Fig. 1

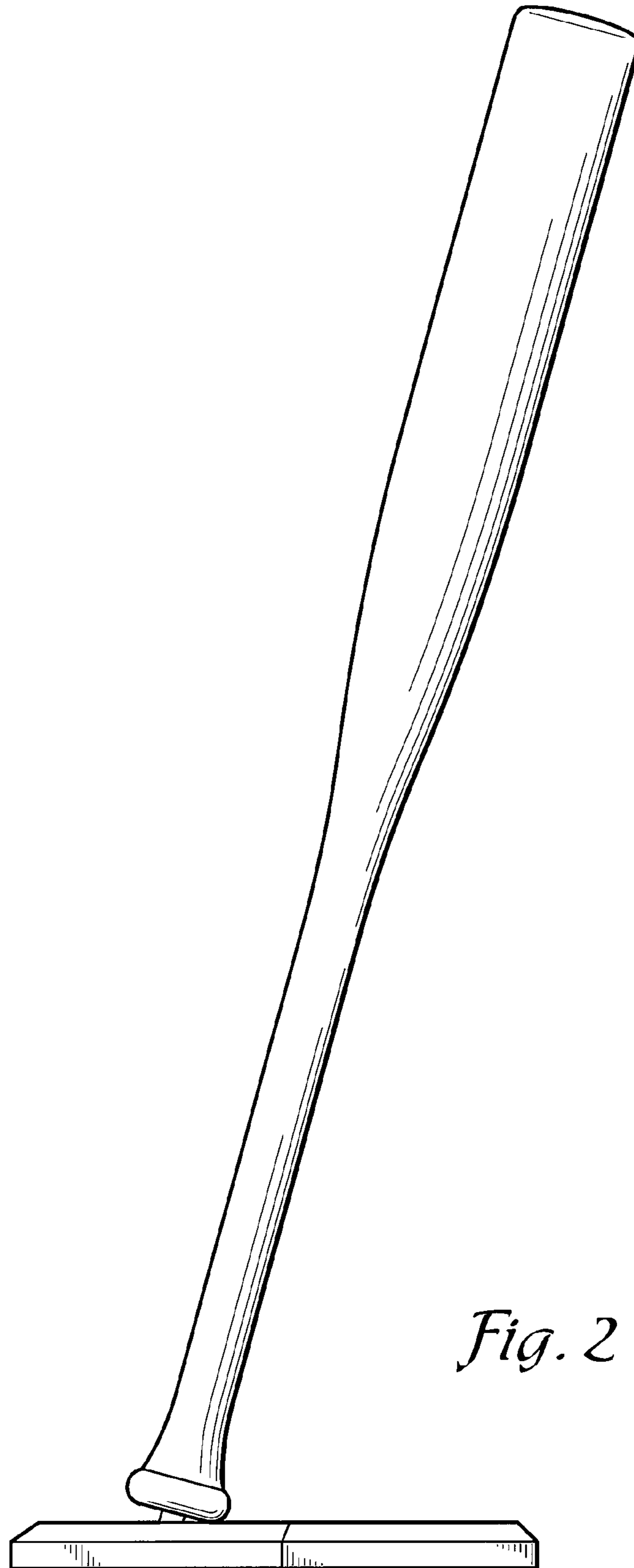

Fig. 2

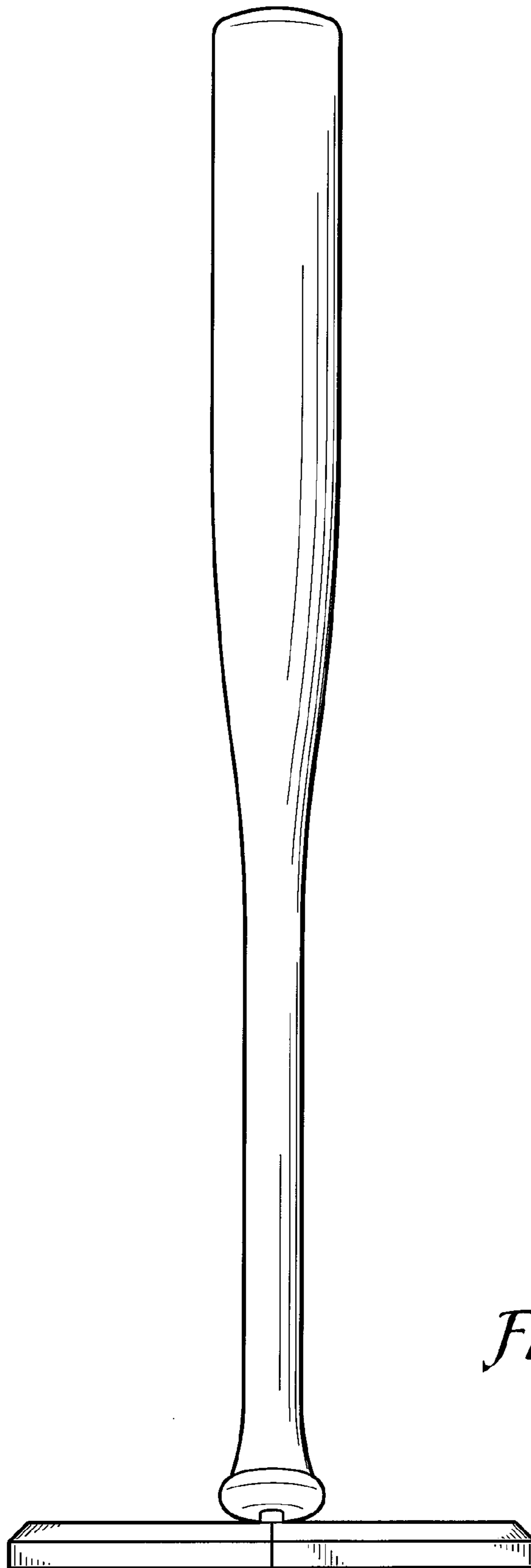

Fig. 3

Fig. 4



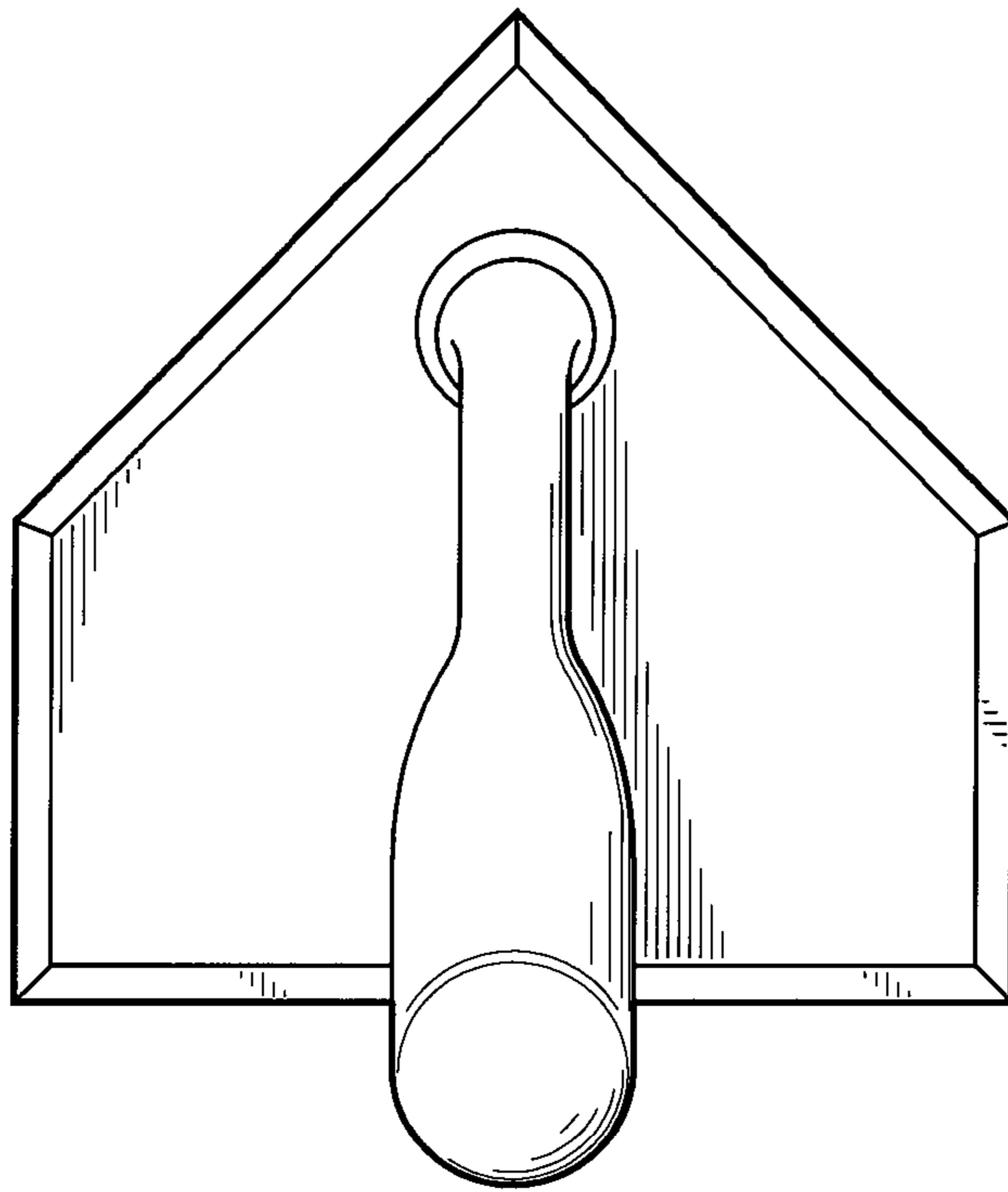

Fig. 5

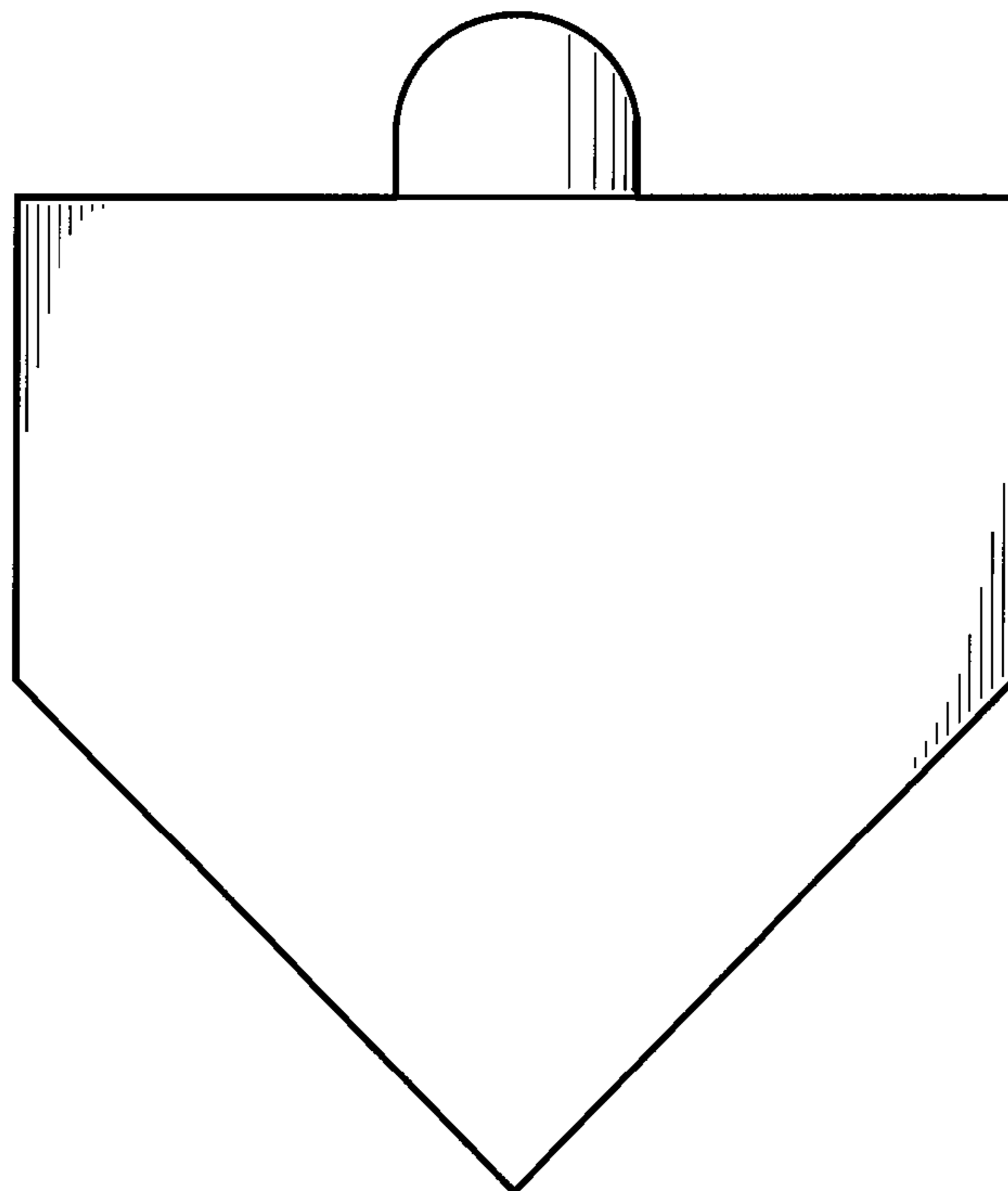

Fig. 6

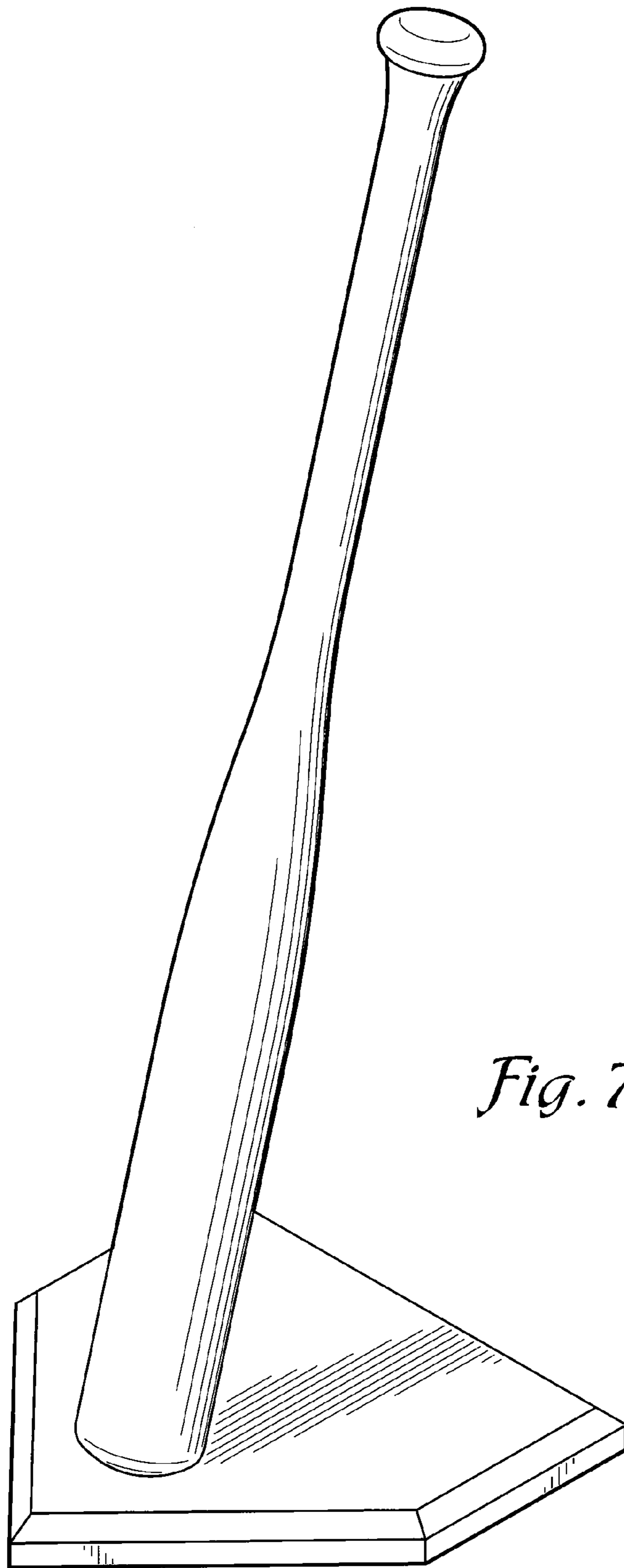

Fig. 7

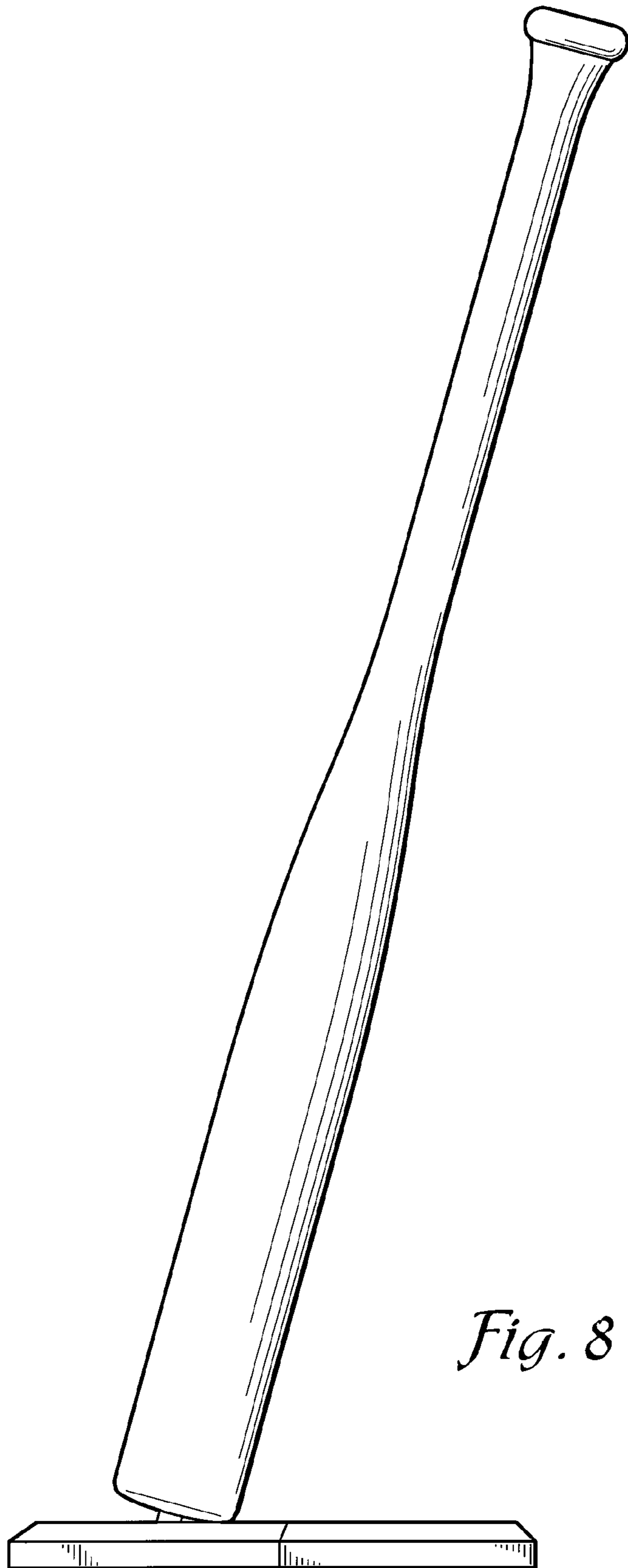

Fig. 8



Fig. 9



Fig. 10

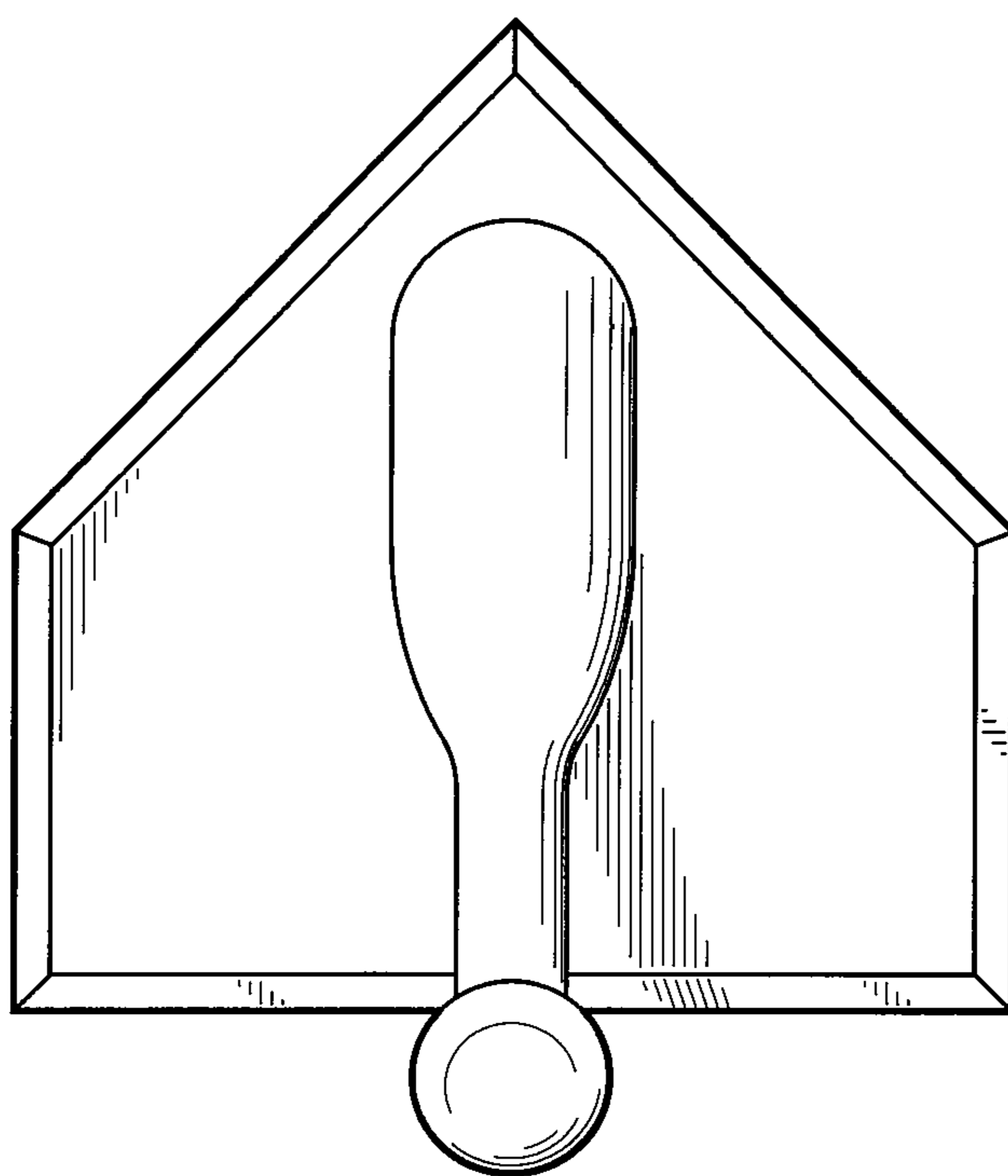

Fig. 11

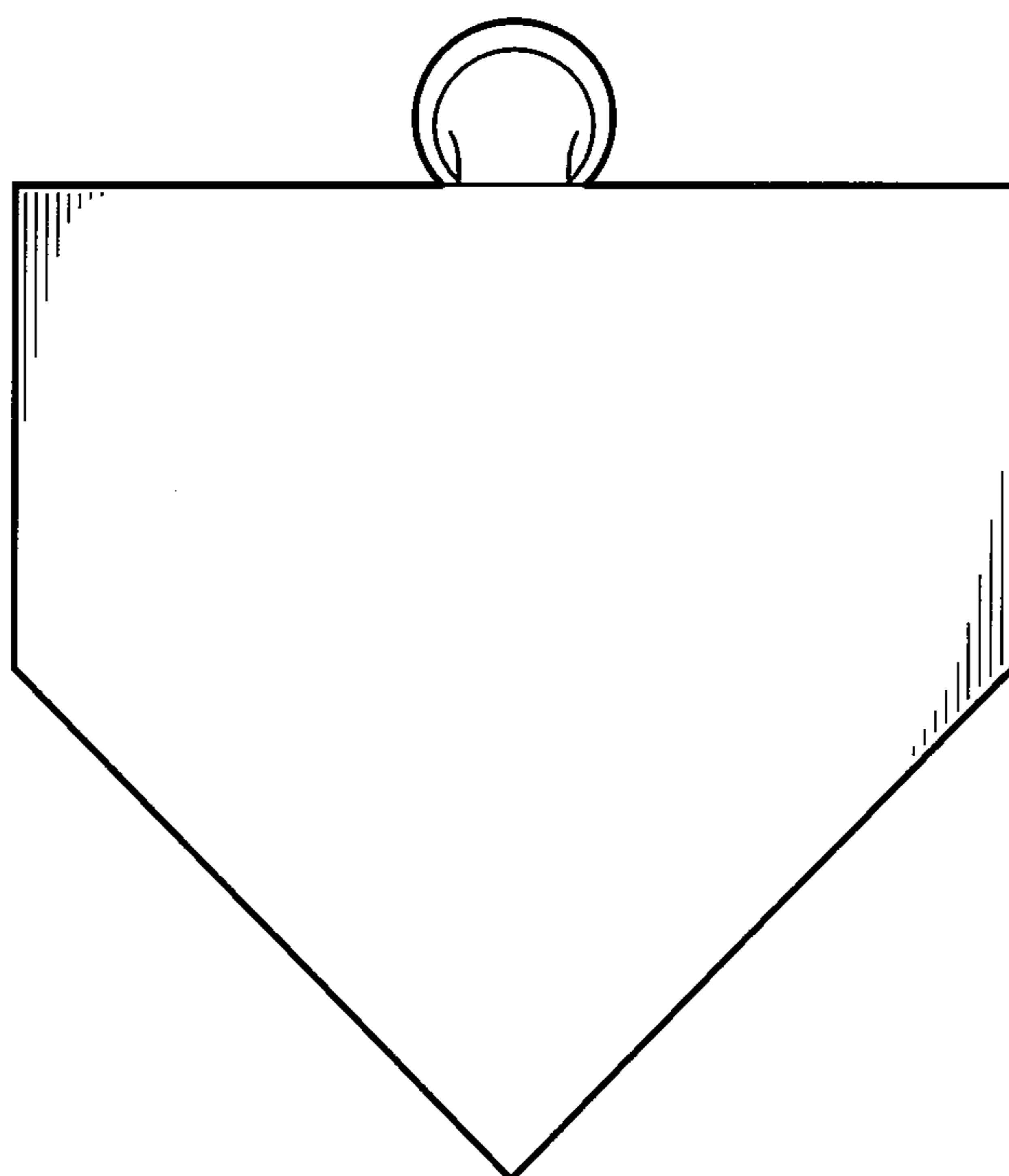

Fig. 12

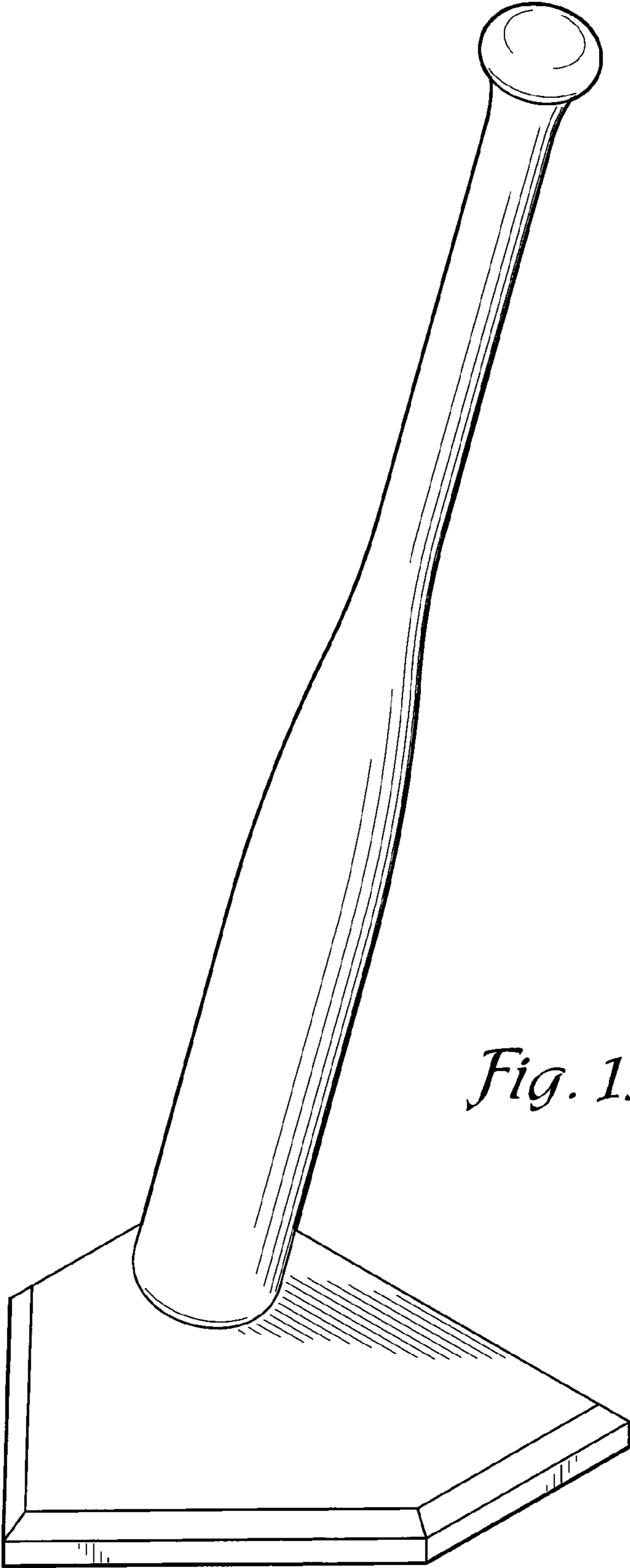

Fig. 13



Fig. 14

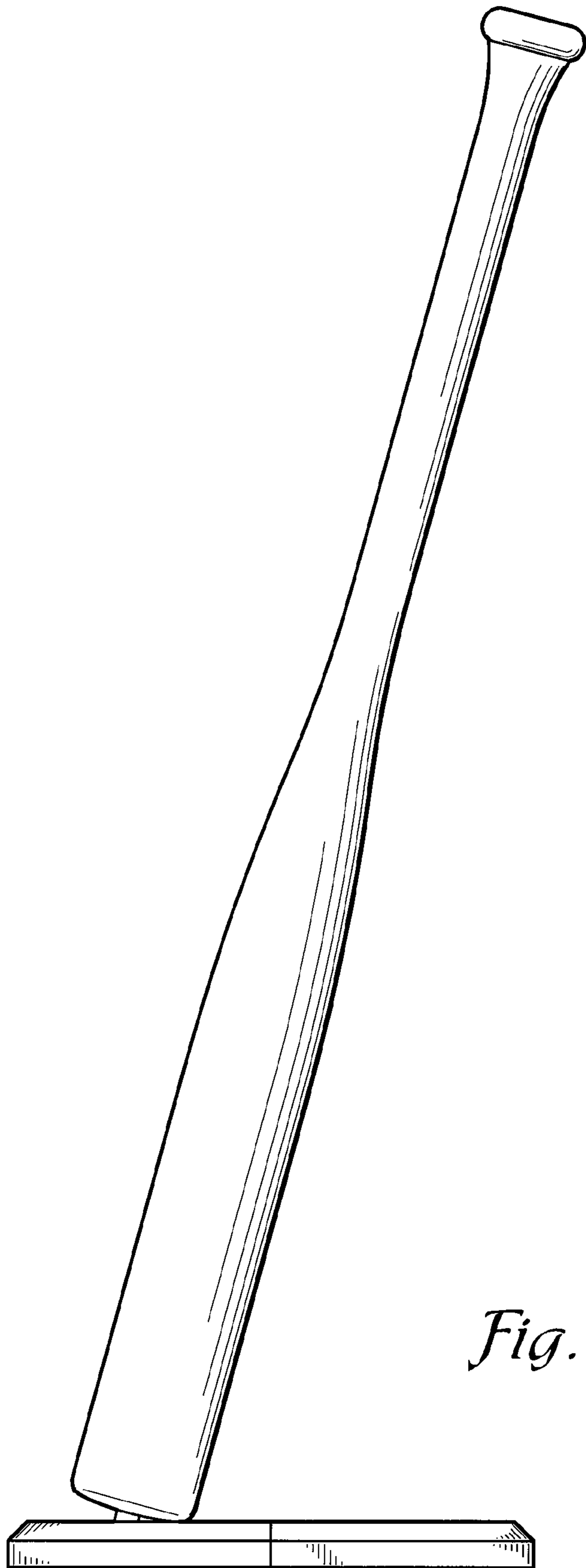

Fig. 15

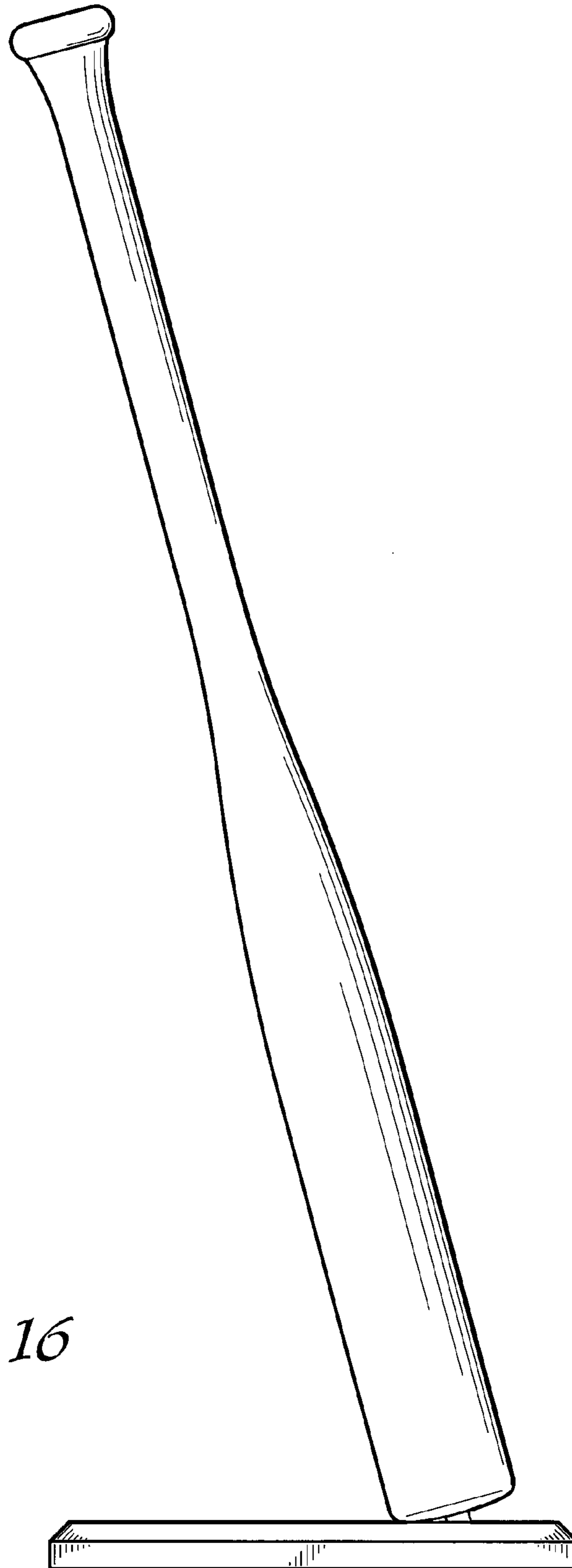

Fig. 16

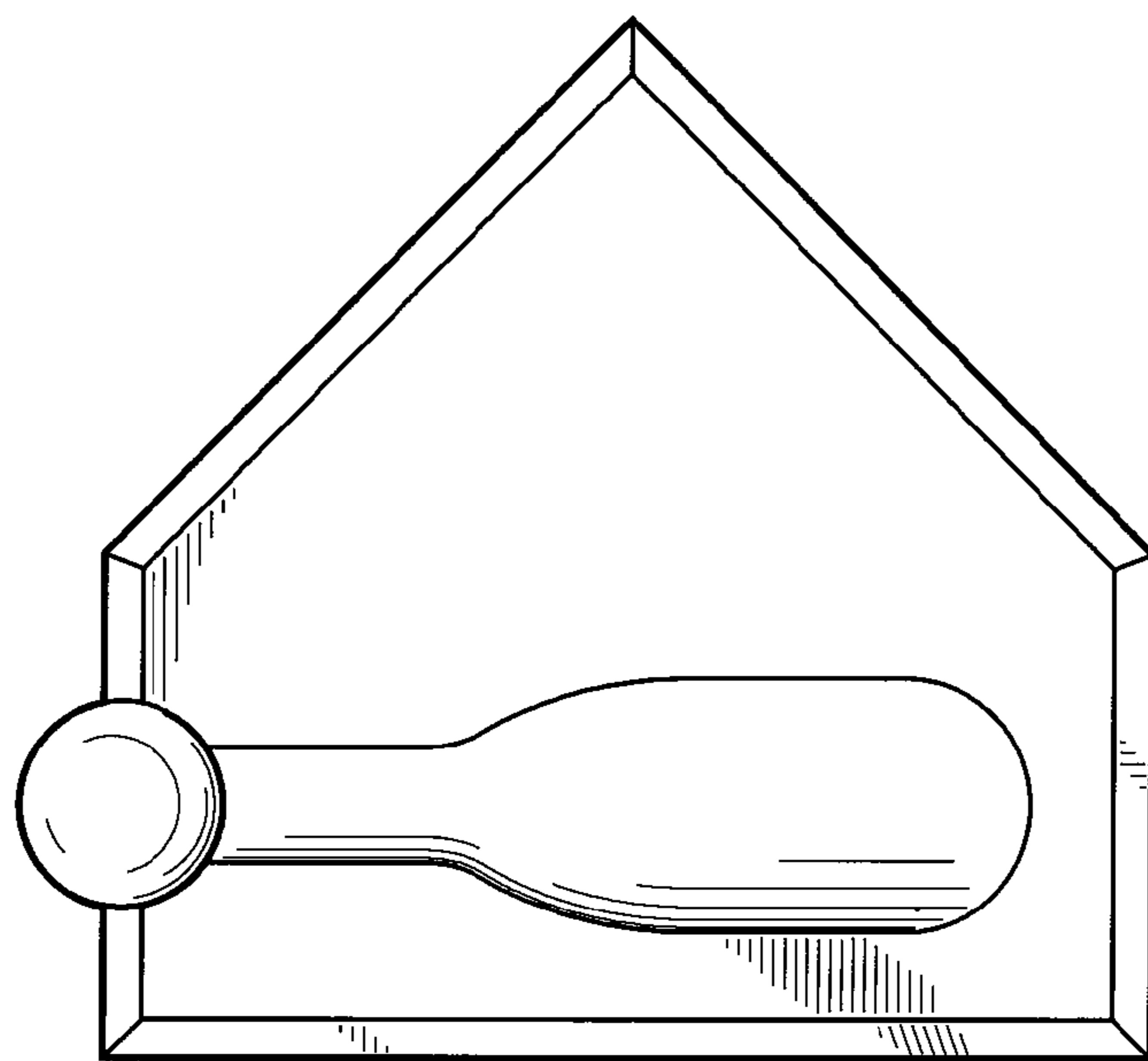

Fig. 17

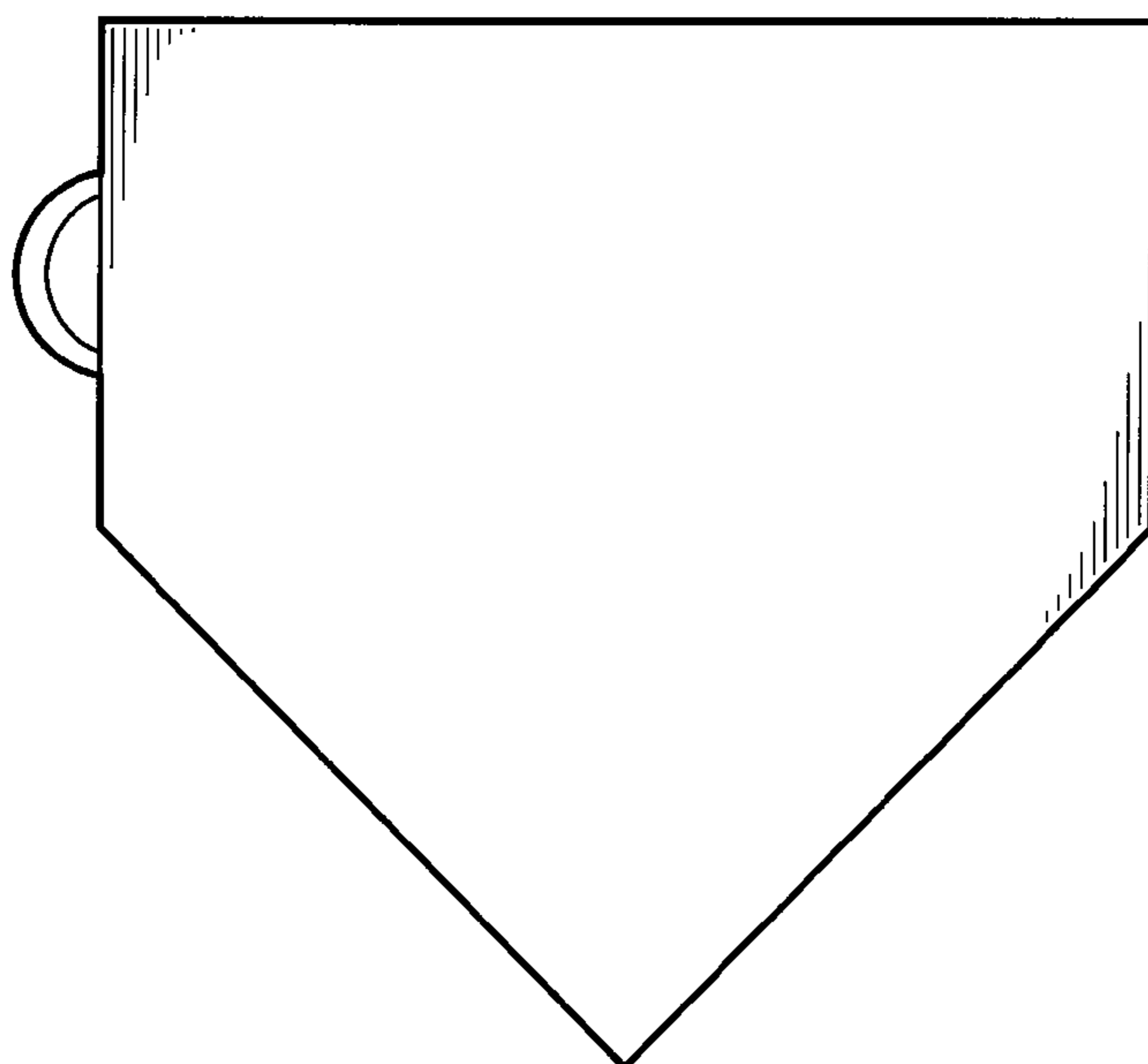

Fig. 18

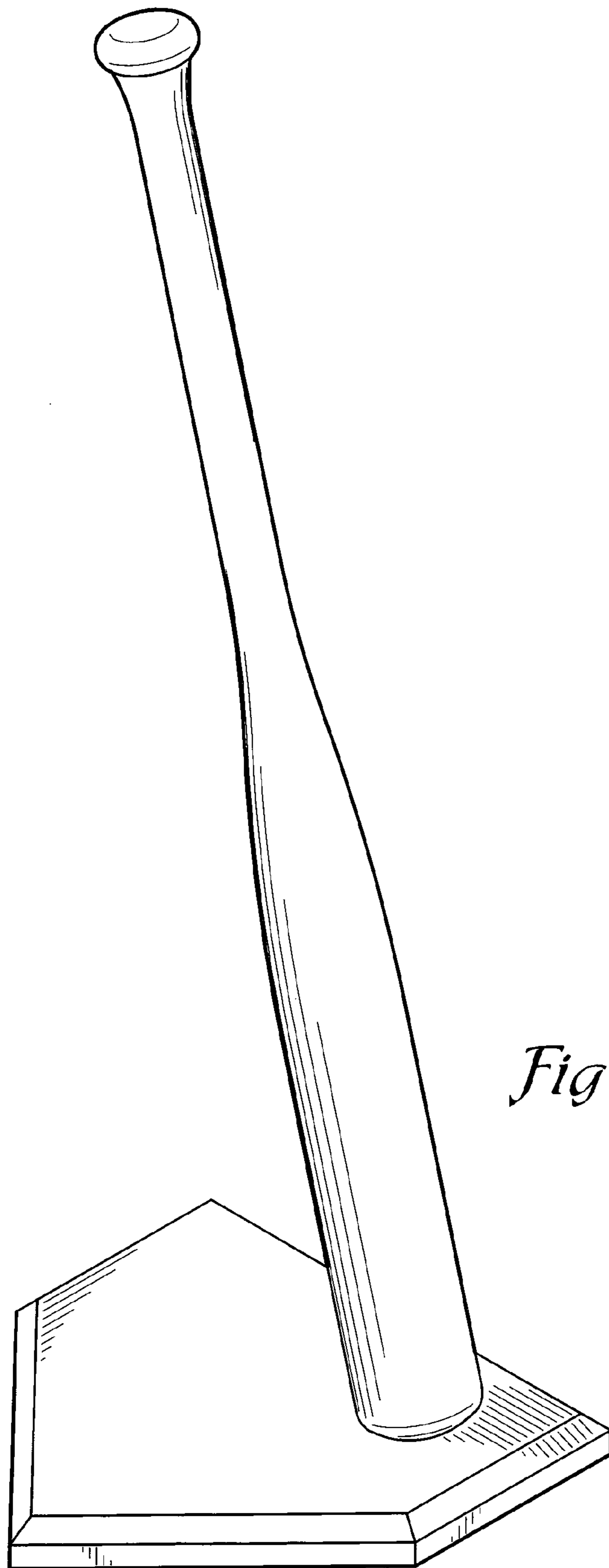

Fig. 19



Fig. 20

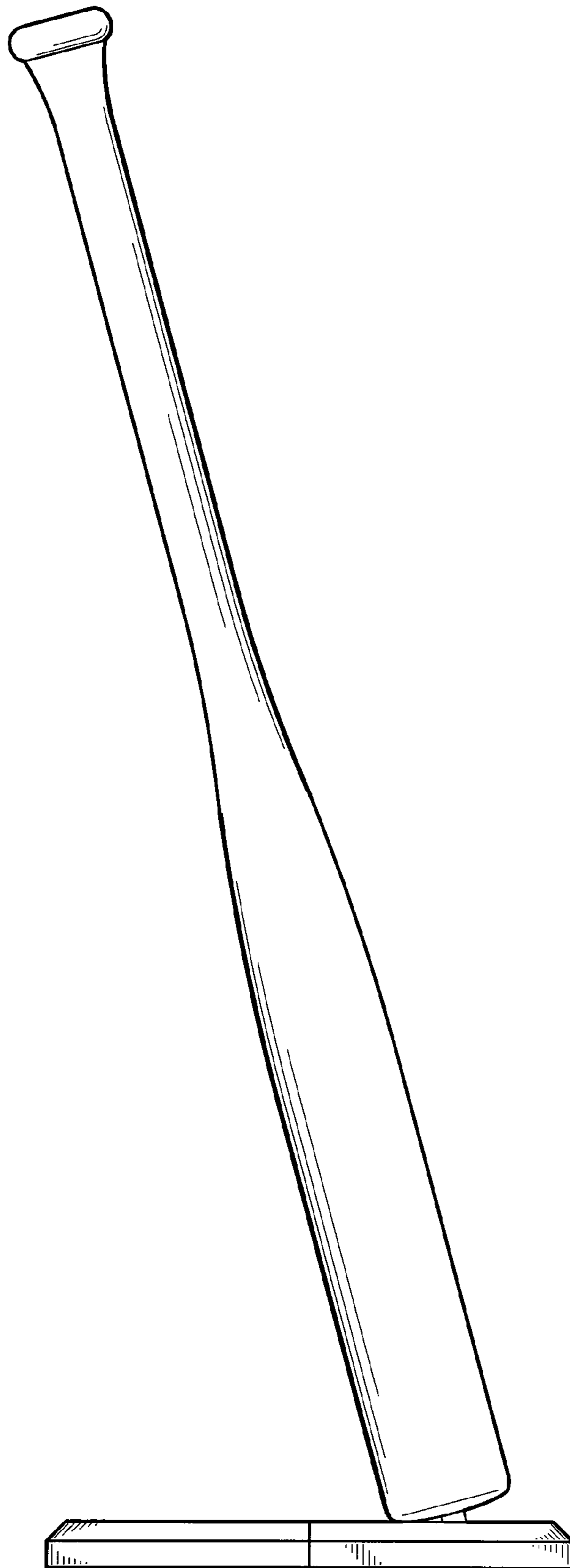
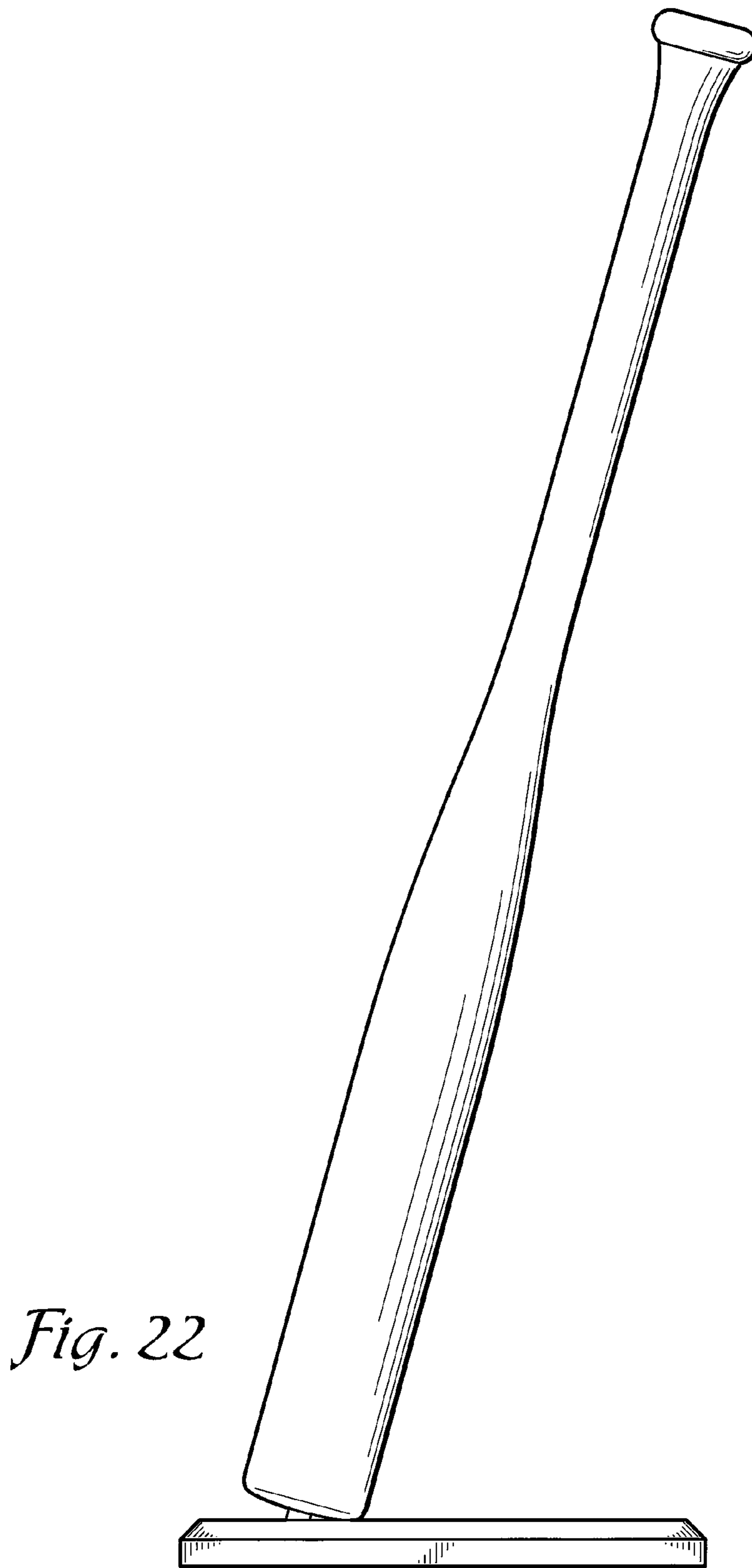

Fig. 21



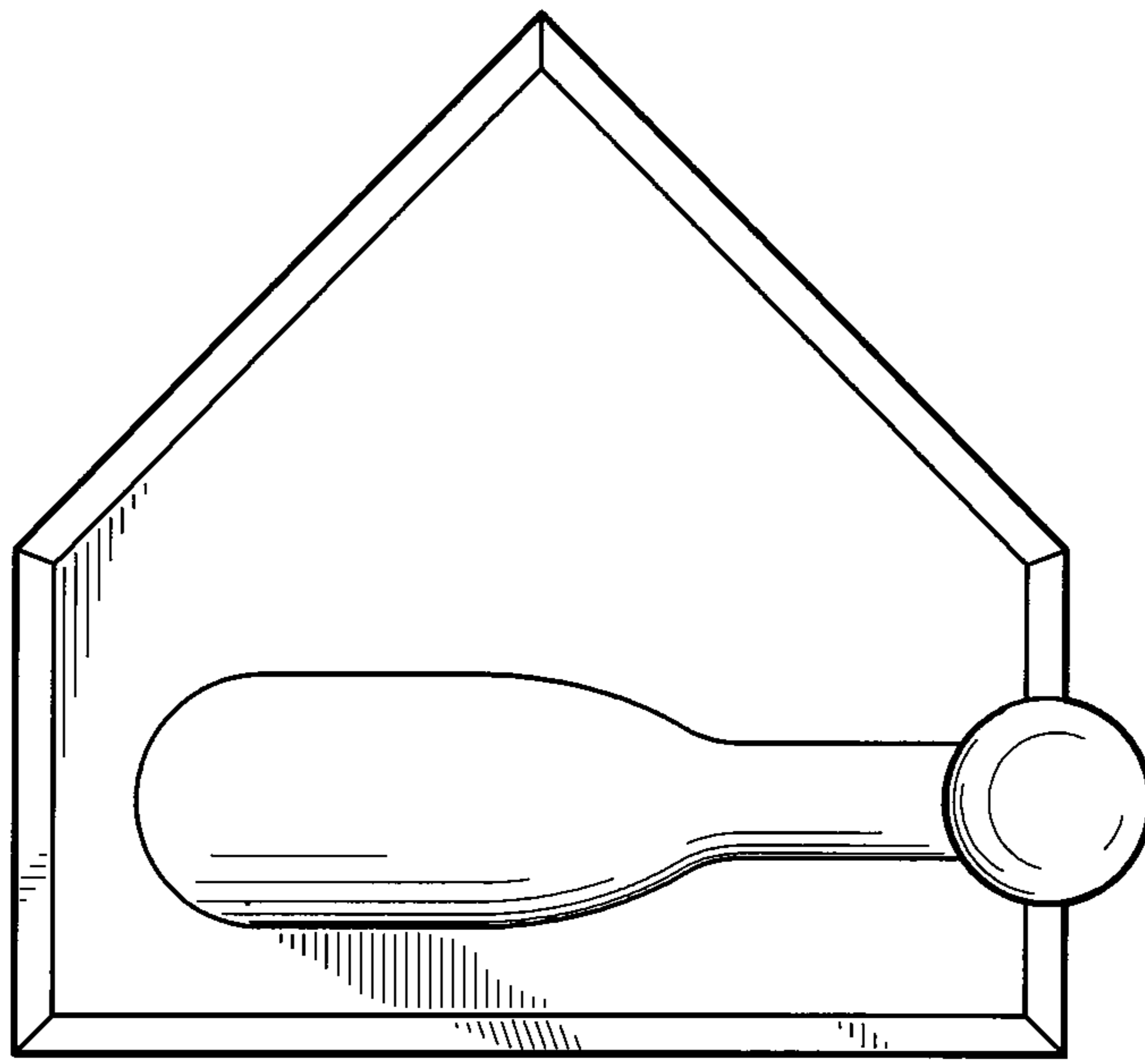

Fig. 23

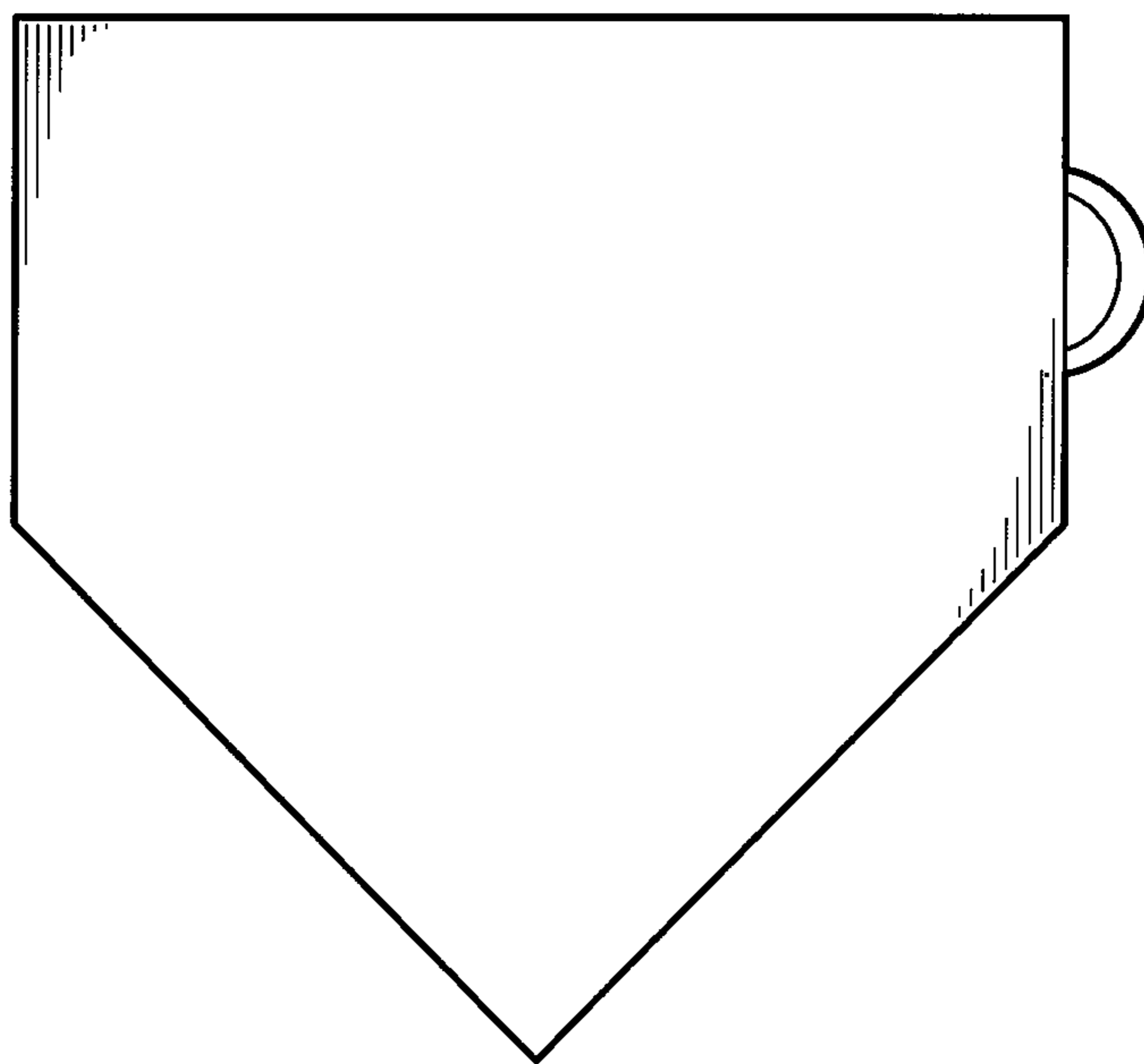

Fig. 24