

US00D694130S

(12) **United States Design Patent**
Manneschi

(10) **Patent No.:** **US D694,130 S**

(45) **Date of Patent:** **** Nov. 26, 2013**

(54) **PORTABLE METAL DETECTOR**

2013/0021192 A1* 1/2013 Daly 342/22

* cited by examiner

(75) Inventor: **Alessandro Manneschi, Arezzo (IT)**

Primary Examiner — Antoine D Davis

(73) Assignee: **Costruzioni Elettroniche Industrial
Automatismi S.p.A. C.E.I.A. S.p.A,**
Frazione Viciomaggio (IT)

(74) *Attorney, Agent, or Firm* — Stites & Harbison PLLC;
Douglas E. Jackson

(**) Term: **14 Years**

(57) **CLAIM**

The ornamental design for a portable metal detector, as shown
and described.

(21) Appl. No.: **29/431,385**

DESCRIPTION

(22) Filed: **Sep. 6, 2012**

FIG. 1 is a rear view of a portable metal detector showing the
new design.

(51) **LOC (9) Cl.** **10-04**

FIG. 2 is a front view thereof.

(52) **U.S. Cl.**

FIG. 3 is a bottom view thereof.

USPC **D10/47**

FIG. 4 is a top view thereof.

(58) **Field of Classification Search**

FIG. 5 is a right side view thereof.

USPC D10/47, 78; 250/336.1, 342, 504 H,
250/504 R; 324/67, 228, 232, 329, 326;
342/22, 52, 53, 459

FIG. 6 is left side view thereof.

See application file for complete search history.

FIG. 7 is a front, top and right side perspective view thereof.

FIG. 8 is a rear view of a second embodiment of a portable
metal detector showing the new design.

FIG. 9 is a front view thereof.

(56) **References Cited**

U.S. PATENT DOCUMENTS

D497,559 S *	10/2004	Johnson	D10/47
D513,706 S *	1/2006	Johnson	D10/47
D583,261 S *	12/2008	Johnson et al.	D10/47
D614,981 S *	5/2010	Junes	D10/70
D663,634 S *	7/2012	Townsend	D10/47
8,330,106 B2 *	12/2012	Green et al.	250/336.1

FIG. 10 is a bottom view thereof.

FIG. 11 is a top view thereof.

FIG. 12 is a right side view thereof.

FIG. 13 is left side view thereof; and,

FIG. 14 is a front, top and right side perspective view thereof.

In the drawings, the broken lines in FIGS. 1-14 depict por-
tions of a battery charger that form no part of the claimed
design.

1 Claim, 14 Drawing Sheets

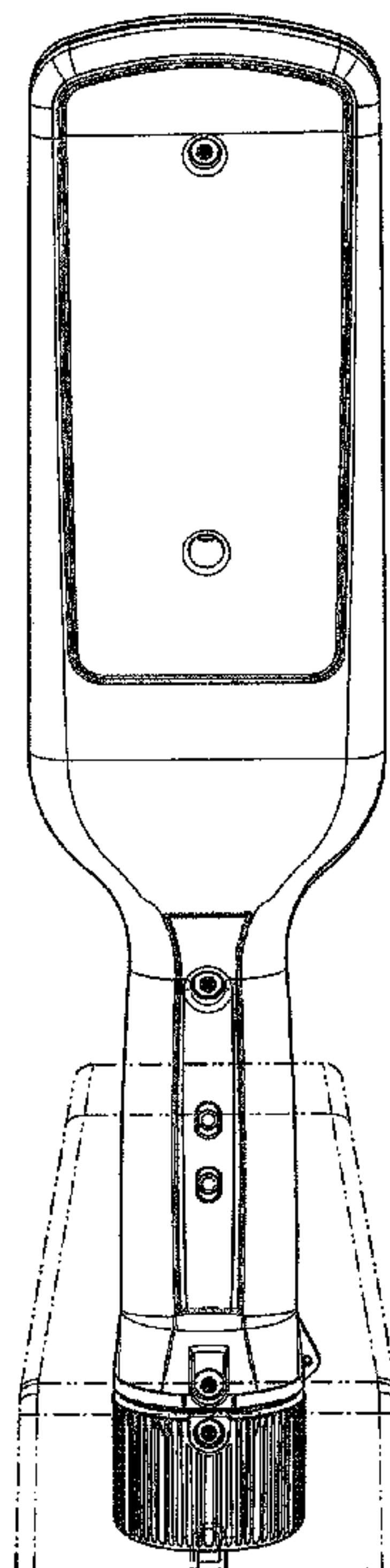

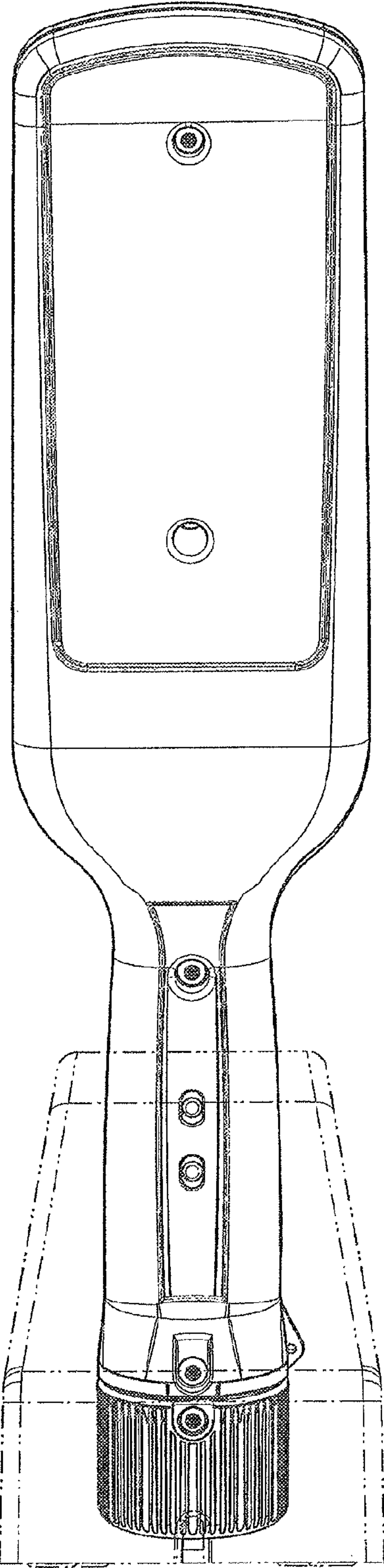

FIG. 1

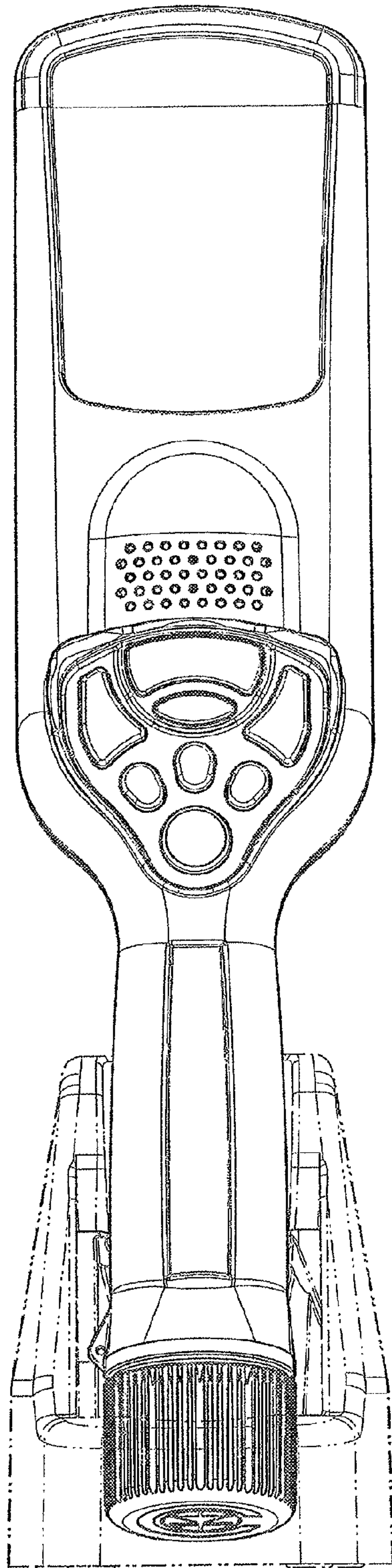

FIG. 2

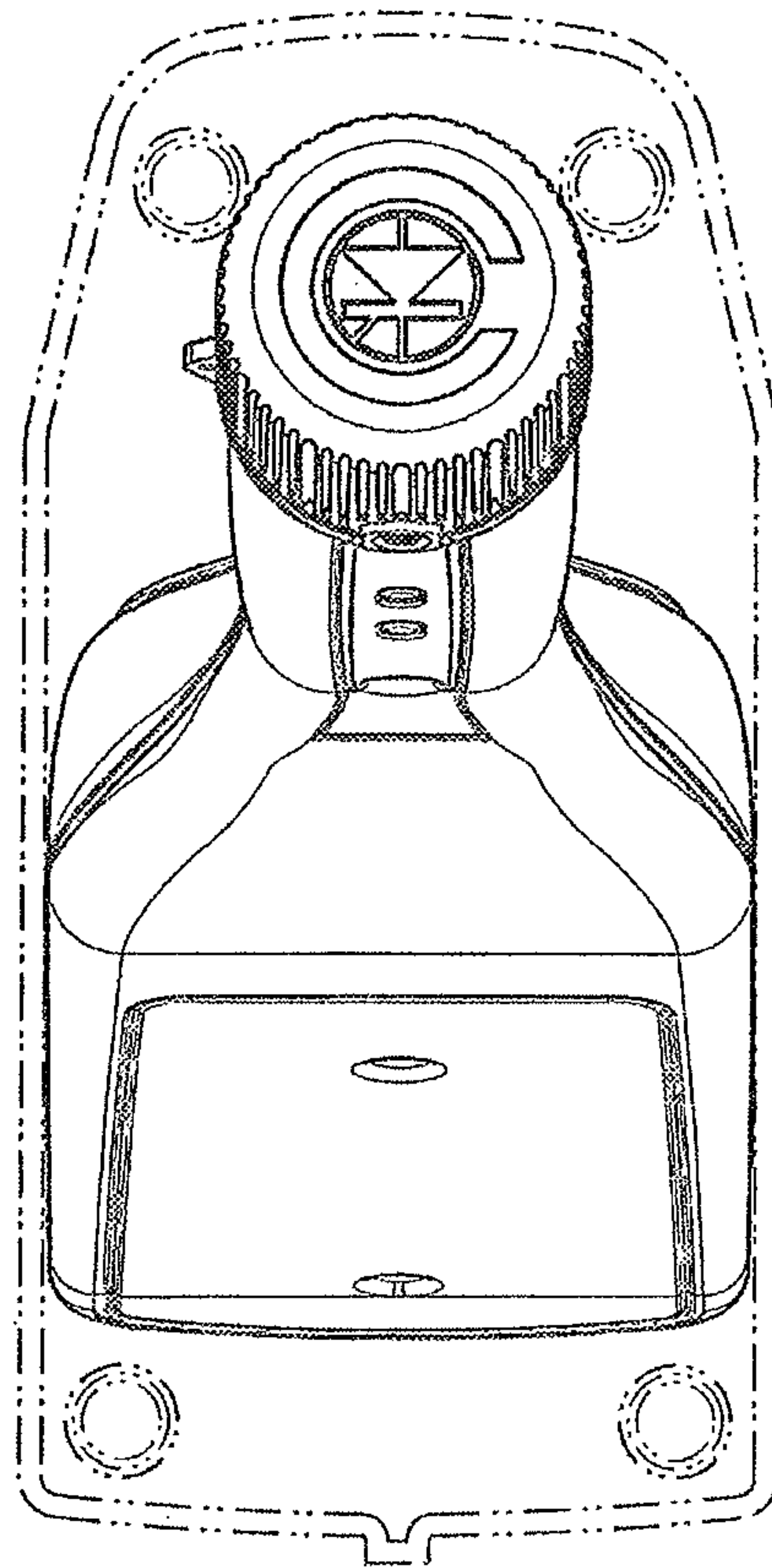

FIG. 3

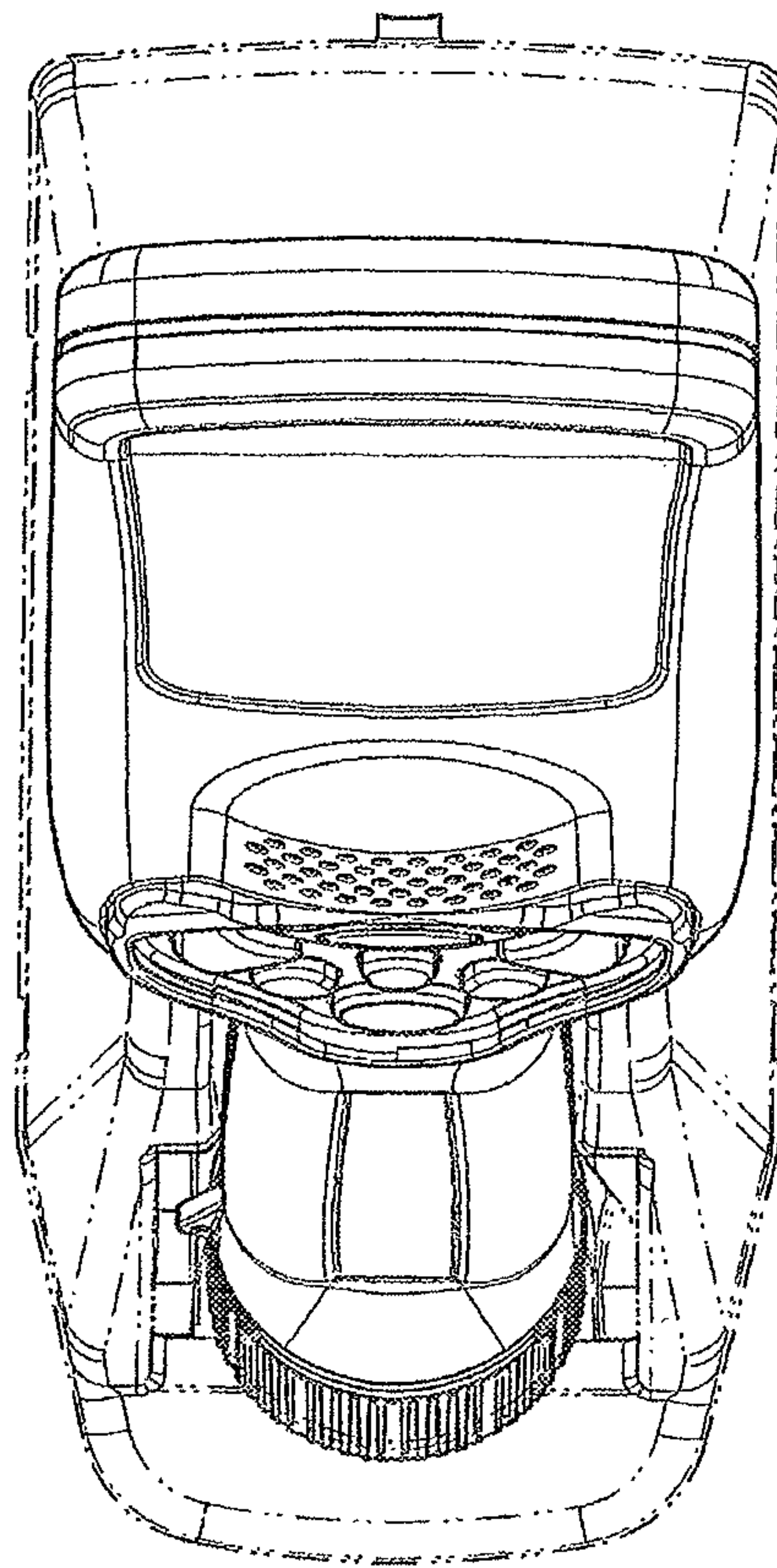

FIG. 4

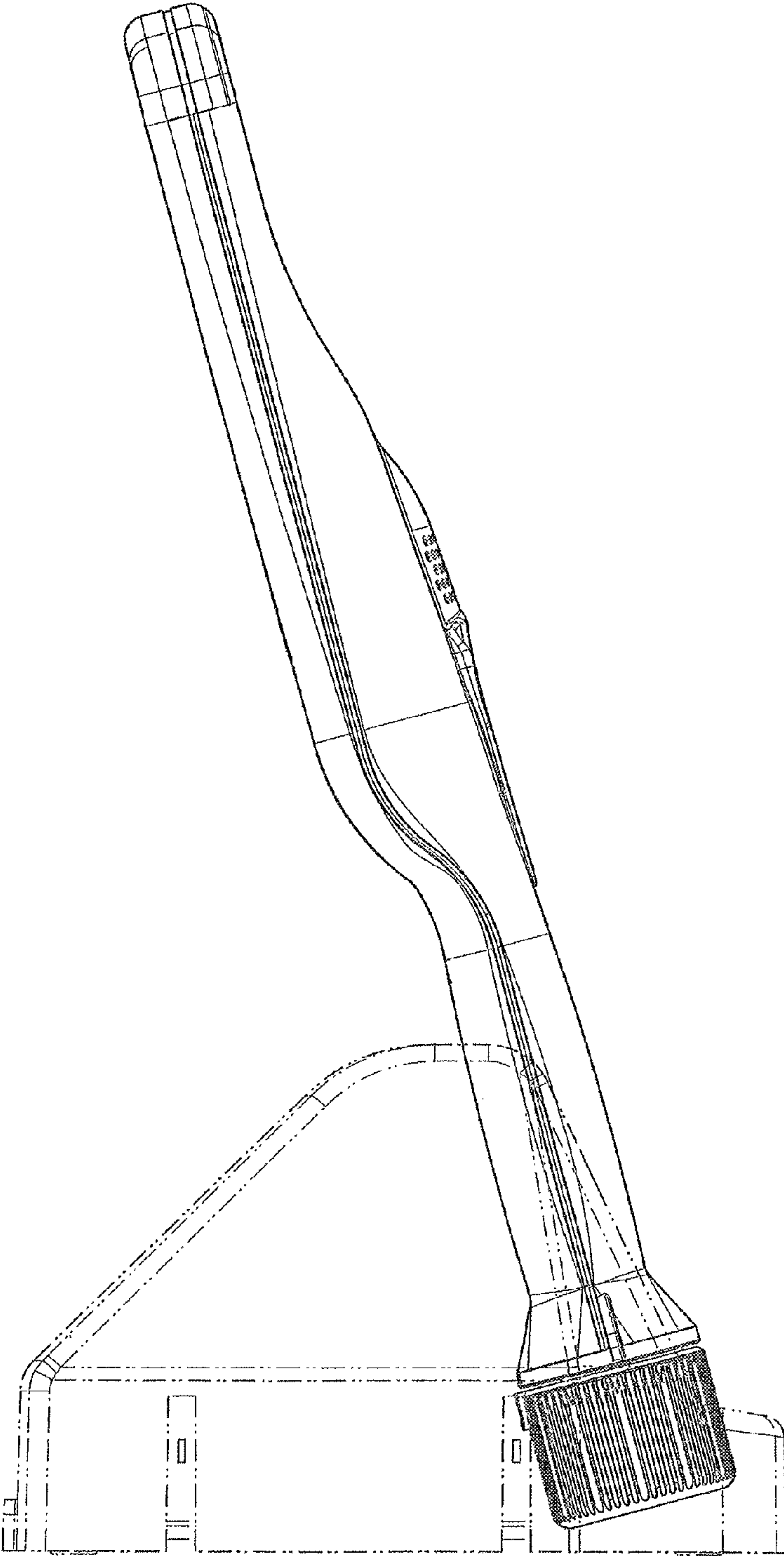

FIG. 5

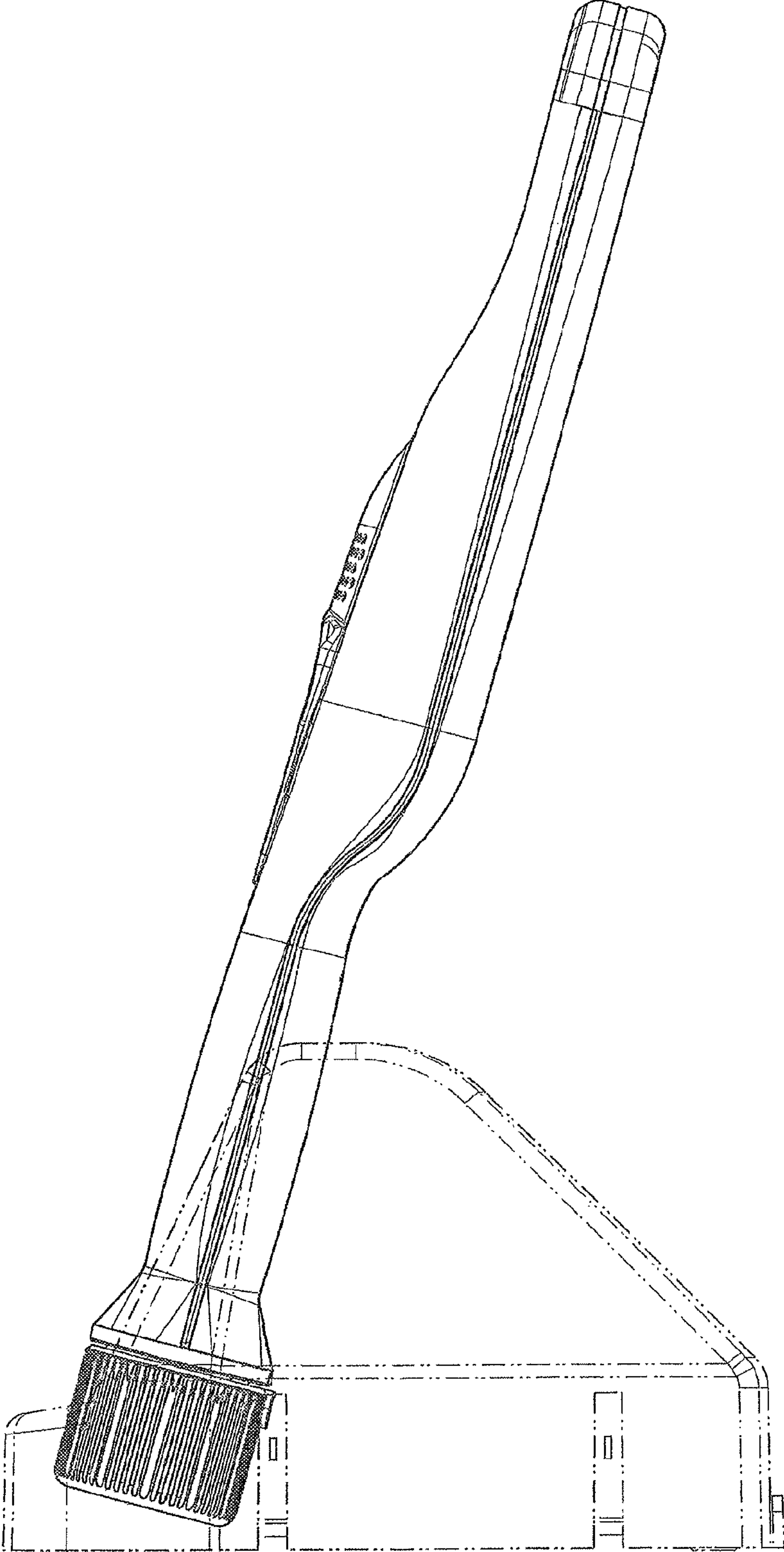

FIG. 6

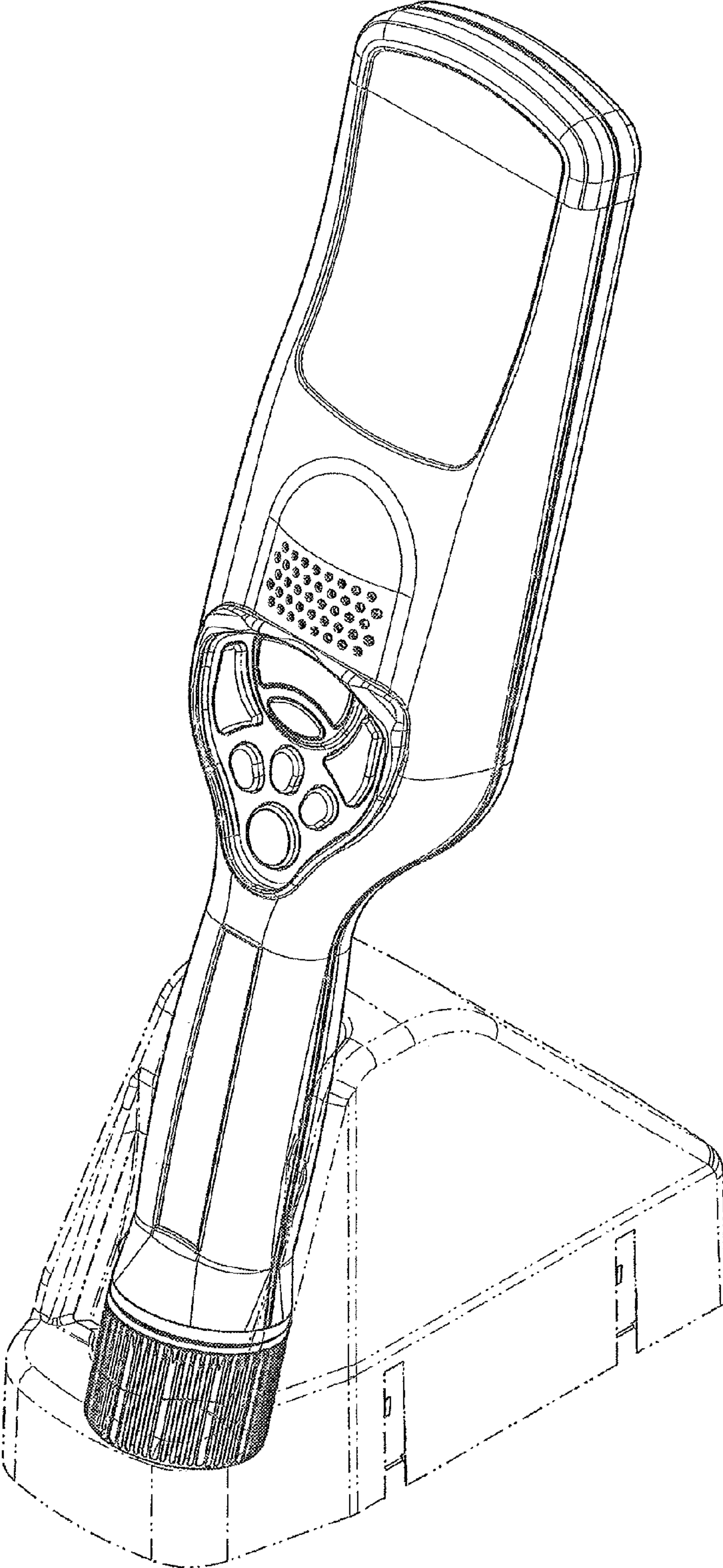

FIG. 7

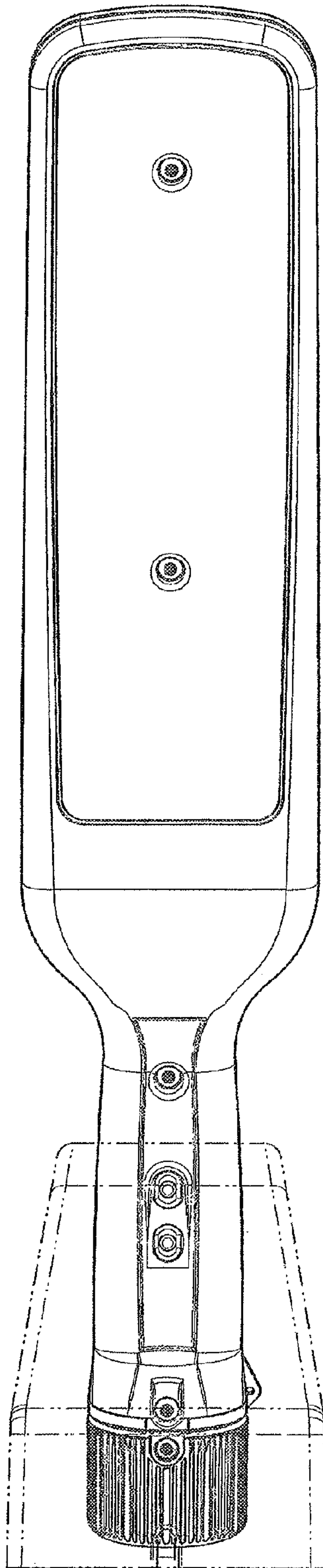

FIG. 8

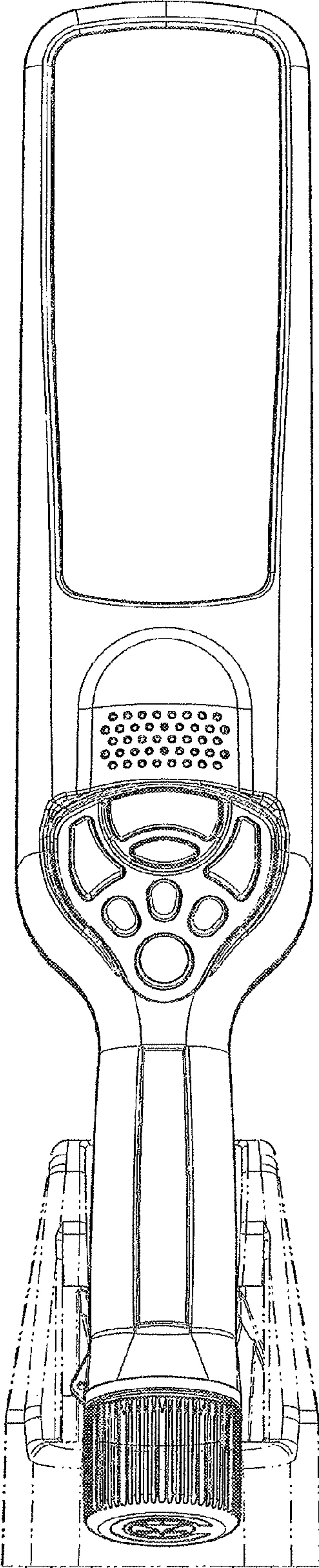

FIG. 9

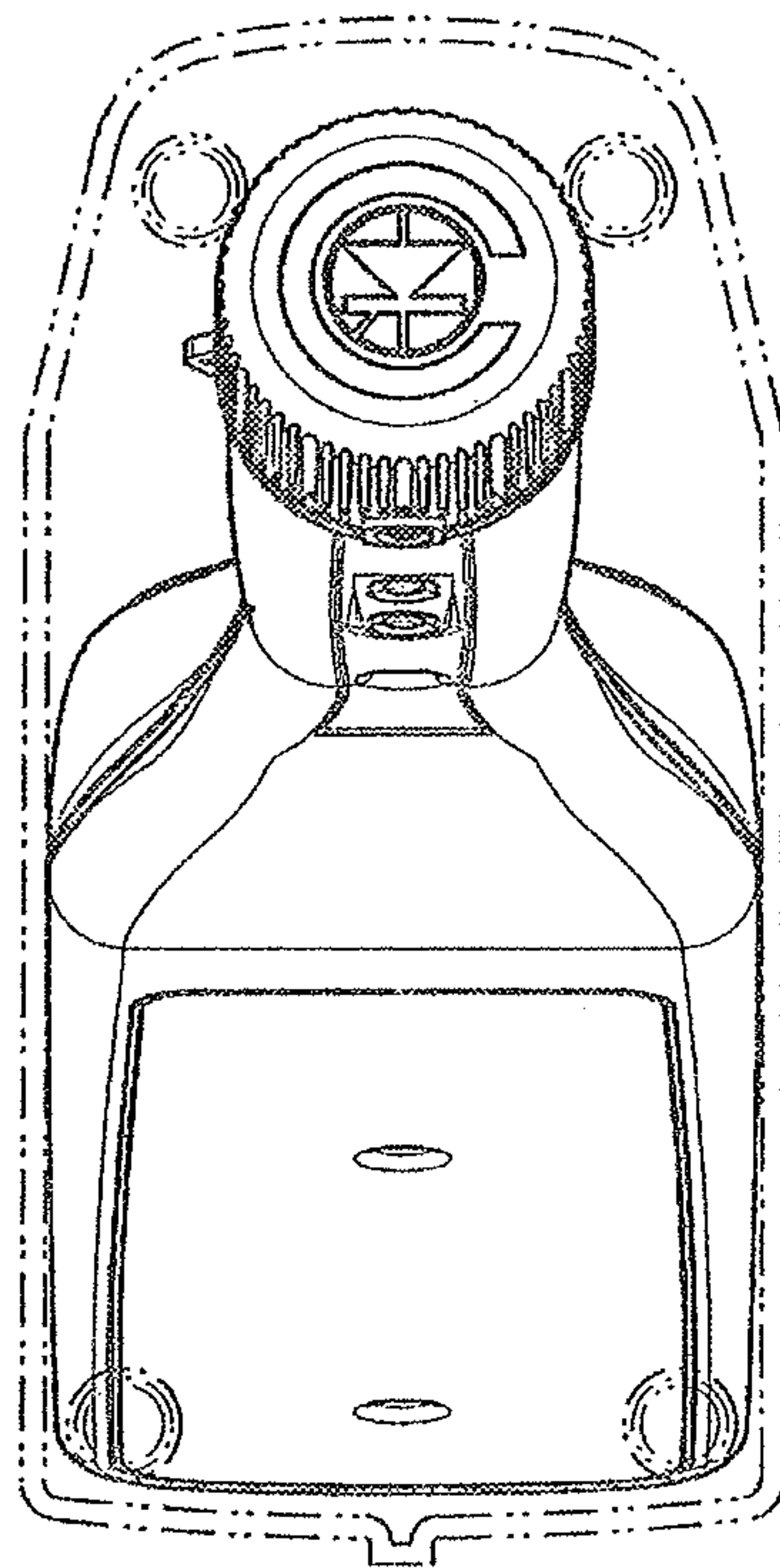

FIG. 10

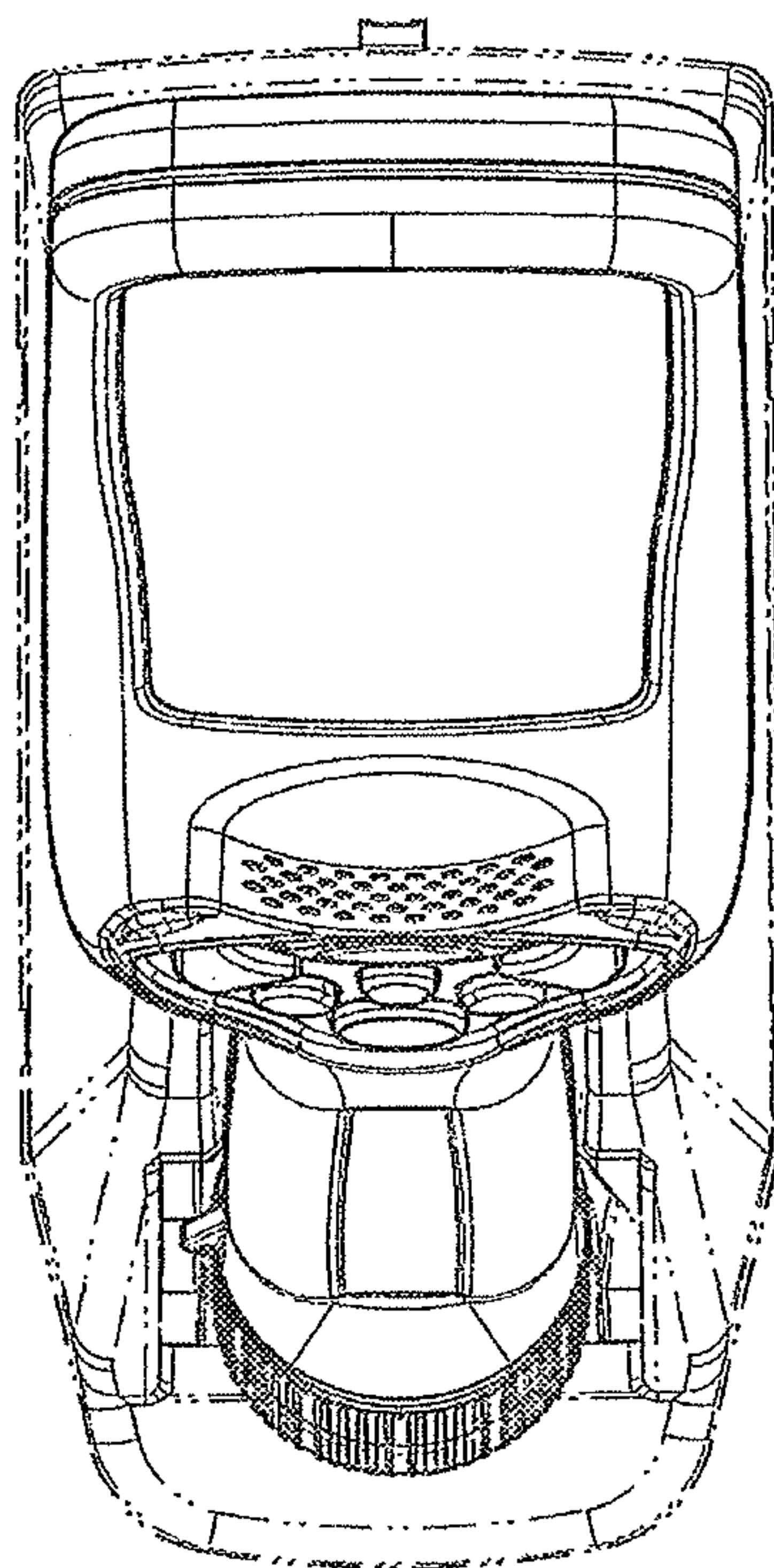

FIG. 11

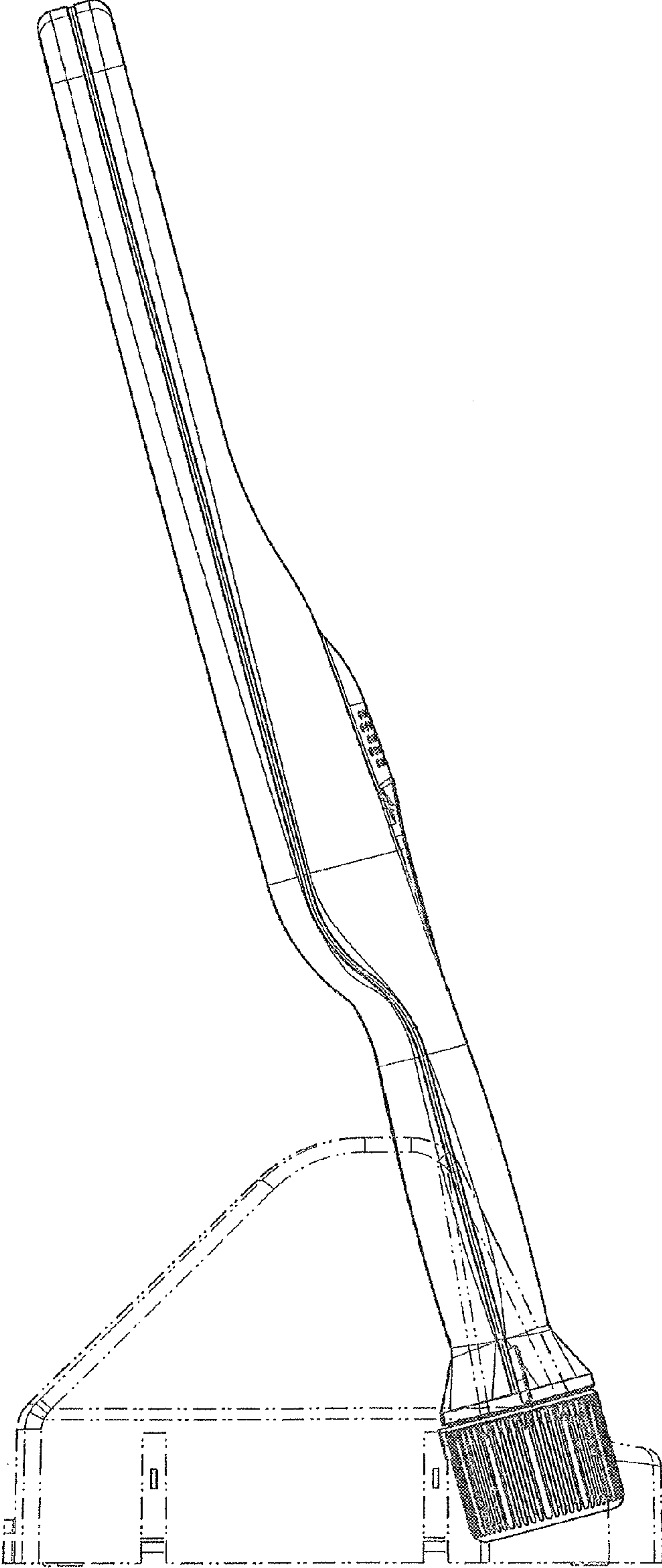

FIG. 12

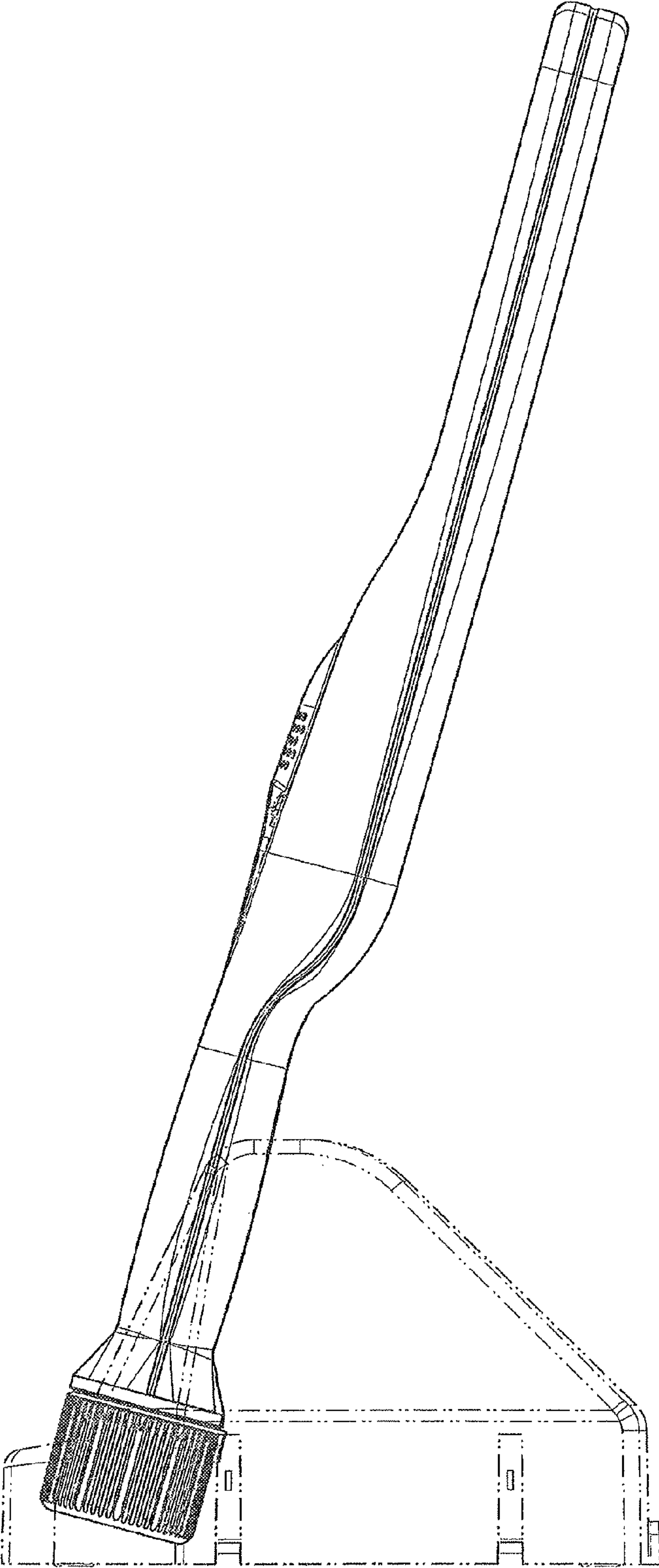

FIG. 13

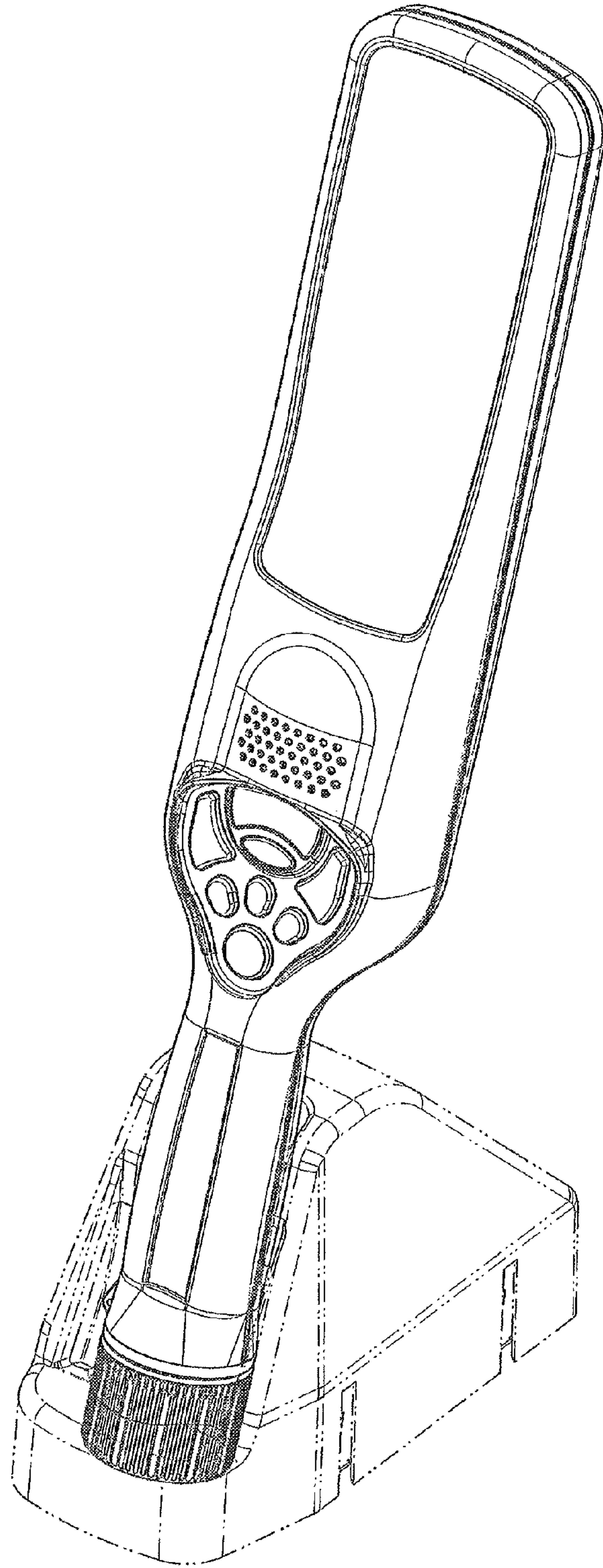

FIG. 14