

US00D694112S

(12) **United States Design Patent**  
**Brown**

(10) **Patent No.:** **US D694,112 S**

(45) **Date of Patent:** **\*\* Nov. 26, 2013**

(54) **COSMETIC CONTAINER**

(75) Inventor: **James Brown**, Congleton (GB)

(73) Assignee: **Zamya Limited**, Manchester (GB)

(\*\*) Term: **14 Years**

(21) Appl. No.: **29/430,051**

(22) Filed: **Aug. 21, 2012**

(30) **Foreign Application Priority Data**

Feb. 21, 2012 (EM) ..... 001995846-0003

(51) **LOC (9) Cl.** ..... **09-01**

(52) **U.S. Cl.**

USPC ..... **D9/503**; D9/428; D9/454

(58) **Field of Classification Search**

USPC ..... D9/428, 500, 502-503, 505, 516, 549,  
D9/558, 454; D7/602, 630, 629; D28/73,  
D28/76-77; 215/379, 382; 220/660,  
220/669-673, 675

See application file for complete search history.

(56) **References Cited**

**U.S. PATENT DOCUMENTS**

D30,087 S \* 1/1899 Kremer ..... D9/500  
2,859,786 A \* 11/1958 Tupper ..... 220/792  
3,044,610 A \* 7/1962 Tupper ..... 220/270

3,217,964 A \* 11/1965 Stegner ..... 229/5.5  
D226,063 S \* 1/1973 Warnberg ..... D9/503  
D312,400 S \* 11/1990 Schwaikert ..... D9/424  
D321,318 S \* 11/1991 Gunter ..... D9/780  
D321,477 S \* 11/1991 Gunter ..... D9/503  
D334,113 S \* 3/1993 Lewis et al. .... D7/629  
D659,337 S \* 5/2012 Bradley ..... D34/1

\* cited by examiner

*Primary Examiner* — Ian Simmons

*Assistant Examiner* — Dana L Meyrow

(74) *Attorney, Agent, or Firm* — Woodard, Emhardt,  
Moriarty, McNett & Henry LLP

(57) **CLAIM**

The ornamental design for a cosmetic container, as shown and described.

**DESCRIPTION**

FIG. 1 is a top perspective view of a cosmetic container showing my new design;

FIG. 2 is an exploded top perspective view thereof;

FIG. 3 is a side elevation view of FIG. 1;

FIG. 4 is an exploded side elevation view thereof;

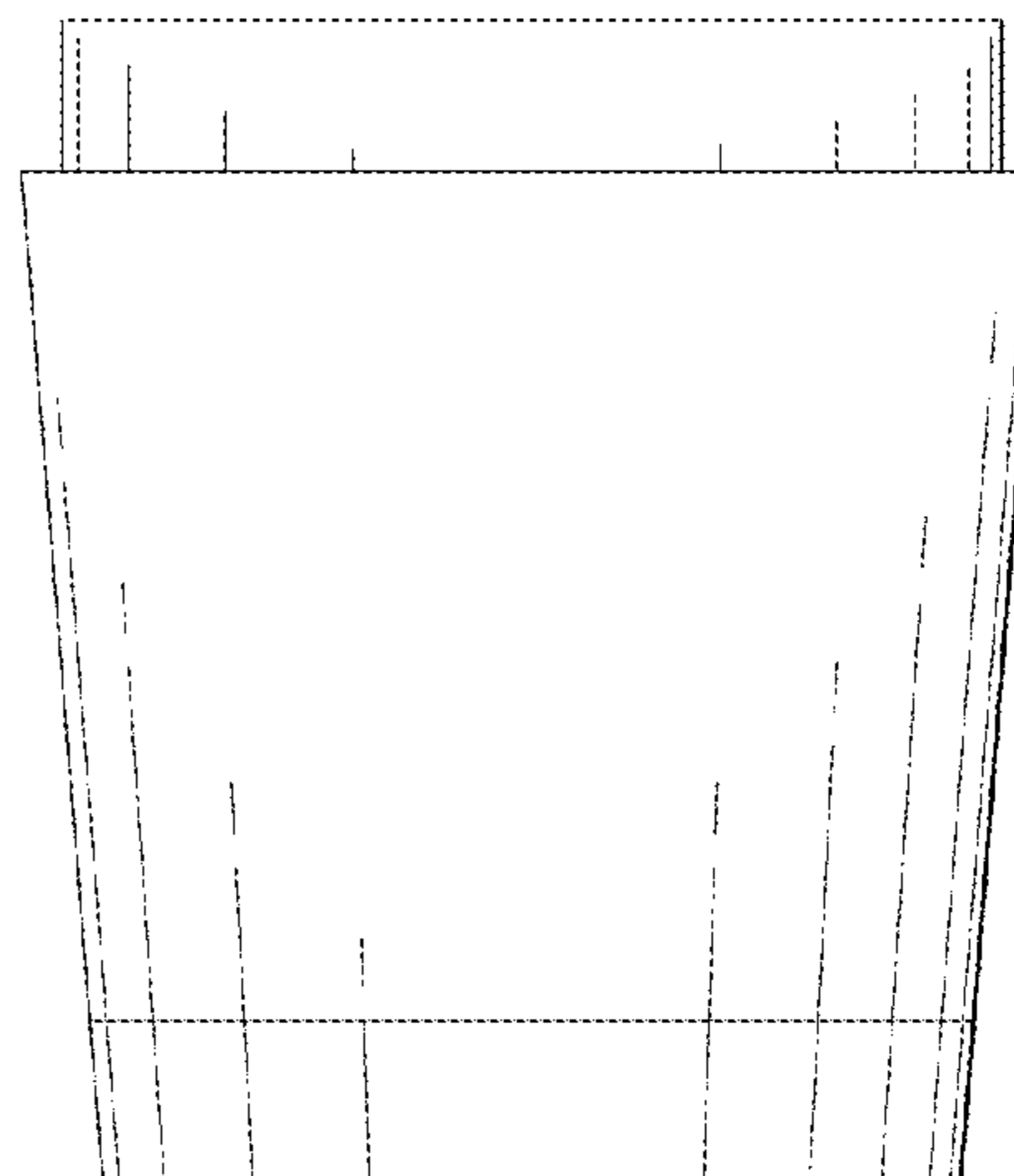
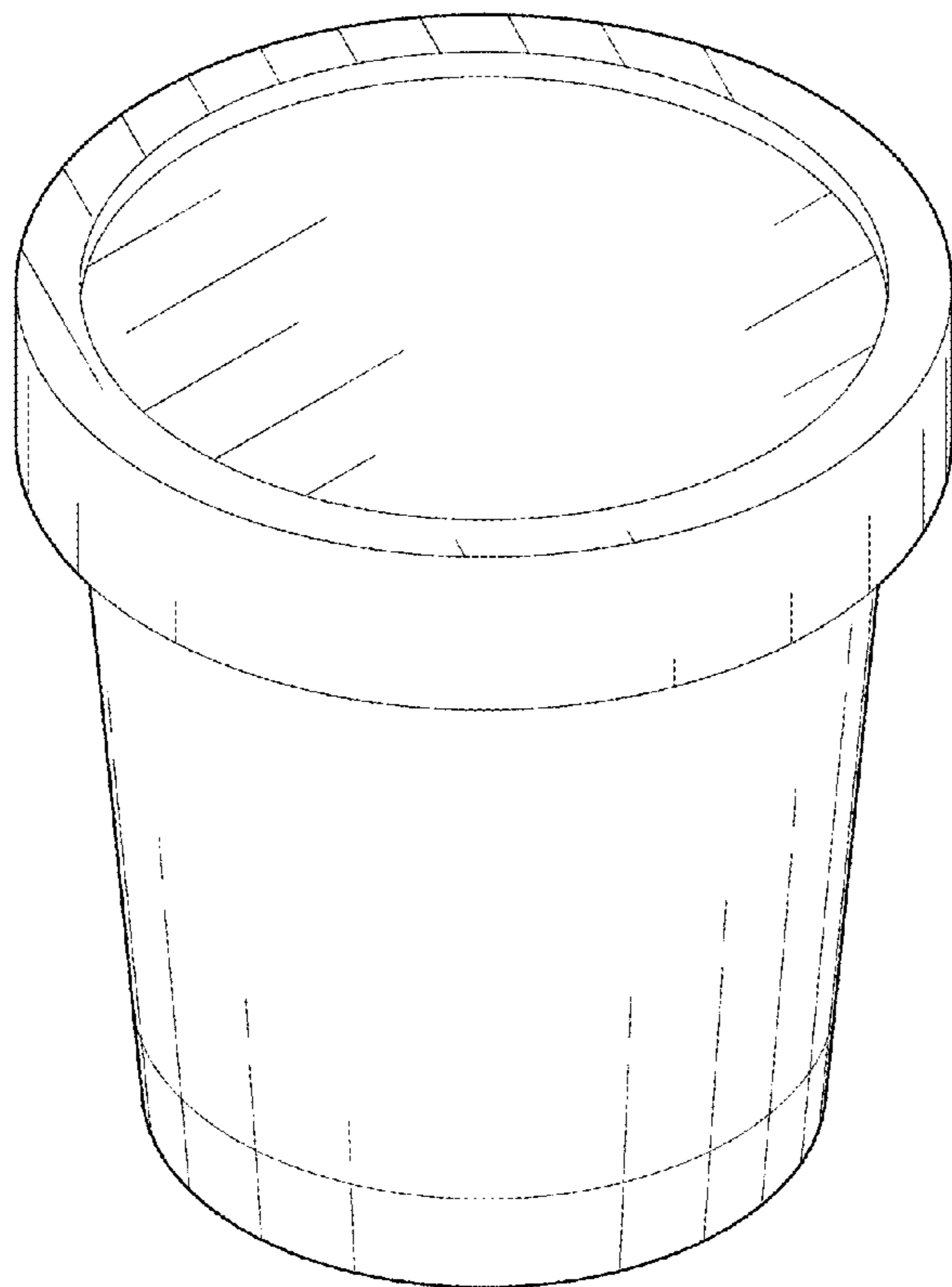
FIG. 5 is a side elevation view thereof, shown with the lid removed;

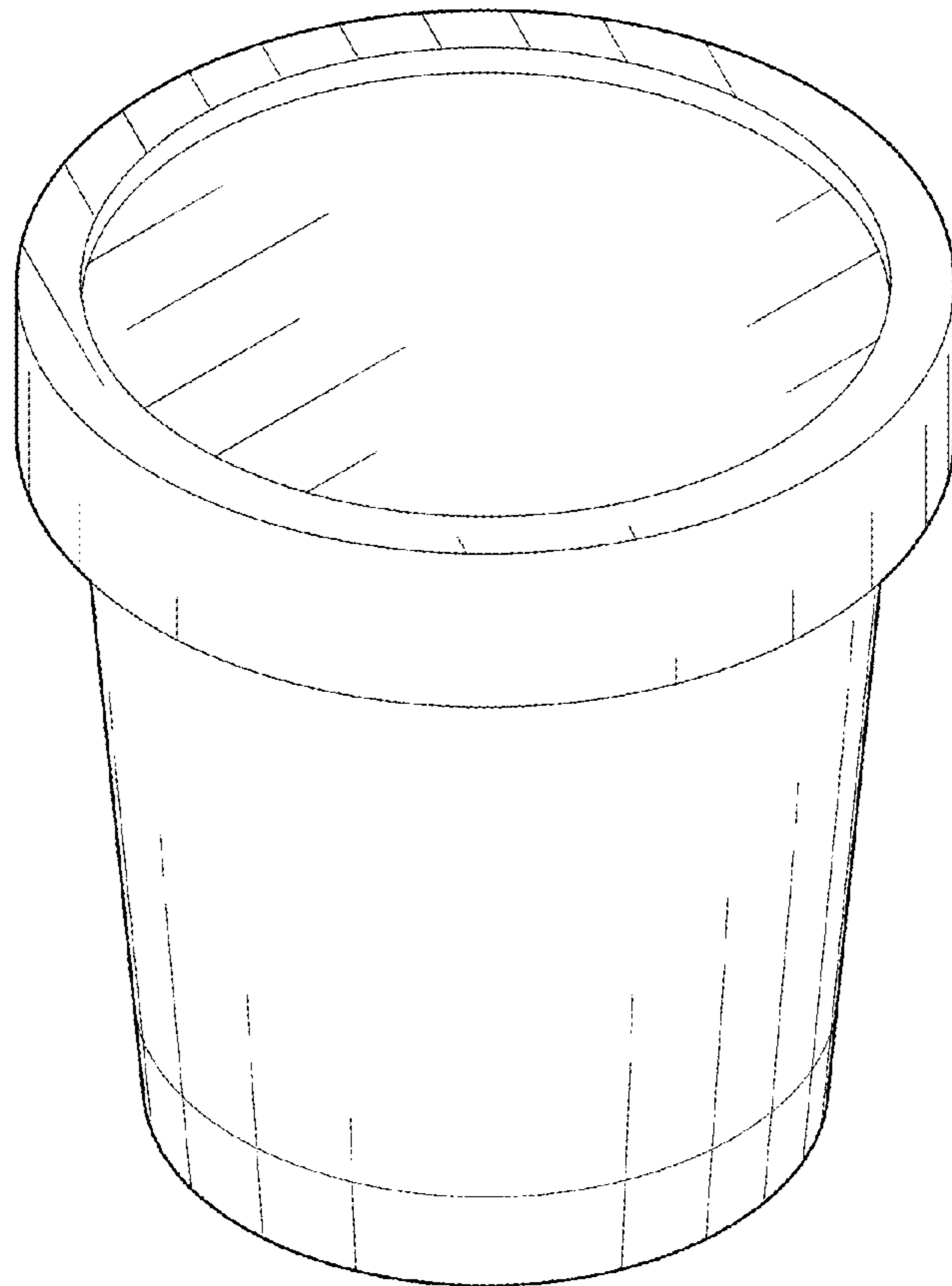
FIG. 6 is a top plan view of FIG. 1; and,

FIG. 7 is a top plan view of the cosmetic container with the lid removed.

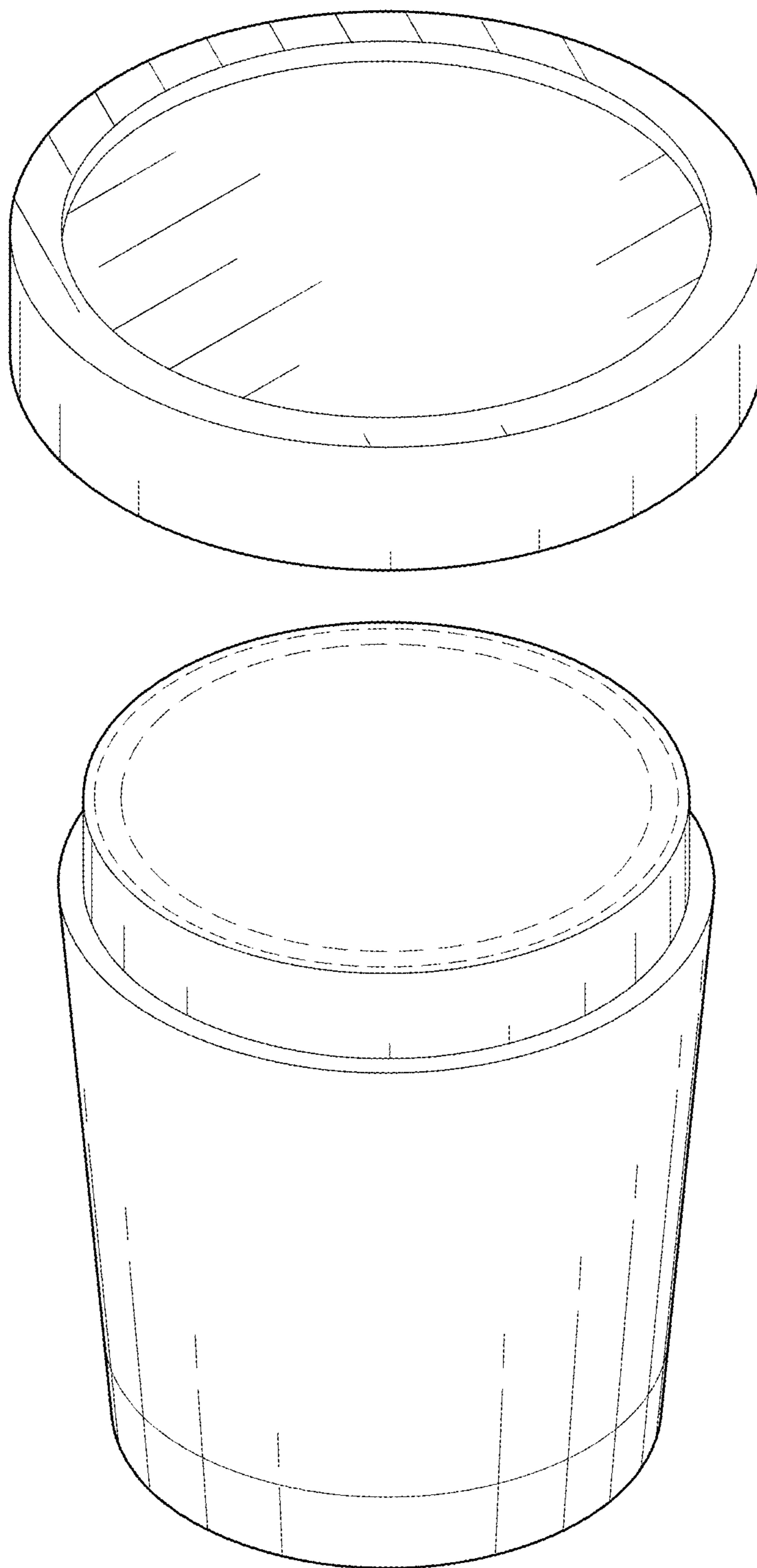
The dashed broken lines in the drawings show unclaimed environmental details on the inside of the cosmetic container that form no part of the claim.

**1 Claim, 6 Drawing Sheets**

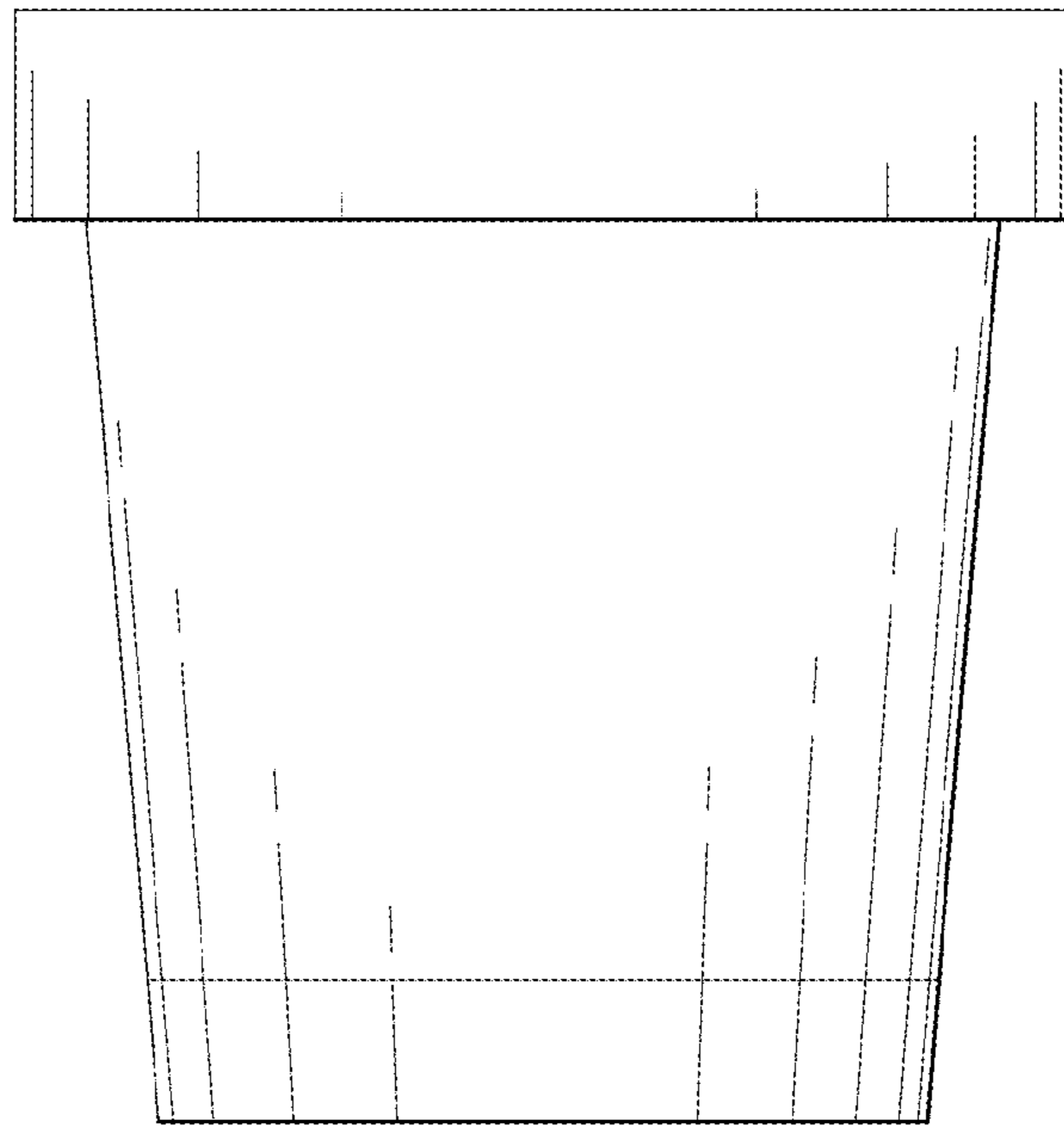




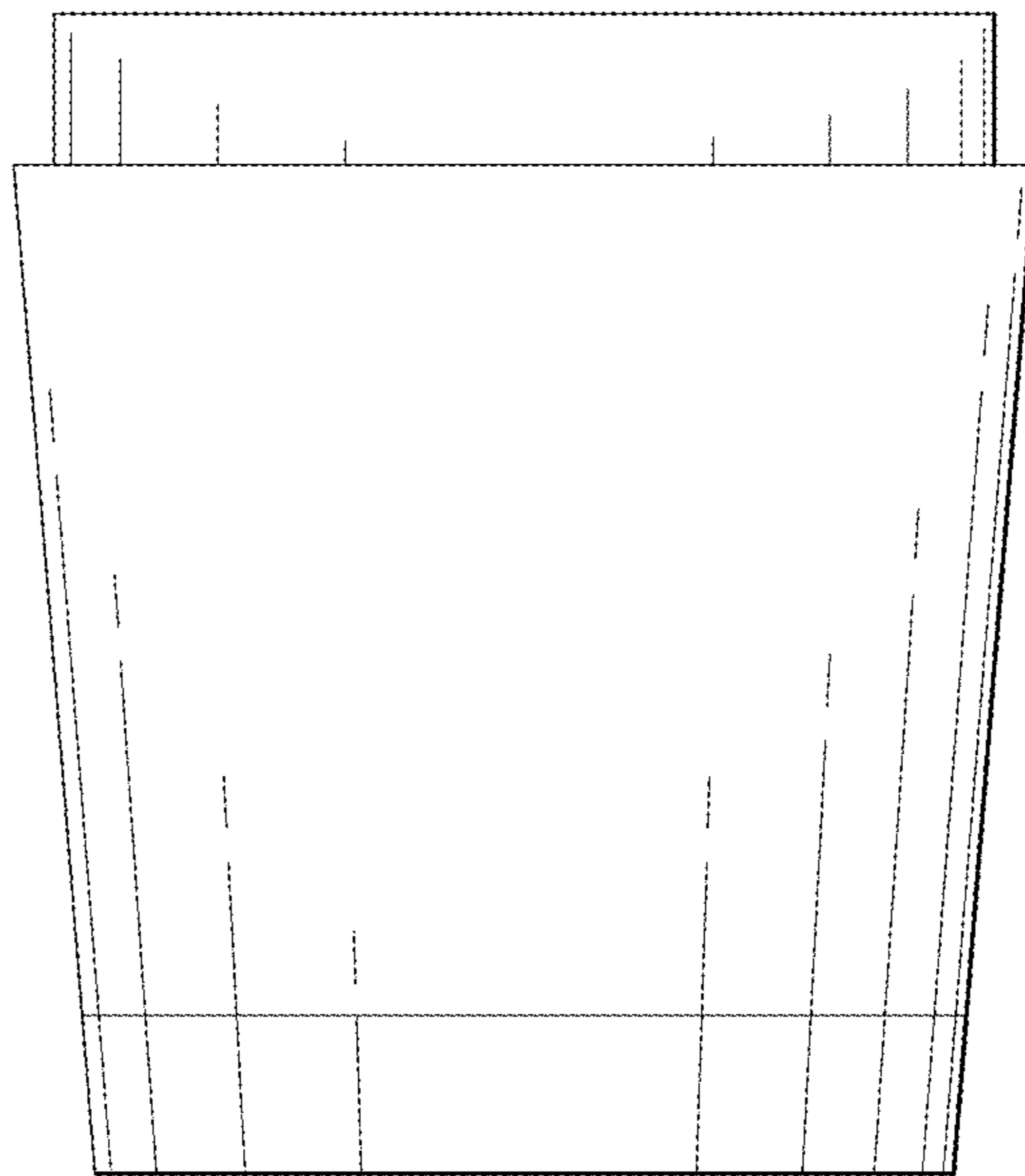
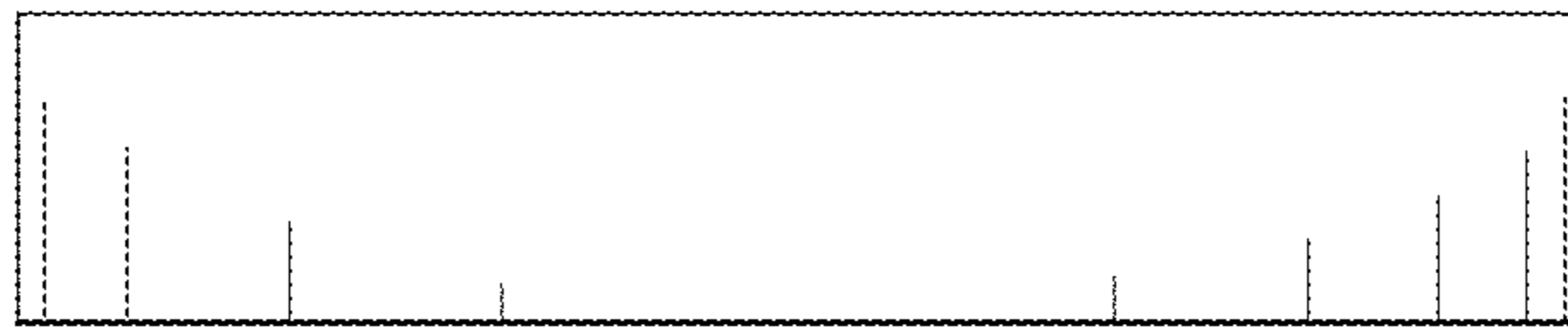
***Fig. 1***



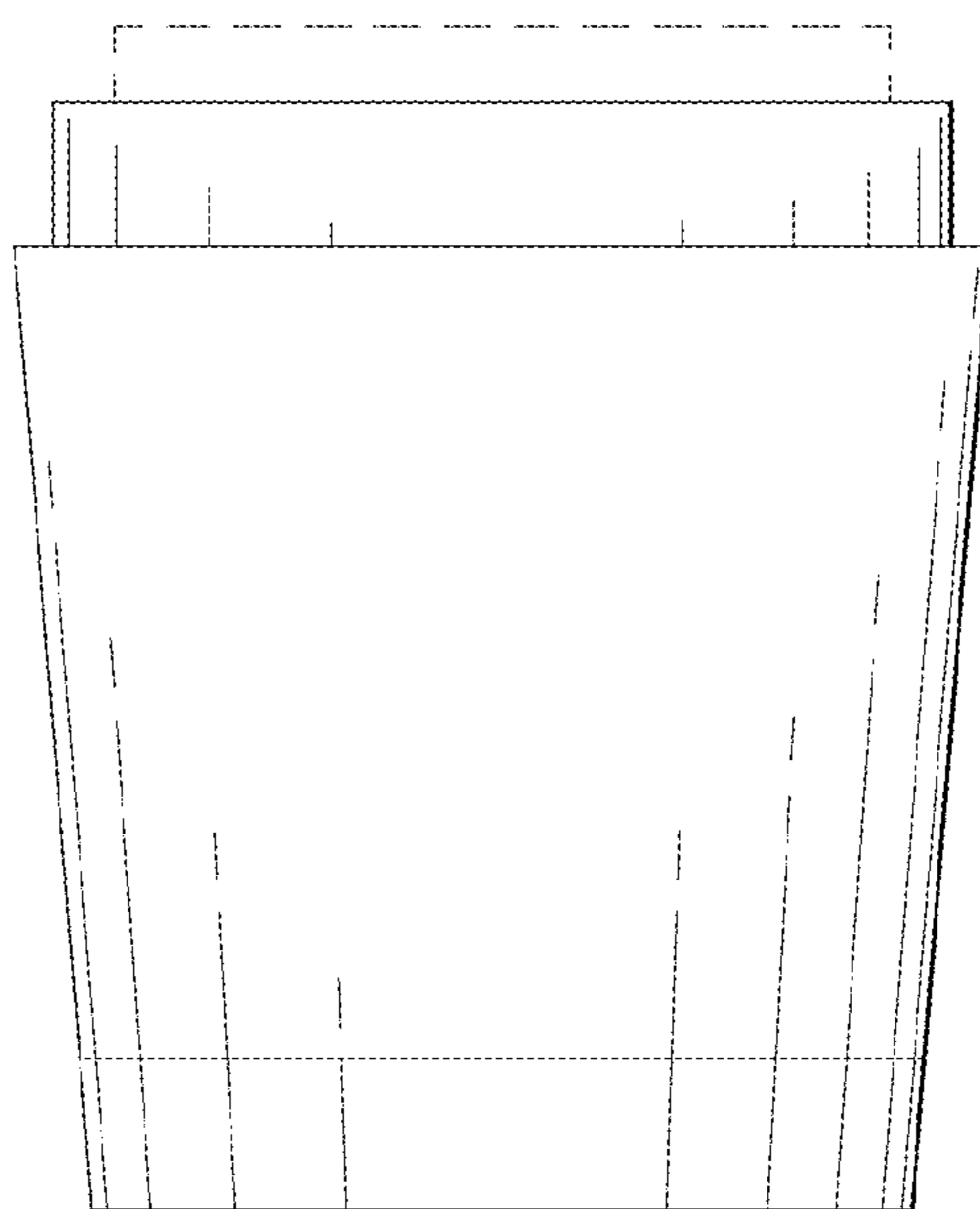
**Fig. 2**



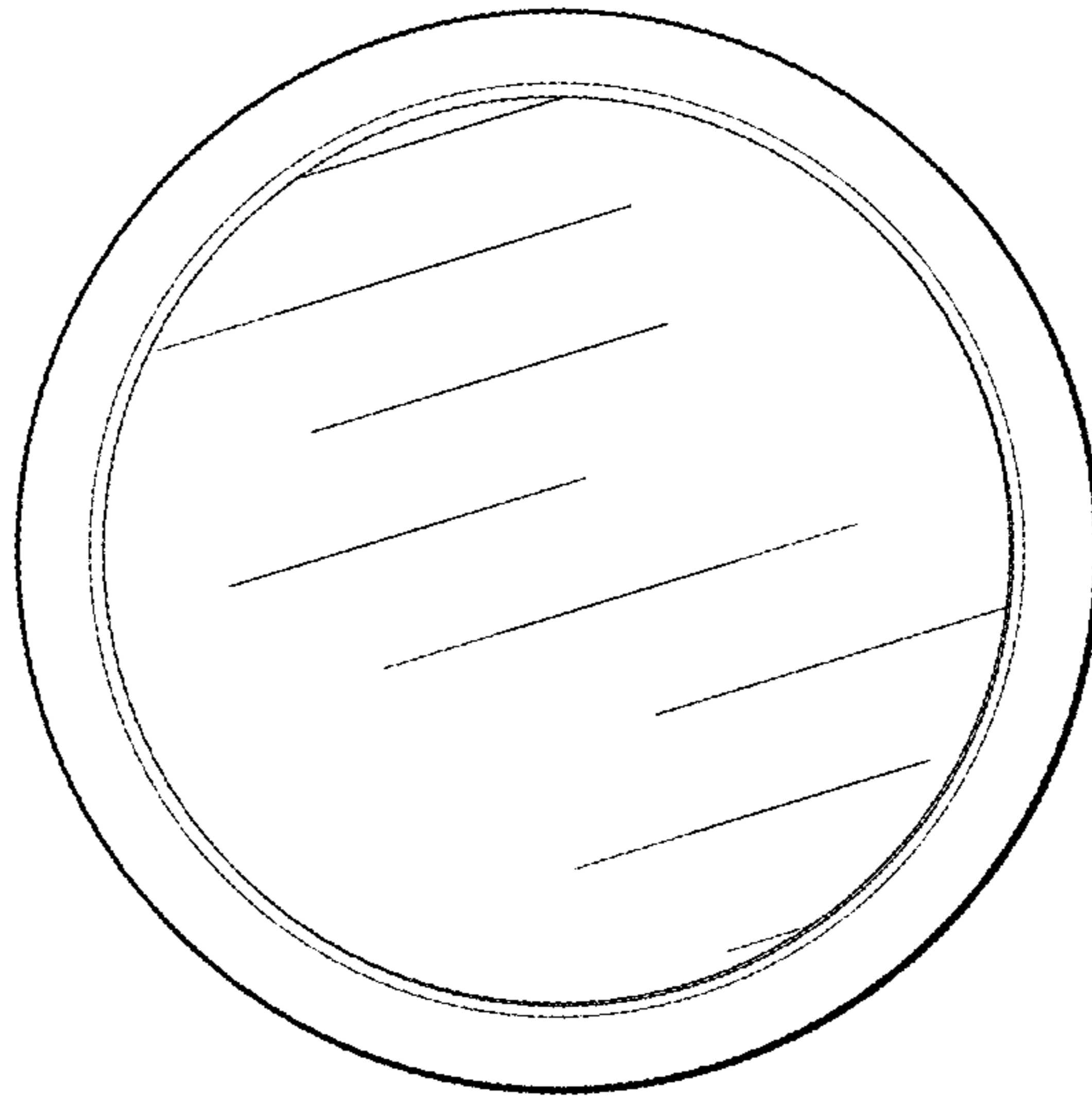
**Fig. 3**



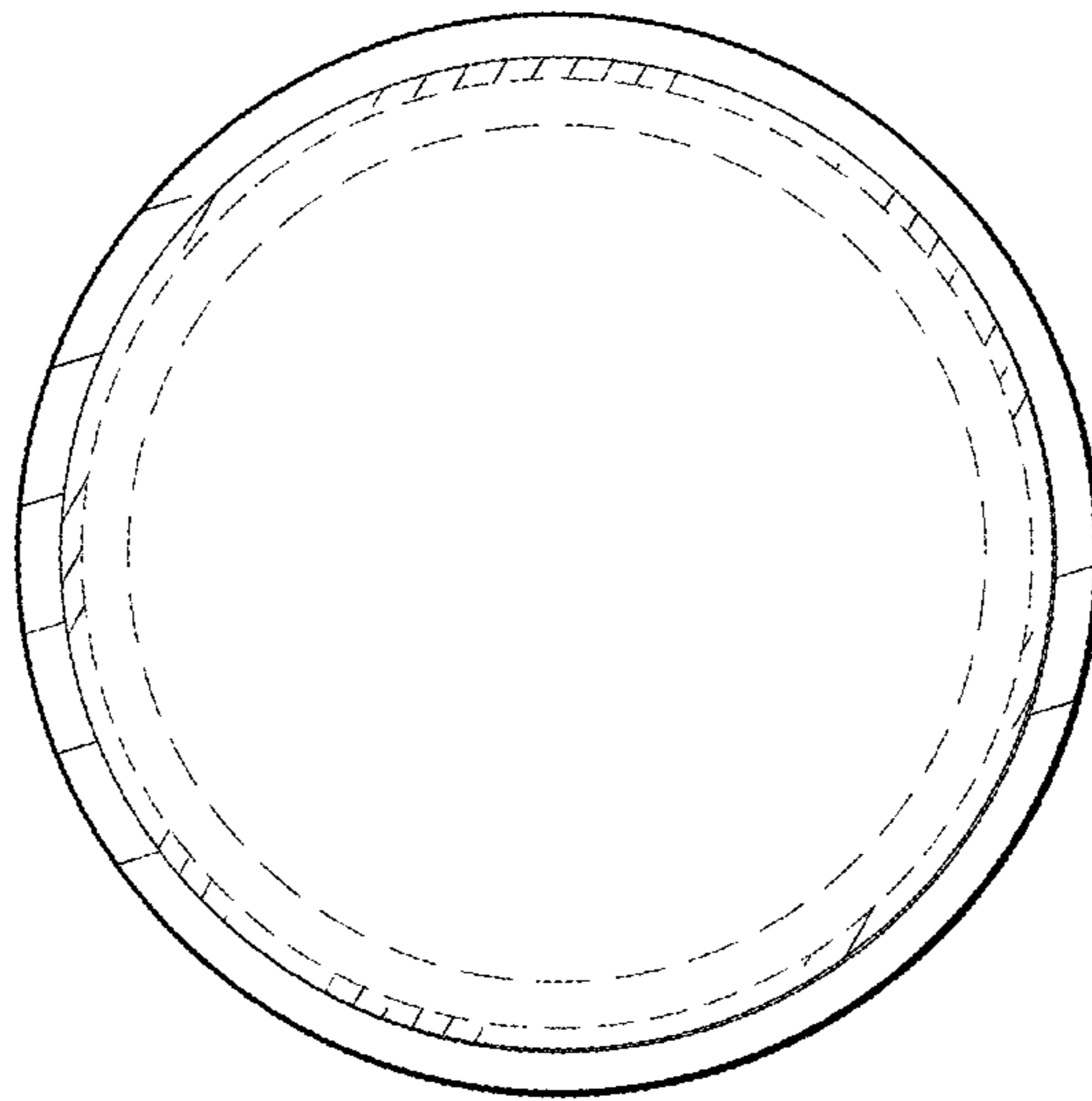
**Fig. 4**



**Fig. 5**



**Fig. 6**



**Fig. 7**