



US00D694104S

(12) **United States Design Patent**  
**Barrett et al.**

(10) **Patent No.:** **US D694,104 S**  
(45) **Date of Patent:** **\*\* Nov. 26, 2013**

(54) **CONTAINER**

(75) Inventors: **Robert Barrett**, Toronto (CA); **Mauro Coletti**, Maple (CA); **Matthew Brett**, Toronto (CA)

(73) Assignee: **Polytainers Inc.**, Toronto (CA)

(\*\*) Term: **14 Years**

(21) Appl. No.: **29/418,762**

(22) Filed: **Apr. 20, 2012**

(51) **LOC (9) Cl.** ..... **09-03**

(52) **U.S. Cl.**  
USPC ..... **D9/429**

(58) **Field of Classification Search**

USPC ..... D9/424, 425, 428, 429, 431; D7/412,  
D7/396.2-396.4, 530, 531, 608;  
229/400-406, 932; 220/359.2, 574,  
220/656-659, 669-675, 912; 206/499, 508,  
206/557

See application file for complete search history.

(56) **References Cited**

**U.S. PATENT DOCUMENTS**

2,121,165	A *	6/1938	Slobodkin	.....	220/574
D196,332	S *	9/1963	Lynch	.....	D9/429
D220,031	S *	3/1971	Donovan	.....	D9/429
D437,730	S *	2/2001	Littmann	.....	D7/412
D442,860	S *	5/2001	Symons et al.	.....	D9/428
D445,297	S *	7/2001	Atkins et al.	.....	D7/396.4
6,648,163	B2 *	11/2003	Porter et al.	.....	220/359.2
D510,679	S *	10/2005	Smith et al.	.....	D7/396.2
D628,883	S *	12/2010	Stephens	.....	D9/429
D673,849	S *	1/2013	Barbier	.....	D9/429
D684,857	S *	6/2013	Zhen	.....	D9/429

\* cited by examiner

*Primary Examiner* — Thomas Johannes

(74) *Attorney, Agent, or Firm* — McMillan LLP

(57) **CLAIM**

The ornamental design for a container, as shown and described.

**DESCRIPTION**

FIG. 1 is a top perspective view of a first embodiment of a container showing our new design; FIG. 2 is a front elevation view thereof; FIG. 3 is a back elevation view thereof; FIG. 4 is a right elevation view thereof; FIG. 5 is a left elevation view thereof; FIG. 6 is a top plan view thereof; FIG. 7 is a bottom plan view thereof; FIG. 8 is a top perspective view of a second embodiment of a container showing our new design; FIG. 9 is a front elevation view thereof; FIG. 10 is a back elevation view thereof; FIG. 11 is a right elevation view thereof; FIG. 12 is a left elevation view thereof; FIG. 13 is a top plan view thereof; FIG. 14 is a bottom plan view thereof; FIG. 15 is a top perspective view of a third embodiment of a container showing our new design; FIG. 16 is a front elevation view thereof; FIG. 17 is a back elevation view thereof; FIG. 18 is a right elevation view thereof; FIG. 19 is a left elevation view thereof; FIG. 20 is a top plan view thereof; and, FIG. 21 is a bottom plan view thereof. The features shown in broken lines depict unclaimed environmental subject matter only and form no part of the claimed design.

**1 Claim, 21 Drawing Sheets**

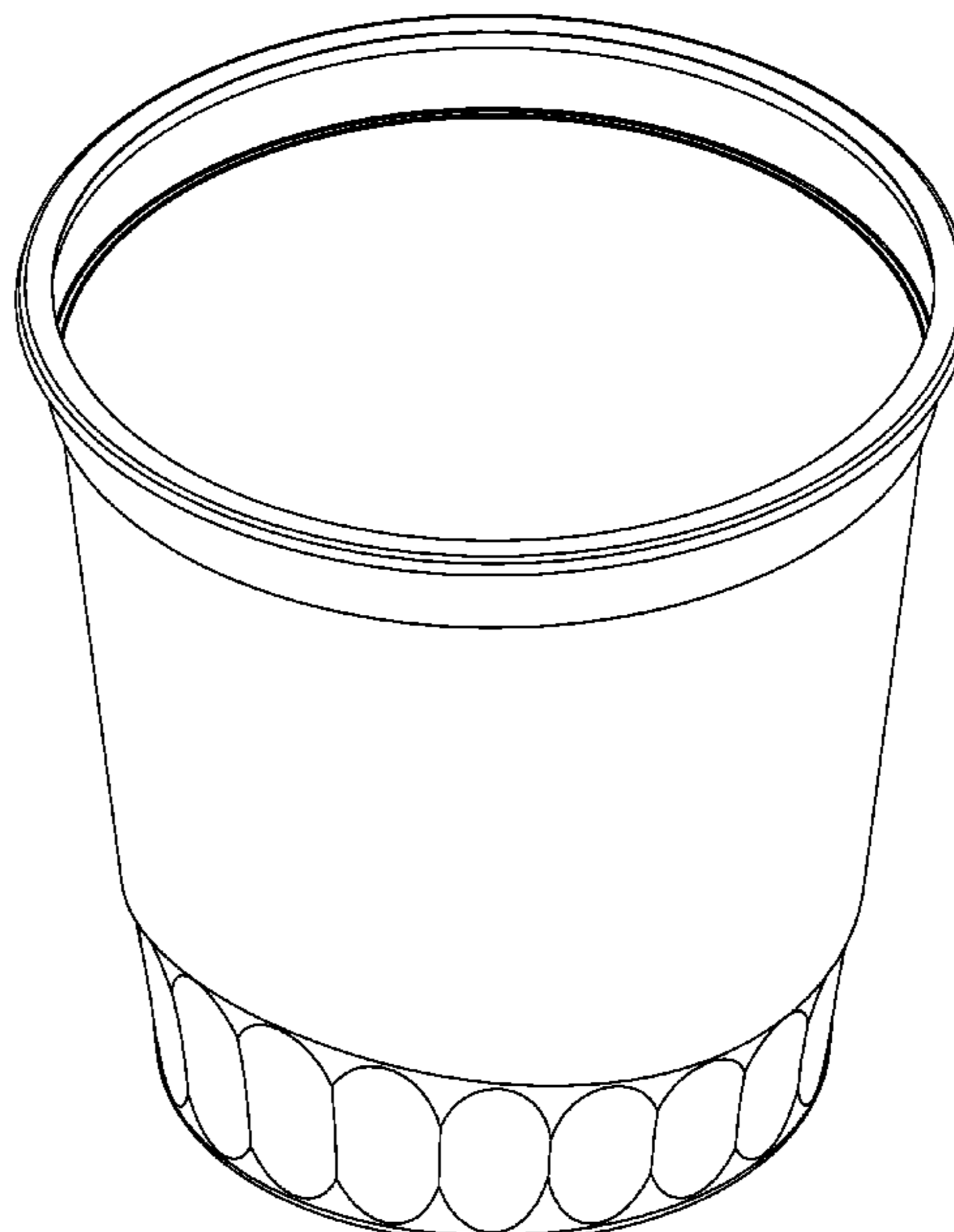
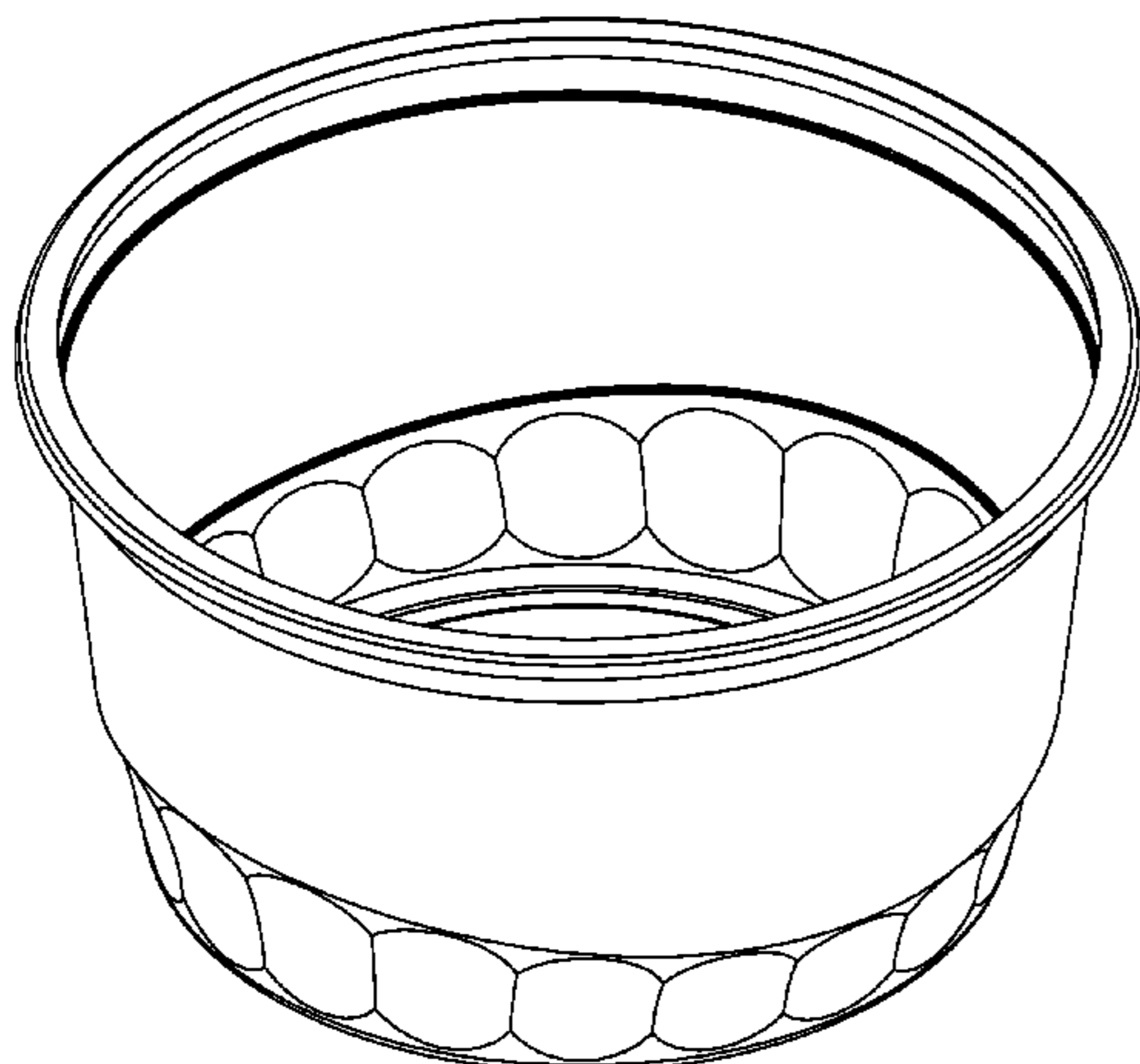

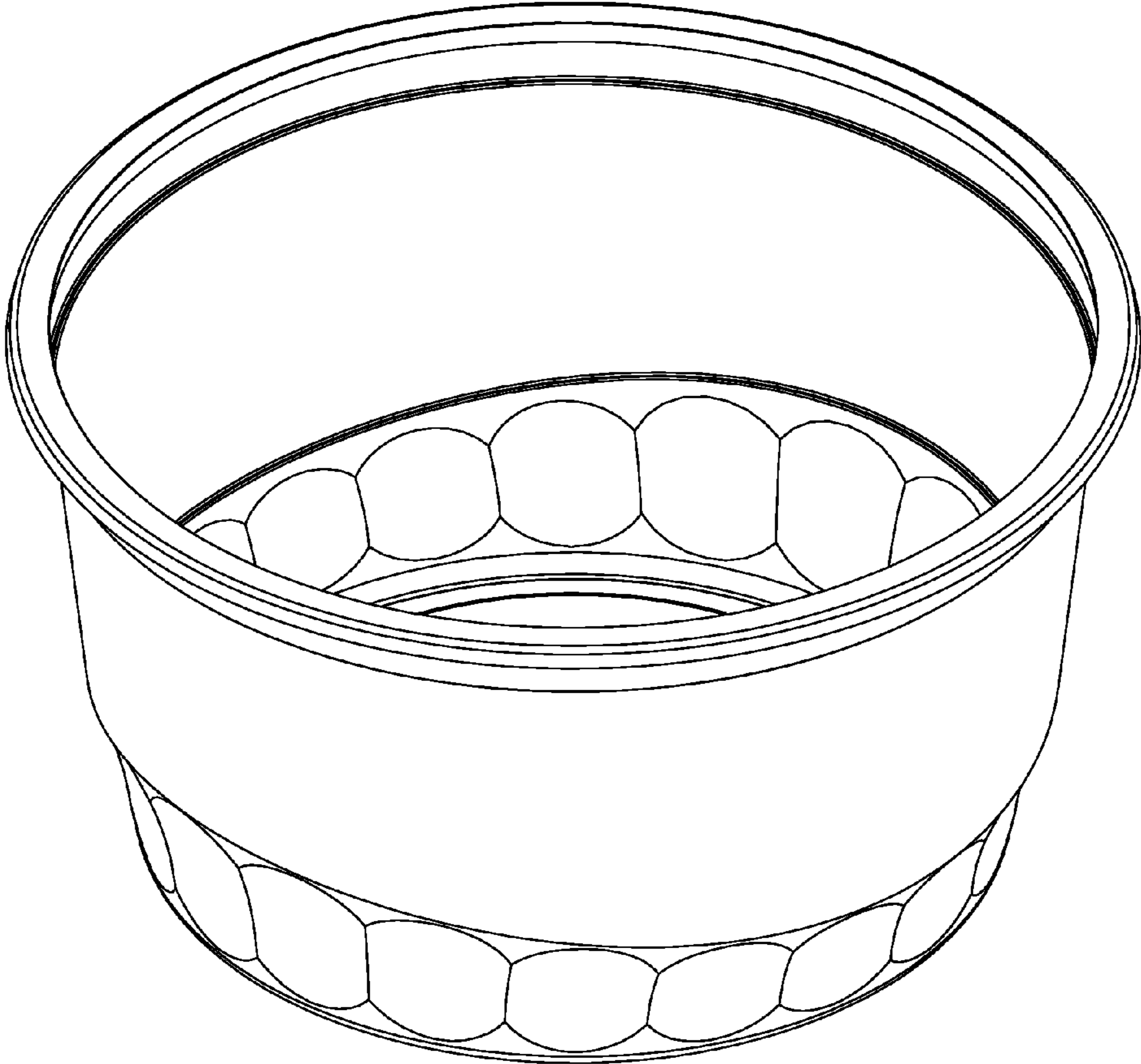

FIG. 1

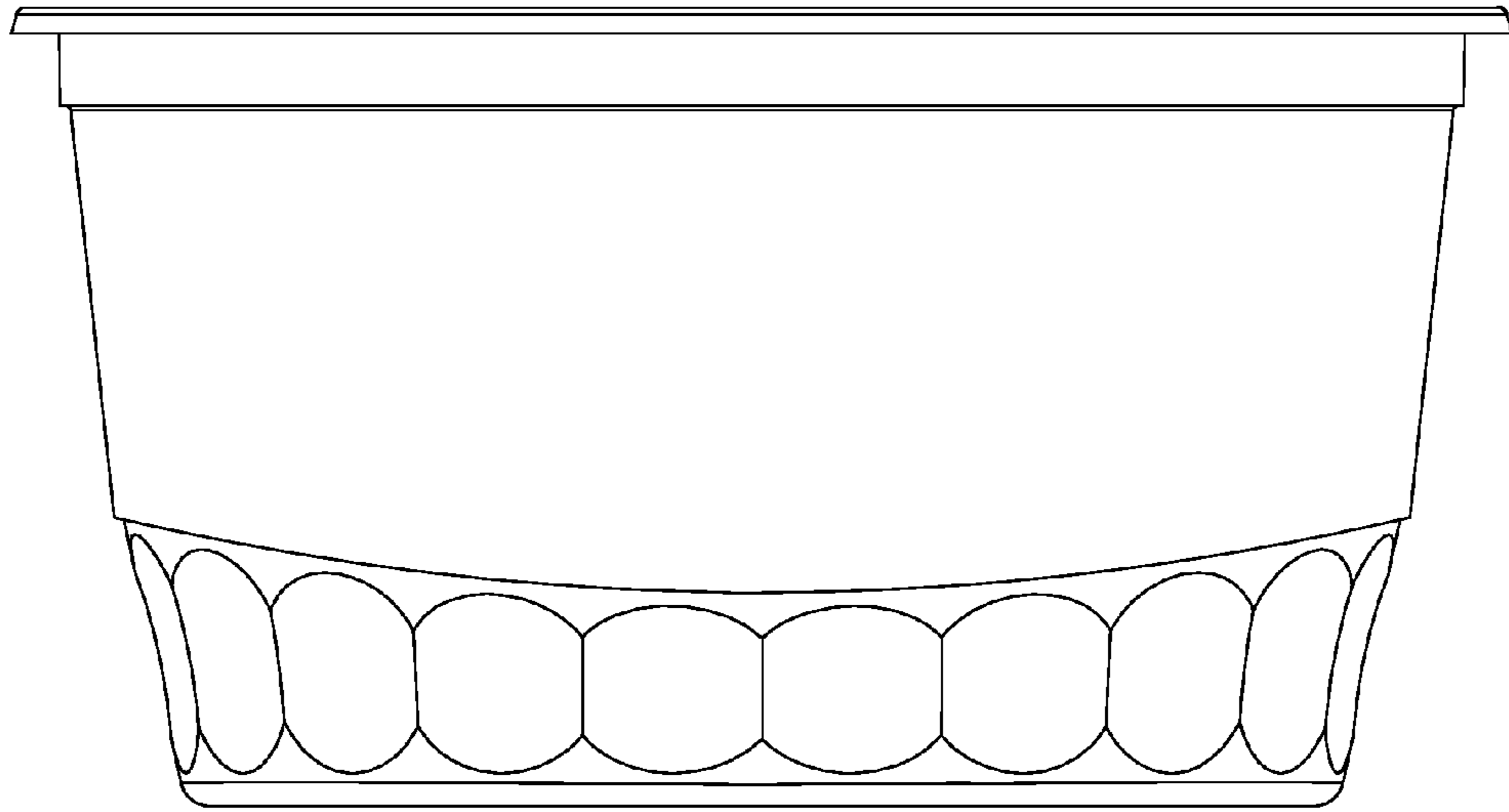

FIG. 2

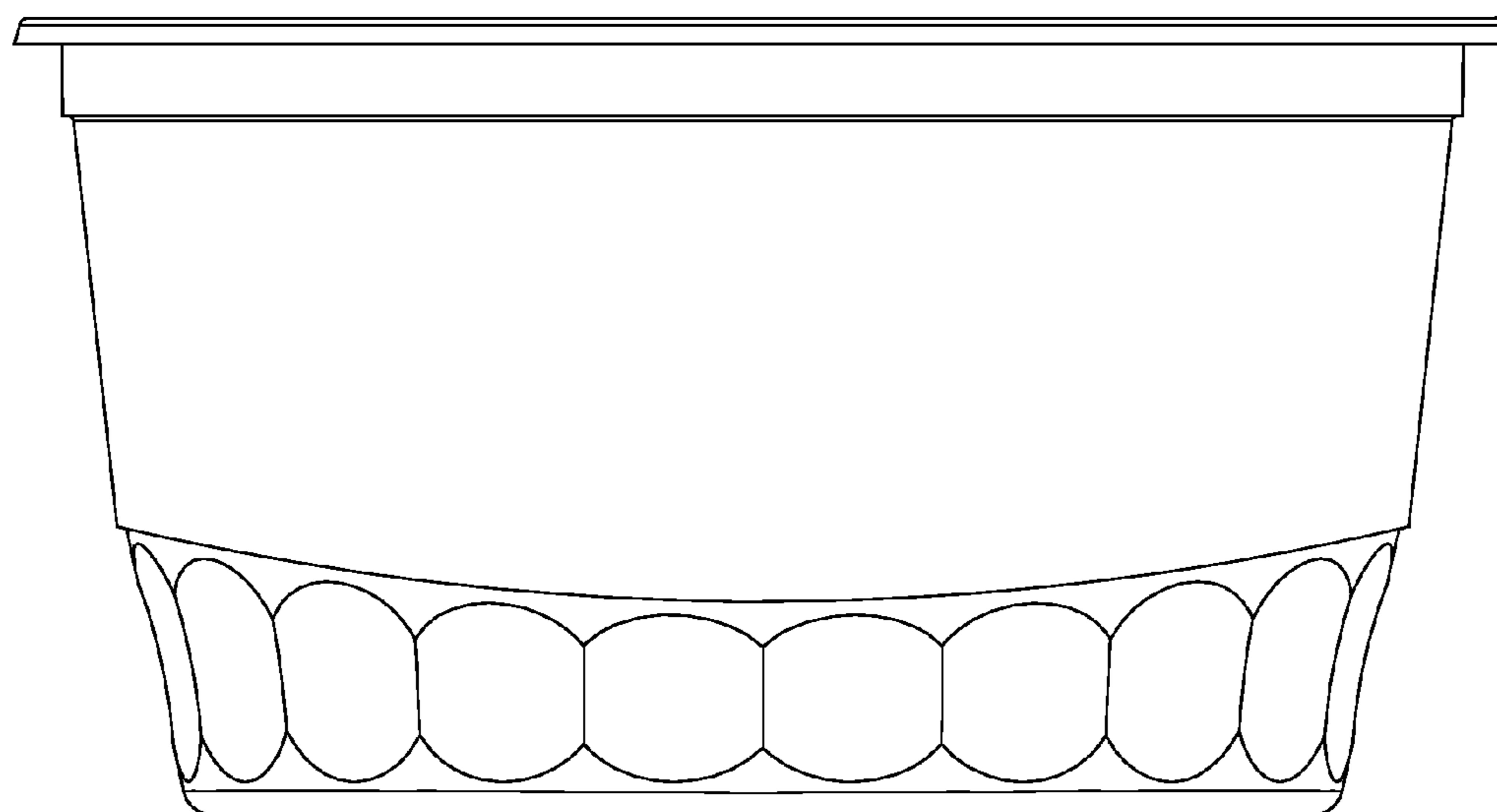

FIG. 3

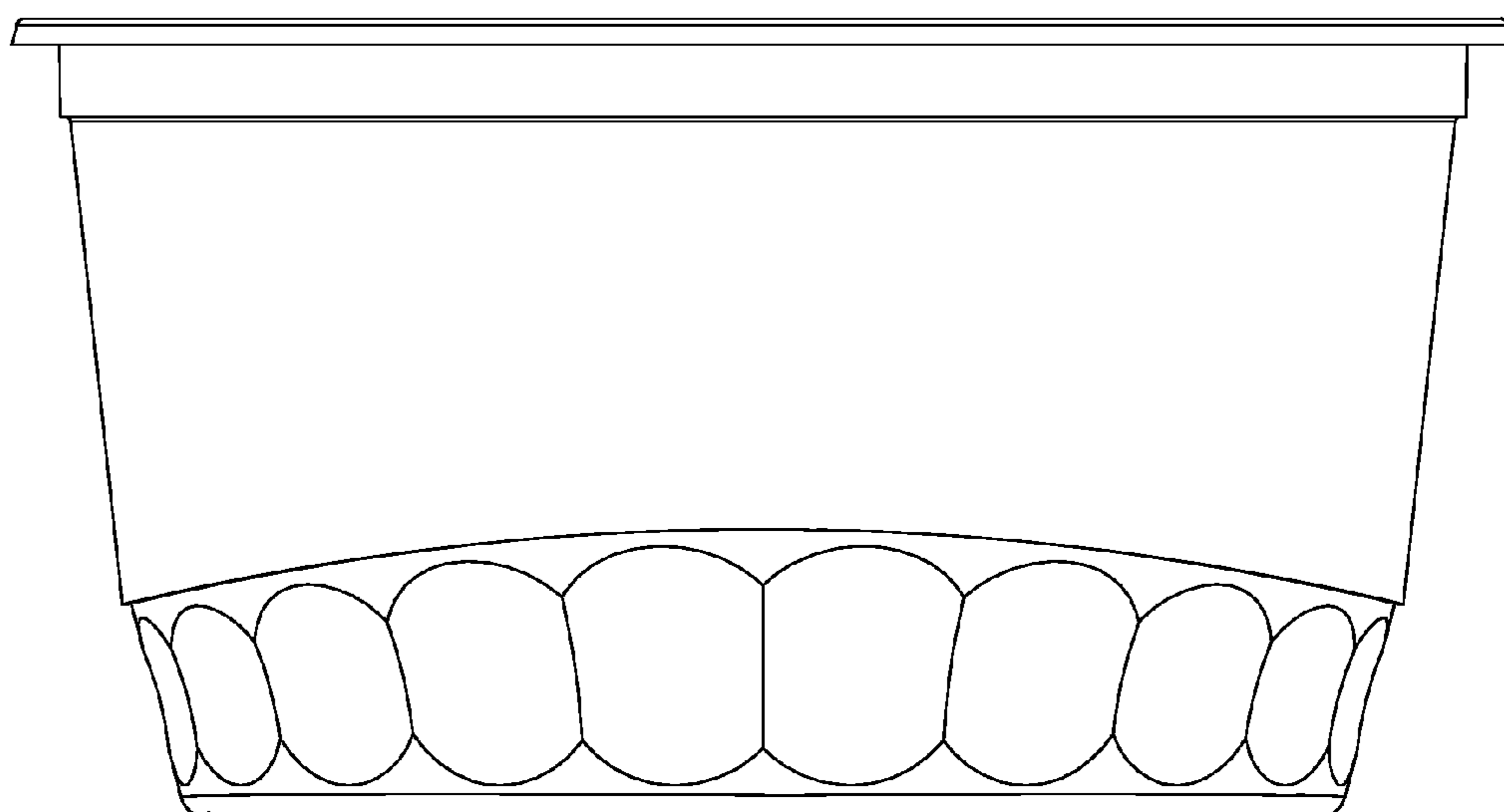

FIG. 4

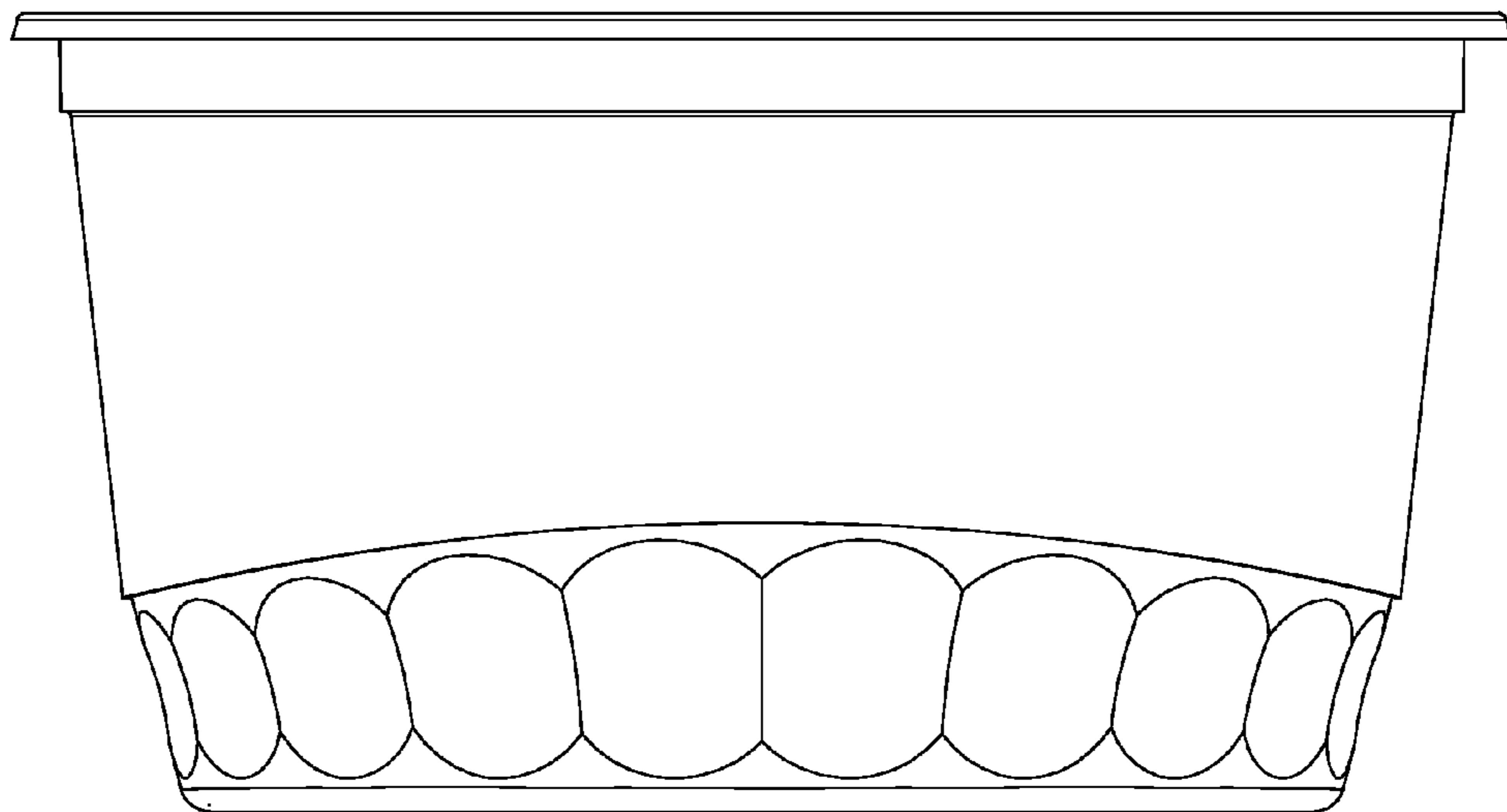

FIG. 5

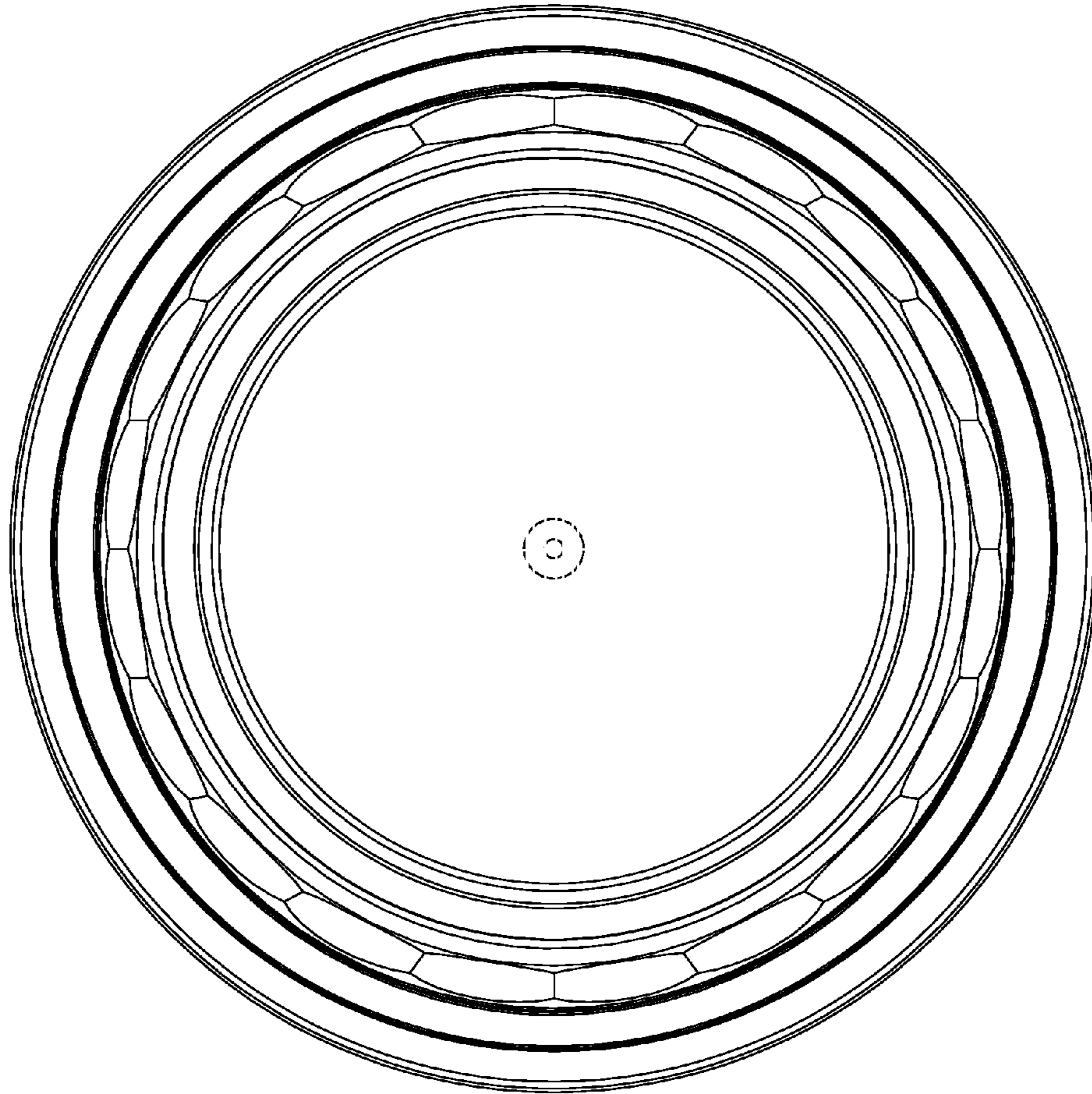

FIG. 6

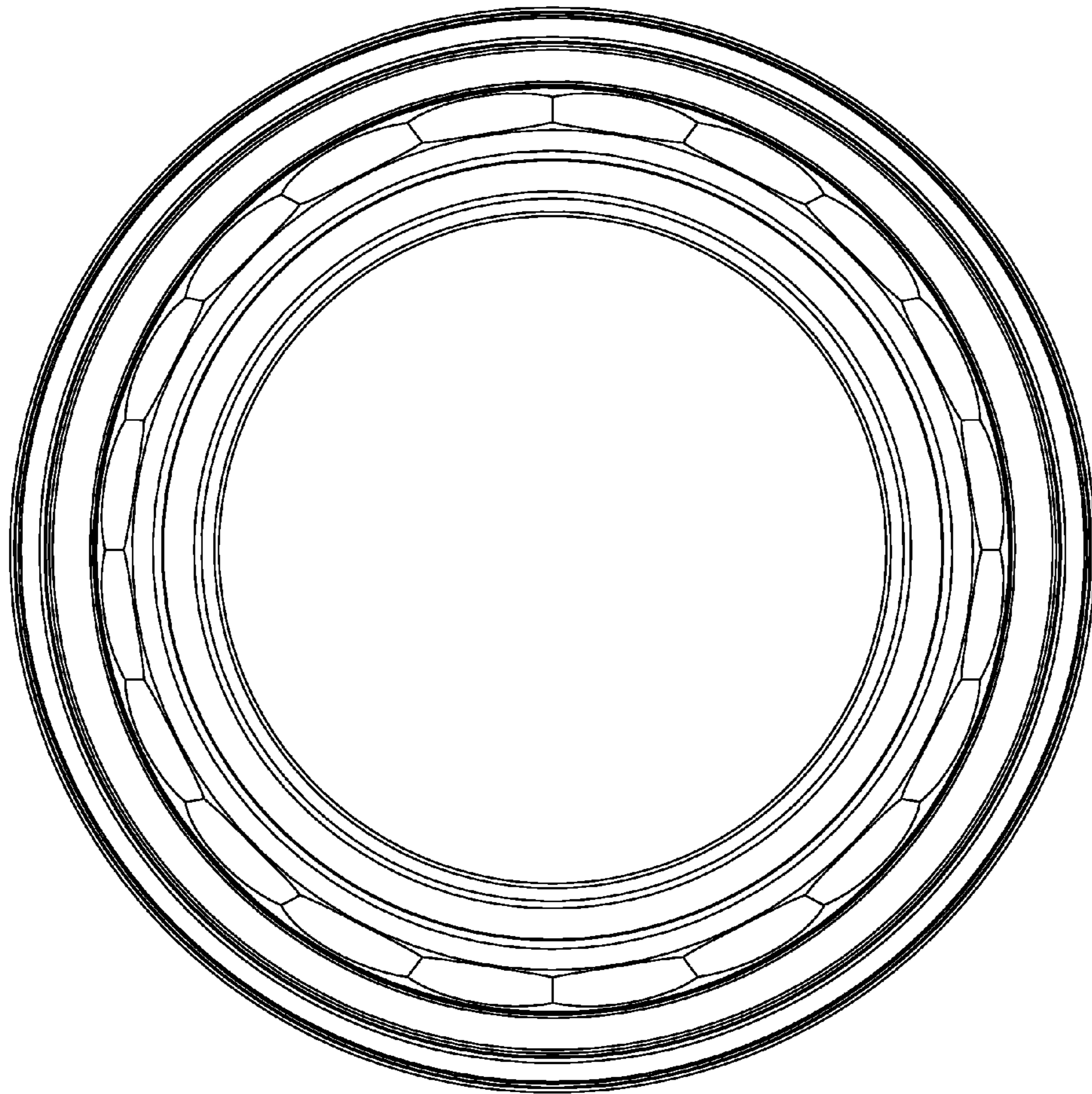

FIG. 7



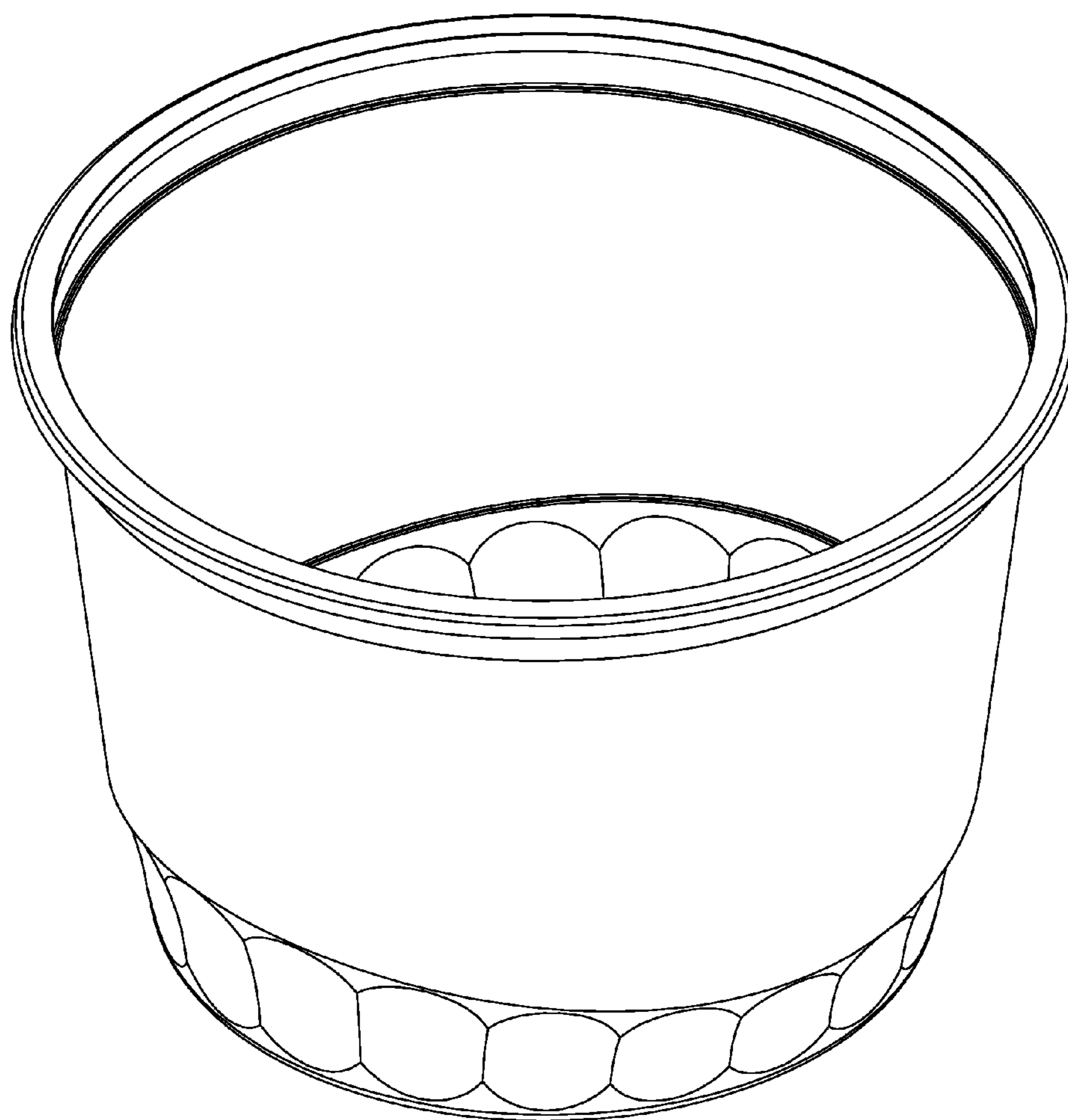

FIG. 8

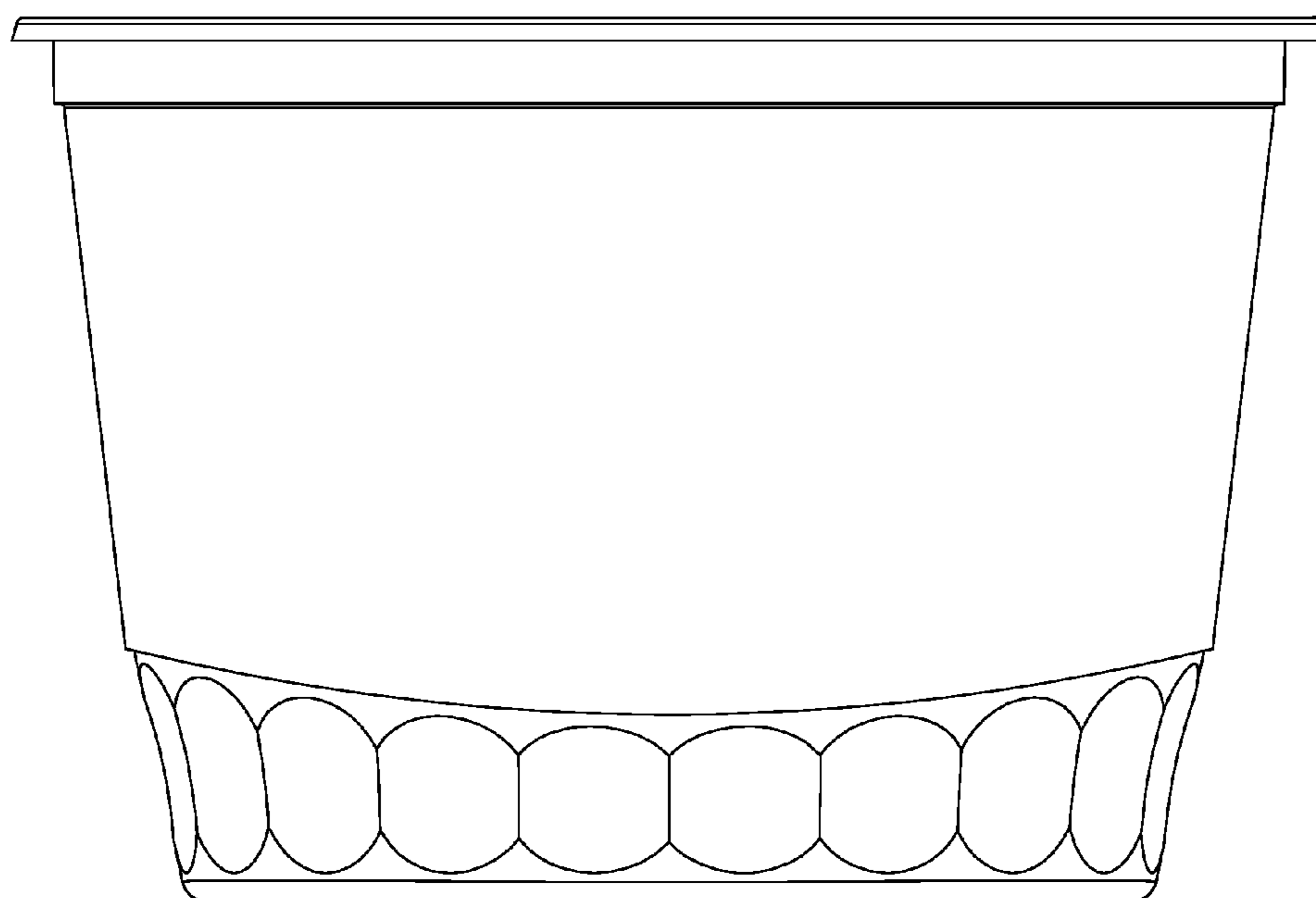

FIG. 9

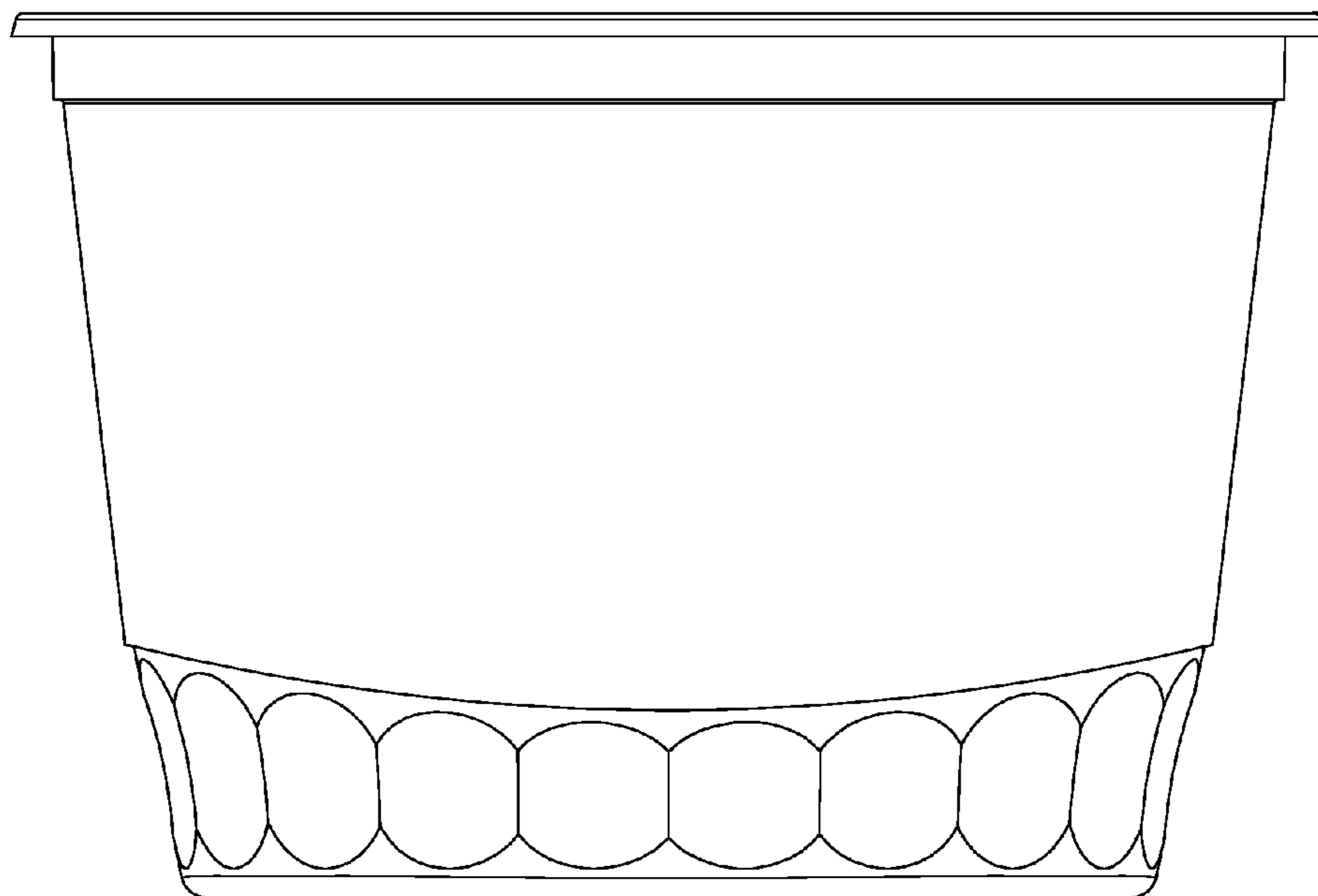

FIG. 10

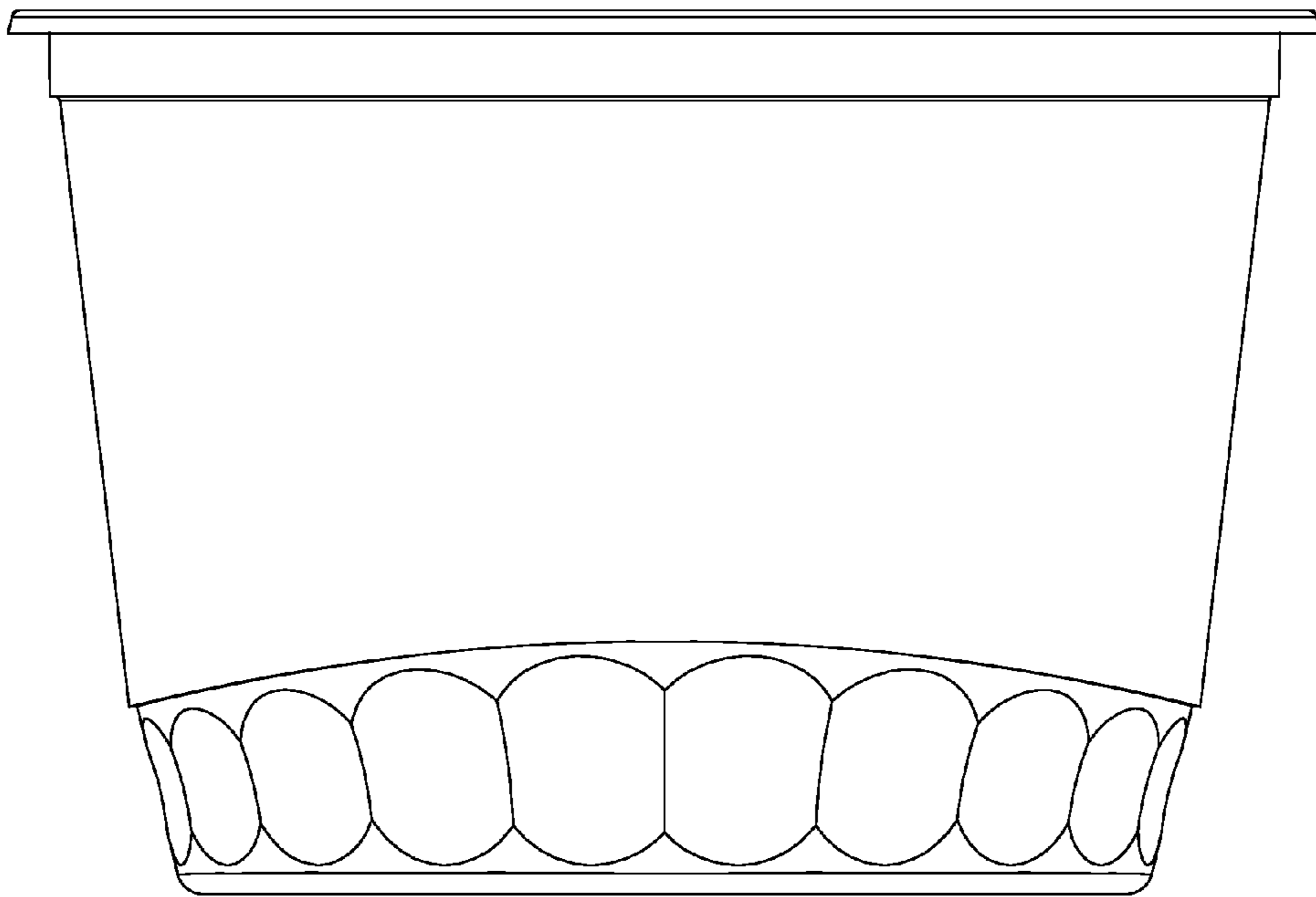

FIG. 11

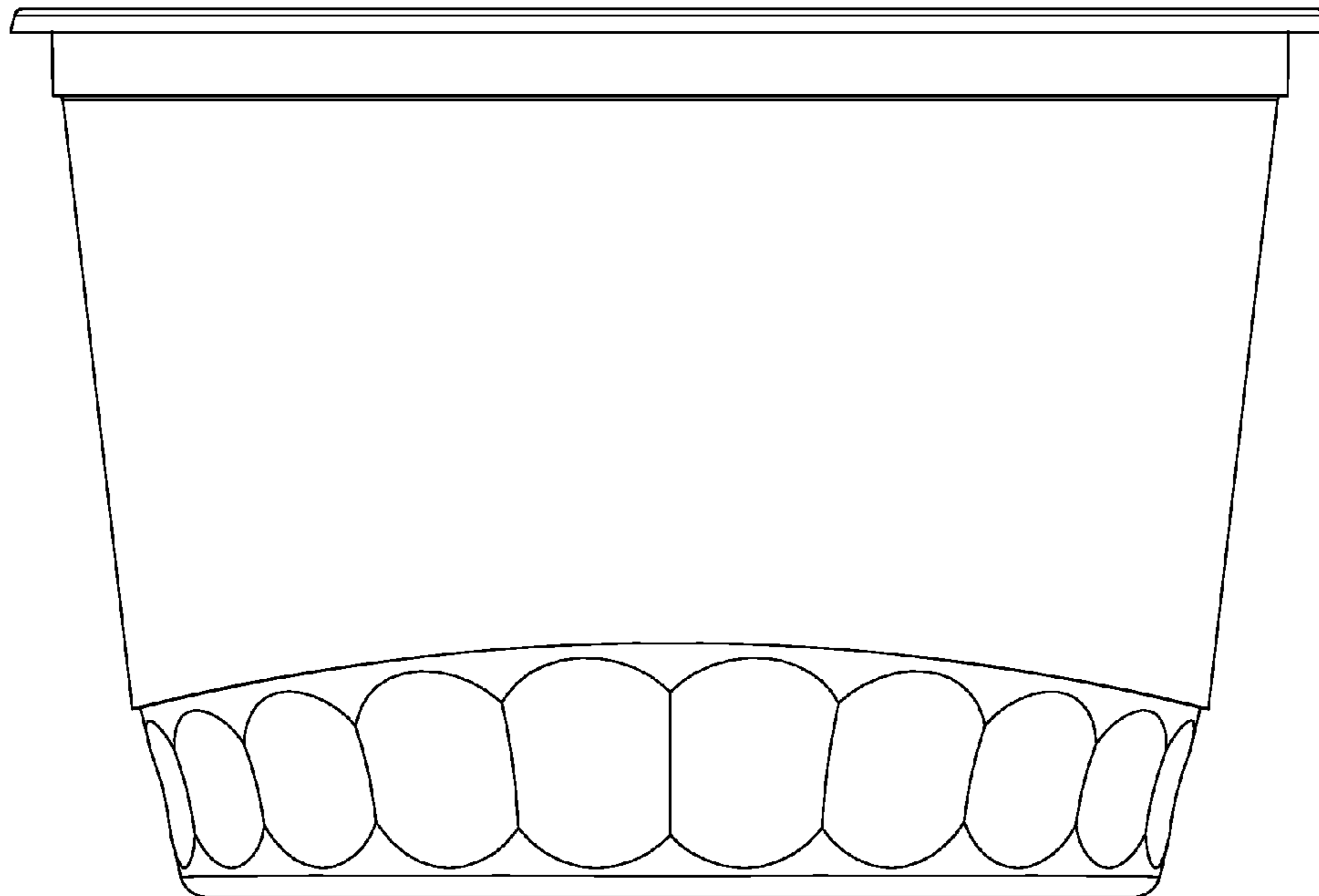

FIG. 12

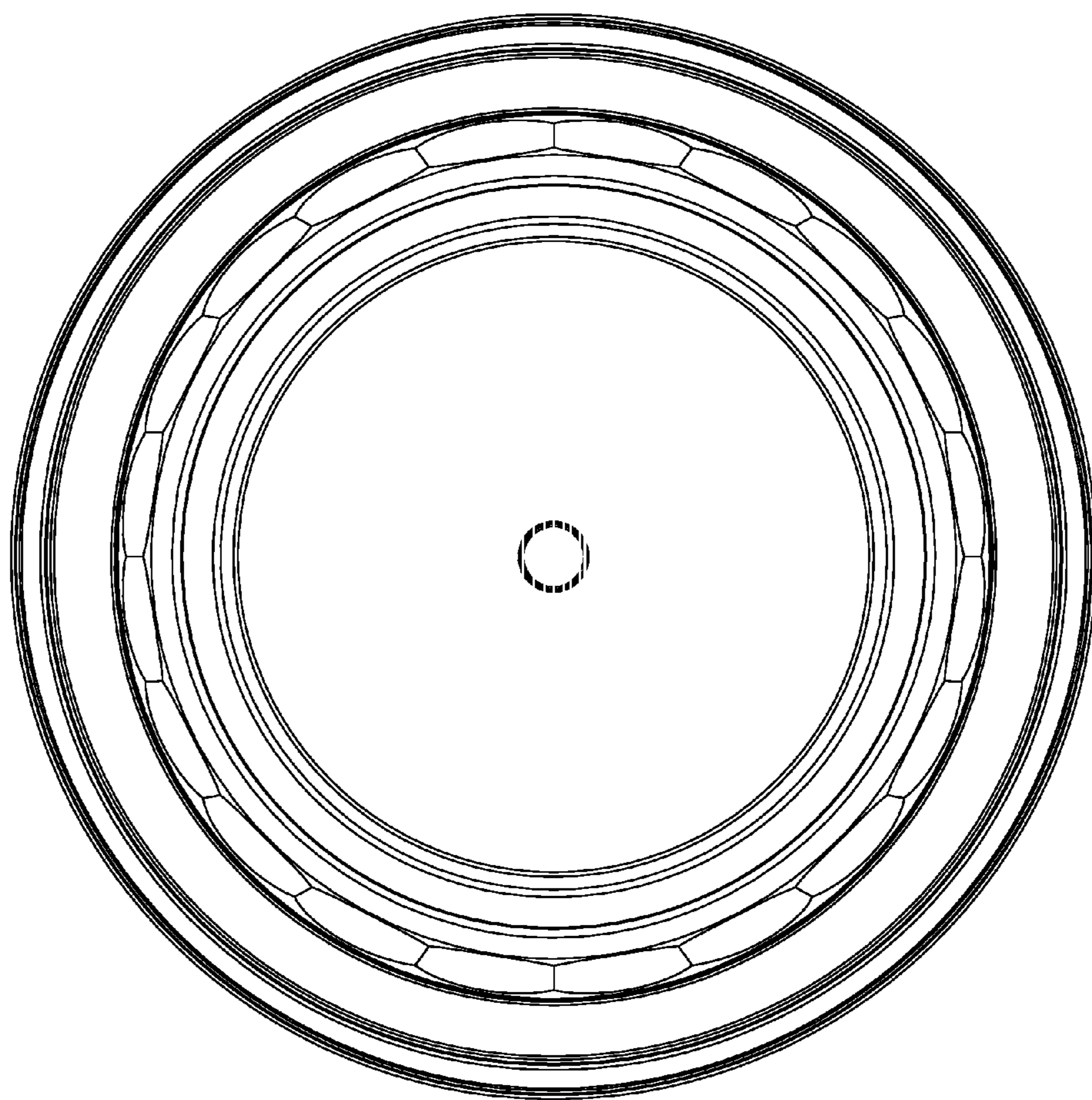

FIG. 13

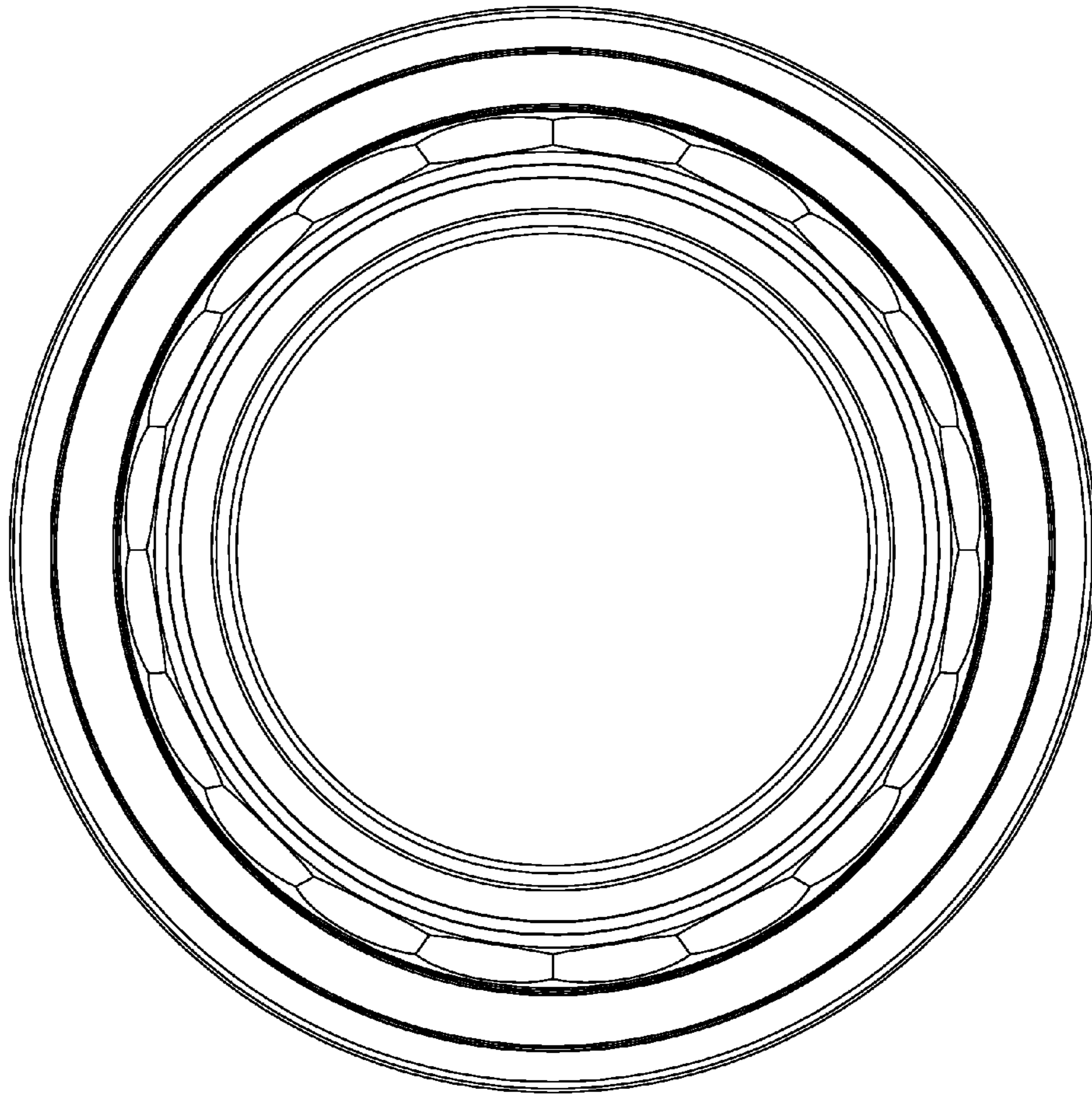

FIG. 14

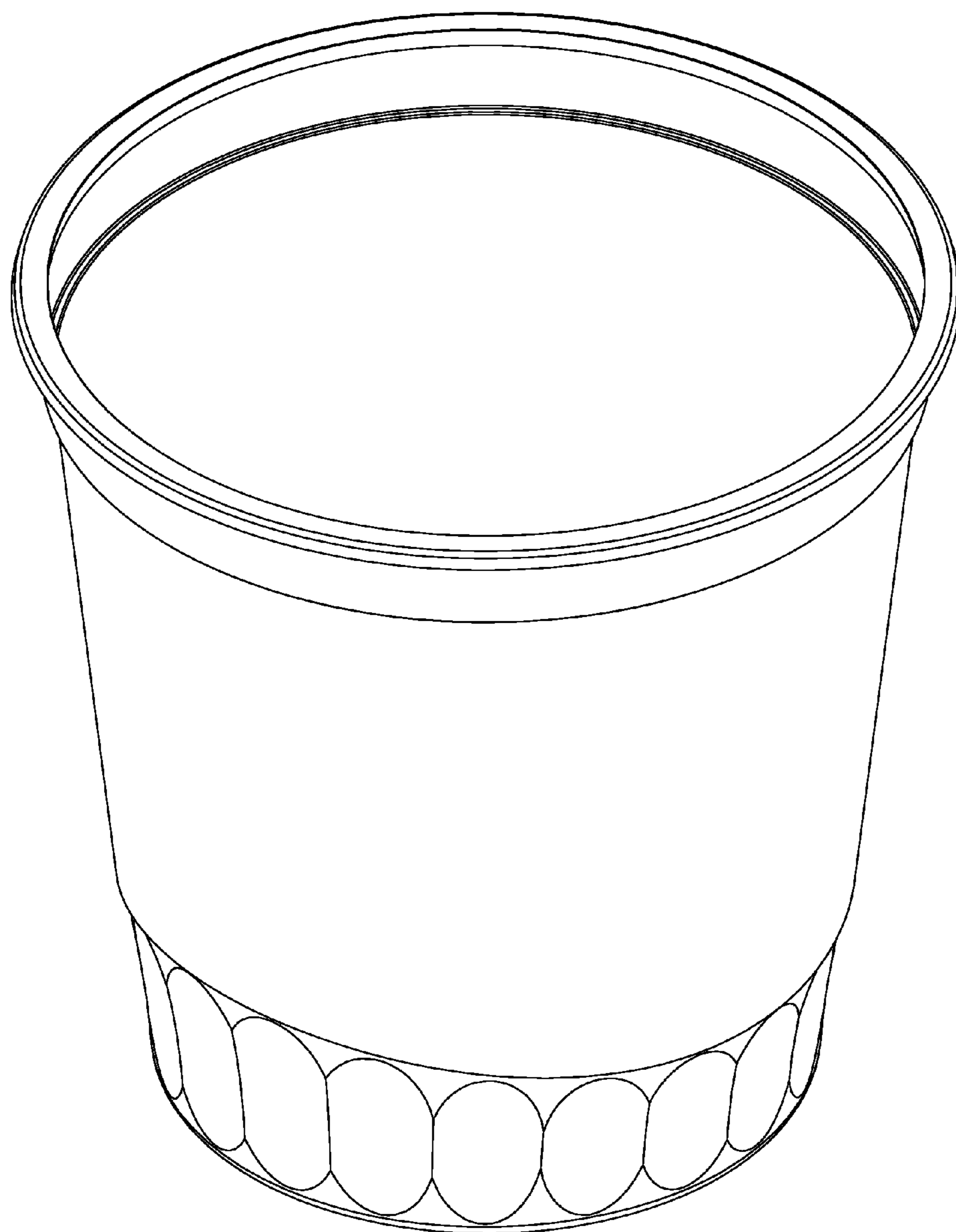

FIG. 15



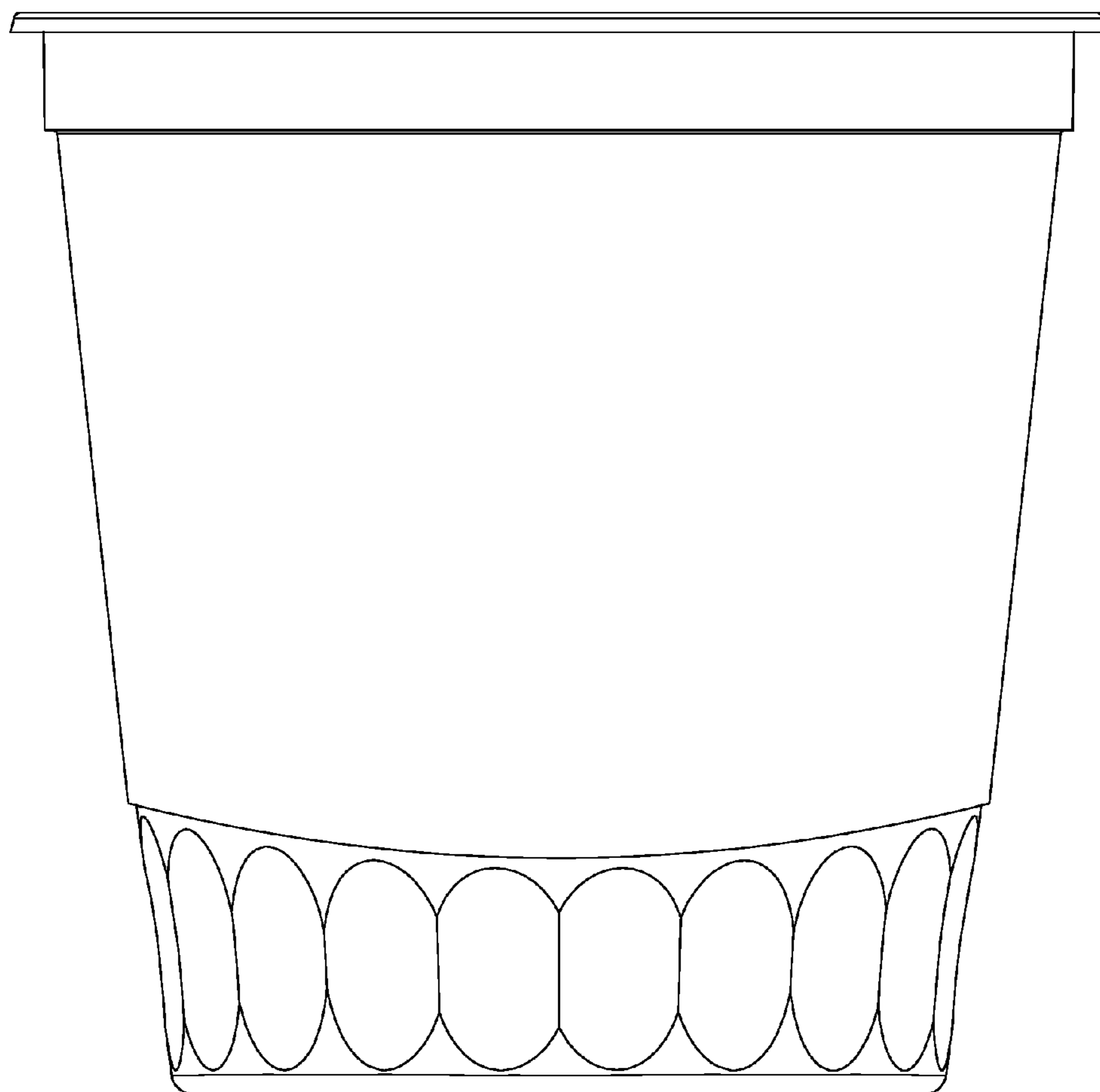

FIG. 16

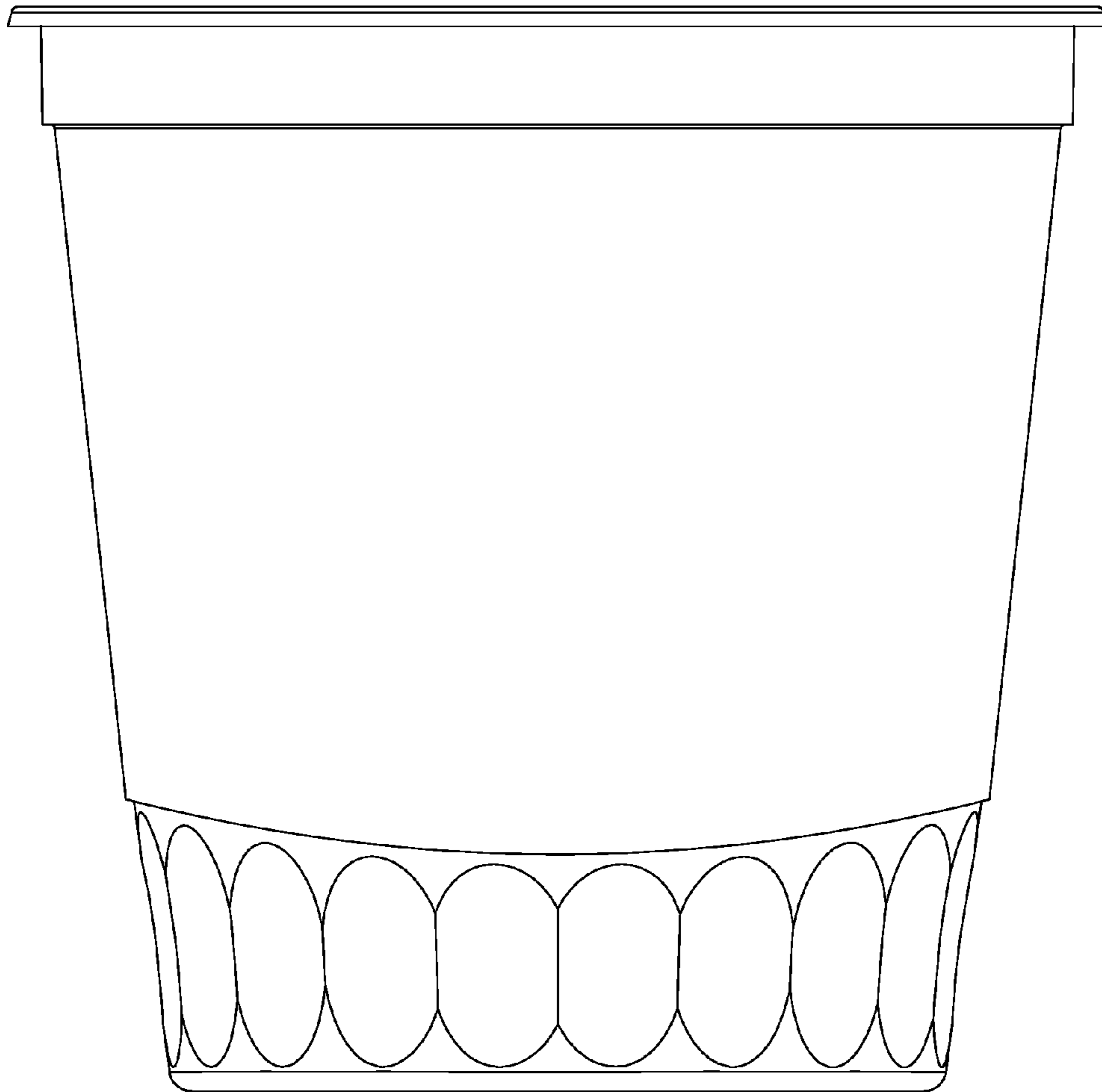

FIG. 17

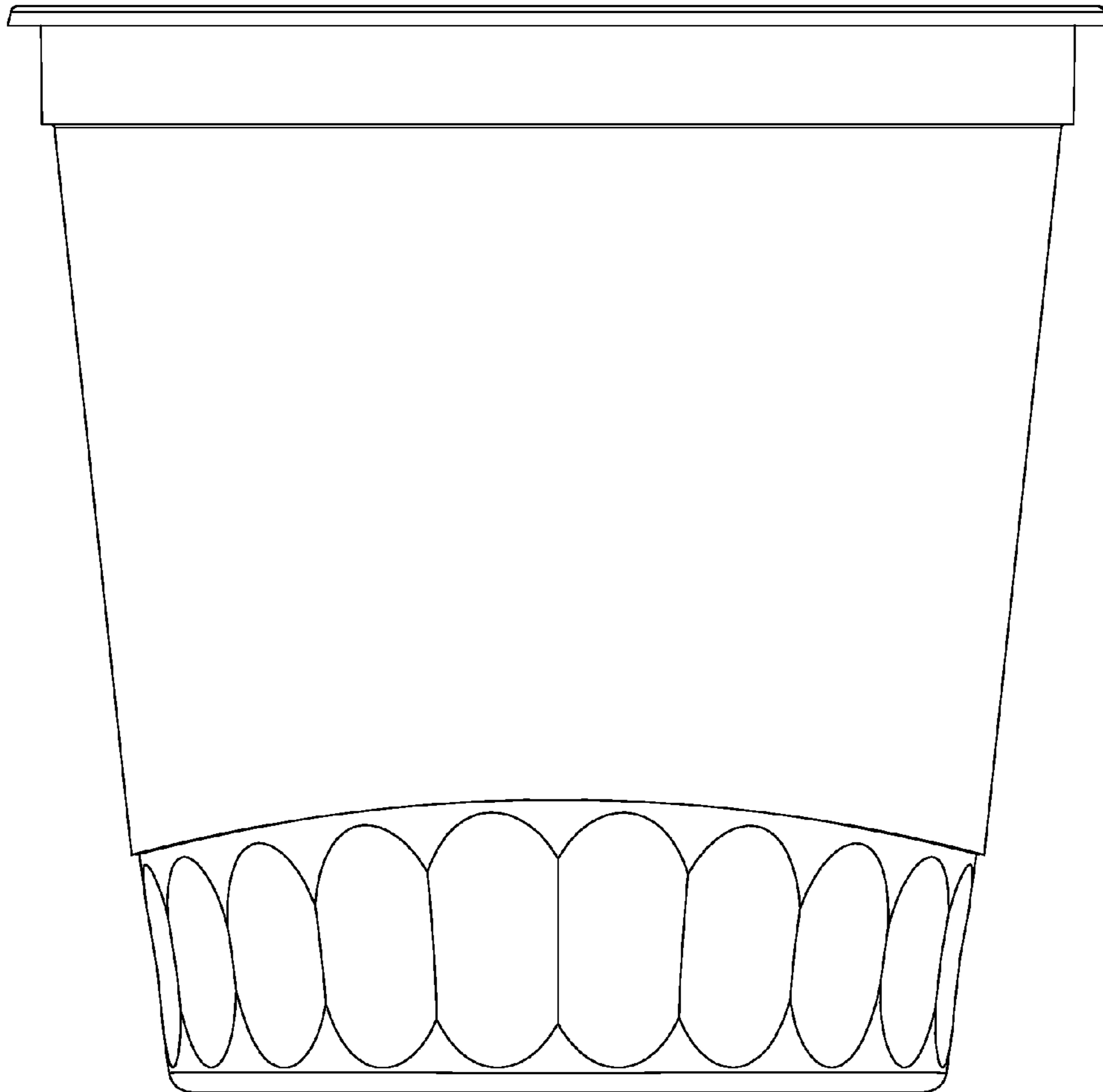

FIG. 18

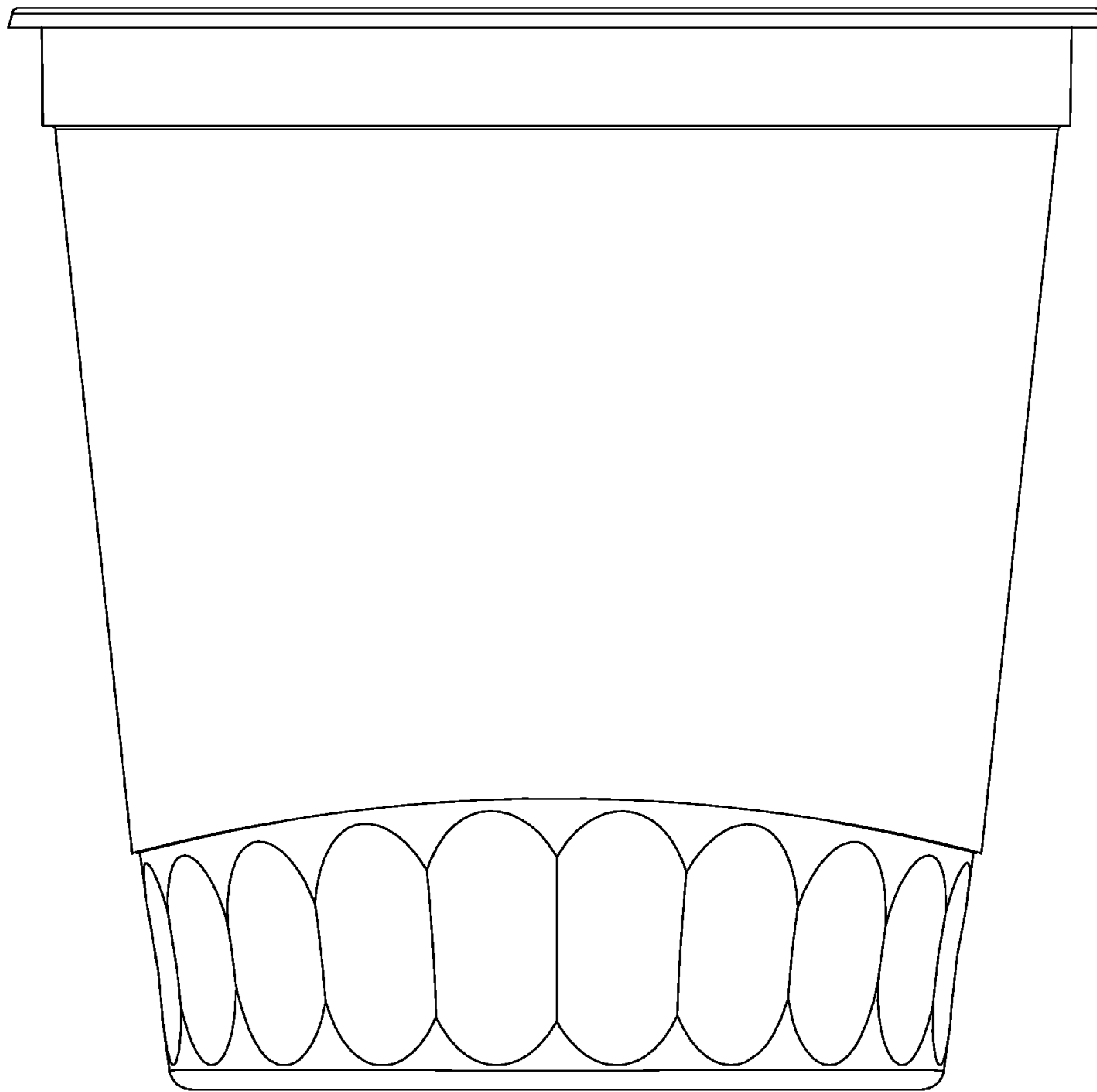

FIG. 19

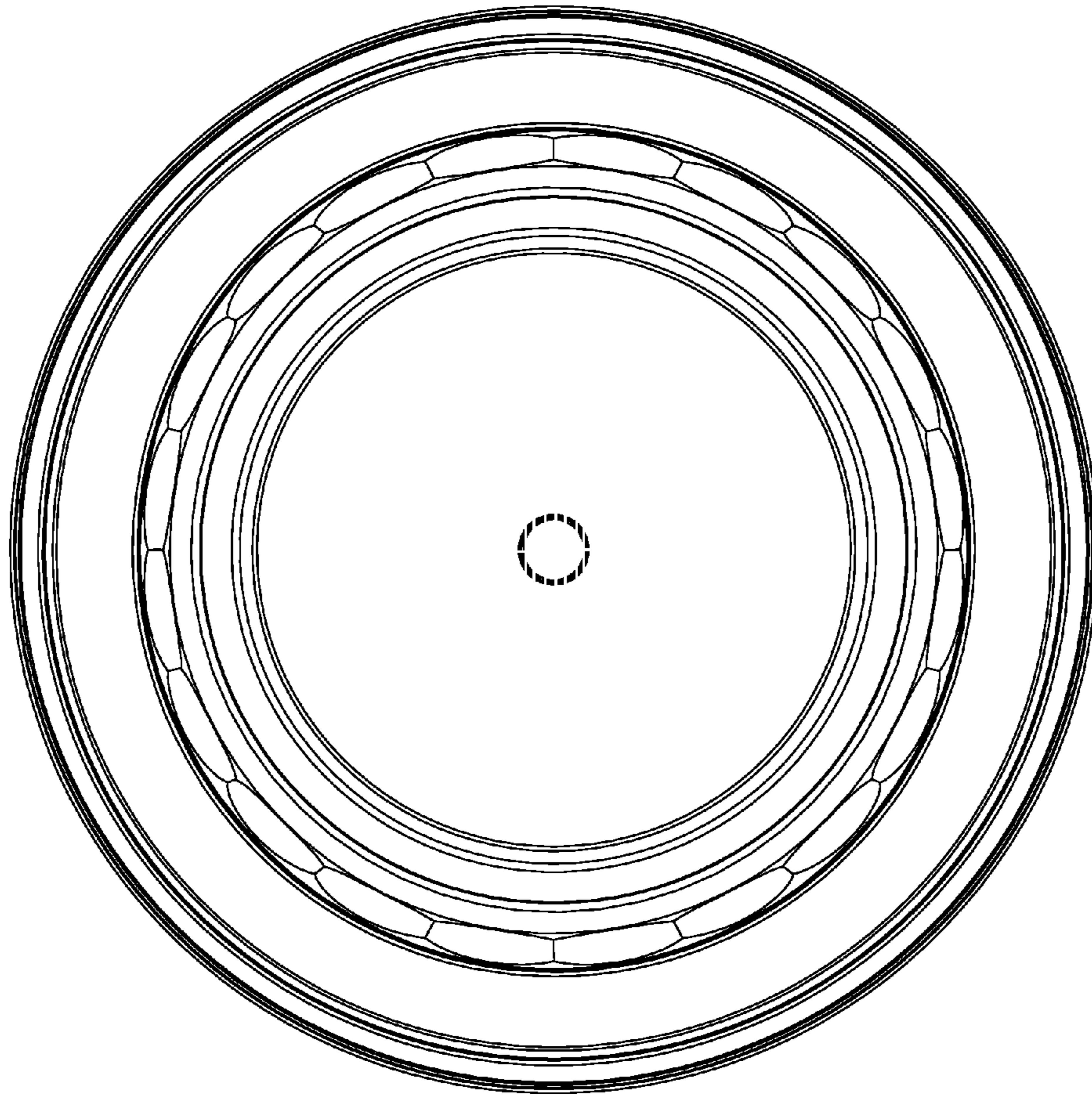

FIG. 20

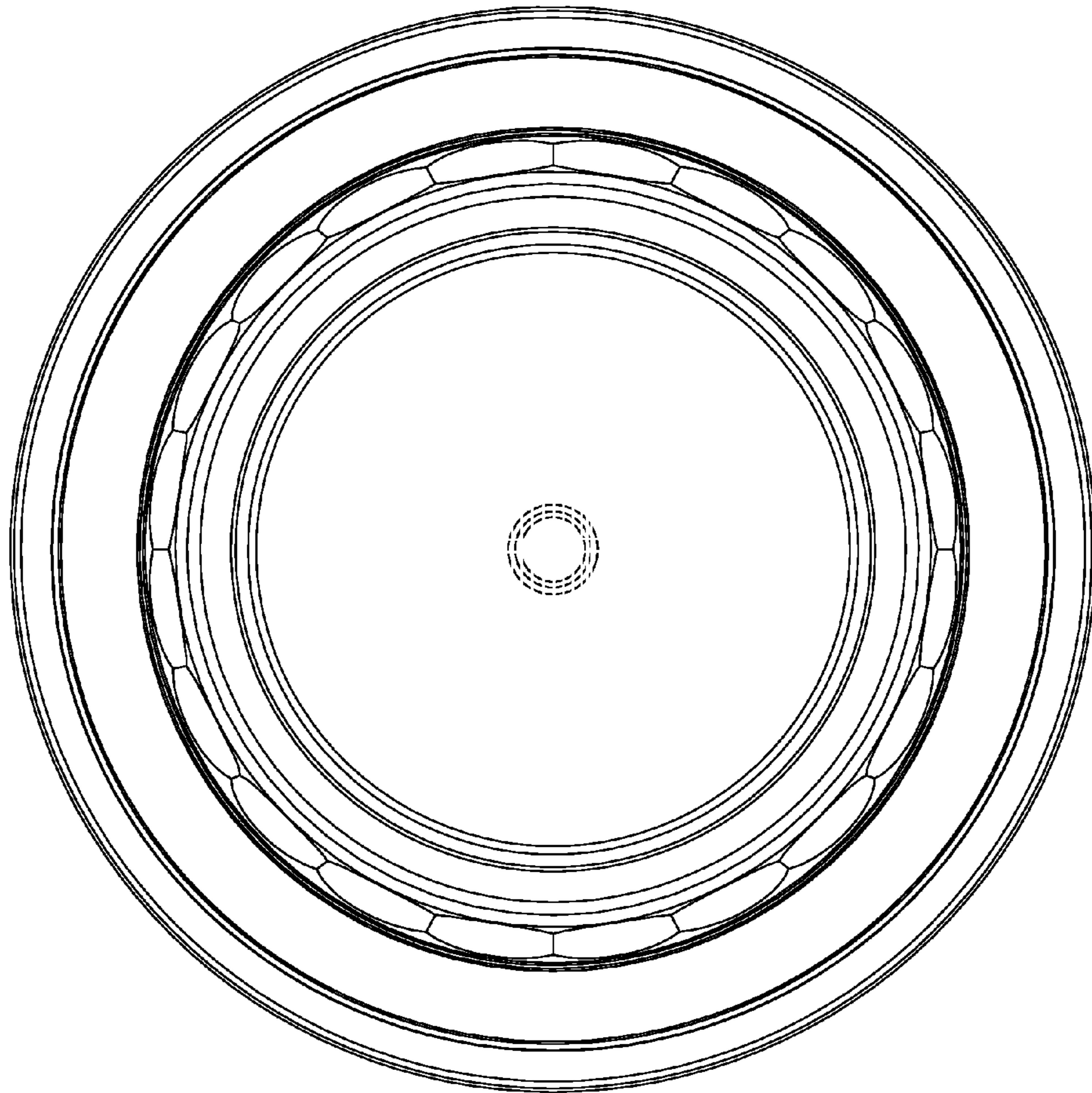

FIG. 21