



US00D694103S

(12) **United States Design Patent**  
**Durdon et al.**

(10) **Patent No.:** **US D694,103 S**  
(45) **Date of Patent:** **\*\* Nov. 26, 2013**

(54) **SINGLE COMPARTMENT CONTAINER**

(75) Inventors: **Terrance N. Durdon**, Brantford (CA);  
**Michael MacDonald**, Waterloo (CA)

(73) Assignee: **Amhil Enterprises**, Mississauga (CA)

(\*\*) Term: **14 Years**

(21) Appl. No.: **29/432,430**

(22) Filed: **Sep. 14, 2012**

(30) **Foreign Application Priority Data**

Jul. 27, 2012 (CA) ..... 146710

(51) **LOC (9) Cl.** ..... **09-03**

(52) **U.S. Cl.**  
USPC ..... **D9/425**

(58) **Field of Classification Search**

USPC ..... D9/424, 425, 432; 206/503, 521.1, 541,  
206/564, 220, 23.8, 23.83, 315, 324, 326,  
206/367, 556, 835; D3/203.2, 294; D7/601,  
D7/602, 629, 538-542, 612-615;  
220/780-806, 574-575, 4.24

See application file for complete search history.

(56) **References Cited**

**U.S. PATENT DOCUMENTS**

D386,081 S \* 11/1997 Hayes et al. .... D9/425

D392,881 S \* 3/1998 Bulcher et al. .... D9/425

(Continued)

*Primary Examiner* — Thomas Johannes

(74) *Attorney, Agent, or Firm* — Gerald A. Gowan; Gowan  
Intellectual Property

(57) **CLAIM**

The ornamental design for a single compartment container, as  
shown and described.

**DESCRIPTION**

FIG. 1 is a perspective view of a first embodiment of a single  
compartment container of the present design;

FIG. 2 is a bottom view thereof;

FIG. 3 is a right side view thereof;

FIG. 4 is a back view thereof;

FIG. 5 is a top view thereof;

FIG. 6 is a front view thereof;

FIG. 7 is a left side view thereof;

FIG. 8 is a perspective view of a second embodiment of a  
single compartment container of the present design;

FIG. 9 is a bottom view thereof;

FIG. 10 is a right side view thereof;

FIG. 11 is a back view thereof;

FIG. 12 is a top view thereof;

FIG. 13 is a front view thereof;

FIG. 14 is a left side view thereof;

FIG. 15 is a perspective view of a third embodiment of a  
single compartment container of the present design;

FIG. 16 is a bottom view thereof;

FIG. 17 is a right side view thereof;

FIG. 18 is a back view thereof;

FIG. 19 is a top view thereof;

FIG. 20 is a front view thereof;

FIG. 21 is a left side view thereof;

FIG. 22 is a perspective view of a fourth embodiment of a  
single compartment container of the present design;

FIG. 23 is a bottom view thereof;

FIG. 24 is a right side view thereof;

FIG. 25 is a back view thereof;

FIG. 26 is a top view thereof;

FIG. 27 is a front view thereof;

FIG. 28 is a left side view thereof;

FIG. 29 is a perspective view of a fifth embodiment of a single  
compartment container of the present design;

FIG. 30 is a bottom view thereof;

FIG. 31 is a right side view thereof;

FIG. 32 is a back view thereof;

FIG. 33 is a top view thereof;

FIG. 34 is a front view thereof;

FIG. 35 is a left side view thereof;

FIG. 36 is a perspective view of a sixth embodiment of a  
single compartment container of the present design;

FIG. 37 is a bottom view thereof;

FIG. 38 is a right side view thereof;

FIG. 39 is a back view thereof;

FIG. 40 is a top view thereof;

FIG. 41 is a front view thereof; and,

FIG. 42 is a left side view thereof.

**1 Claim, 12 Drawing Sheets**

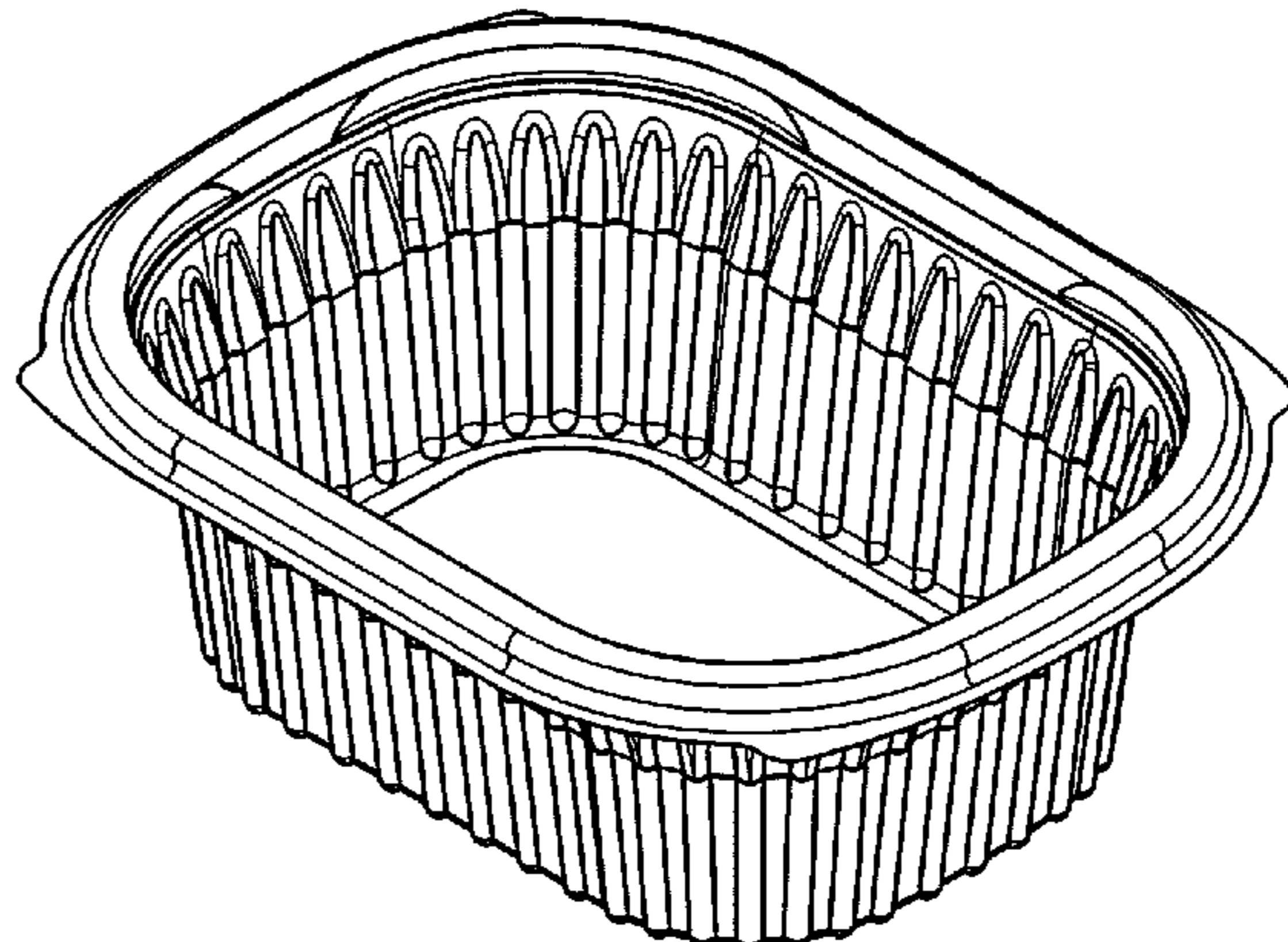
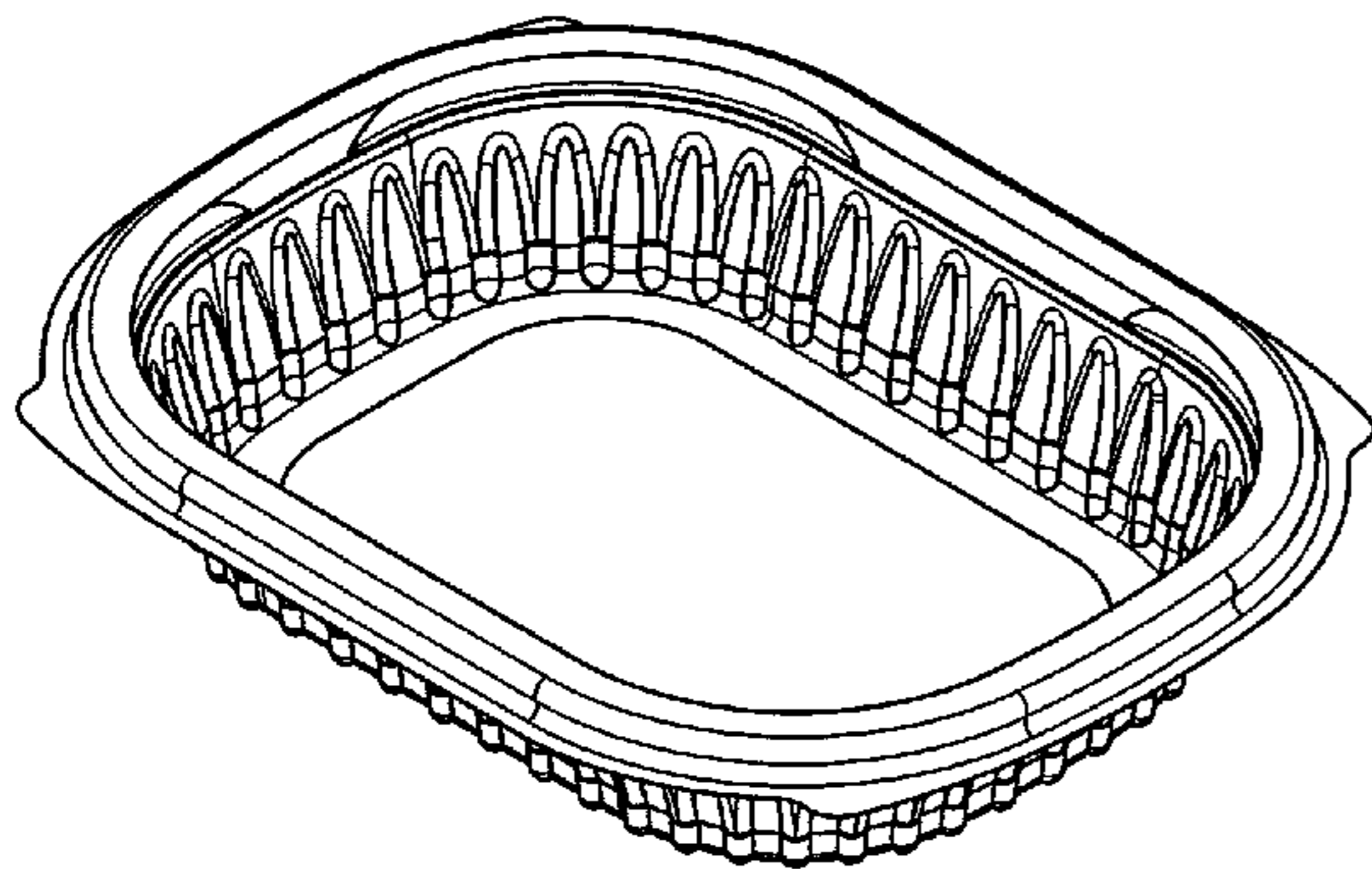

# US D694,103 S

Page 2

---

(56)

## References Cited

D553,490 S \* 10/2007 Yang ..... D9/425  
D625,180 S \* 10/2010 Enriquez ..... D9/425

## U.S. PATENT DOCUMENTS

D470,048 S \* 2/2003 Buchalski et al. .... D9/425 \* cited by examiner

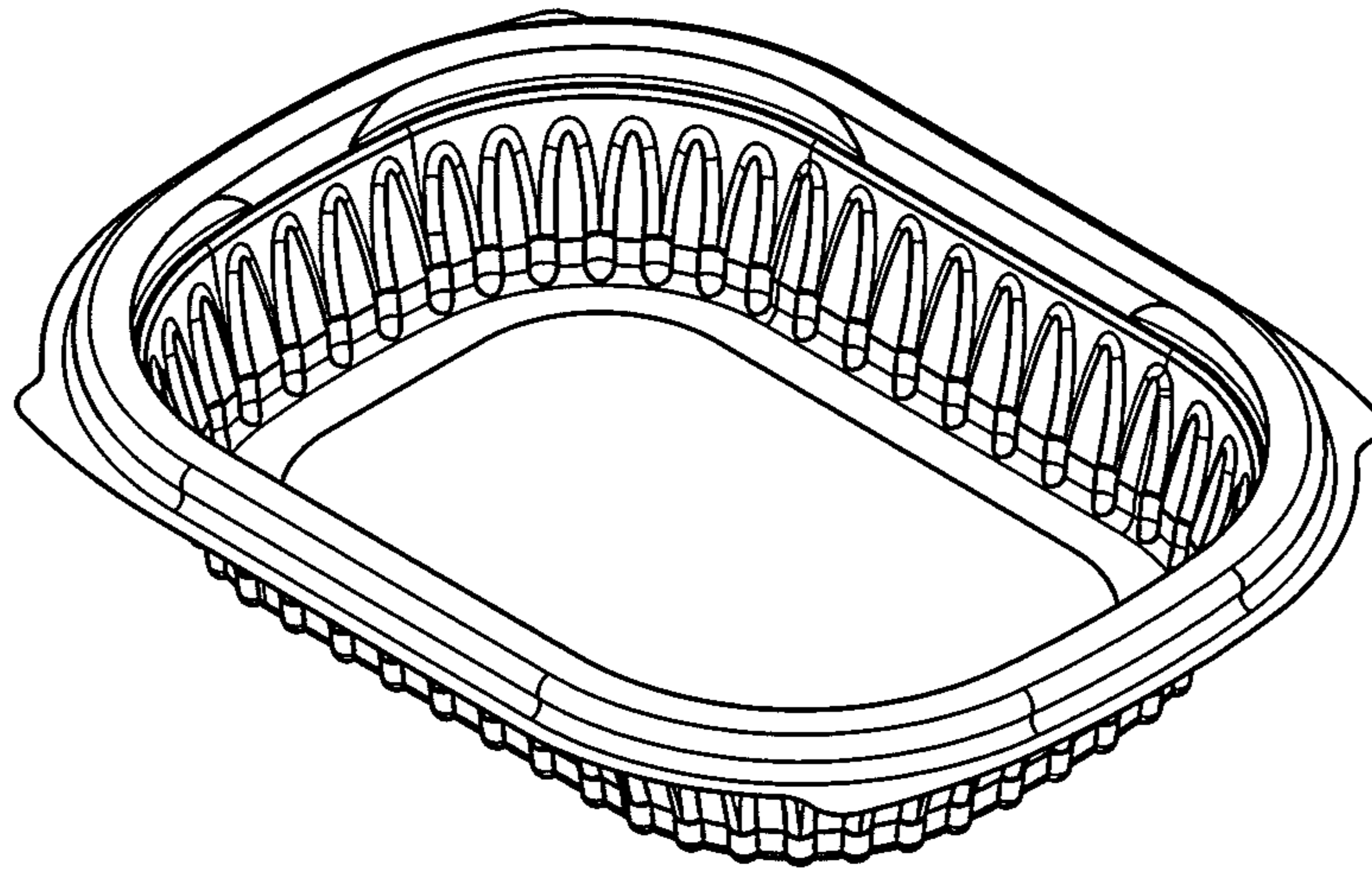

FIGURE #1

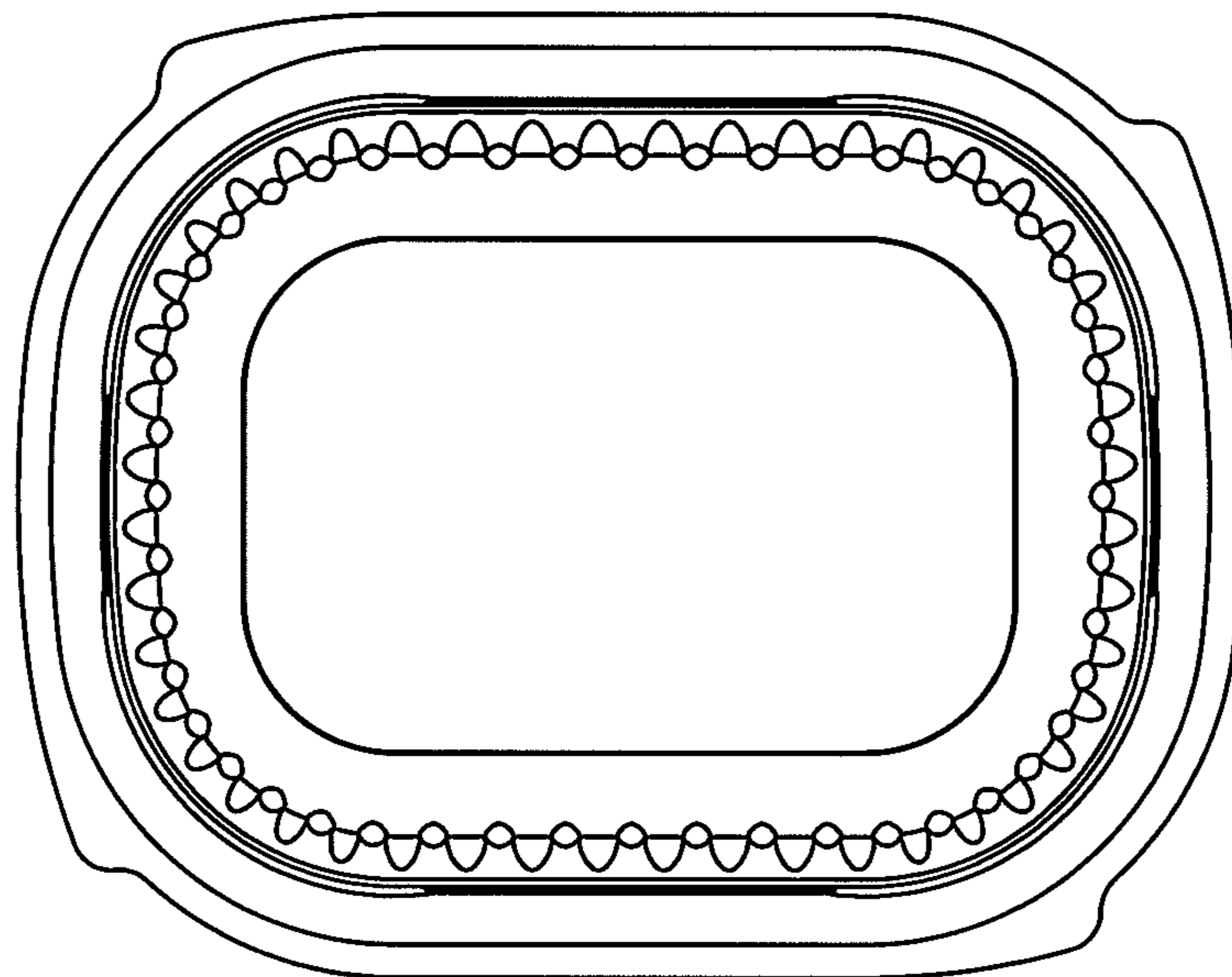

FIGURE #2

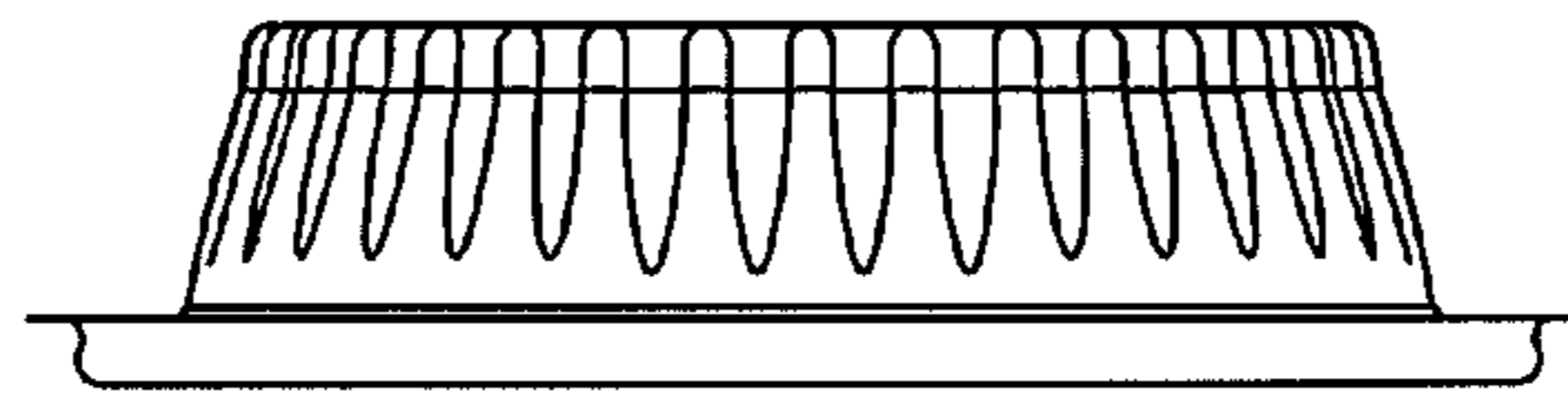

FIGURE #3

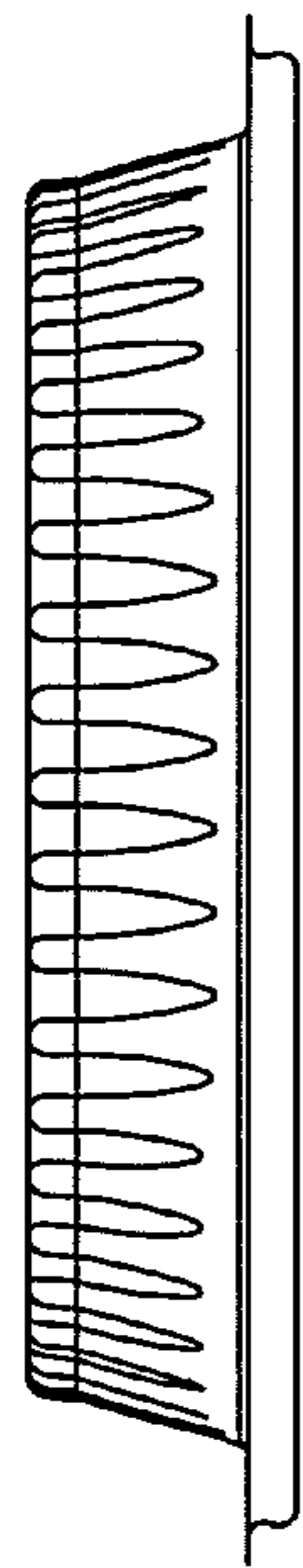

FIGURE #4

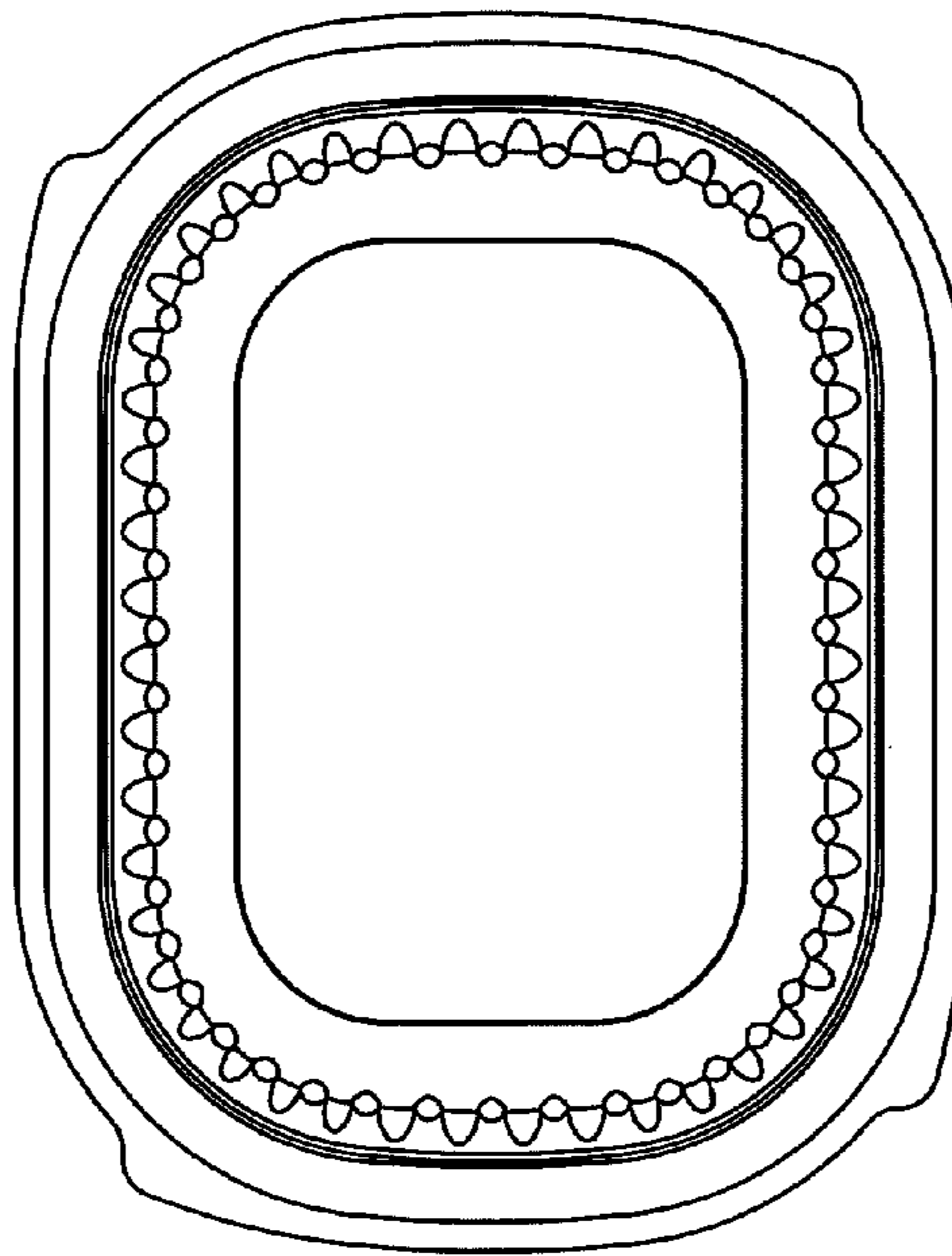

FIGURE #5

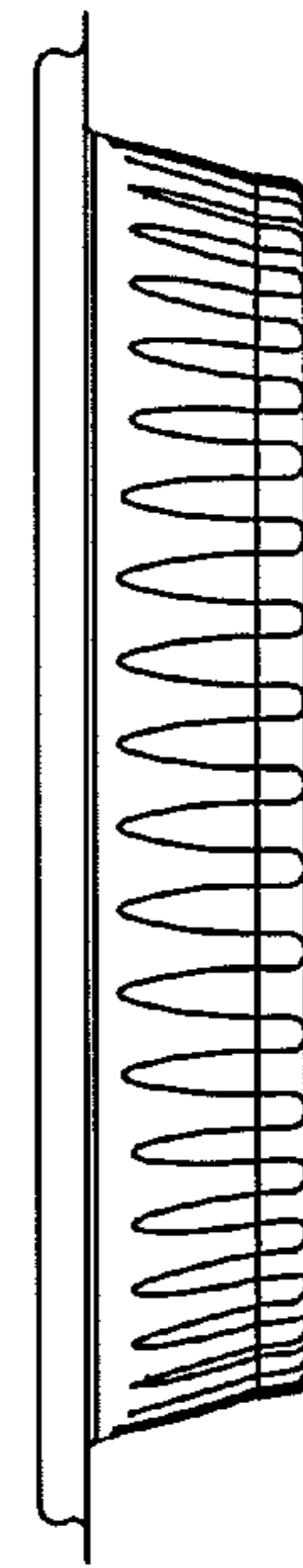

FIGURE #6

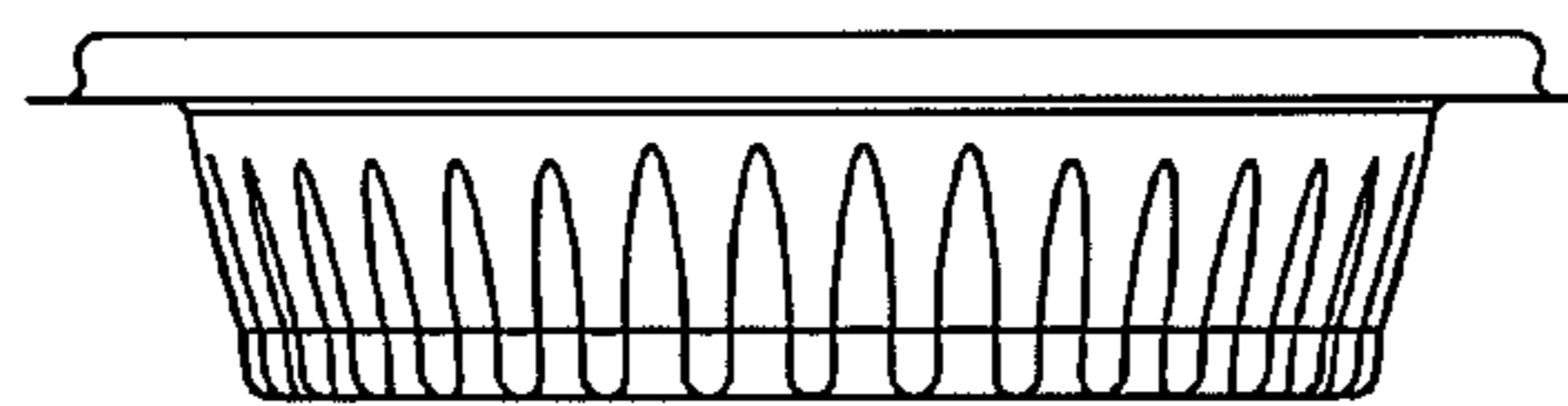

FIGURE #7

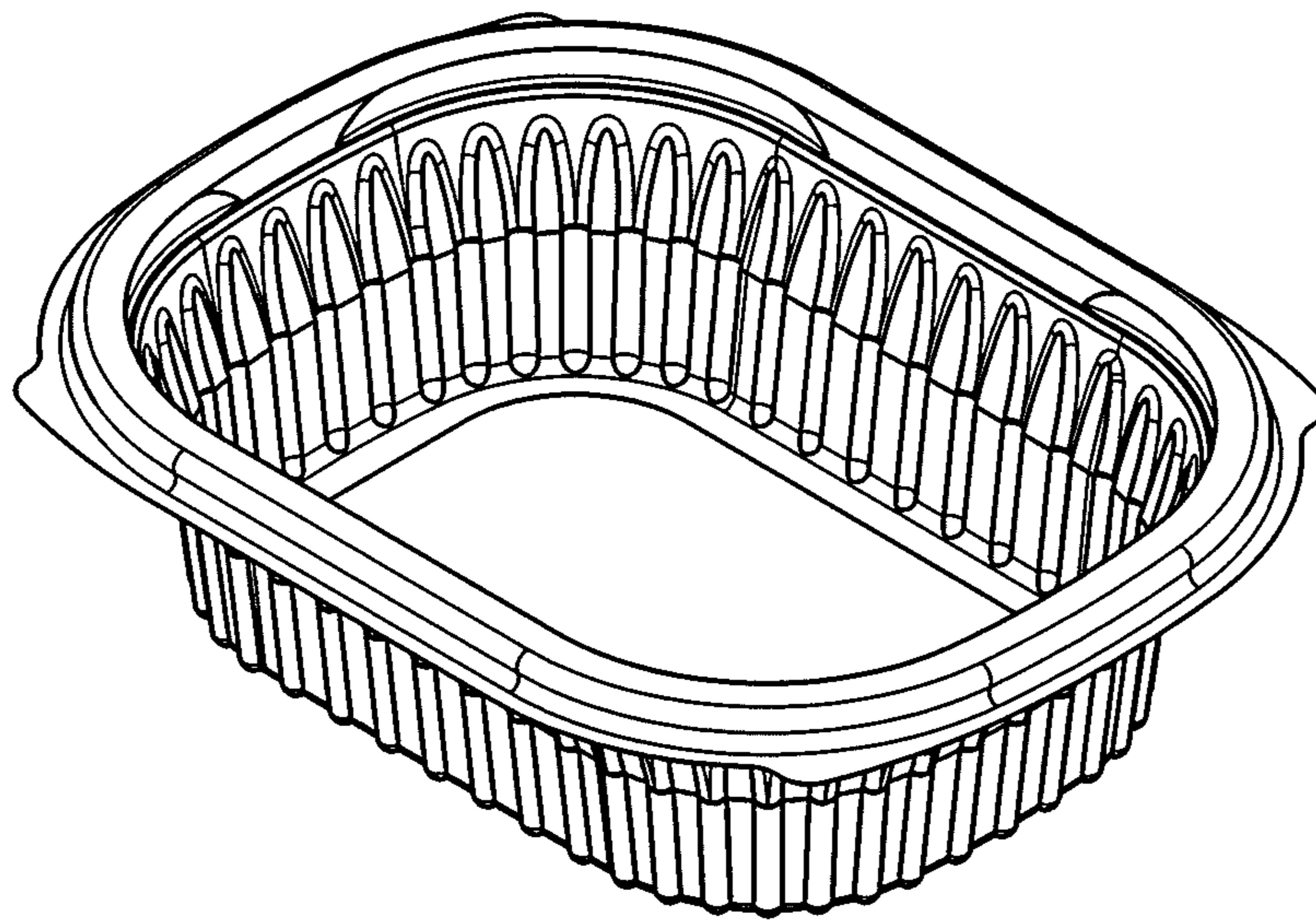

FIGURE #8

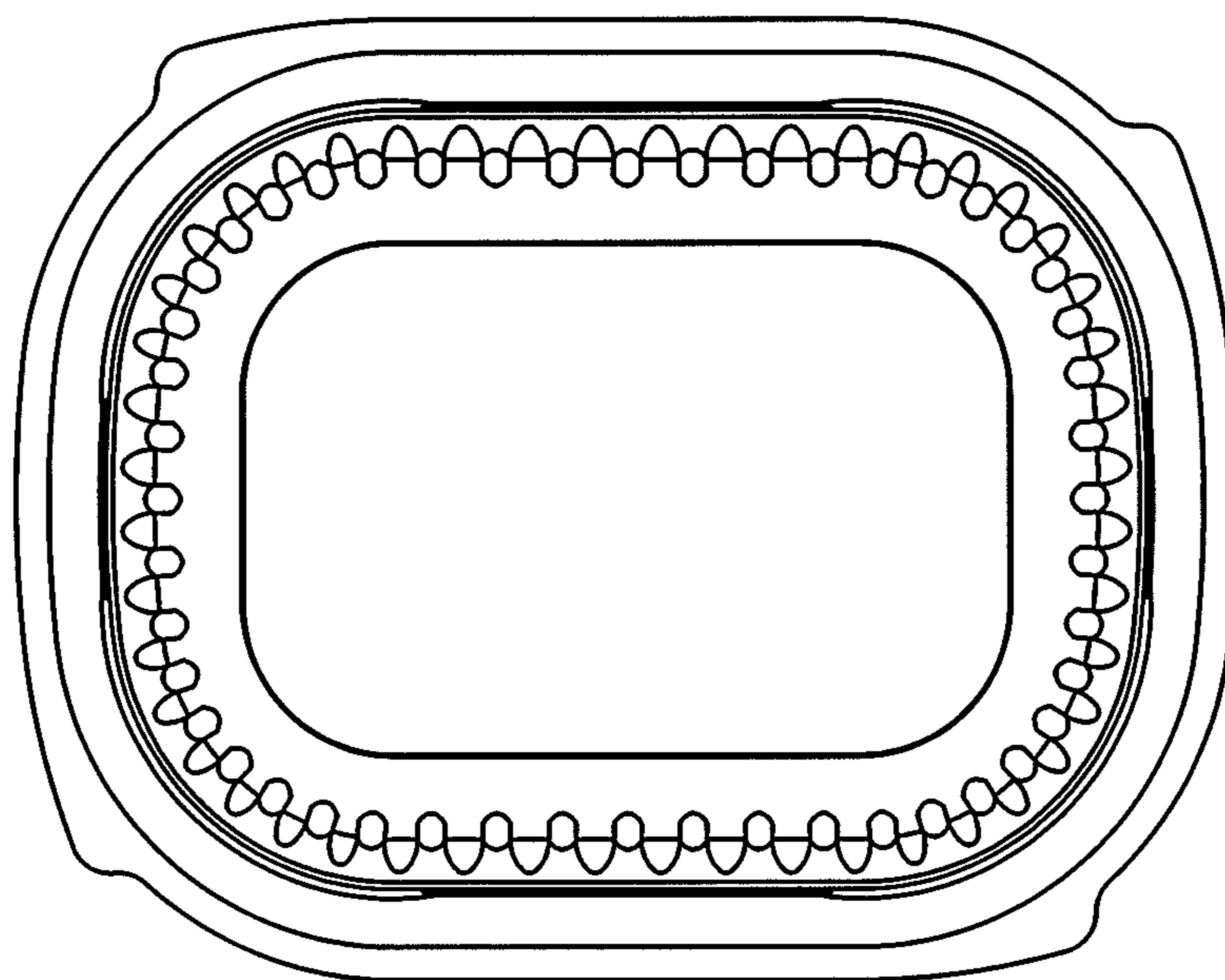

FIGURE #9

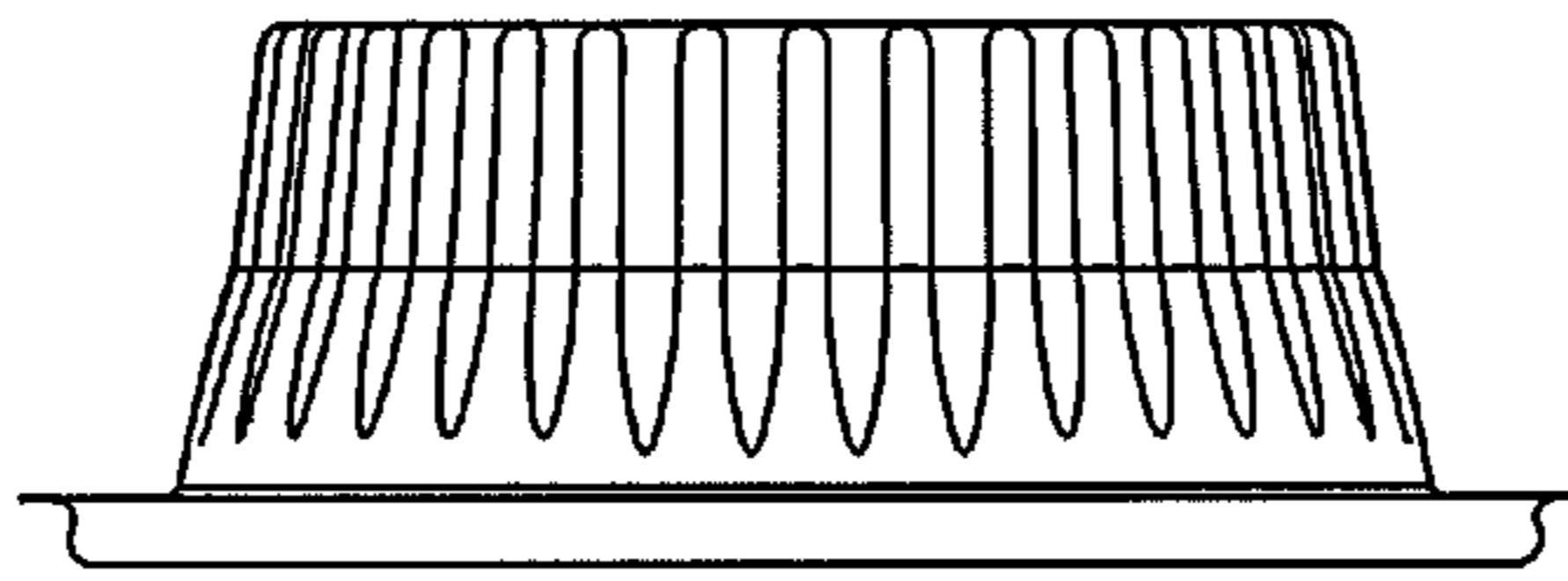

FIGURE #10

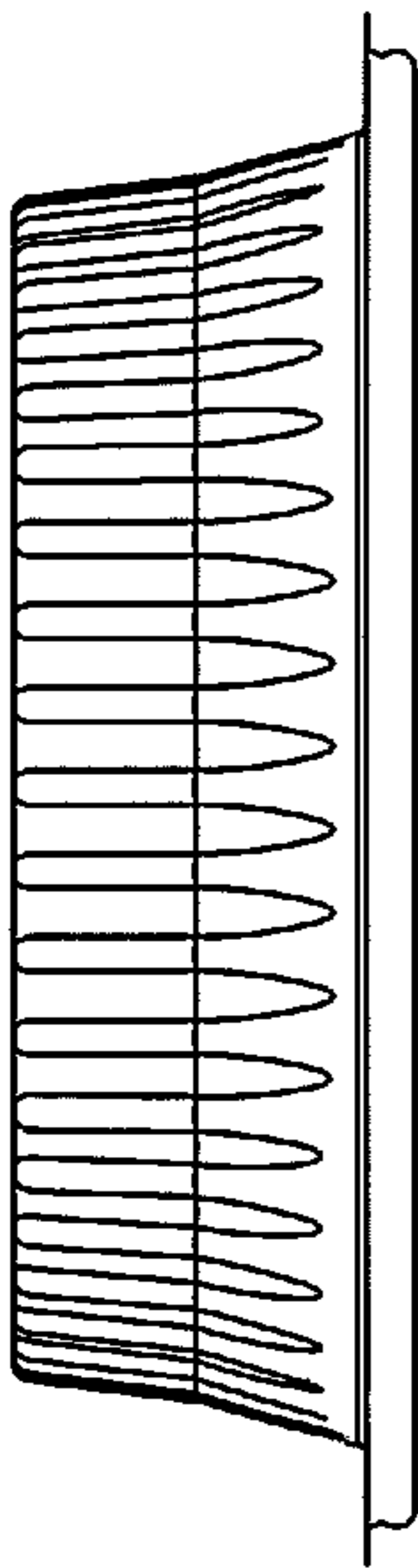

FIGURE #11

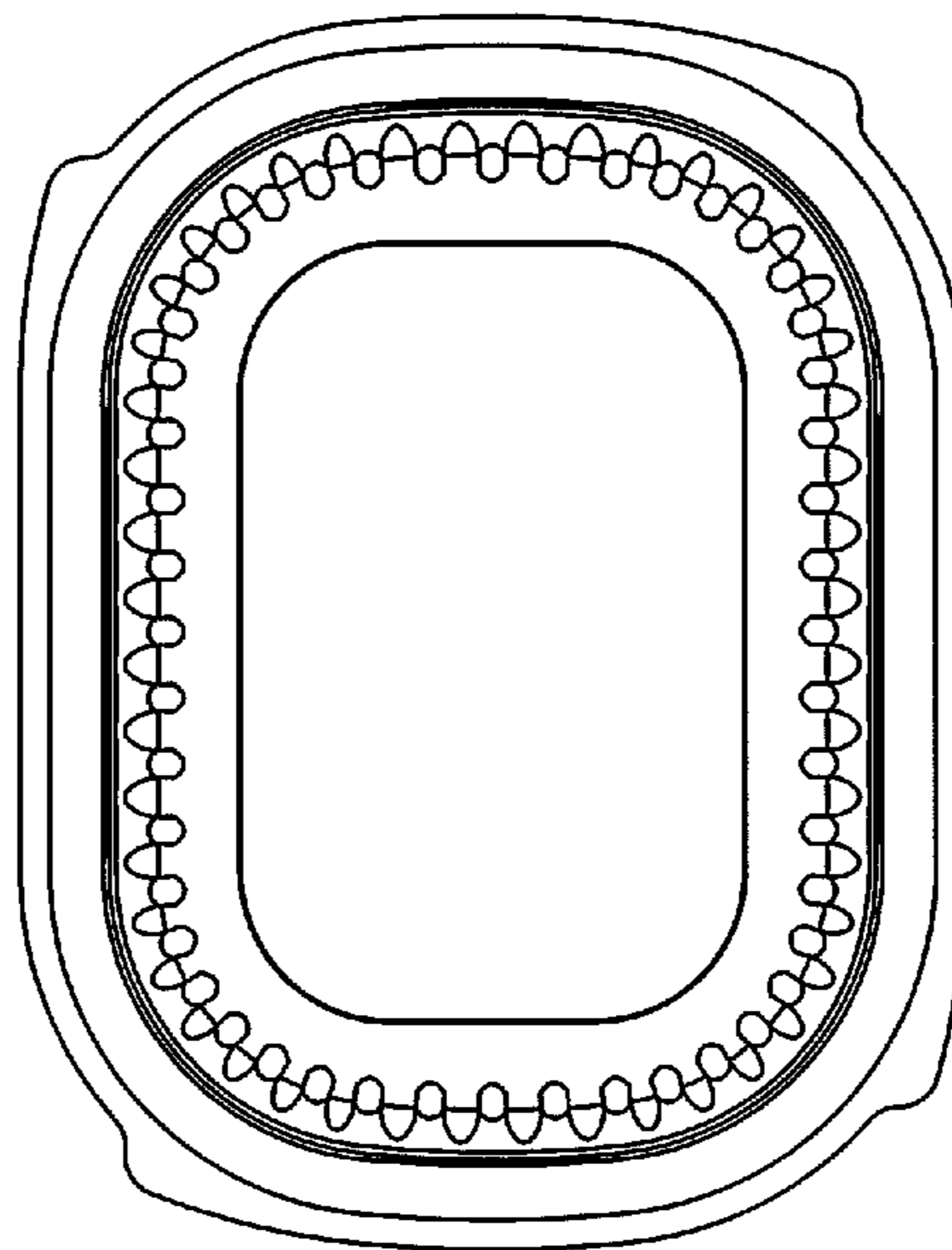

FIGURE #12

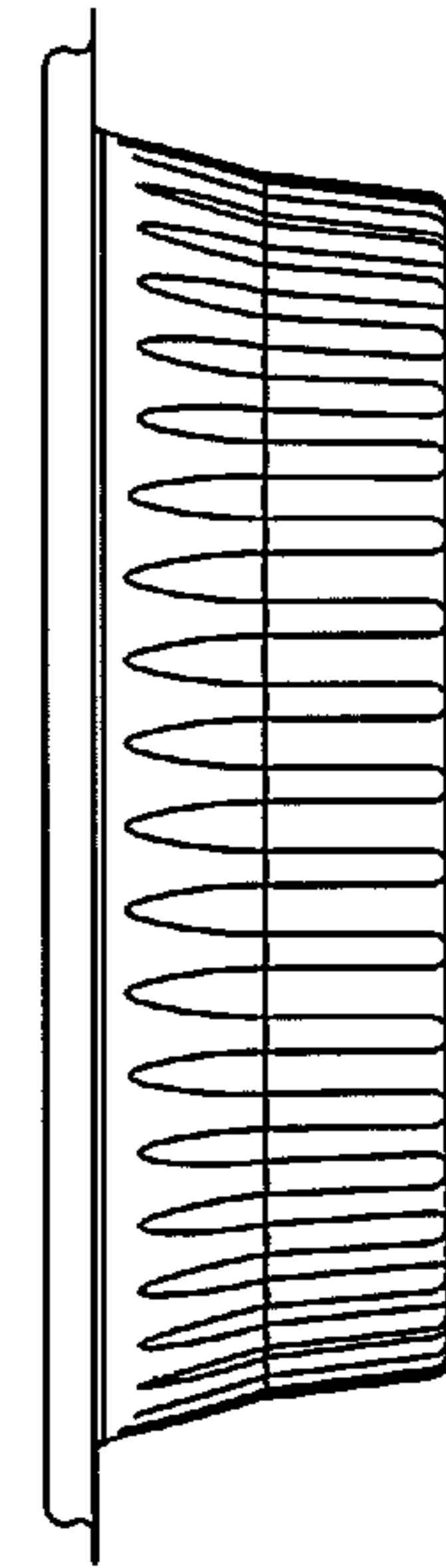

FIGURE #13

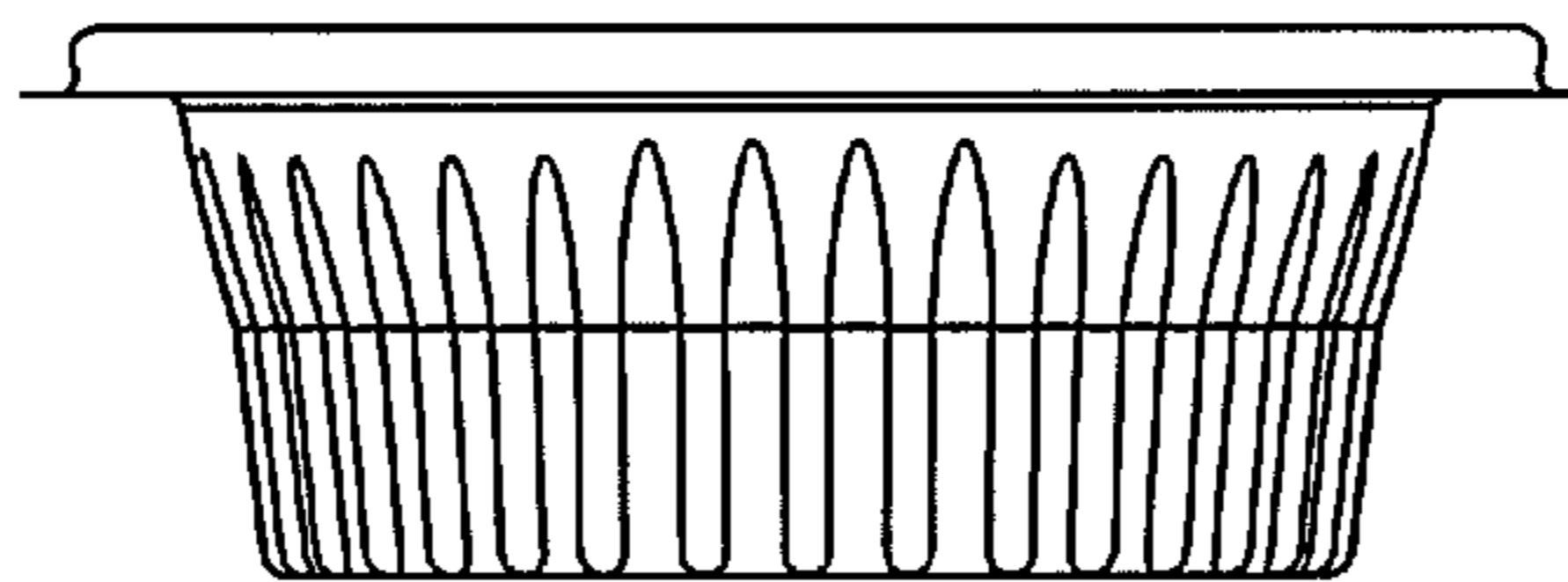

FIGURE #14

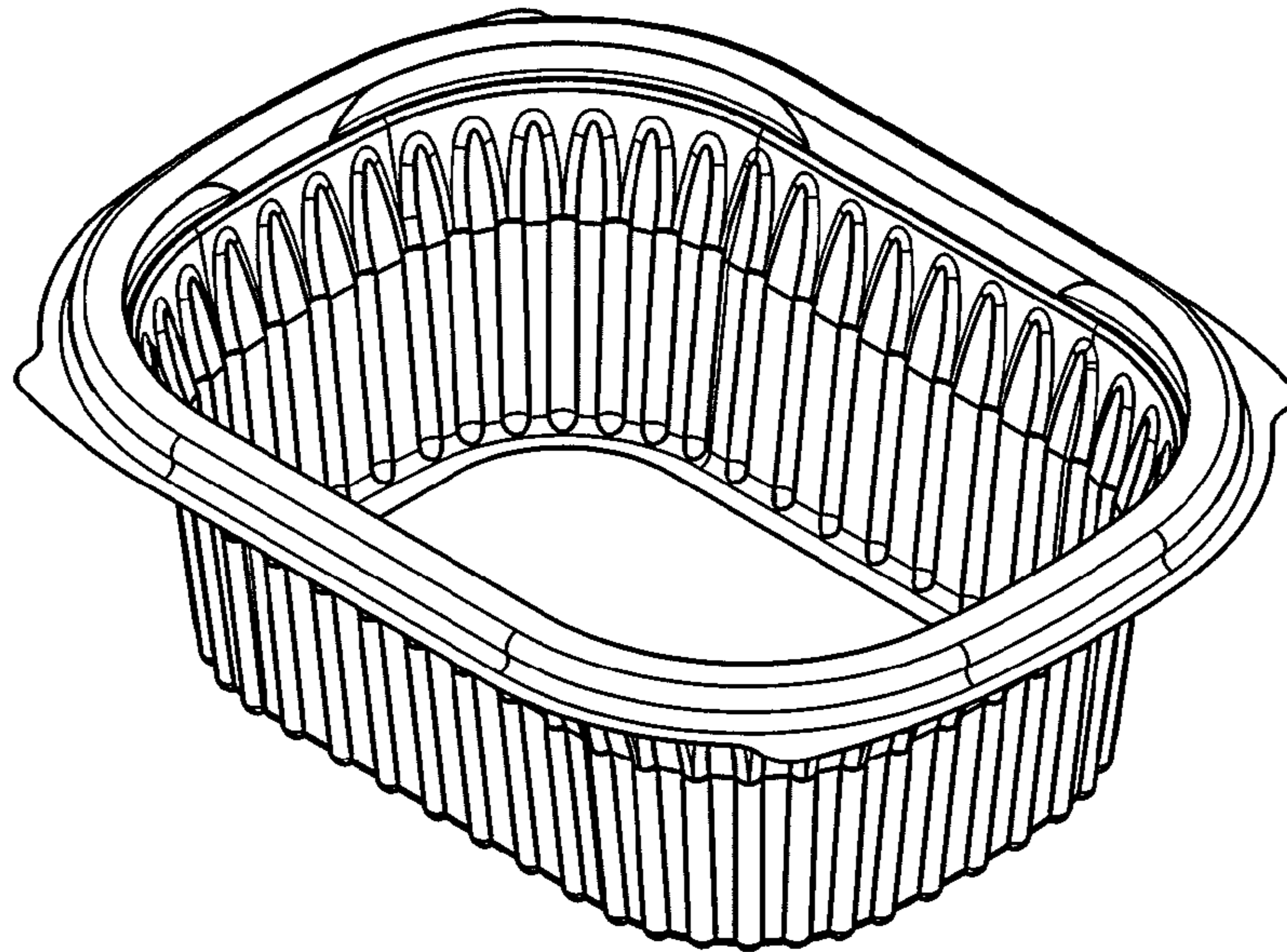

FIGURE #15

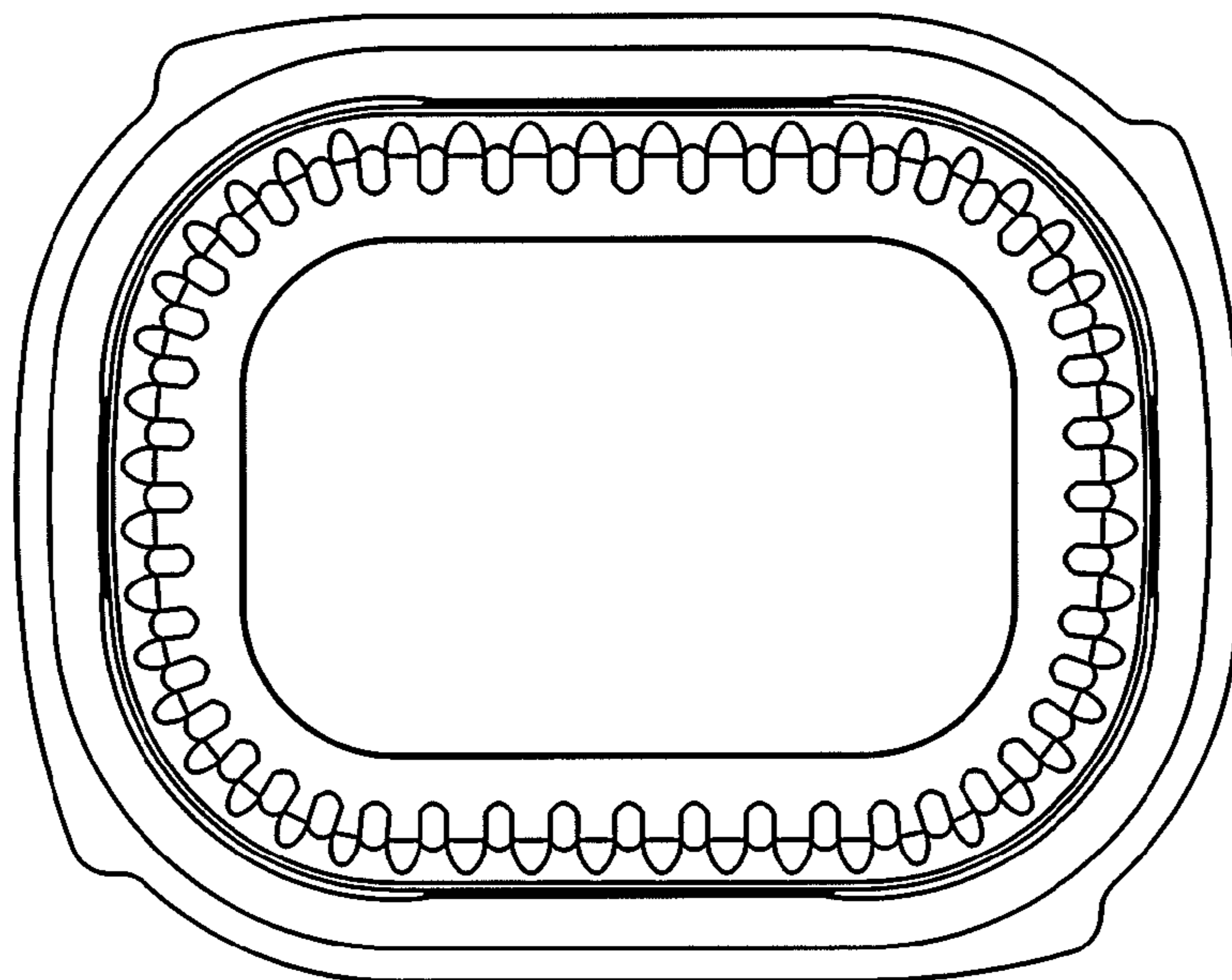

FIGURE #16

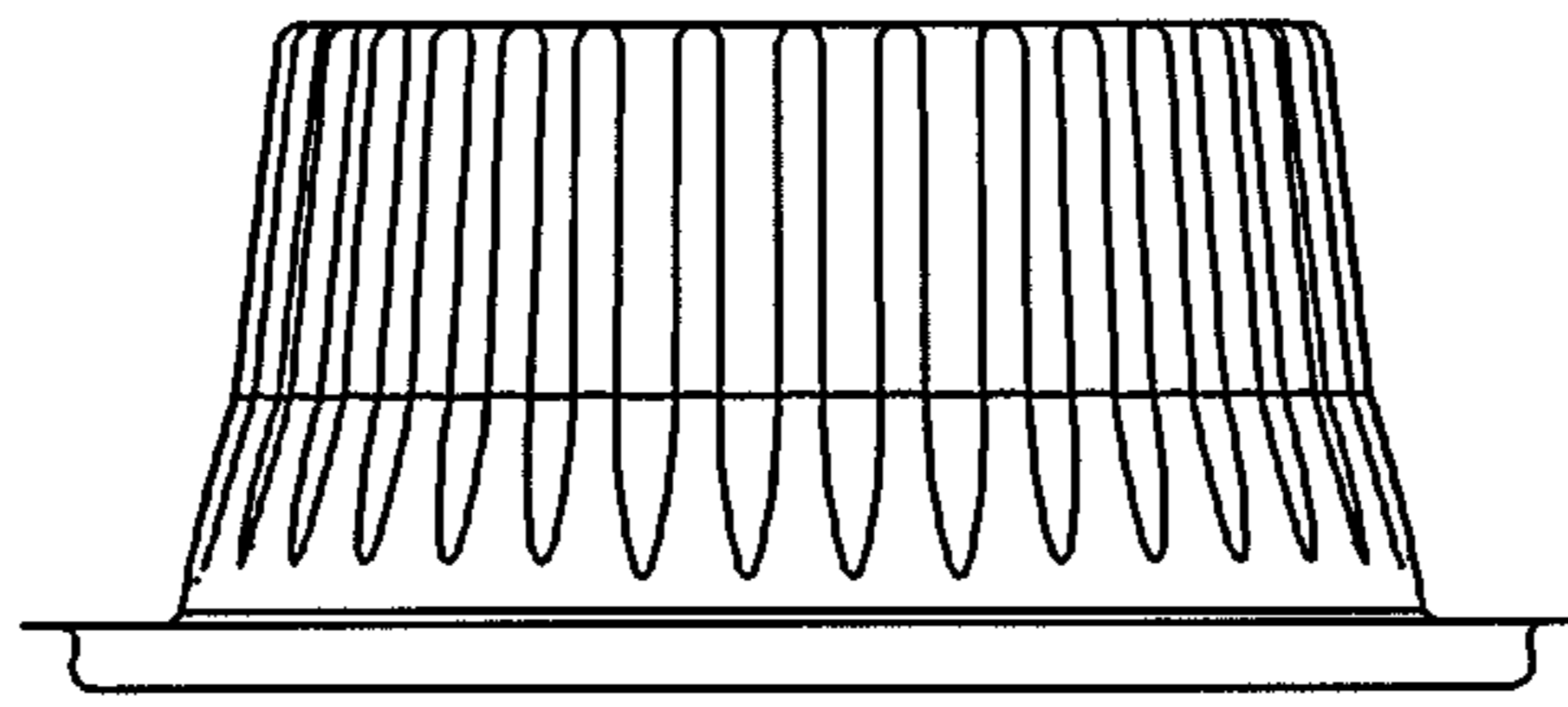

FIGURE #17

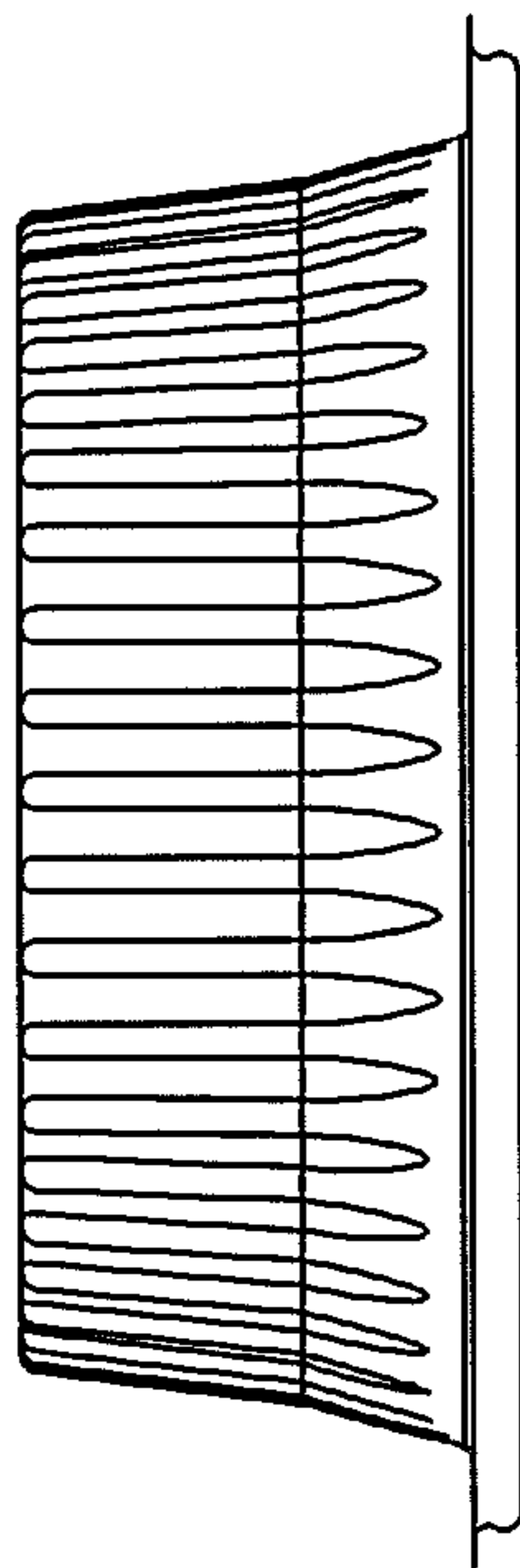

FIGURE #18

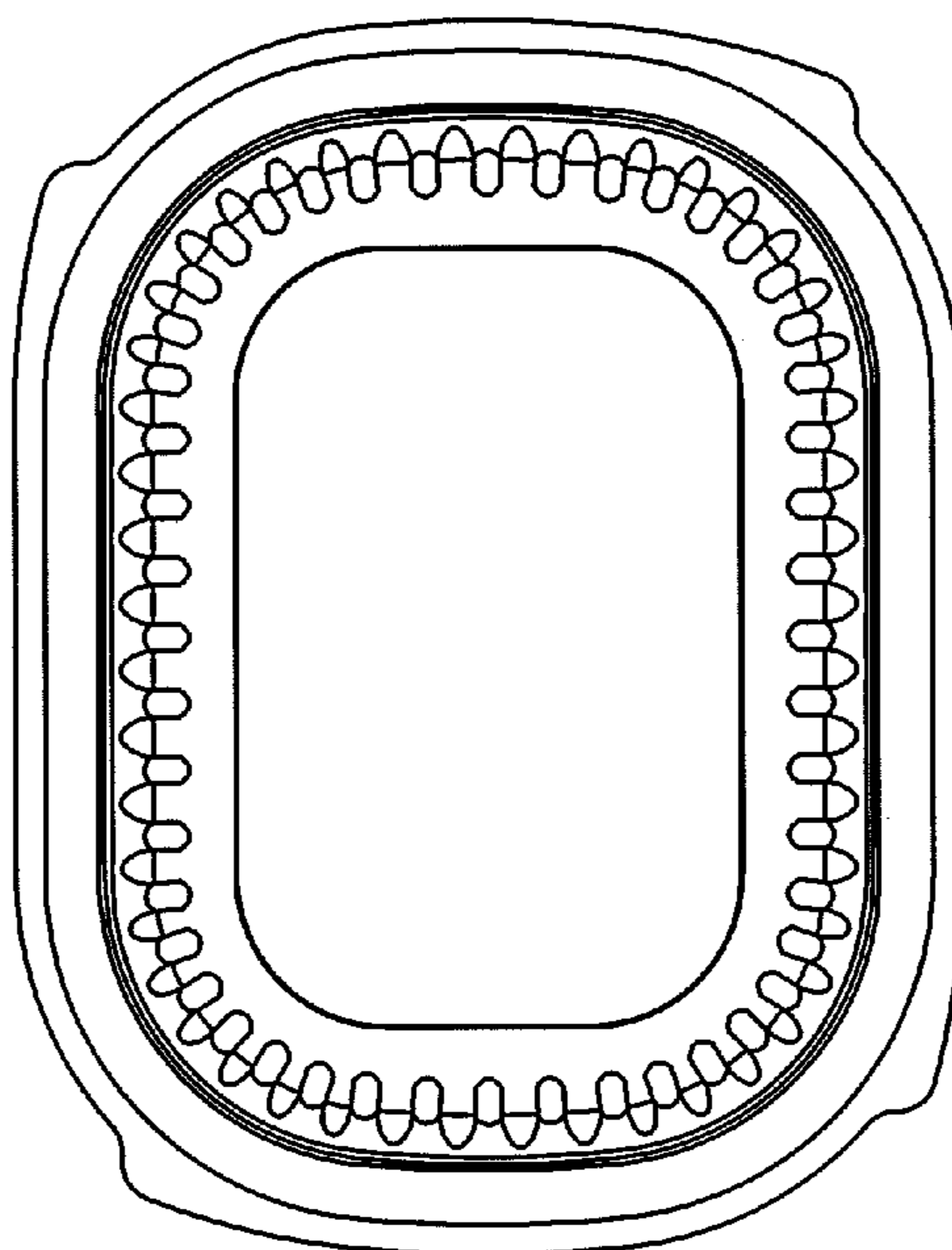

FIGURE #19

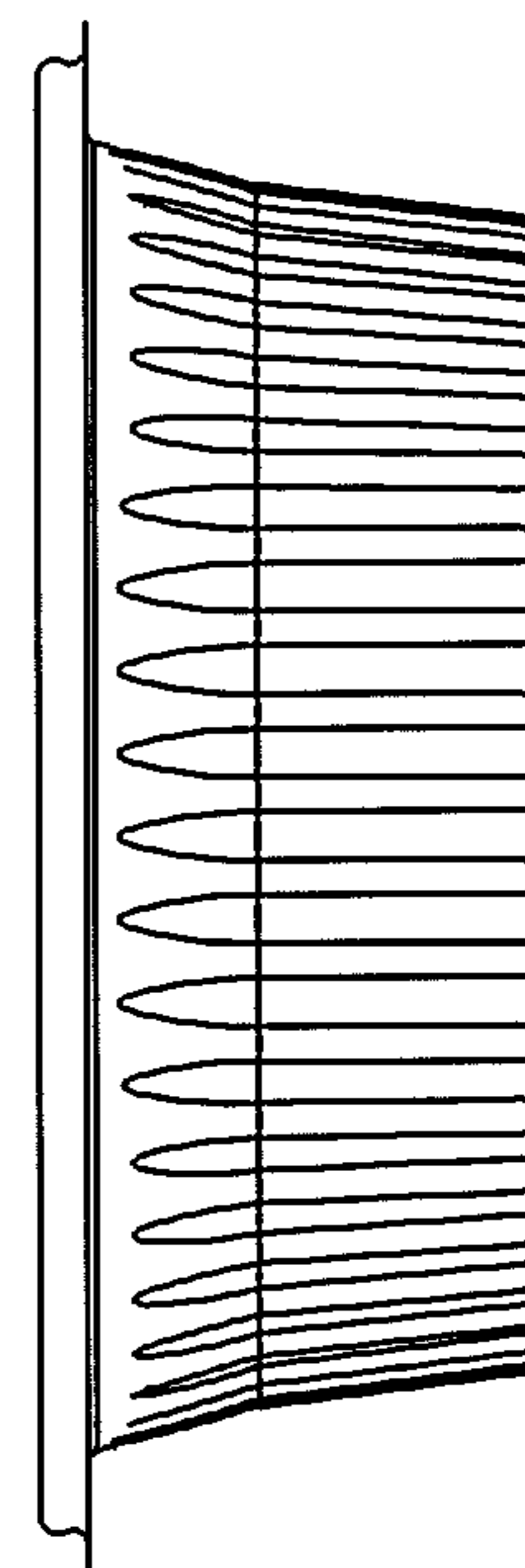

FIGURE #20

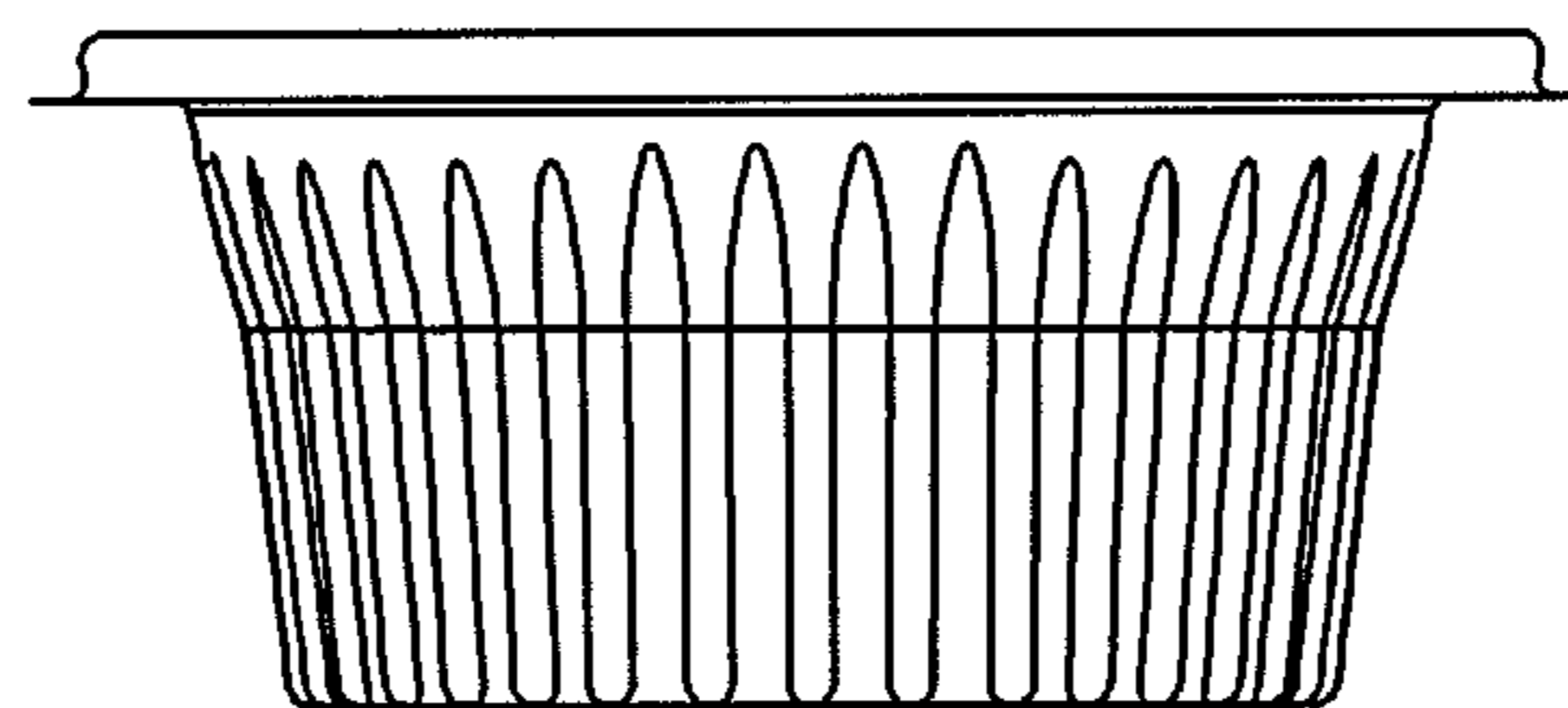

FIGURE #21



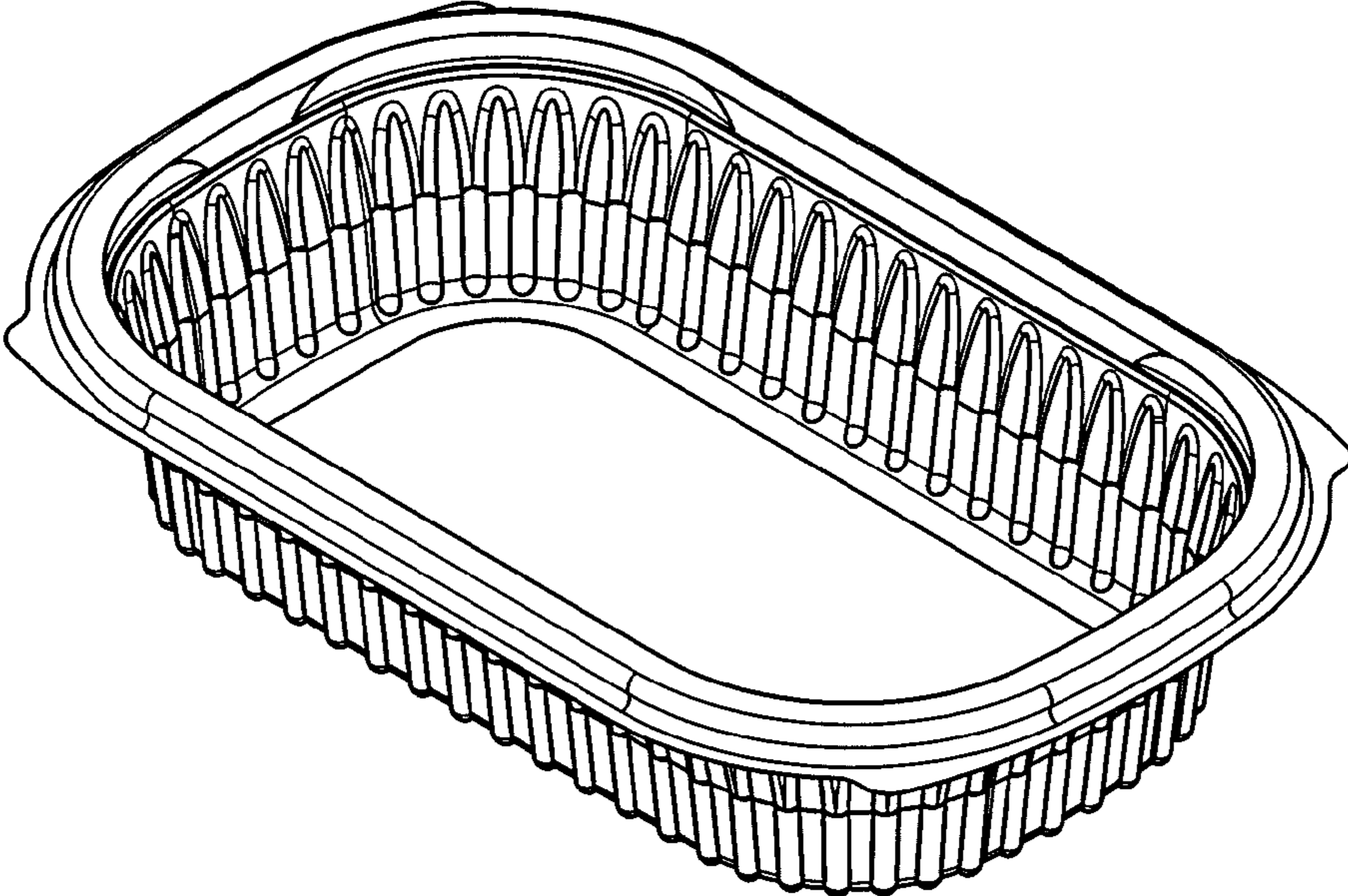

FIGURE #22

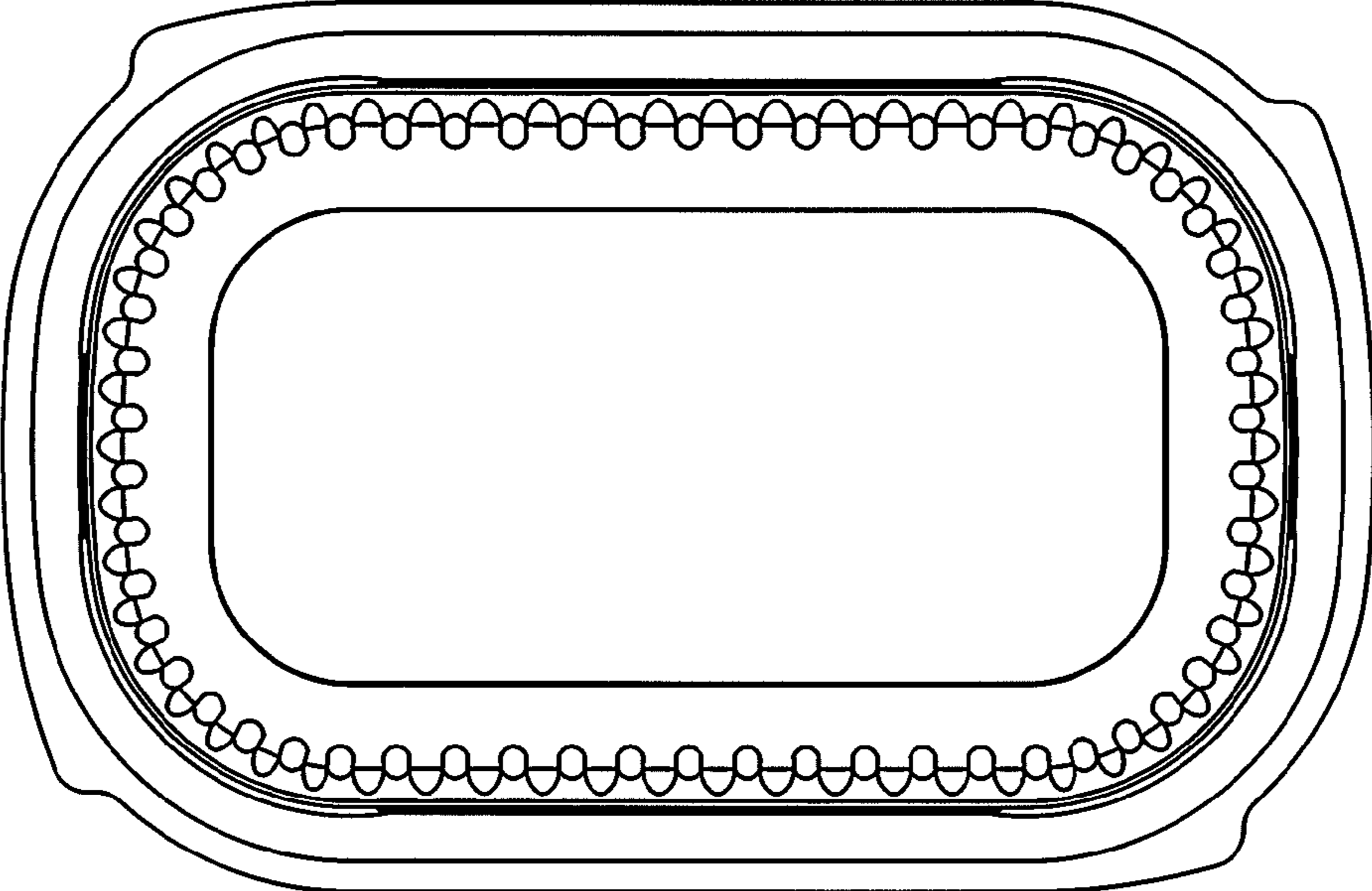

FIGURE #23

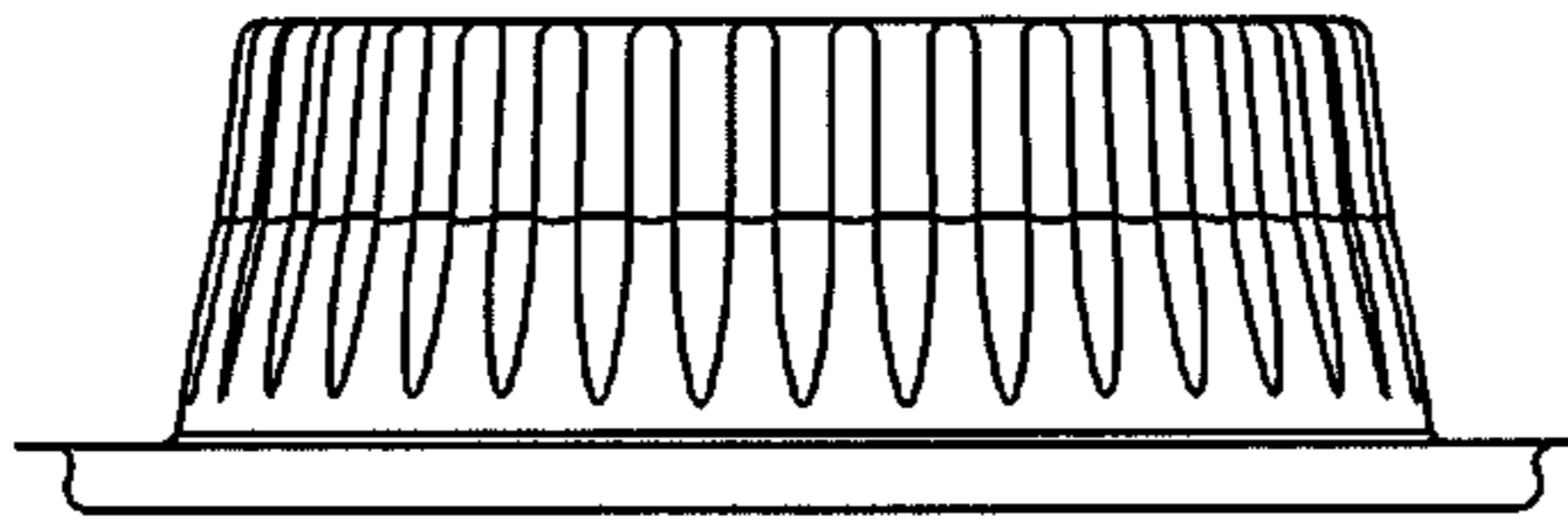

FIGURE #24

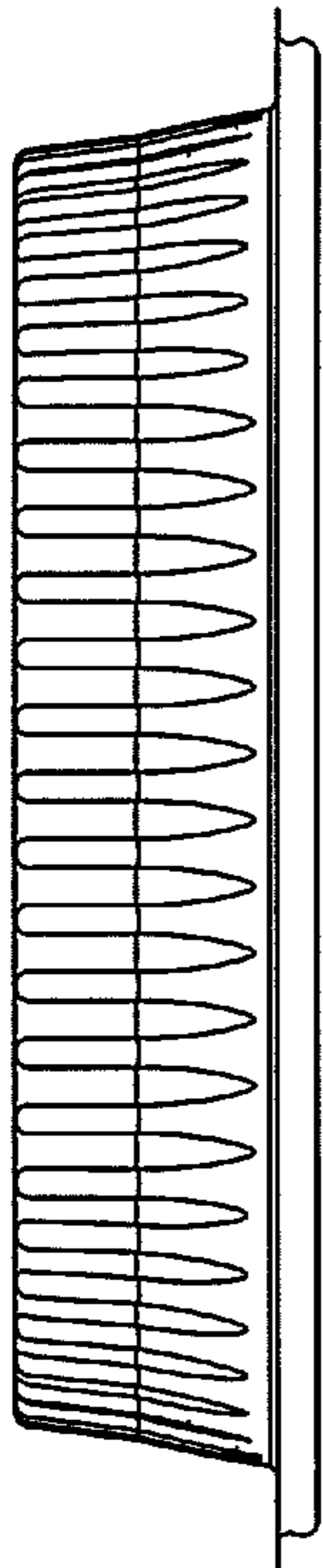

FIGURE #25

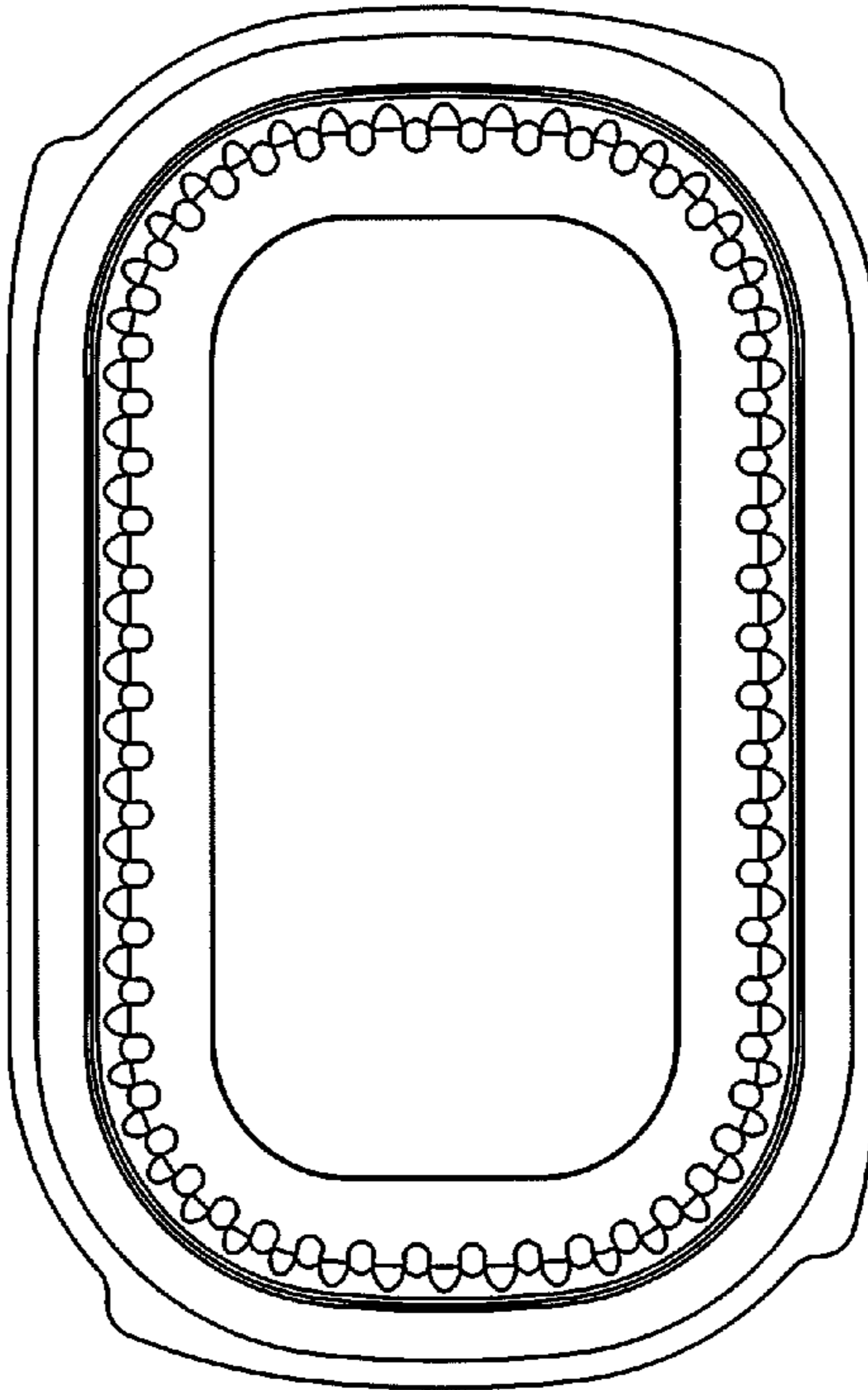

FIGURE #26

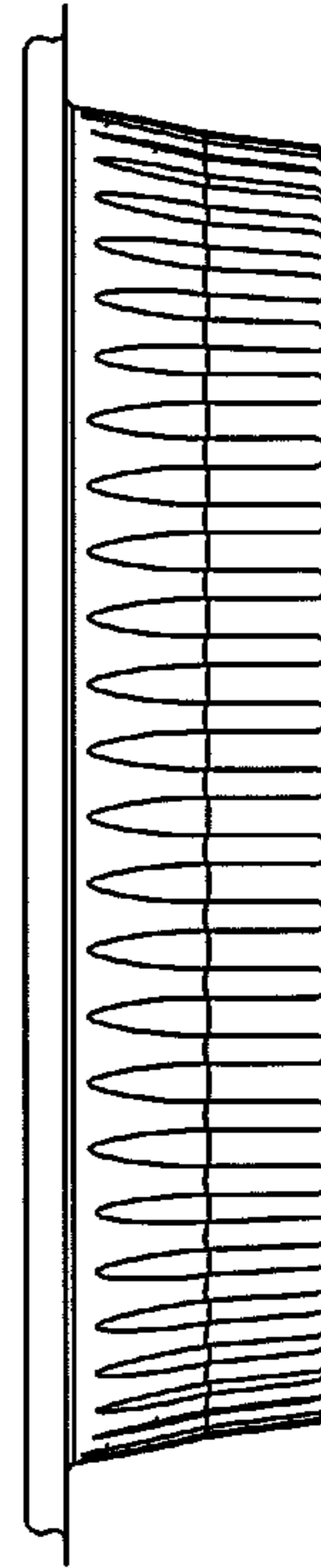

FIGURE #27

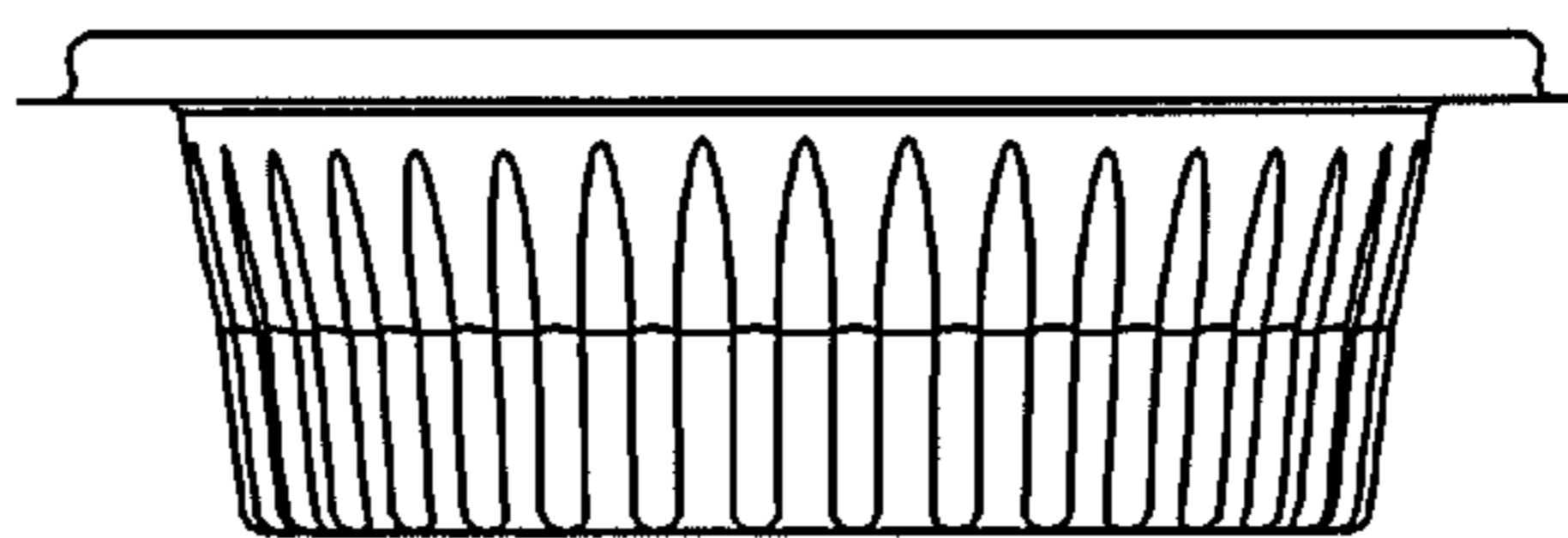

FIGURE #28

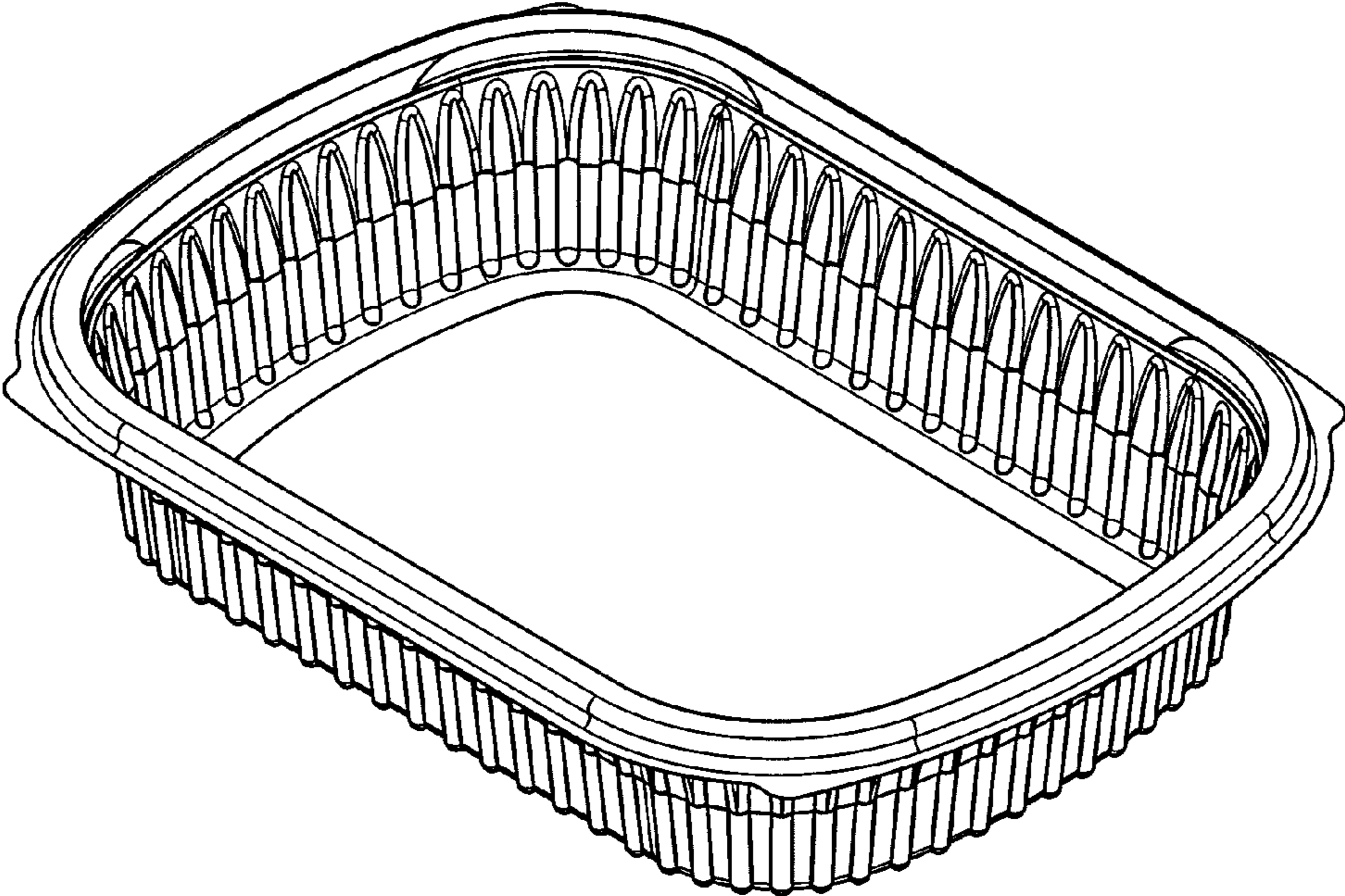

FIGURE #29

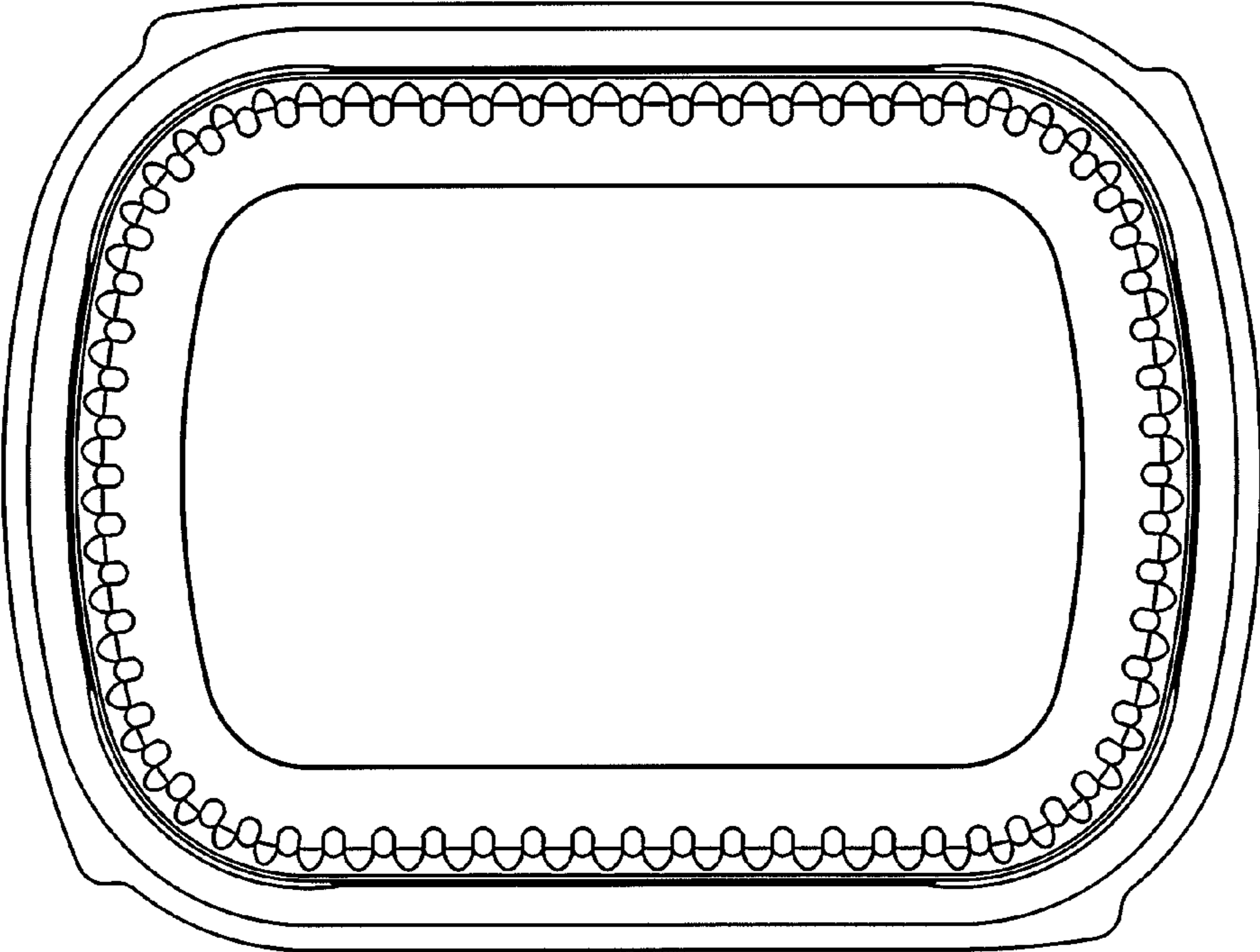

FIGURE #30

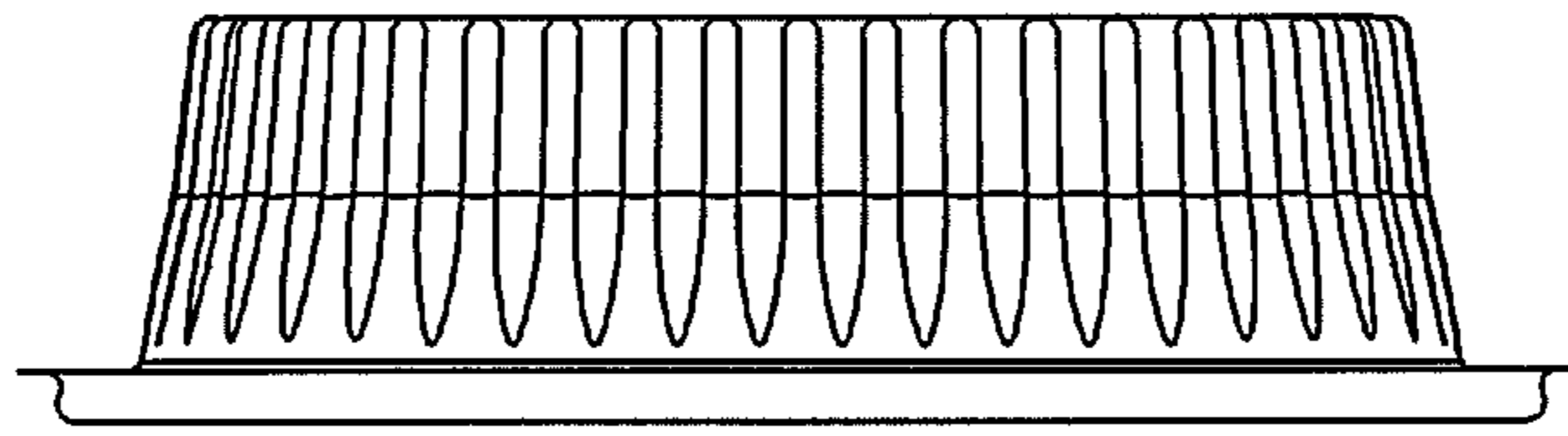

FIGURE #31

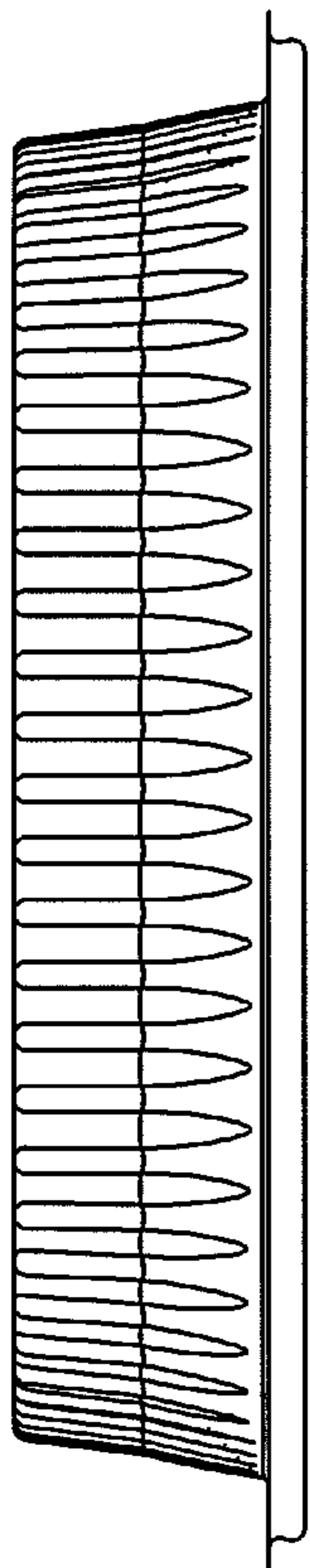

FIGURE #32

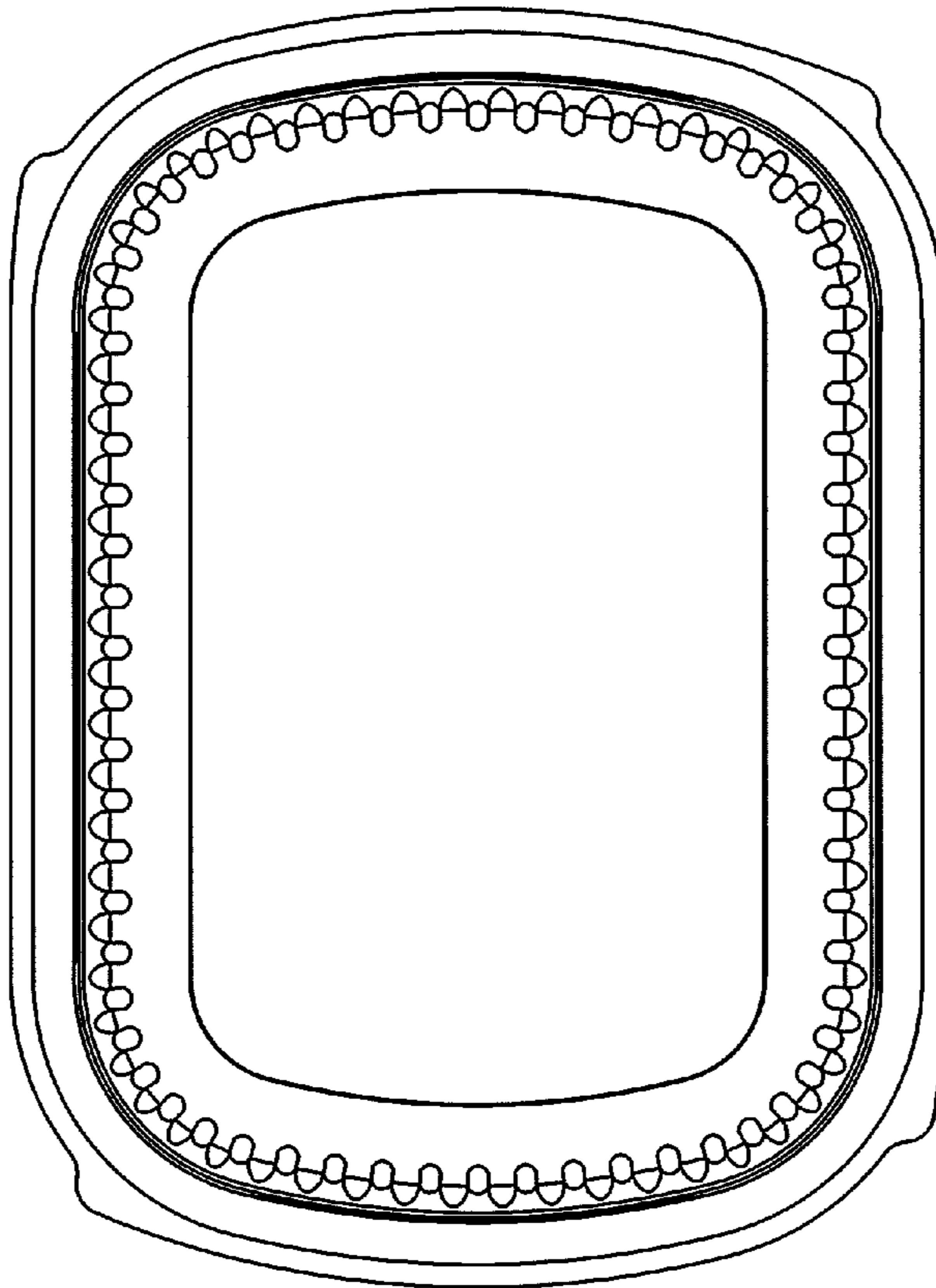

FIGURE #33

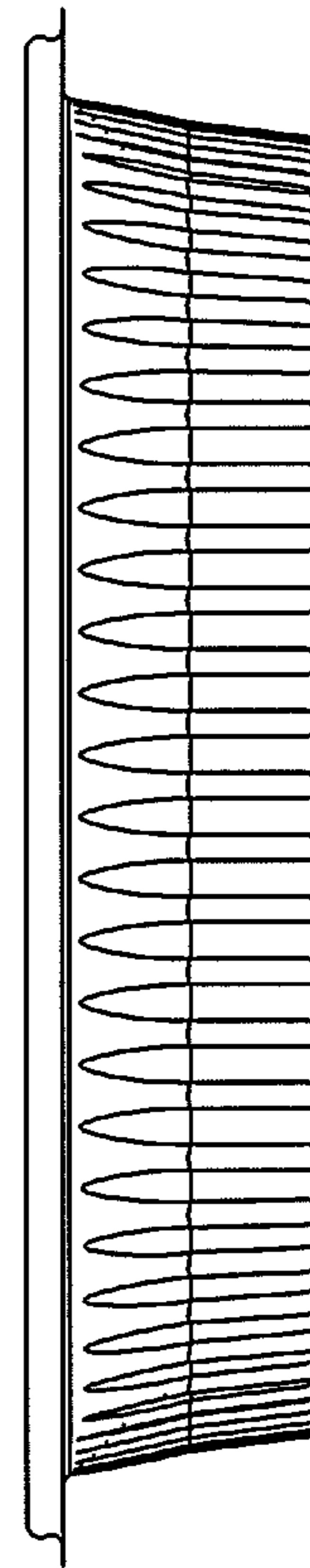

FIGURE #34

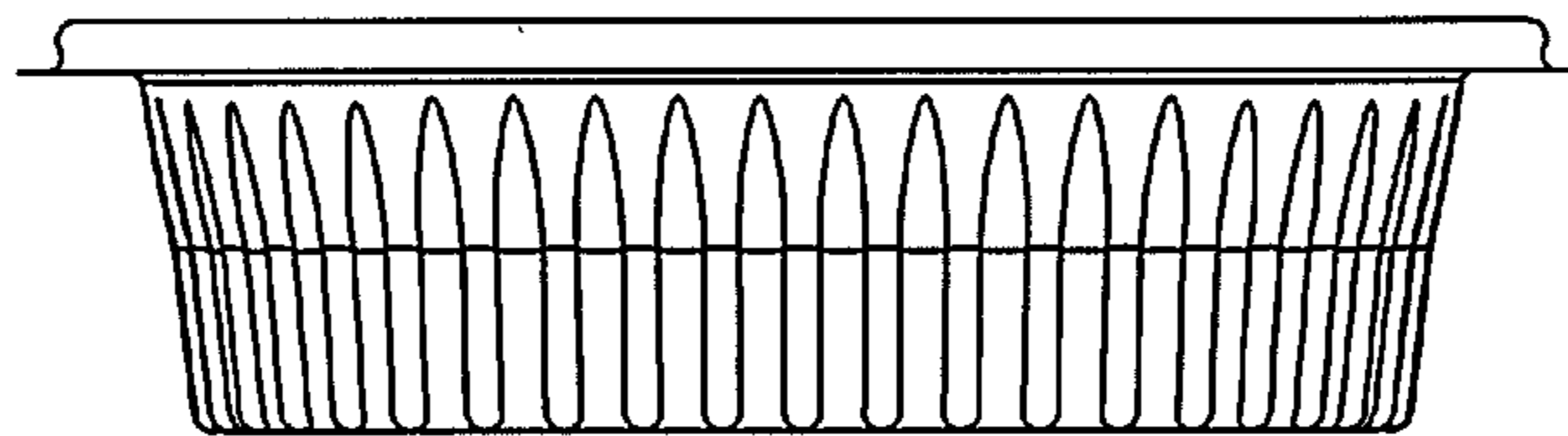

FIGURE #35

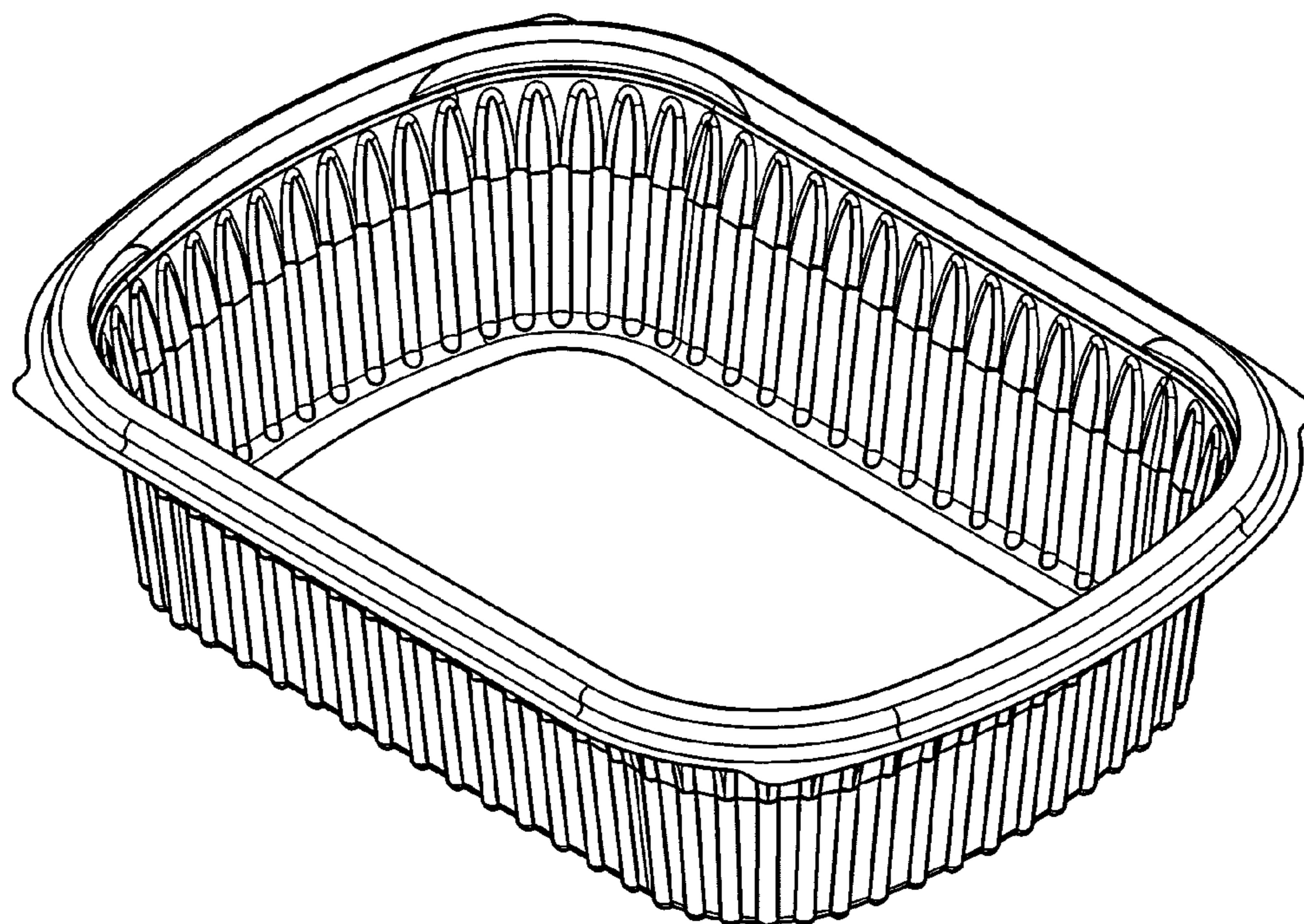

FIGURE #36

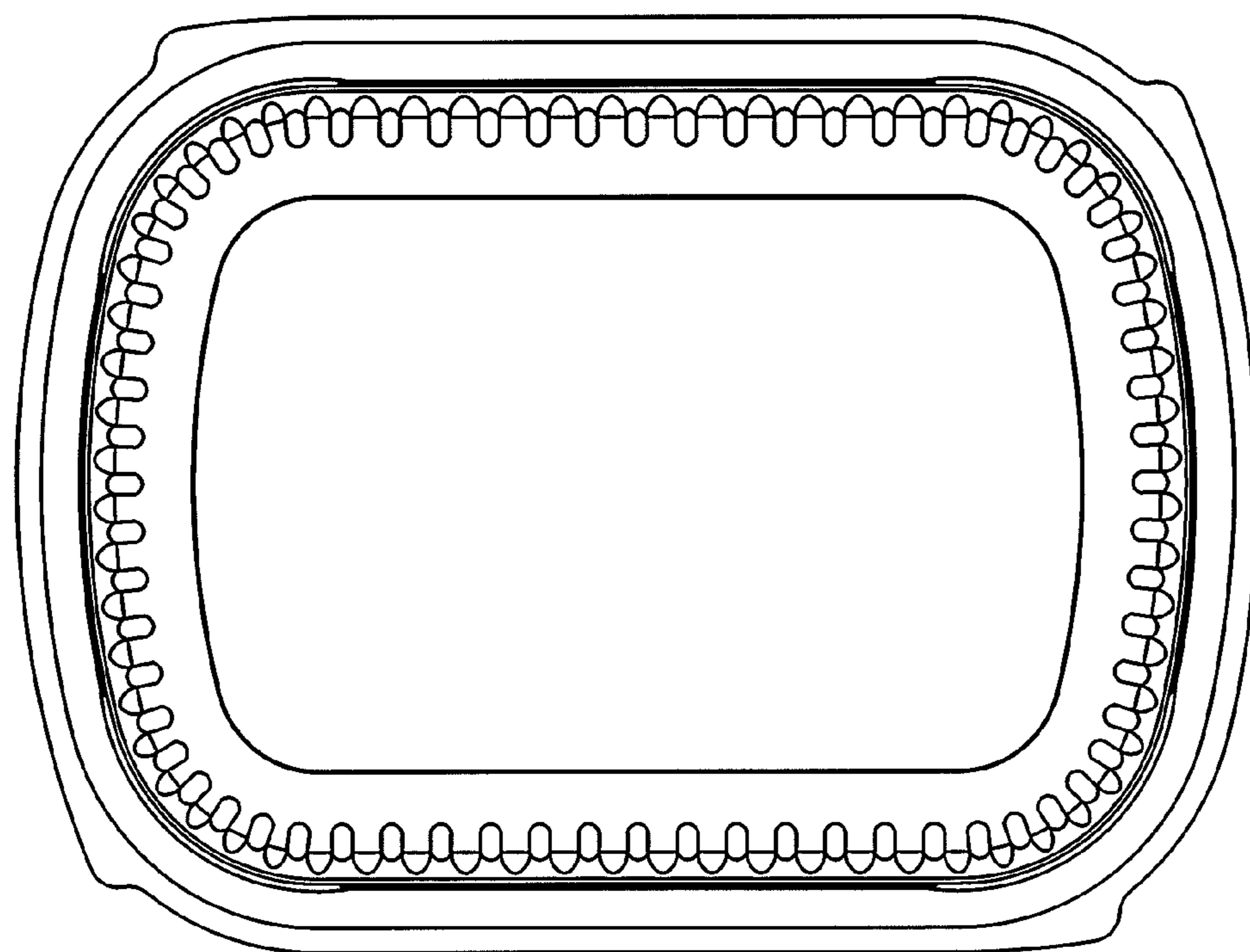

FIGURE #37

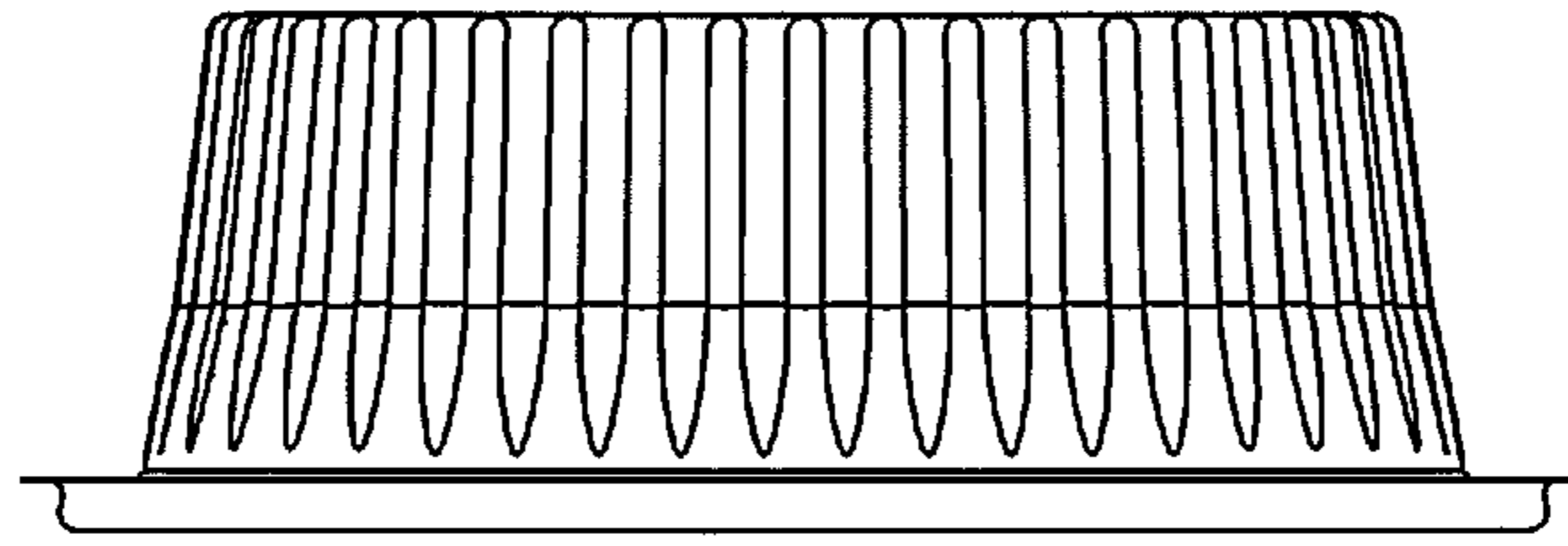

FIGURE #38

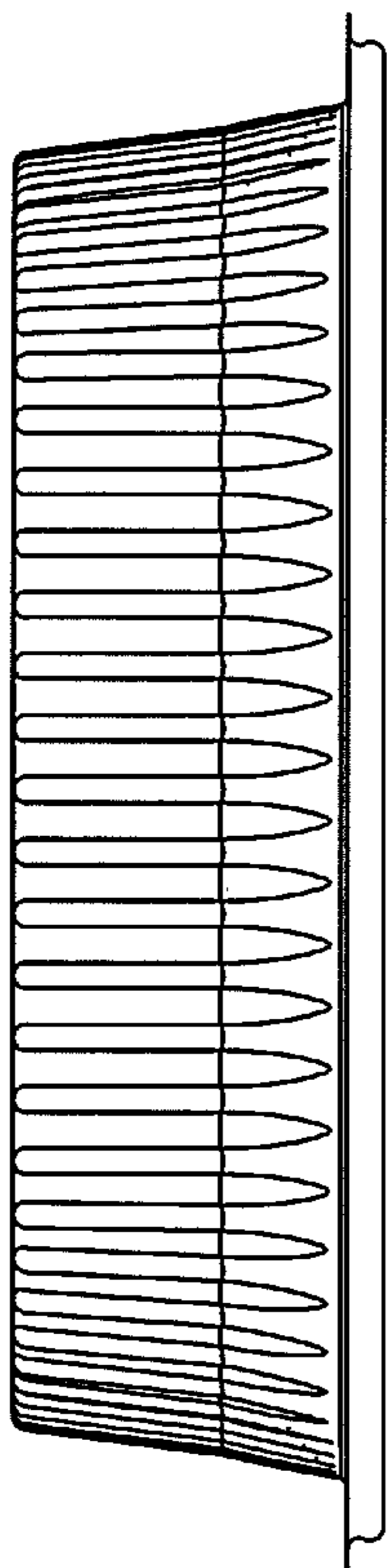

FIGURE #39

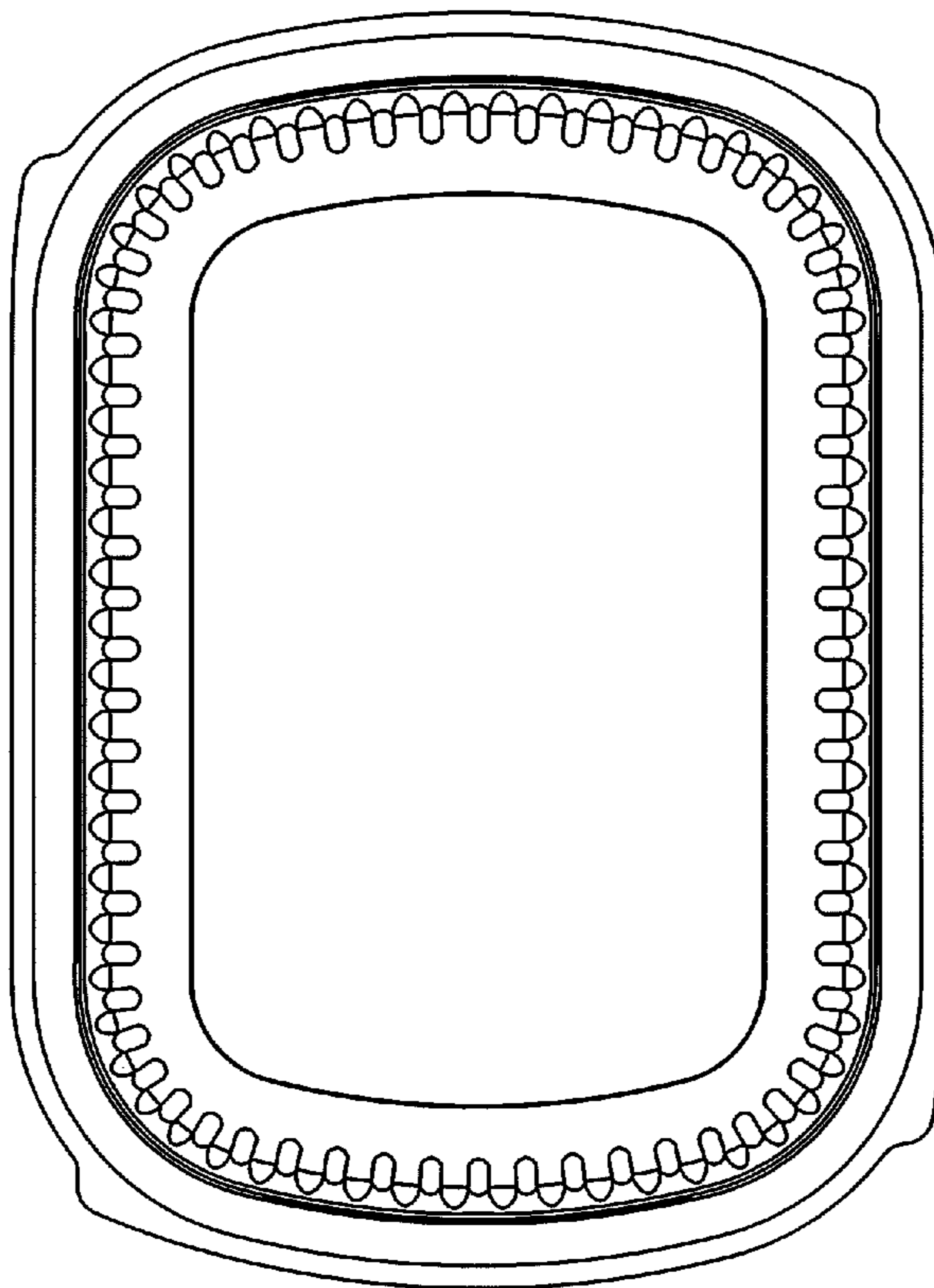

FIGURE #40

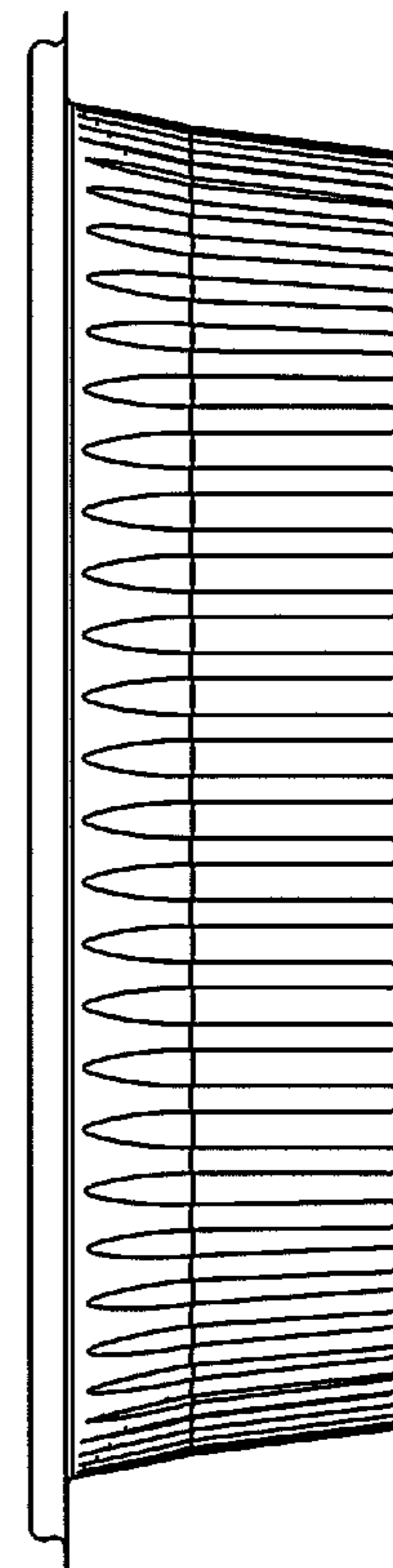

FIGURE #41

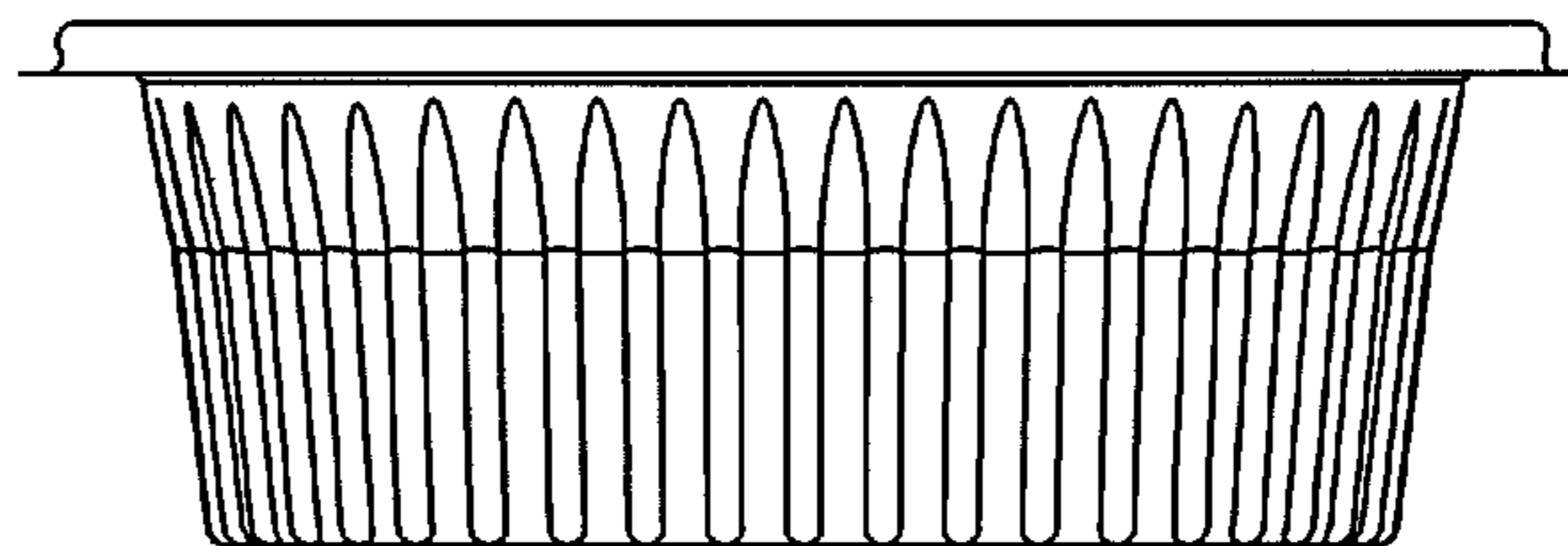

FIGURE #42