



US00D693885S

(12) **United States Design Patent**
Ouboter

(10) **Patent No.:** **US D693,885 S**

(45) **Date of Patent:** **** Nov. 19, 2013**

(54) **SCOOTER**

(75) Inventor: **Wim Ouboter**, Künsnacht-Zürich (CH)

(73) Assignee: **Micro Mobility Systems AG**,
Kuesnacht-Zurich (CH)

(**) Term: **14 Years**

(21) Appl. No.: **29/428,143**

(22) Filed: **Jul. 26, 2012**

(30) **Foreign Application Priority Data**

Jan. 30, 2012 (EP) 001312052-0001

(51) **LOC (9) Cl.** **21-01**

(52) **U.S. Cl.**
USPC **D21/423**

(58) **Field of Classification Search**

USPC D21/419, 421, 423, 426, 769, 760, 765,
D21/771, 803; D12/1, 8; 280/14.21, 14.25,
280/14.26, 87.041, 87.042, 263, 288.1,
280/288.2, 288.4, 200, 214, 809; 180/180,
180/181

See application file for complete search history.

(56) **References Cited**

U.S. PATENT DOCUMENTS

D452,886	S	*	1/2002	Wang et al.	D21/423
D475,093	S	*	5/2003	Furter et al.	D21/423
D564,037	S	*	3/2008	Cramer et al.	D21/423
D648,402	S	*	11/2011	Wang	D21/423
D654,964	S	*	2/2012	Herlitz et al.	D21/423
D654,965	S	*	2/2012	Herlitz et al.	D21/423
2012/0098238	A1	*	4/2012	Wang et al.	280/655.1
2012/0181773	A1	*	7/2012	Ouboter	280/263

* cited by examiner

Primary Examiner — Cynthia M Chin

(74) *Attorney, Agent, or Firm* — Posz Law Group, PLC

(57) **CLAIM**

The ornamental design for a scooter, as shown and described.

DESCRIPTION

FIG. 1 is a perspective view of top, front, and right side of a scooter showing my new design;
FIG. 2 is a perspective view of top, rear, and right side thereof;
FIG. 3 is a front view thereof;
FIG. 4 is a rear view thereof;
FIG. 5 is a left side view thereof, the right side view being a mirror image;
FIG. 6 is a bottom view thereof; and,
FIG. 7 is a top plan view thereof.
Portions of the article shown in broken lines form no part of the claimed design.

1 Claim, 7 Drawing Sheets

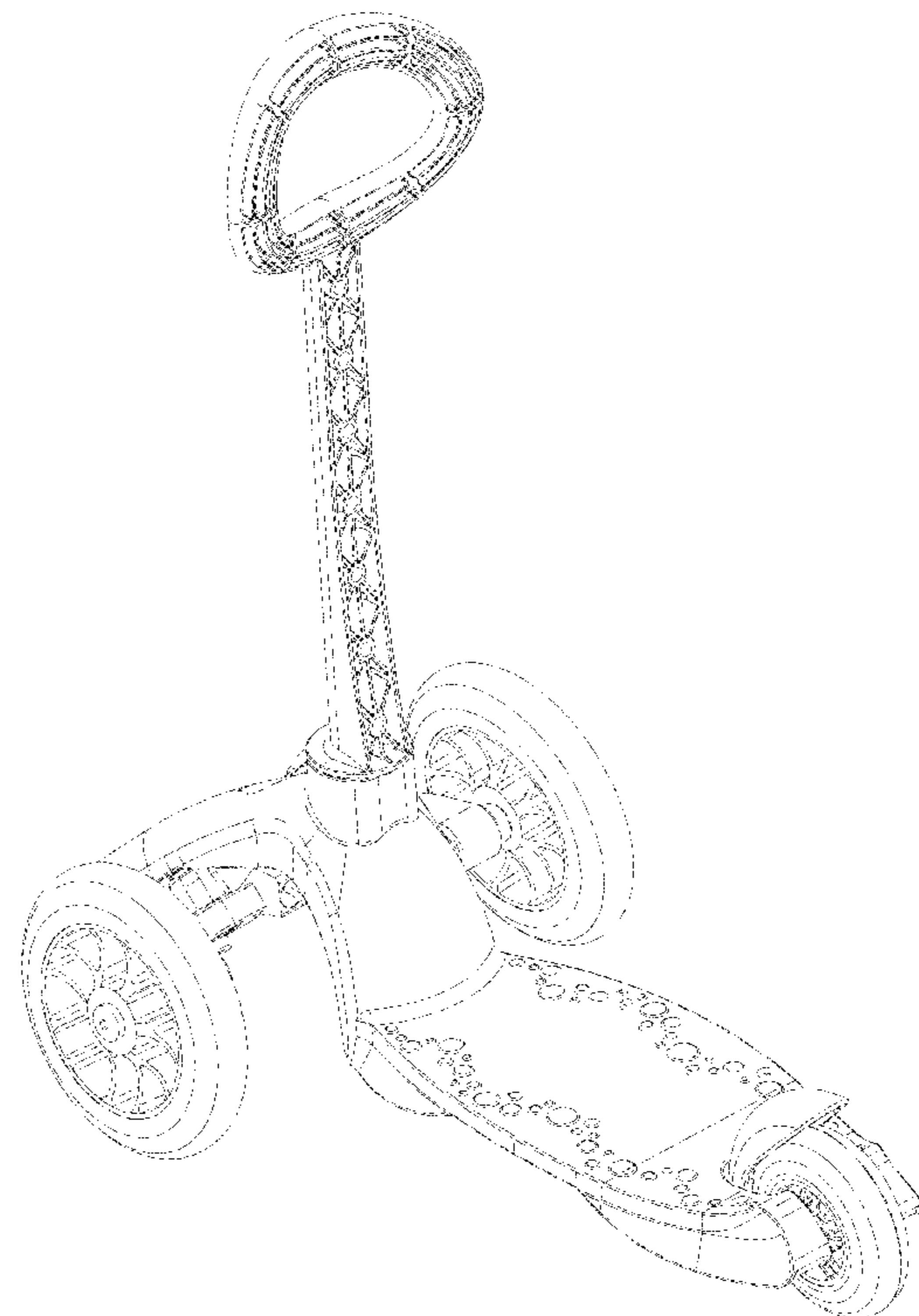
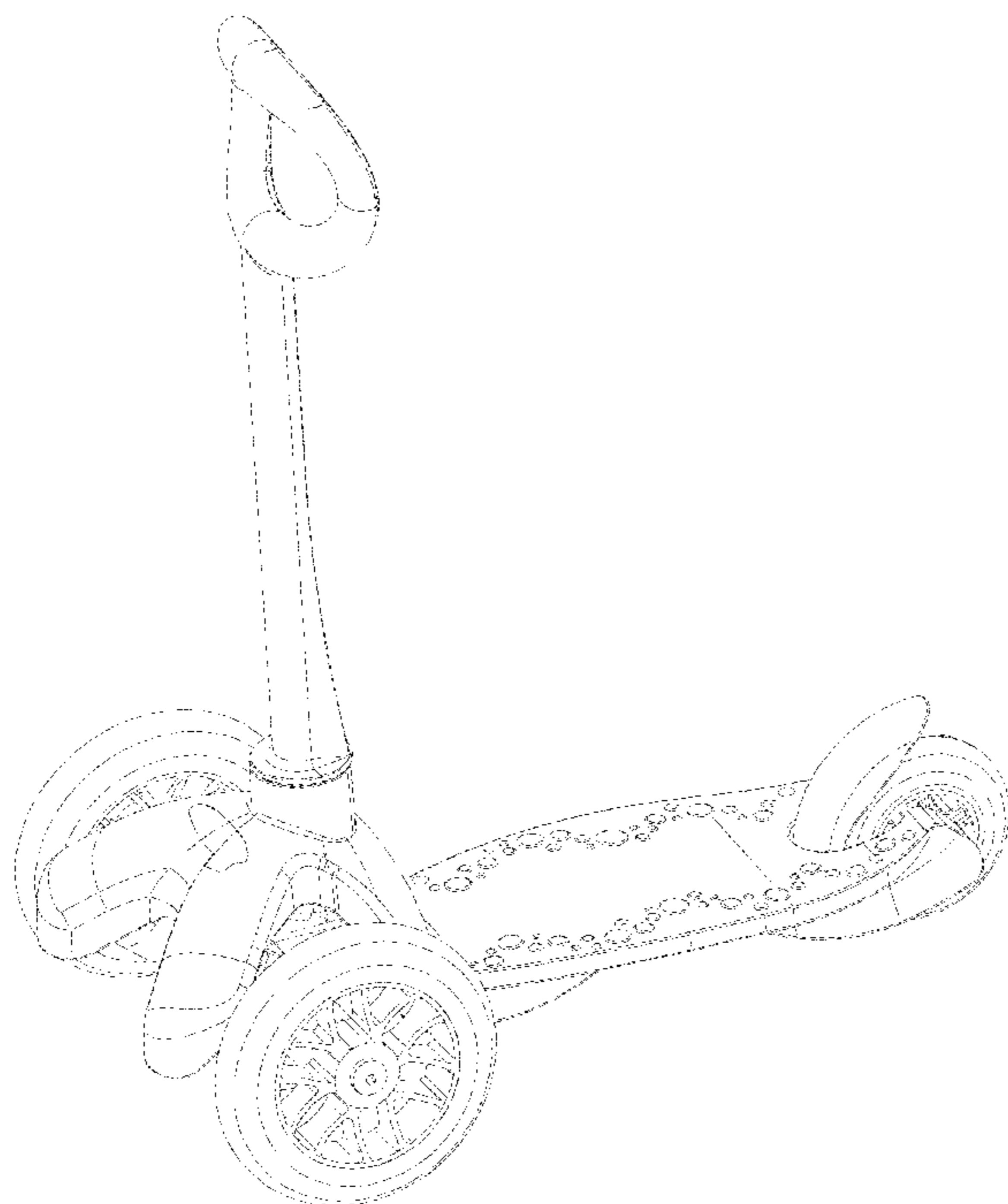

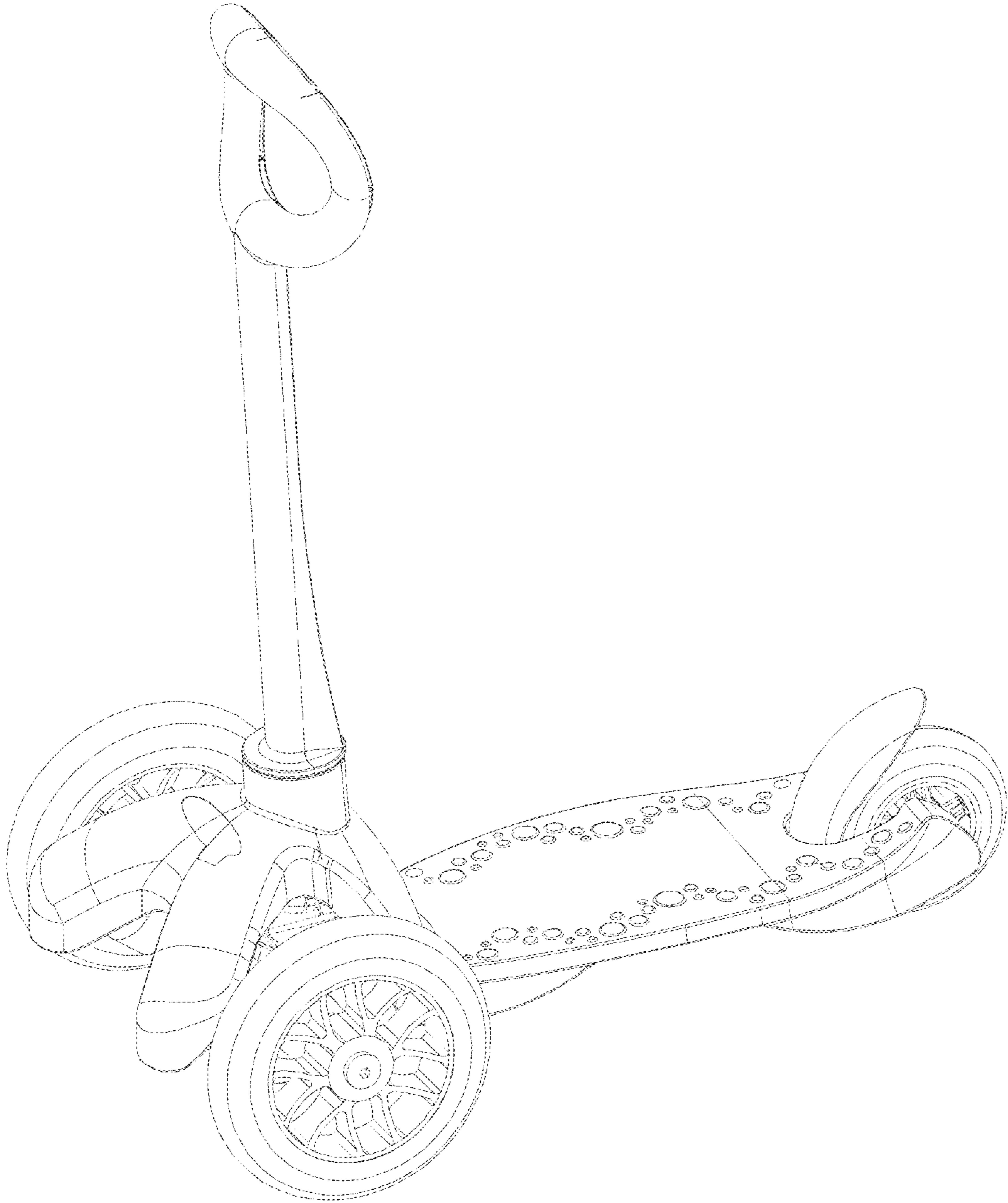

Fig. 1

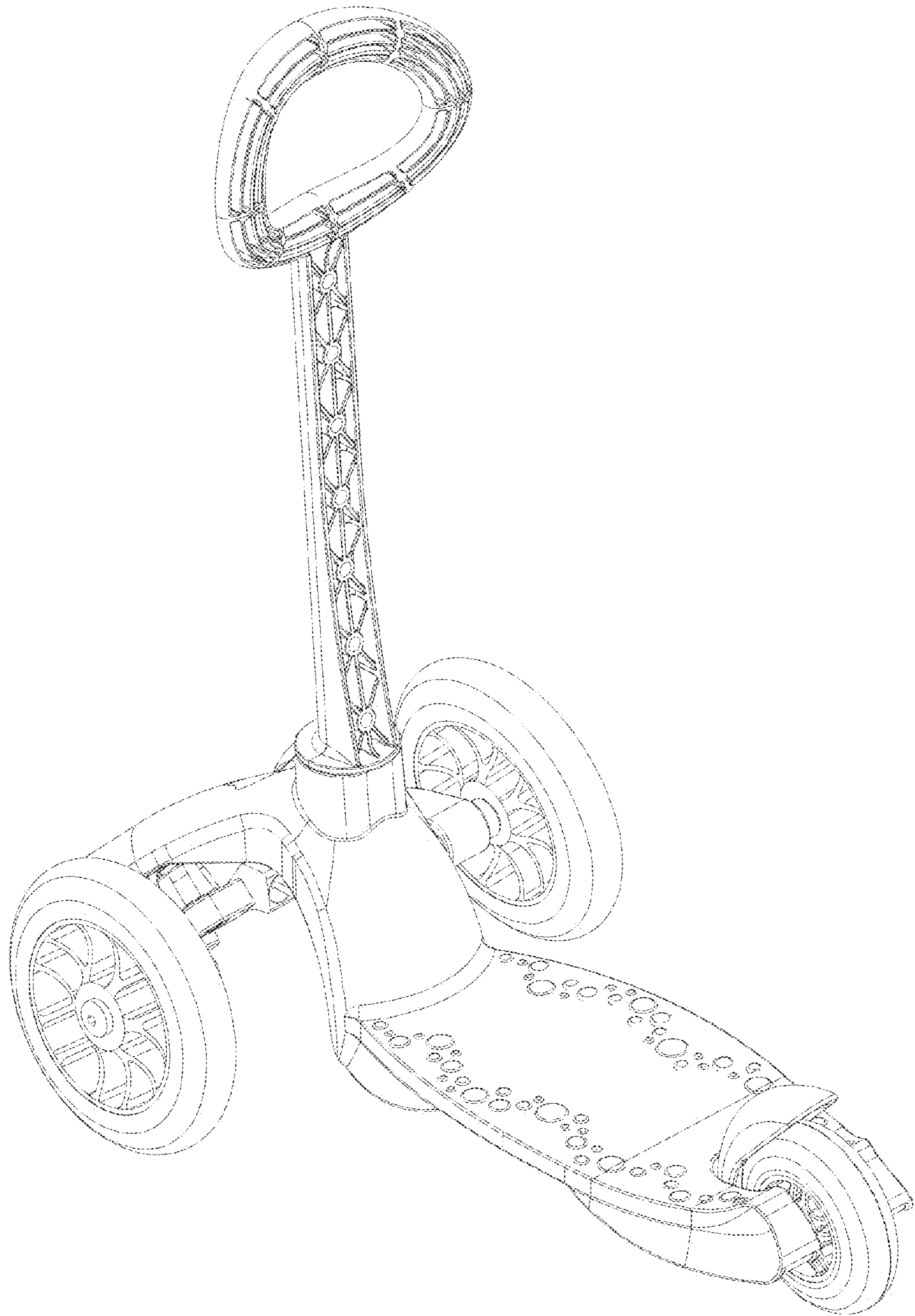

Fig. 2

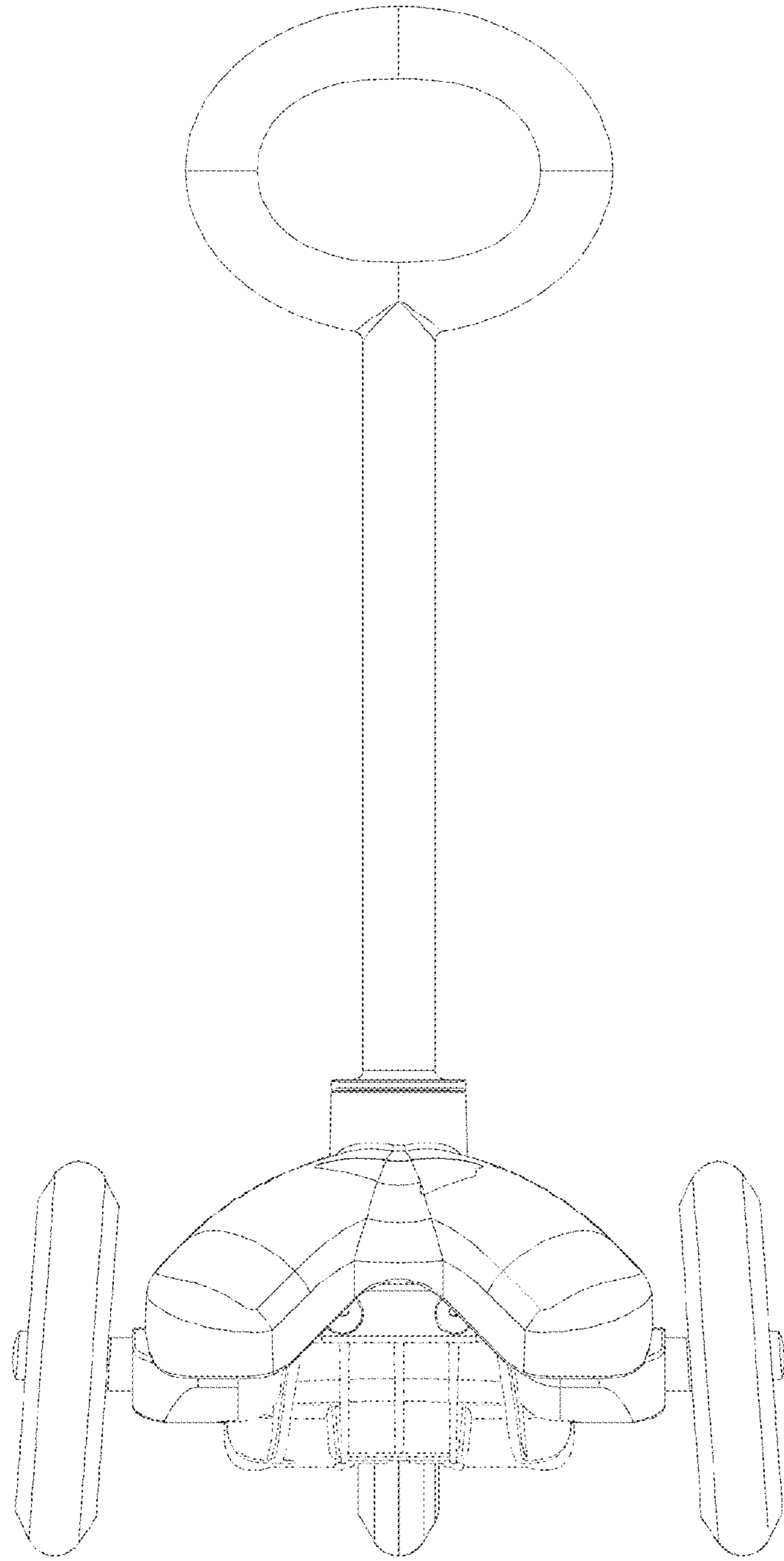

Fig. 3

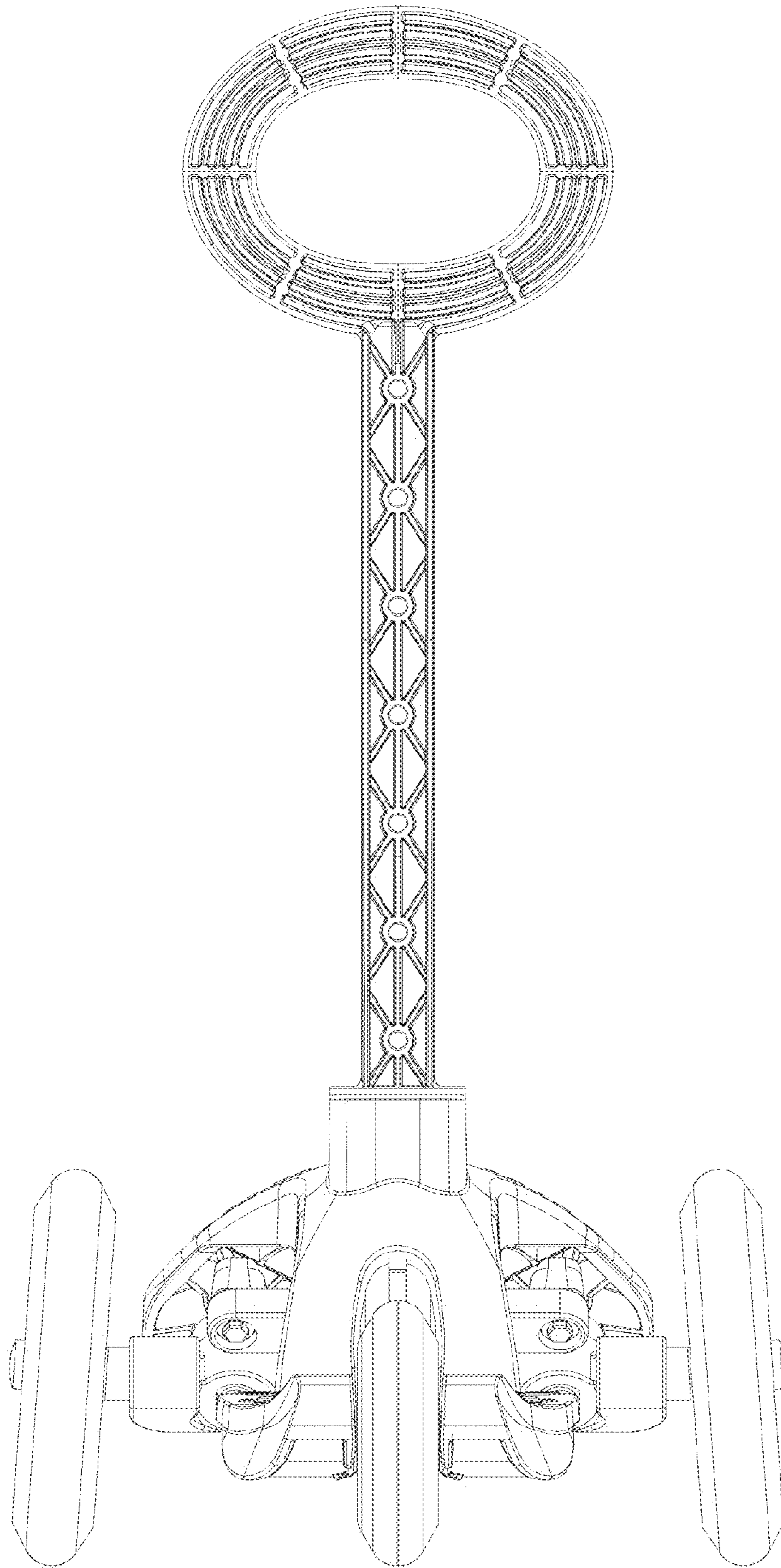

Fig. 4

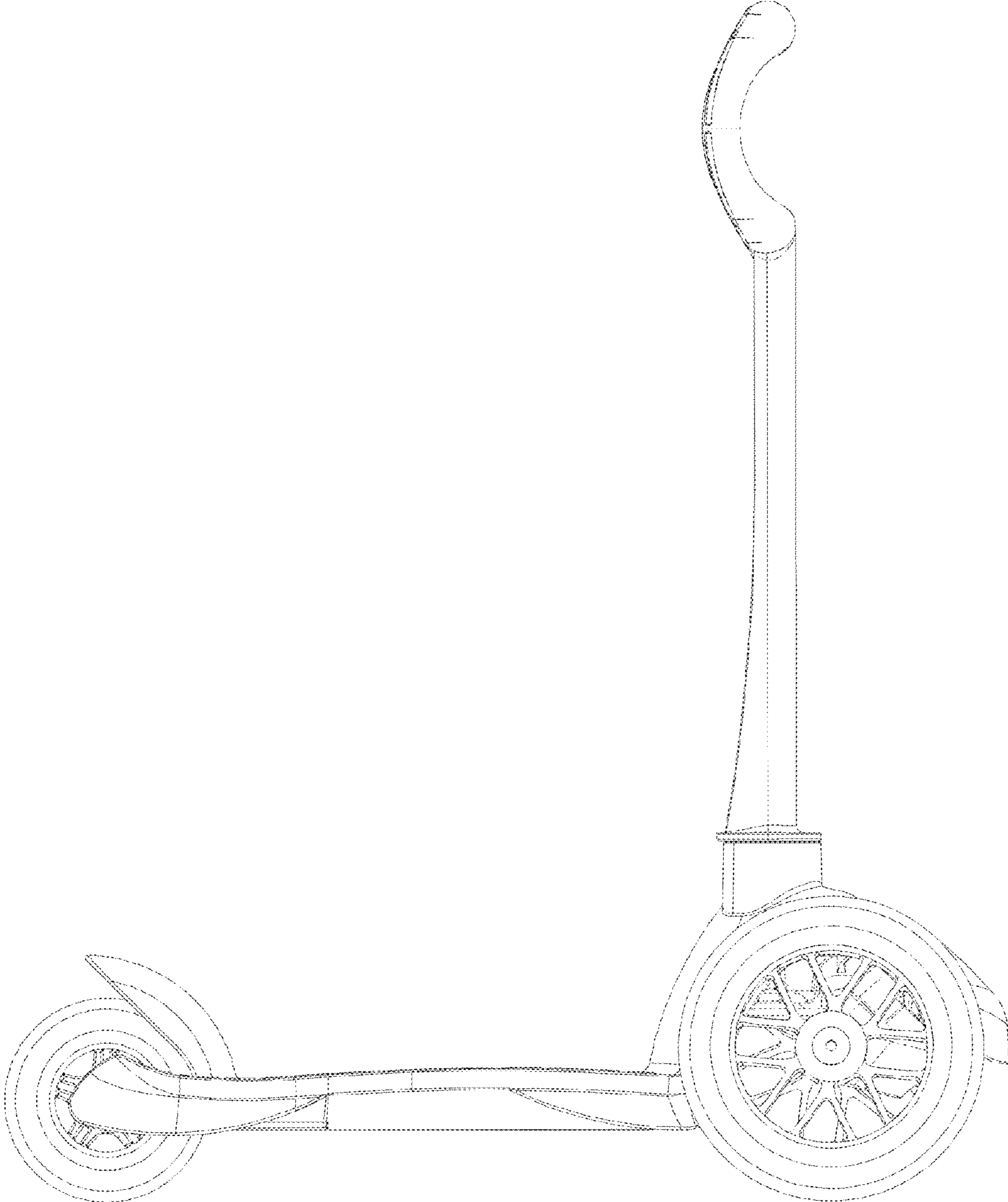

Fig. 5

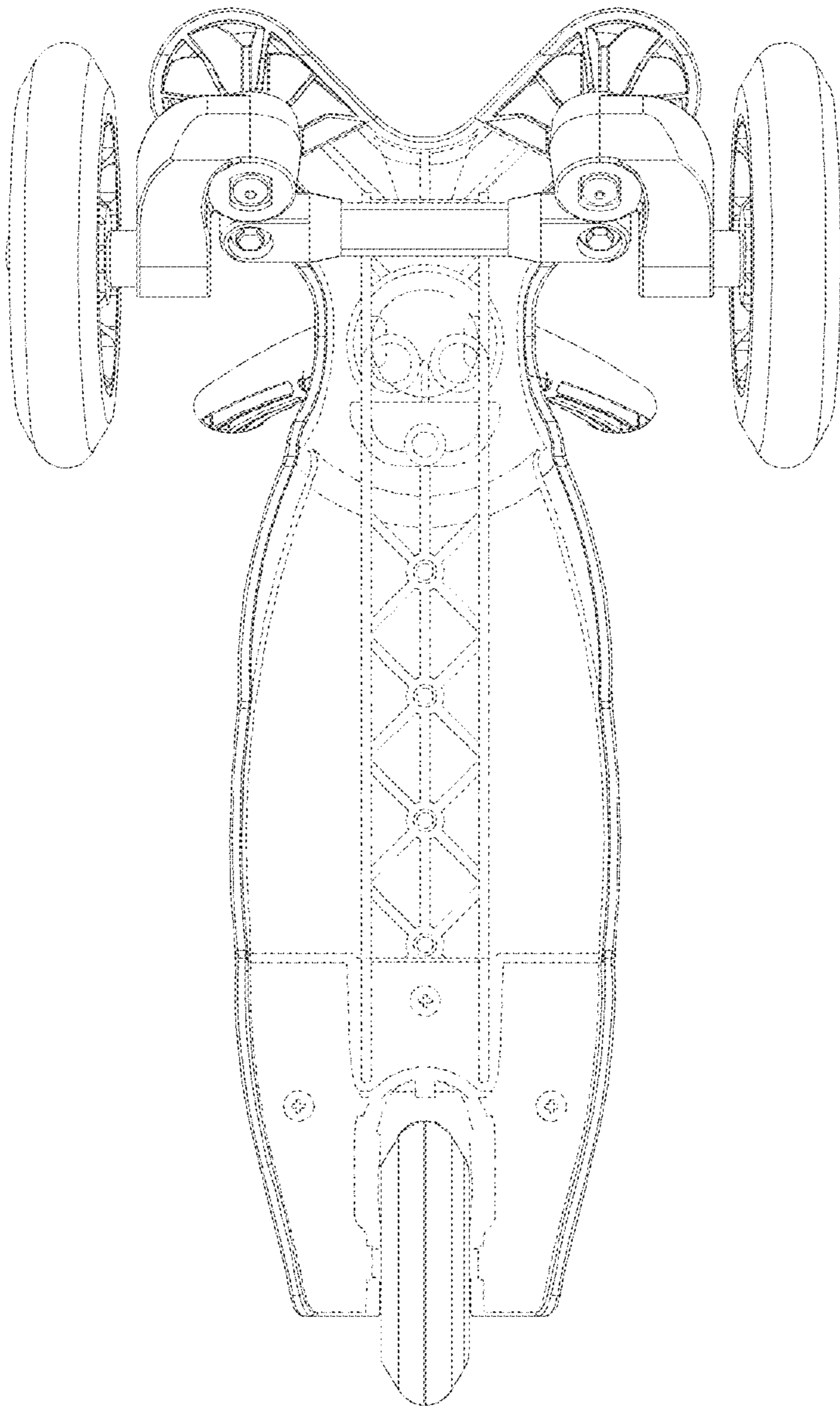

Fig. 6

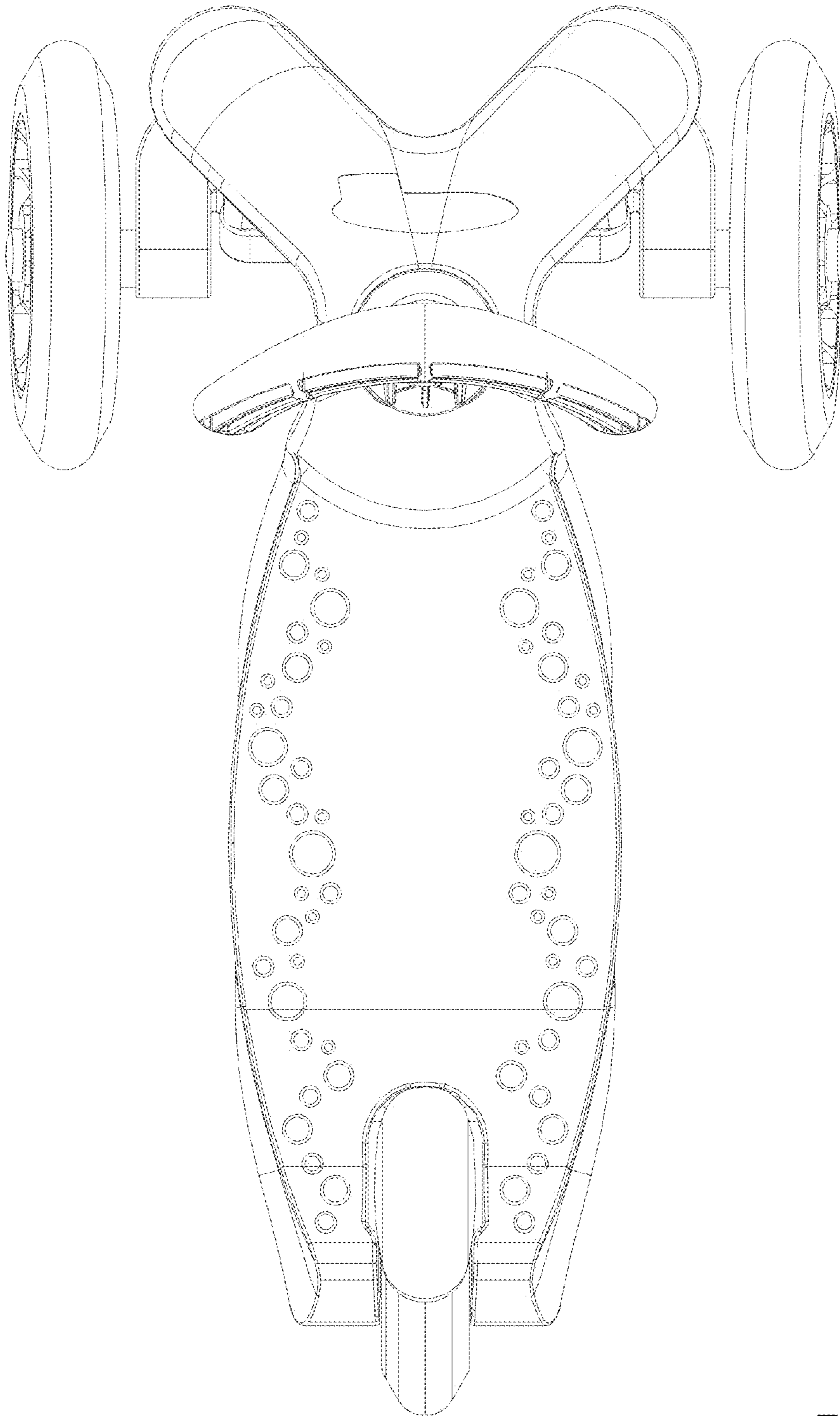

Fig. 7