



US00D693876S

(12) **United States Design Patent**  
**Jiang**

(10) **Patent No.:** **US D693,876 S**

(45) **Date of Patent:** **\*\* Nov. 19, 2013**

(54) **PEN**

(75) Inventor: **Linghua Jiang**, Ningbo (CN)

(73) Assignee: **Beifa Group Co., Ltd.**, Ningbo (CN)

(\*\*) Term: **14 Years**

(21) Appl. No.: **29/423,979**

(22) Filed: **Jun. 6, 2012**

(30) **Foreign Application Priority Data**

Dec. 6, 2011 (CN) ..... 2011 3 0460061

(51) **LOC (9) Cl.** ..... **19-06**

(52) **U.S. Cl.**  
USPC ..... **D19/43**

(58) **Field of Classification Search**  
USPC ..... D14/411; D19/35, 36, 41-51, 53-58;  
24/11 F, 11 P, 11 R; 401/52, 99-109,  
401/192, 195, 196

See application file for complete search history.

(56) **References Cited**

**U.S. PATENT DOCUMENTS**

D206,735 S *	1/1967	Levy	.....	D19/57
D221,033 S *	6/1971	Wakai	.....	D19/43
D273,400 S *	4/1984	Zierhut	.....	D19/57
D284,676 S *	7/1986	Malm	.....	D19/51
D328,311 S *	7/1992	Nitta	.....	D19/49
5,174,672 A *	12/1992	Towsend	.....	401/6
5,230,578 A *	7/1993	Fuhrmann et al.	.....	401/202
D366,669 S *	1/1996	McCartney et al.	.....	D19/42
D374,460 S *	10/1996	Young	.....	D19/48
D375,323 S *	11/1996	Young	.....	D19/49
D377,194 S *	1/1997	Young	.....	D19/48
5,599,127 A *	2/1997	Fuhrmann et al.	.....	401/202
D379,372 S *	5/1997	Young	.....	D19/49
D383,780 S *	9/1997	Young	.....	D19/49
D391,153 S *	2/1998	Poisson et al.	.....	D19/48
D394,673 S *	5/1998	Moorthy et al.	.....	D19/49
D402,312 S *	12/1998	Chevalier et al.	.....	D19/57

(Continued)

**OTHER PUBLICATIONS**

Jiang, L., "Ball Point Pen," U.S. Appl. No. 29/423,977, filed Jun. 6, 2012.

(Continued)

*Primary Examiner* — Elizabeth Albert

(74) *Attorney, Agent, or Firm* — Christensen O'Connor Johnson Kindness PLLC

(57) **CLAIM**

The ornamental design for a pen, as shown and described.

**DESCRIPTION**

FIG. 1 is a lower front right perspective view of a pen showing my new design.

FIG. 2 is a front elevation view thereof;

FIG. 3 is a rear elevation view thereof;

FIG. 4 is a right side elevation view thereof, with the left side elevation view being a minor image of the right side elevation view;

FIG. 5 is an enlarged top plan view thereof;

FIG. 6 is an enlarged bottom plan view thereof;

FIG. 7 is a lower front right perspective view of the cap of the pen shown in FIG. 1, shown without the pen body for convenience of illustration;

FIG. 8 is a front elevation view thereof;

FIG. 9 is a rear elevation view thereof;

FIG. 10 is a right side elevation view thereof, with the left side elevation view being a mirror image of the right side elevation view;

FIG. 11 is an enlarged top plan view thereof; and,

FIG. 12 is an enlarged bottom plan view thereof.

The broken lines shown in FIGS. 5, 6, 11, and 12 illustrate environmental subject matter and form no part of the claimed design.

**1 Claim, 6 Drawing Sheets**



(56)

**References Cited**

U.S. PATENT DOCUMENTS

D530,745 S 10/2006 Kent  
D530,748 S \* 10/2006 Kent et al. .... D19/57  
D546,386 S \* 7/2007 Qiu ..... D19/43  
D546,387 S 7/2007 Qiu  
D547,802 S \* 7/2007 Jeon ..... D19/43  
D549,775 S \* 8/2007 Kent et al. .... D19/48  
D612,426 S \* 3/2010 Suero et al. .... D19/41  
D641,787 S \* 7/2011 Tan ..... D19/48  
D647,961 S \* 11/2011 Zhang ..... D19/43  
D648,386 S \* 11/2011 Zhang ..... D19/43  
D655,337 S 3/2012 Zhang  
D661,736 S \* 6/2012 Zhang ..... D19/43  
D662,977 S \* 7/2012 Liang ..... D19/43  
D662,980 S \* 7/2012 Jiang ..... D19/43  
D662,981 S 7/2012 Xie

D667,875 S \* 9/2012 Liang ..... D19/43  
D668,292 S \* 10/2012 Chen ..... D19/49  
D672,808 S \* 12/2012 Liang et al. .... D19/43  
D672,809 S \* 12/2012 Jiang et al. .... D19/43

OTHER PUBLICATIONS

Jiang, L., "Ball Point Pen," U.S. Appl. No. 29/423,984, filed Jun. 6, 2012.  
Liang, W., "Pen," U.S. Appl. No. 29/389,630, filed Apr. 14, 2011.  
Zhang, B., "Pen," U.S. Appl. No. 29/416,059, filed Mar. 16, 2012.  
Zhang, B., "Pen," U.S. Appl. No. 29/416,291, filed Mar. 20, 2012.  
Zhang, B., "Pen Cap," U.S. Appl. No. 29/416,054, filed Mar. 16, 2012.  
Zhang, B., "Pen Cap," U.S. Appl. No. 29/416,294, filed Mar. 20, 2012.

\* cited by examiner

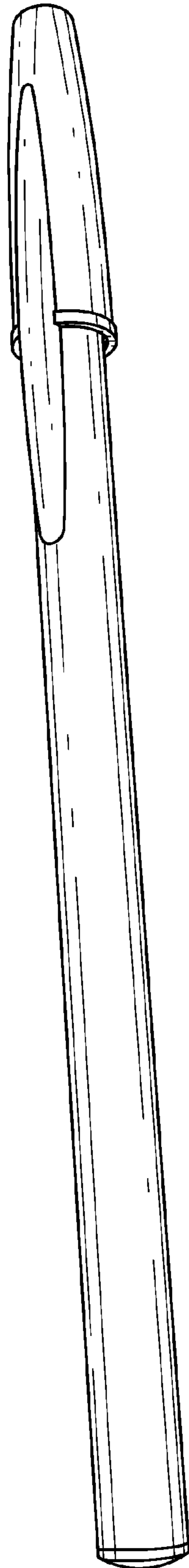

*Fig. 1.*

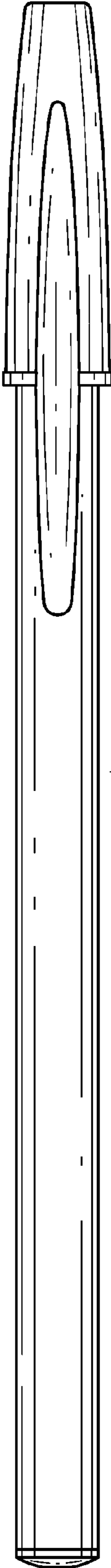

*Fig.2.*

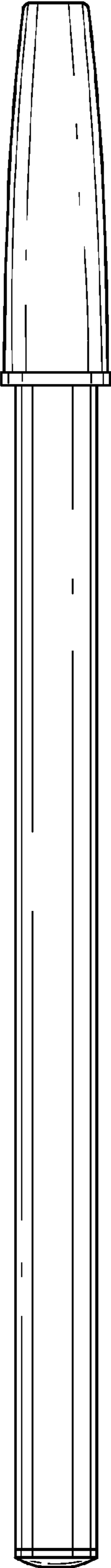

*Fig.3.*

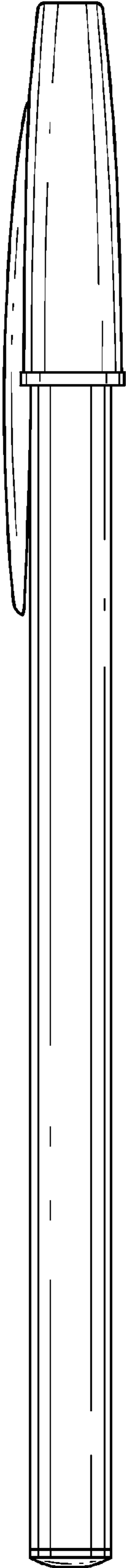

*Fig.4.*

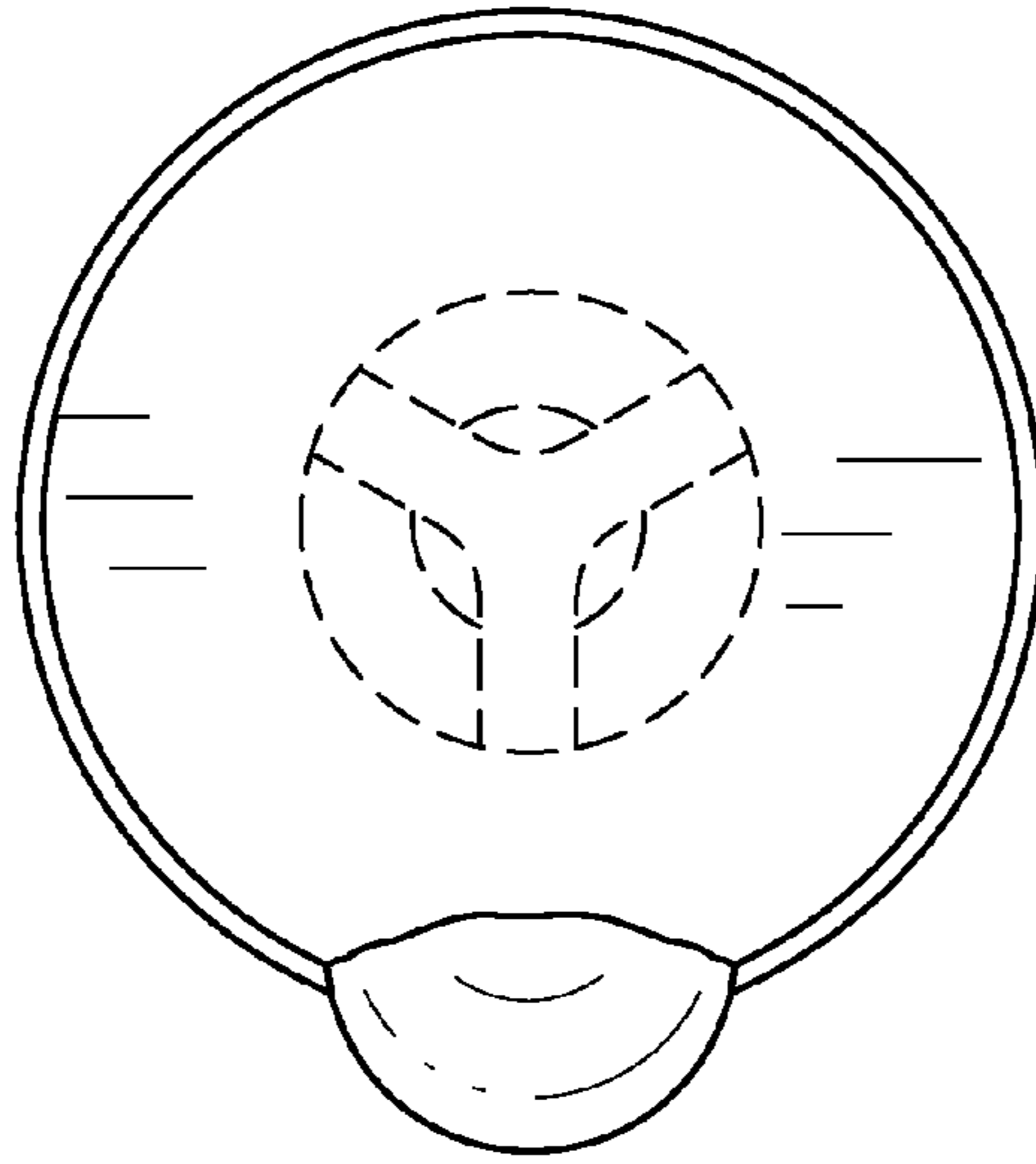

*Fig. 5.*

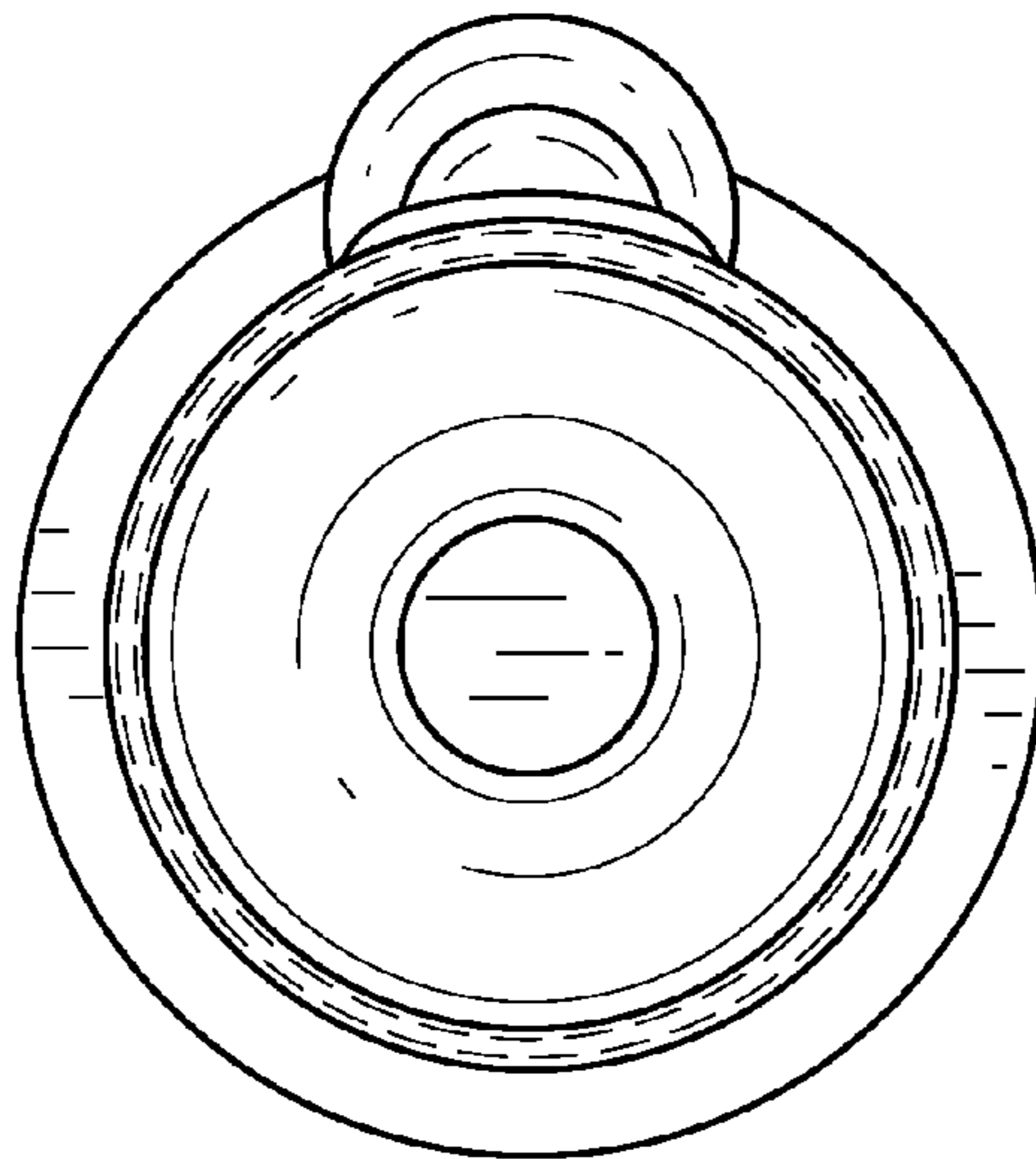

*Fig. 6.*



*Fig. 7.*

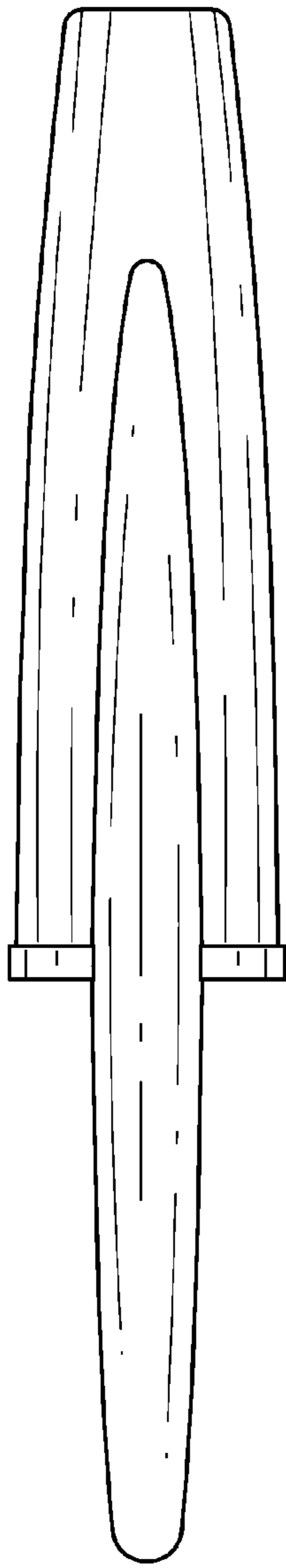

*Fig. 8.*

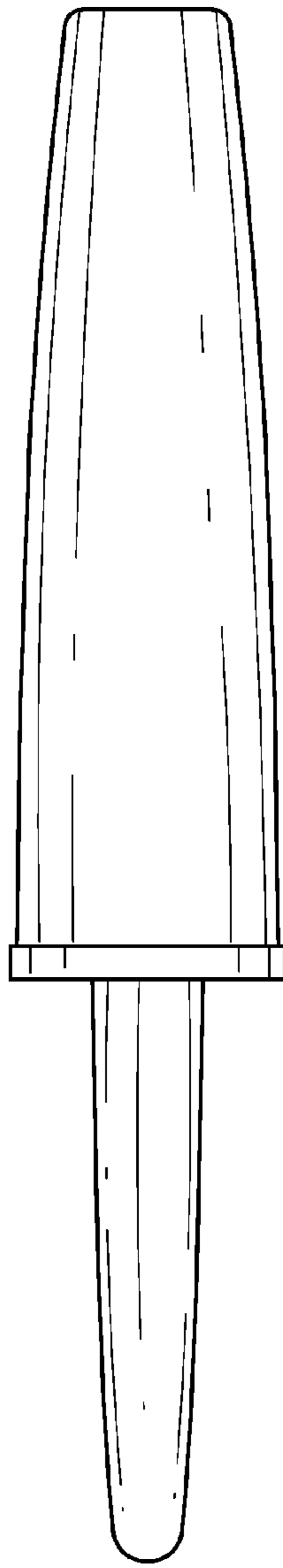

*Fig. 9.*

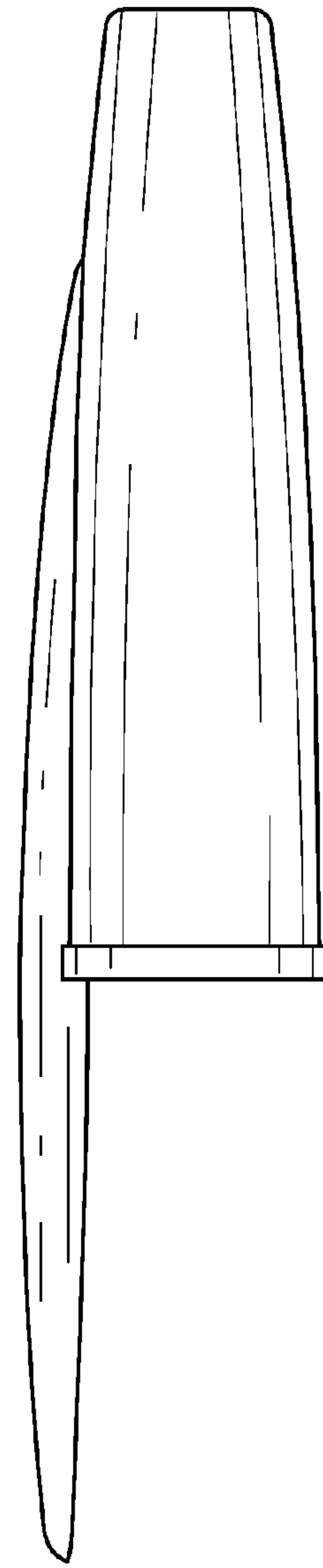

*Fig. 10.*

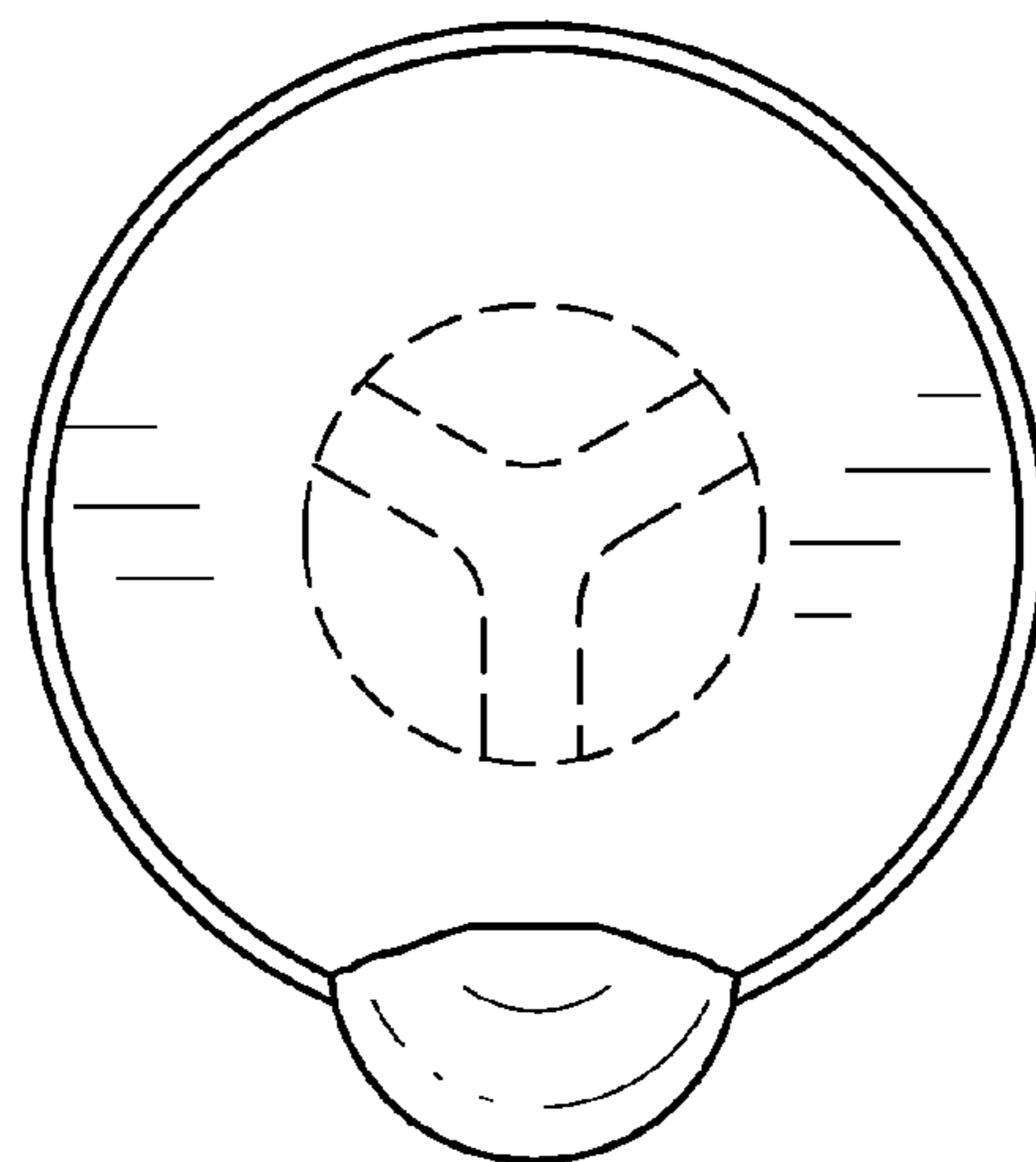

*Fig. 11.*

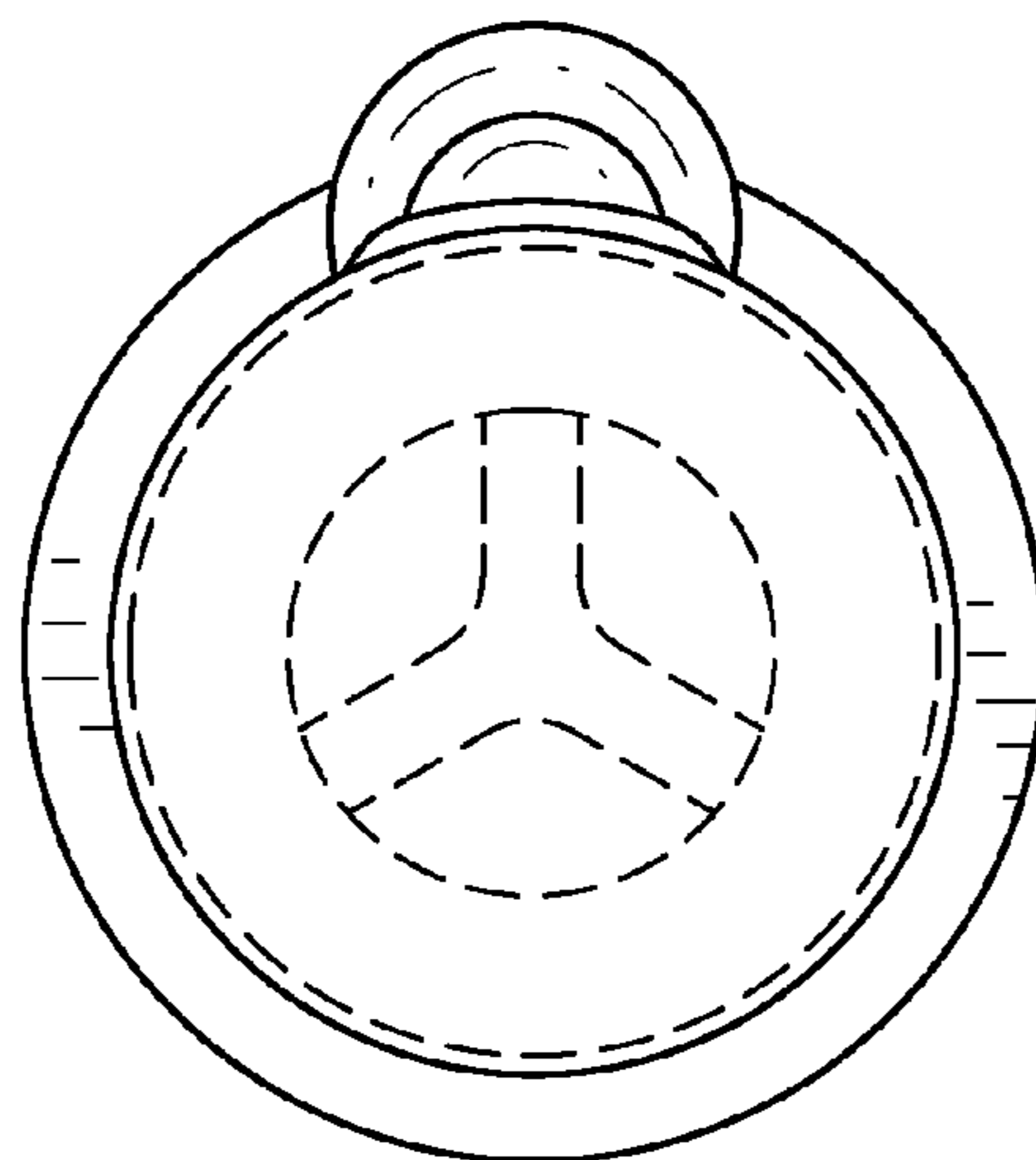

*Fig. 12.*



UNITED STATES PATENT AND TRADEMARK OFFICE  
**CERTIFICATE OF CORRECTION**

PATENT NO. : D693,876 S  
APPLICATION NO. : 29/423979  
DATED : November 19, 2013  
INVENTOR(S) : L. Jiang

Page 1 of 1

It is certified that error appears in the above-identified patent and that said Letters Patent is hereby corrected as shown below:

Title Page

Item (57)	Description	“a minor image” should read --a mirror image--
Pg. 1, col. 2	line 6 of text	

Signed and Sealed this  
First Day of April, 2014



Michelle K. Lee  
*Deputy Director of the United States Patent and Trademark Office*