

US00D693851S

(12) **United States Design Patent**
Fujiwara

(10) **Patent No.:** **US D693,851 S**

(45) **Date of Patent:** **** Nov. 19, 2013**

(54) **TILLER**

(71) Applicant: **Honda Motor Co., Ltd**, Tokyo (JP)

(72) Inventor: **Masato Fujiwara**, Wako (JP)

(73) Assignee: **Honda Motor Co., Ltd**, Tokyo (JP)

(**) Term: **14 Years**

(21) Appl. No.: **29/451,180**

(22) Filed: **Mar. 28, 2013**

(30) **Foreign Application Priority Data**

Oct. 3, 2012 (JP) 2012-024150

(51) **LOC (9) Cl.** **15-03**

(52) **U.S. Cl.**
USPC **D15/11**

(58) **Field of Classification Search**
USPC D15/10-12, 17, 28, 31; 172/41-44, 74,
172/260, 256, 250, 48, 72, 351, 365, 329,
172/57, 518; 180/53.1; 56/16.7
See application file for complete search history.

(56) **References Cited**

U.S. PATENT DOCUMENTS

D203,347 S *	12/1965	Davies, III	D15/12
D206,274 S *	11/1966	Davies, III	D15/12
D416,026 S *	11/1999	Ohsumi et al.	D15/12
D474,204 S *	5/2003	Abenroth	D15/11
D475,067 S *	5/2003	Ito et al.	D15/12
D515,592 S *	2/2006	Thackery	D15/11
D523,026 S *	6/2006	Vaughn	D15/12
D568,341 S *	5/2008	Vaughn	D15/11
D591,774 S *	5/2009	Kokitkar et al.	D15/28
D591,775 S *	5/2009	Kokitkar et al.	D15/28
D613,772 S	4/2010	Azuma	

D635,153 S *	3/2011	Gerbaud et al.	D15/12
D654,509 S *	2/2012	Baetica	D15/12
D654,510 S *	2/2012	Baetica	D15/12
2004/0140108 A1 *	7/2004	Yamazaki et al.	172/42
2004/0194982 A1 *	10/2004	Fukuzumi et al.	172/42

* cited by examiner

Primary Examiner — Mark Goodwin

(74) *Attorney, Agent, or Firm* — Westerman, Hattori, Daniels & Adrian, LLP

(57) **CLAIM**

The ornamental design for a tiller, as shown and described.

DESCRIPTION

FIG. 1 is a left side perspective view of a tiller showing my new design.

FIG. 2 is a right side perspective view thereof.

FIG. 3 is a front elevation view thereof.

FIG. 4 is a rear elevation view thereof

FIG. 5 is a top plan view thereof.

FIG. 6 is a bottom plan view thereof.

FIG. 7 is a left side elevation view thereof.

FIG. 8 is a right side elevation view thereof.

FIG. 9 is an enlarged perspective view from the left side thereof.

FIG. 10 is an enlarged left side elevation view thereof.

FIG. 11 is an enlarged rear elevation view thereof.

FIG. 12 is an enlarged referential perspective view from the left side of the claimed design; and,

FIG. 13 is an enlarged referential perspective view from the right side of the claimed design.

The portions shown in broken lines are for the purpose of showing environmental structure only and form no part of the claimed design.

1 Claim, 13 Drawing Sheets

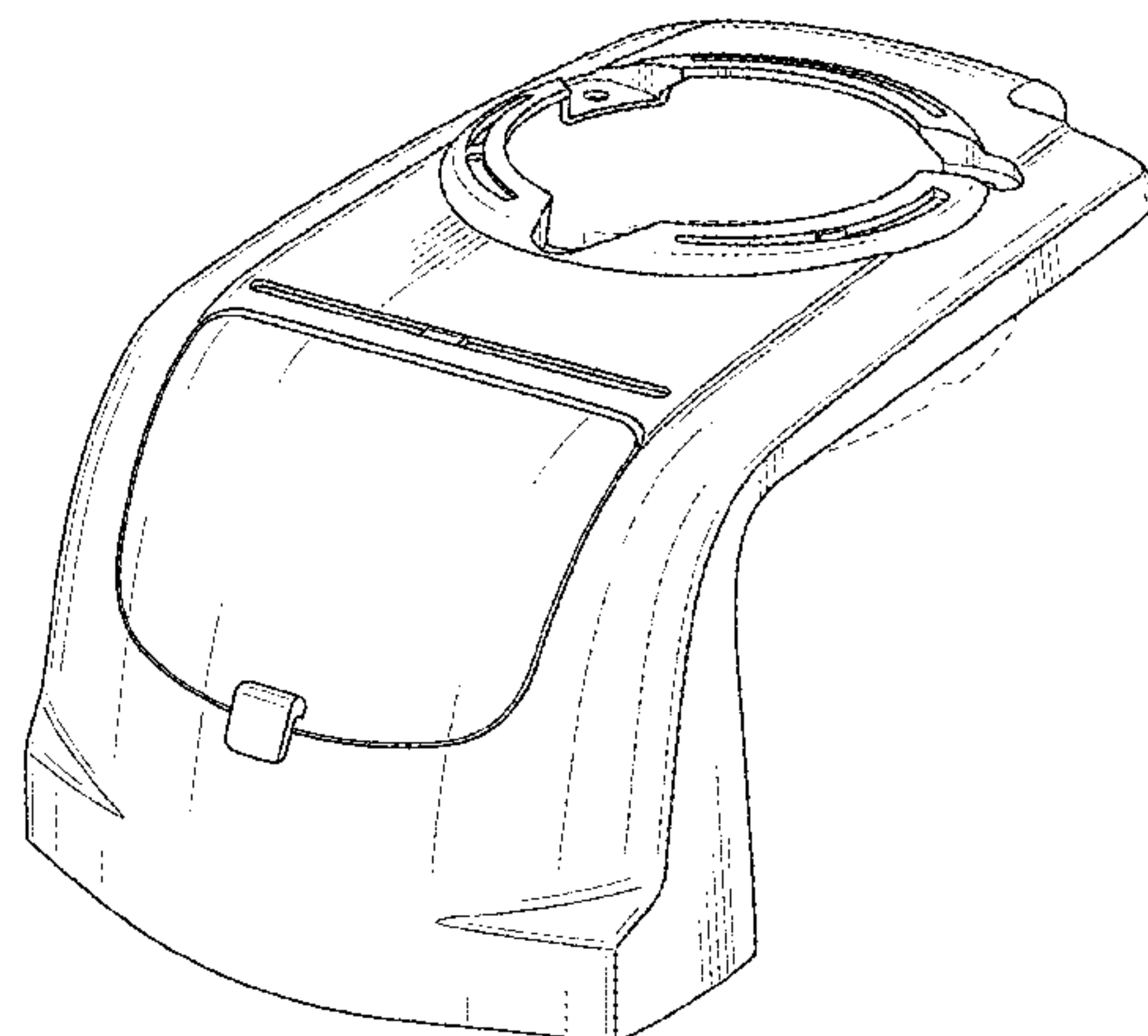
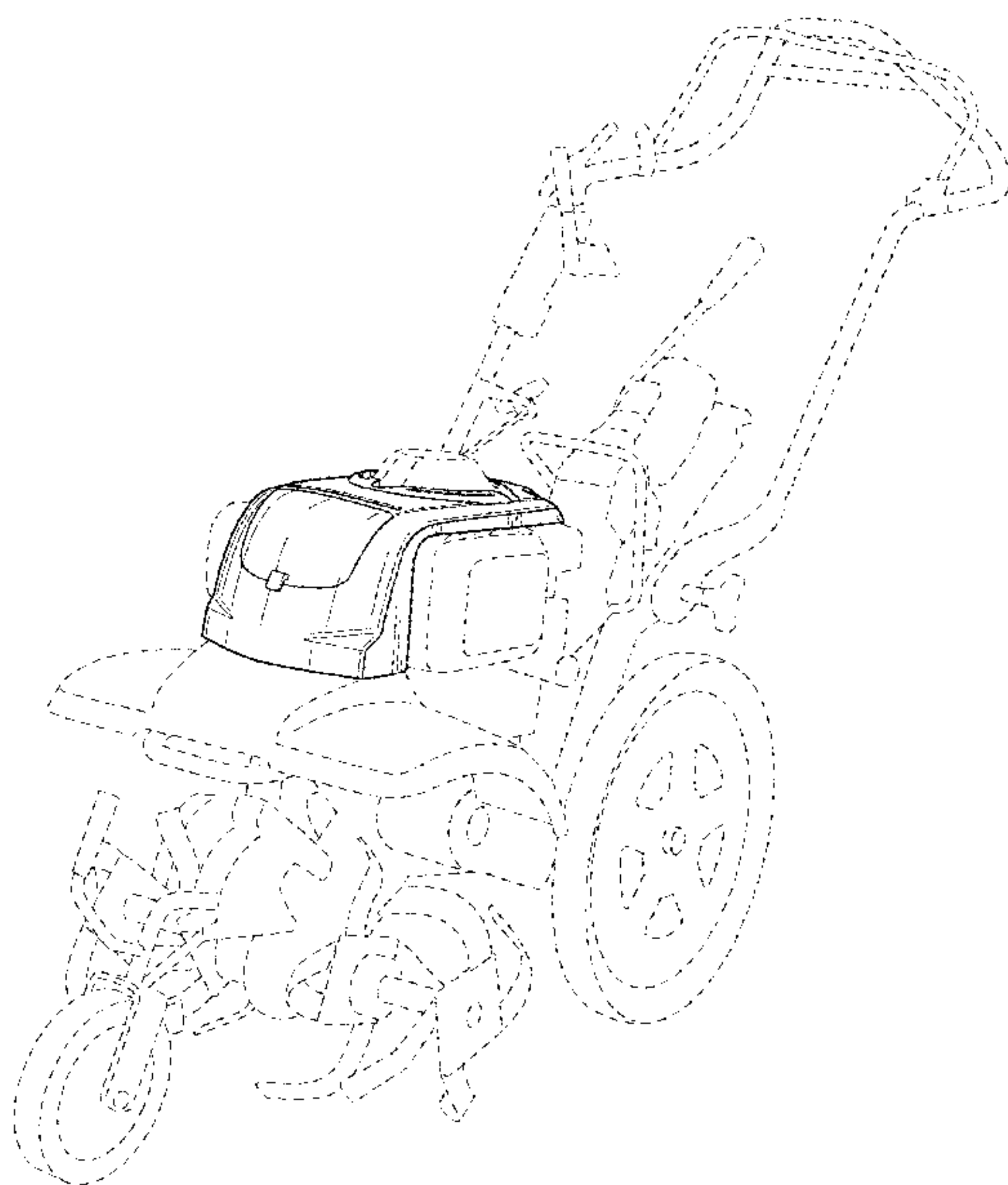

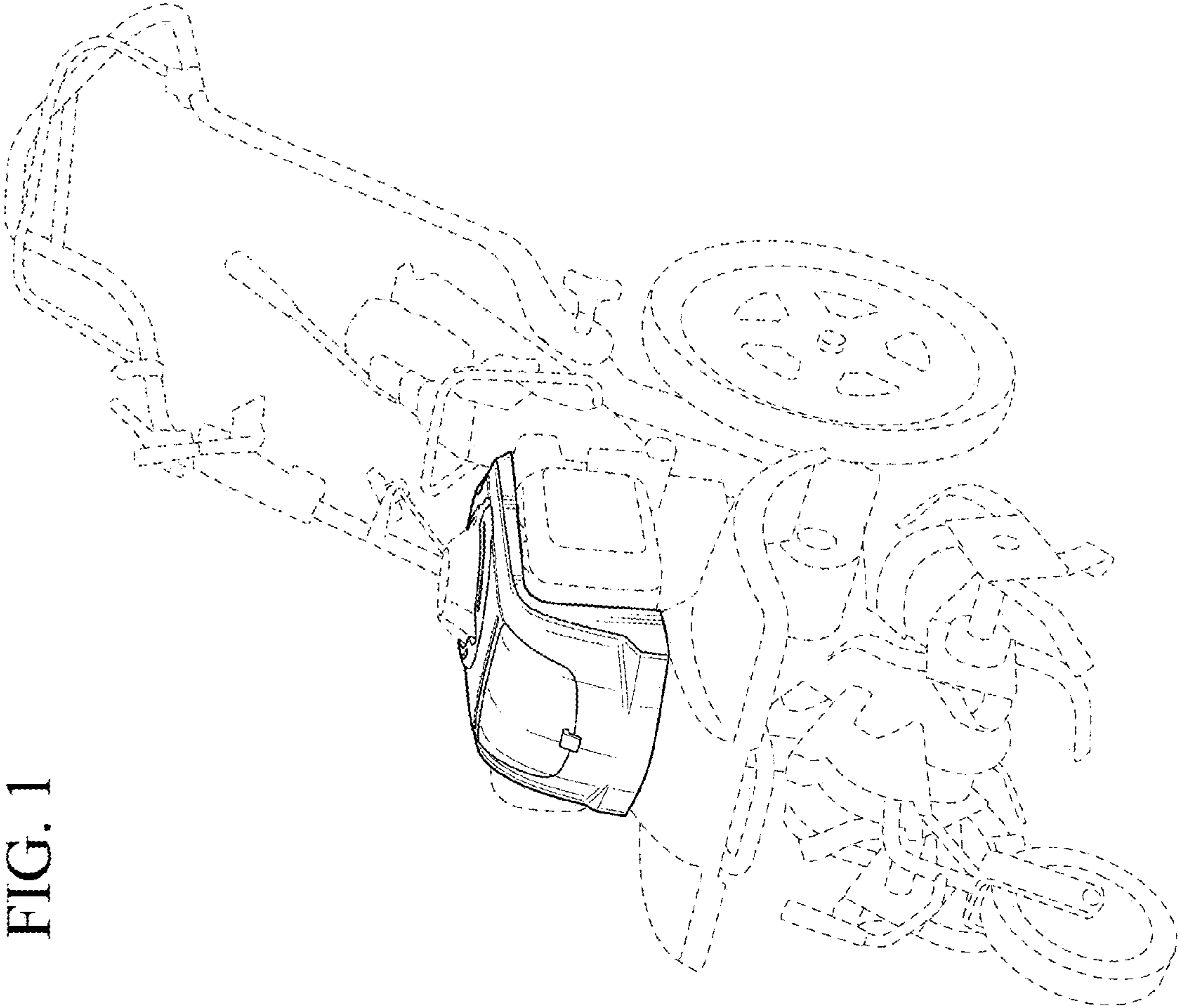

FIG. 1

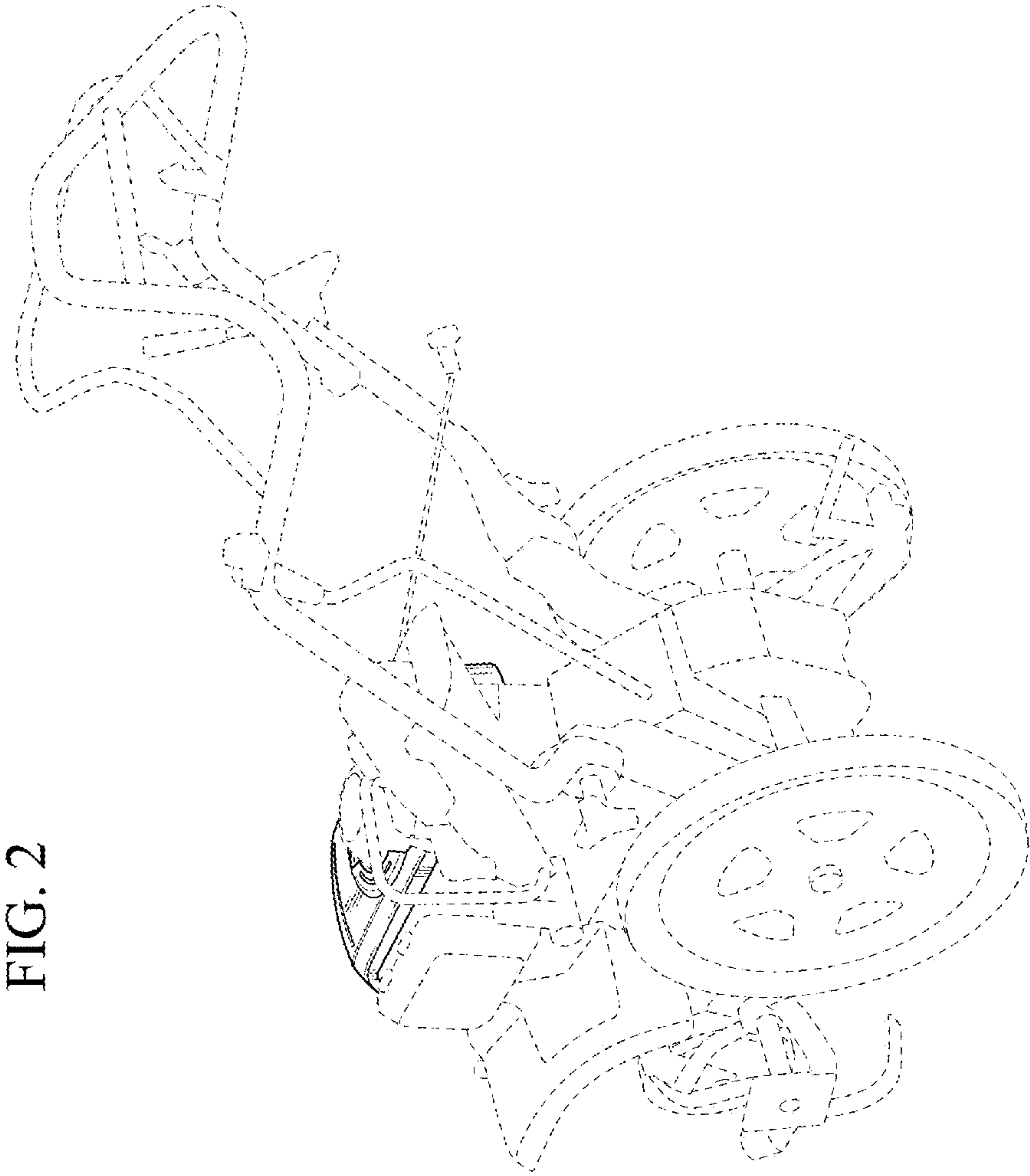

FIG. 2

FIG. 3

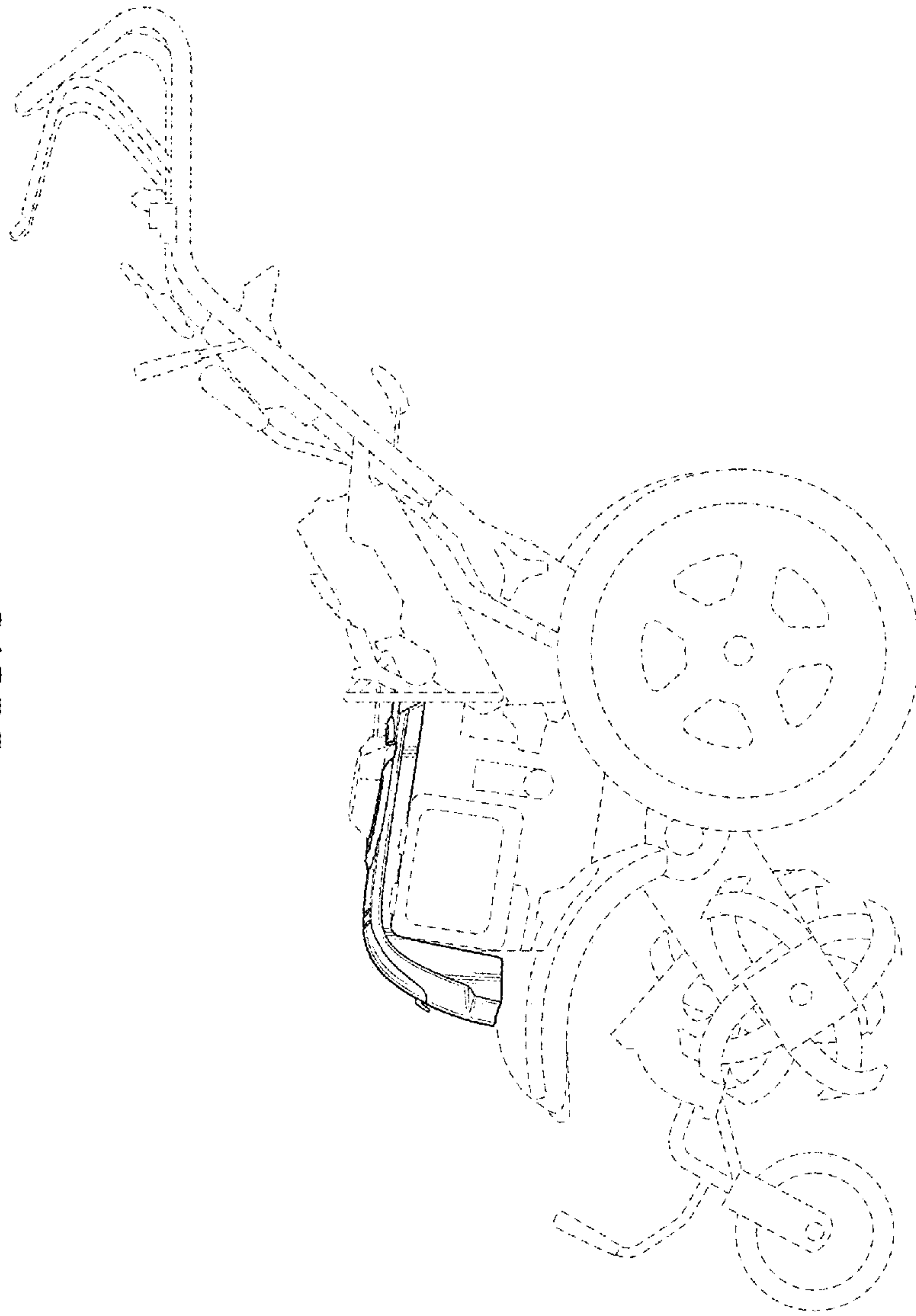

FIG. 4

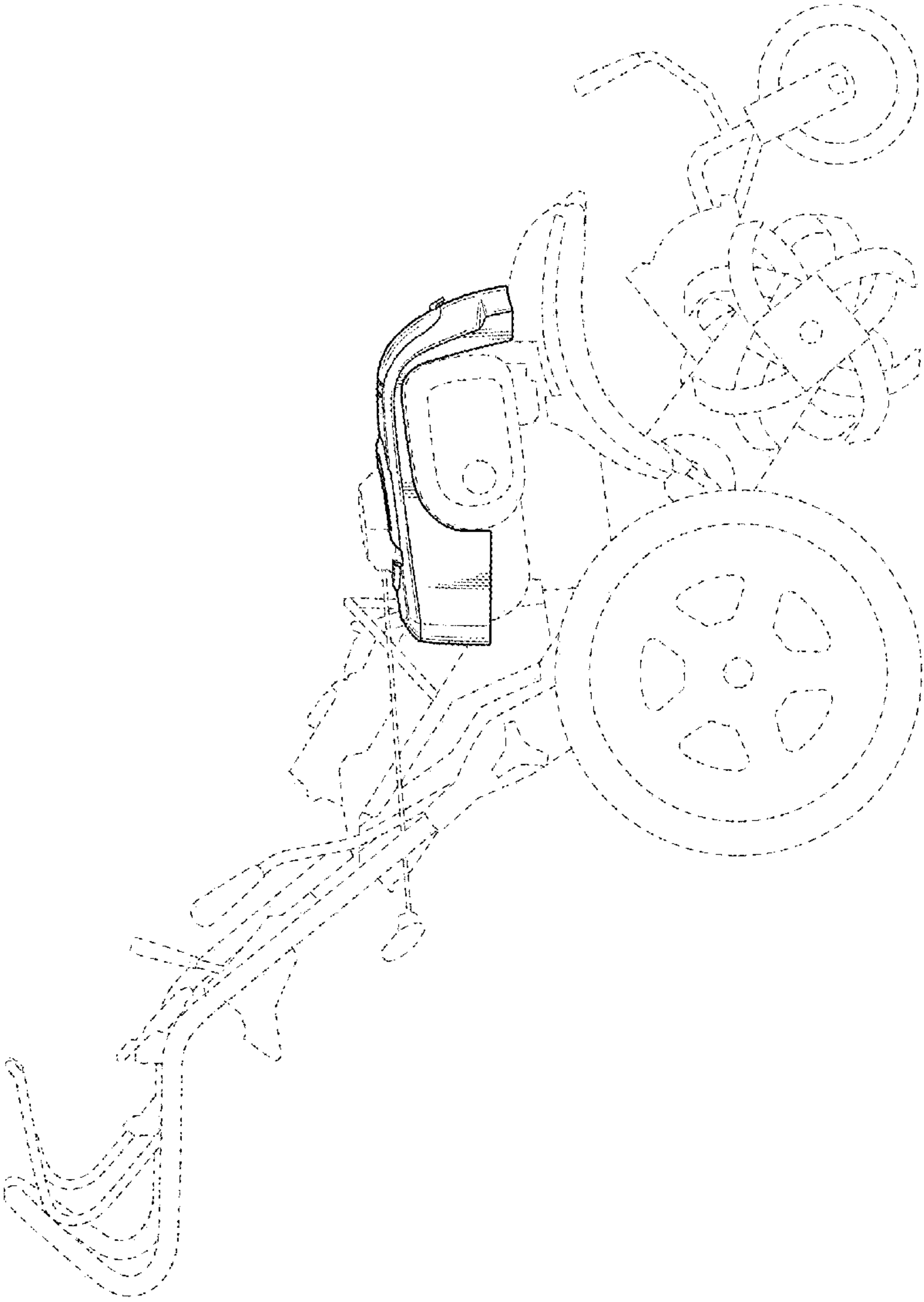

FIG. 5

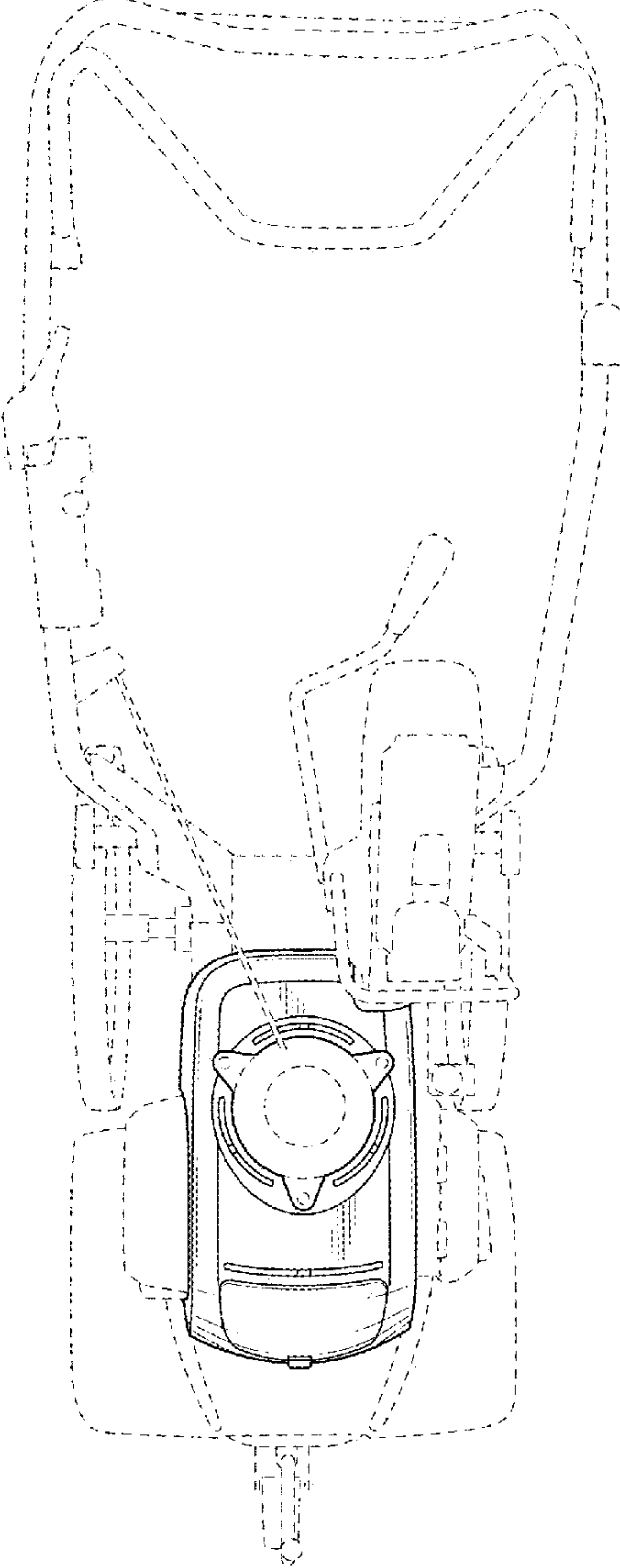
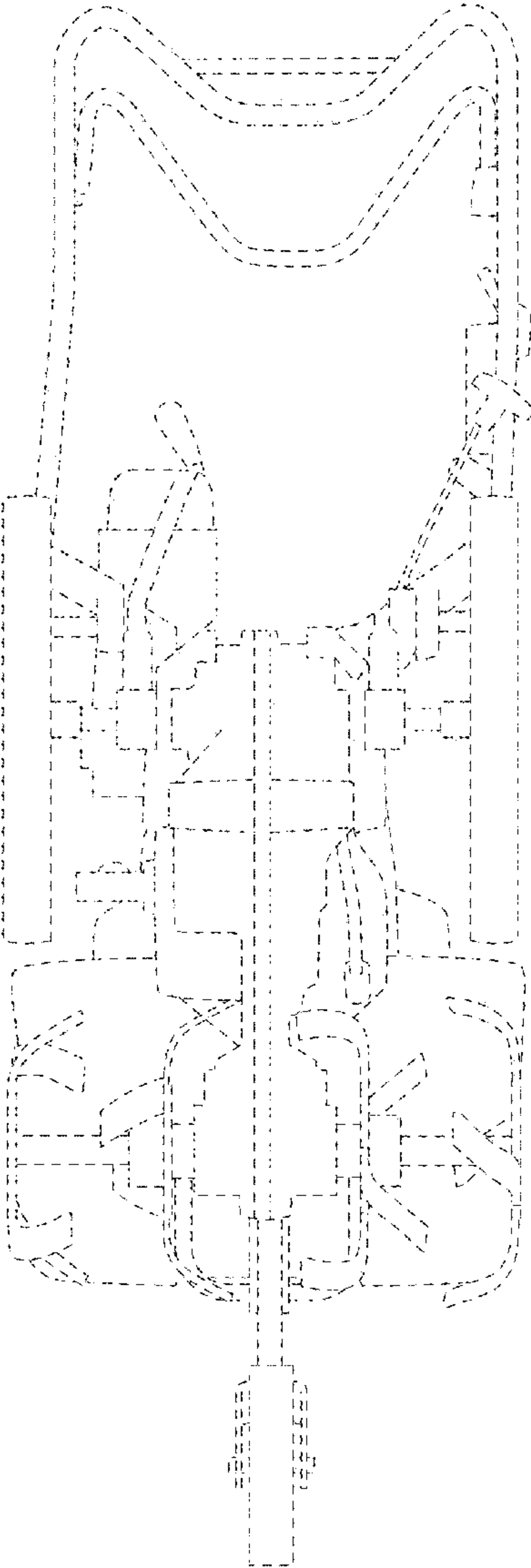

FIG. 6



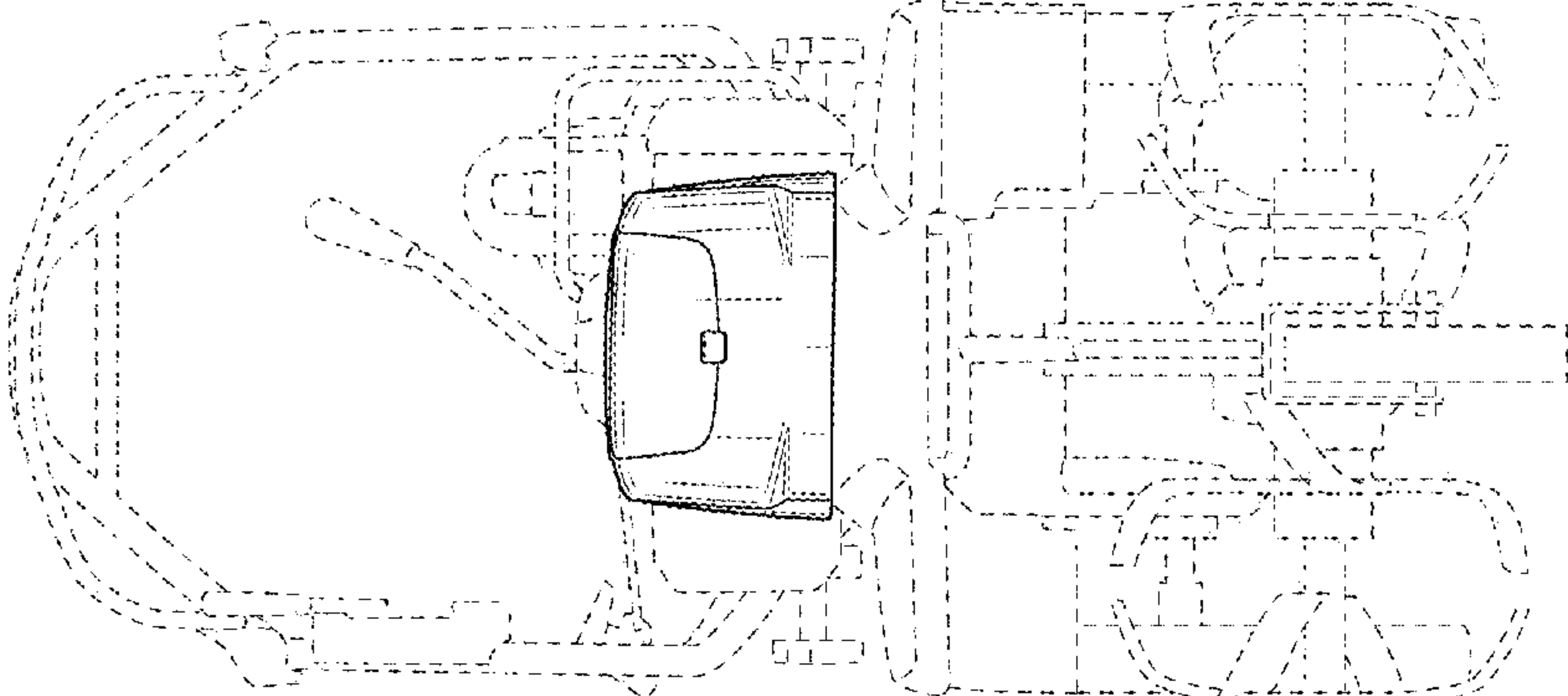

FIG. 7

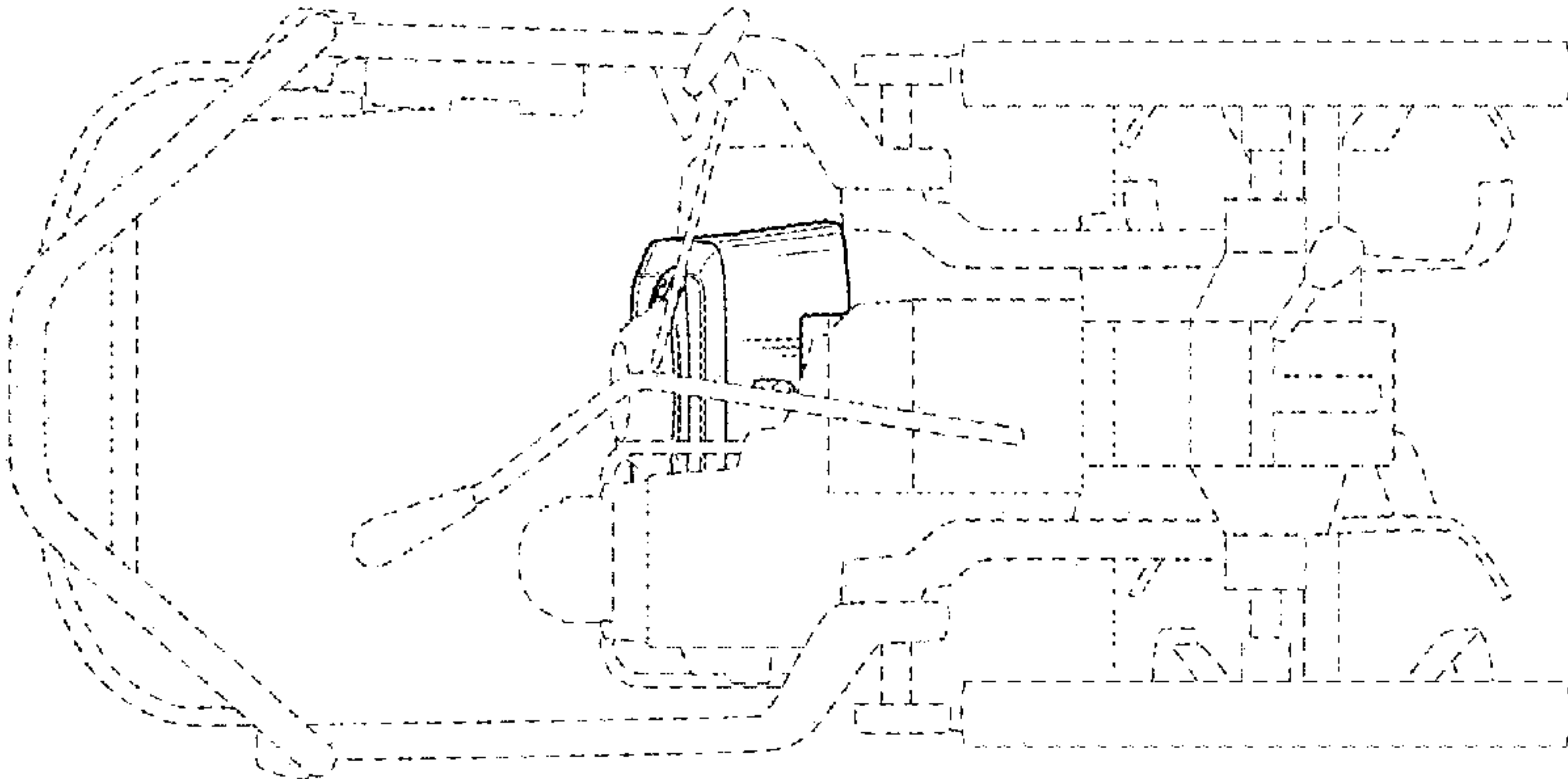

FIG. 8

FIG. 9

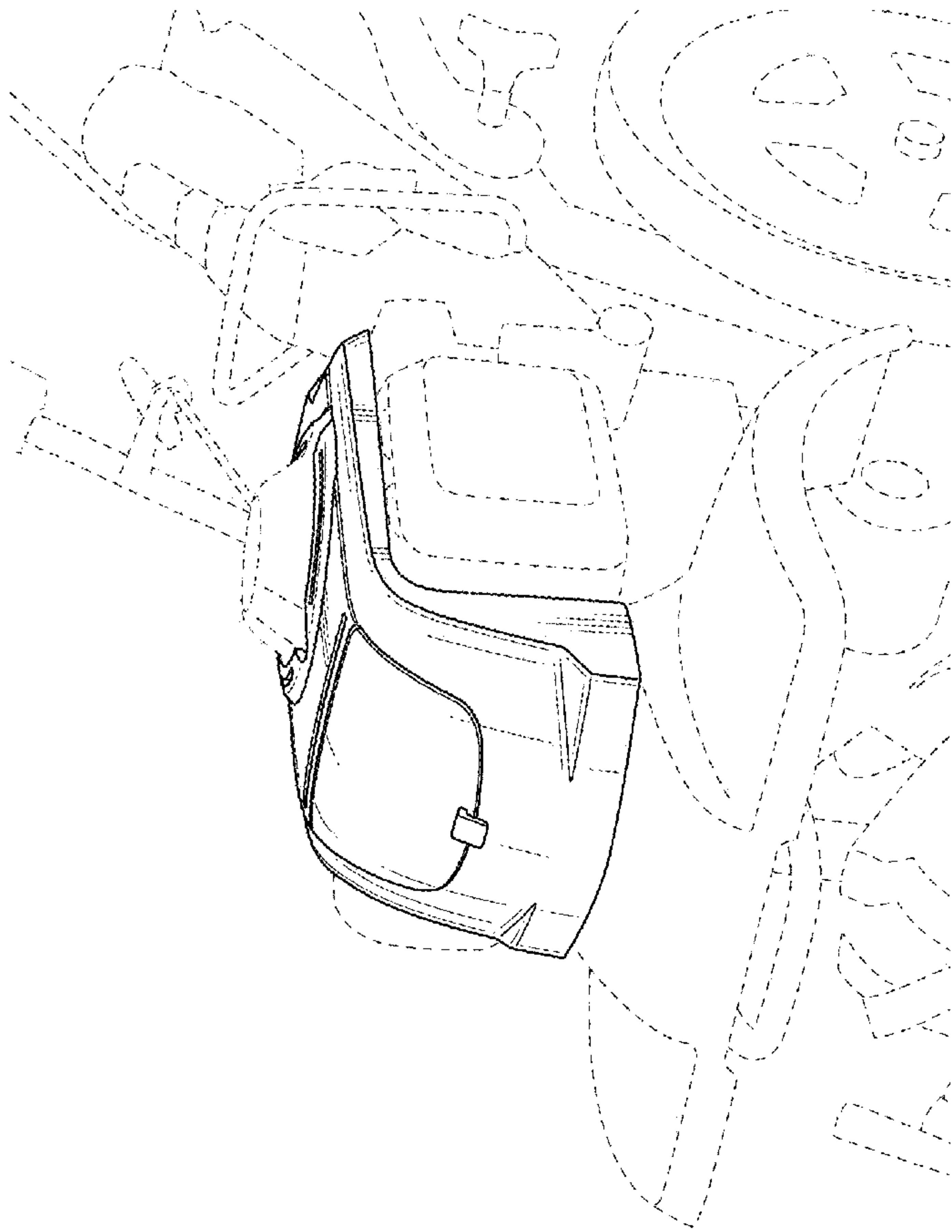

FIG. 10

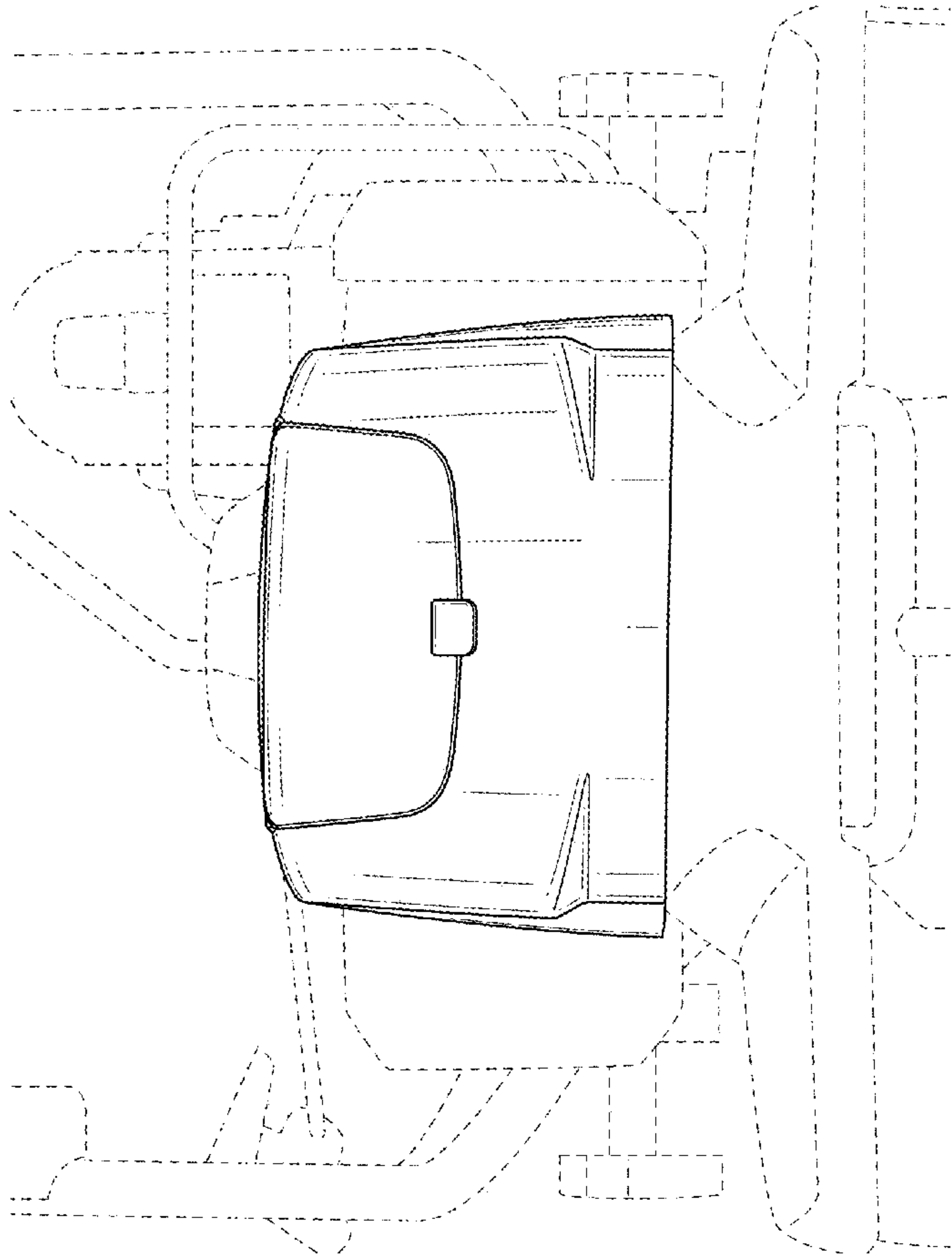

FIG. 11

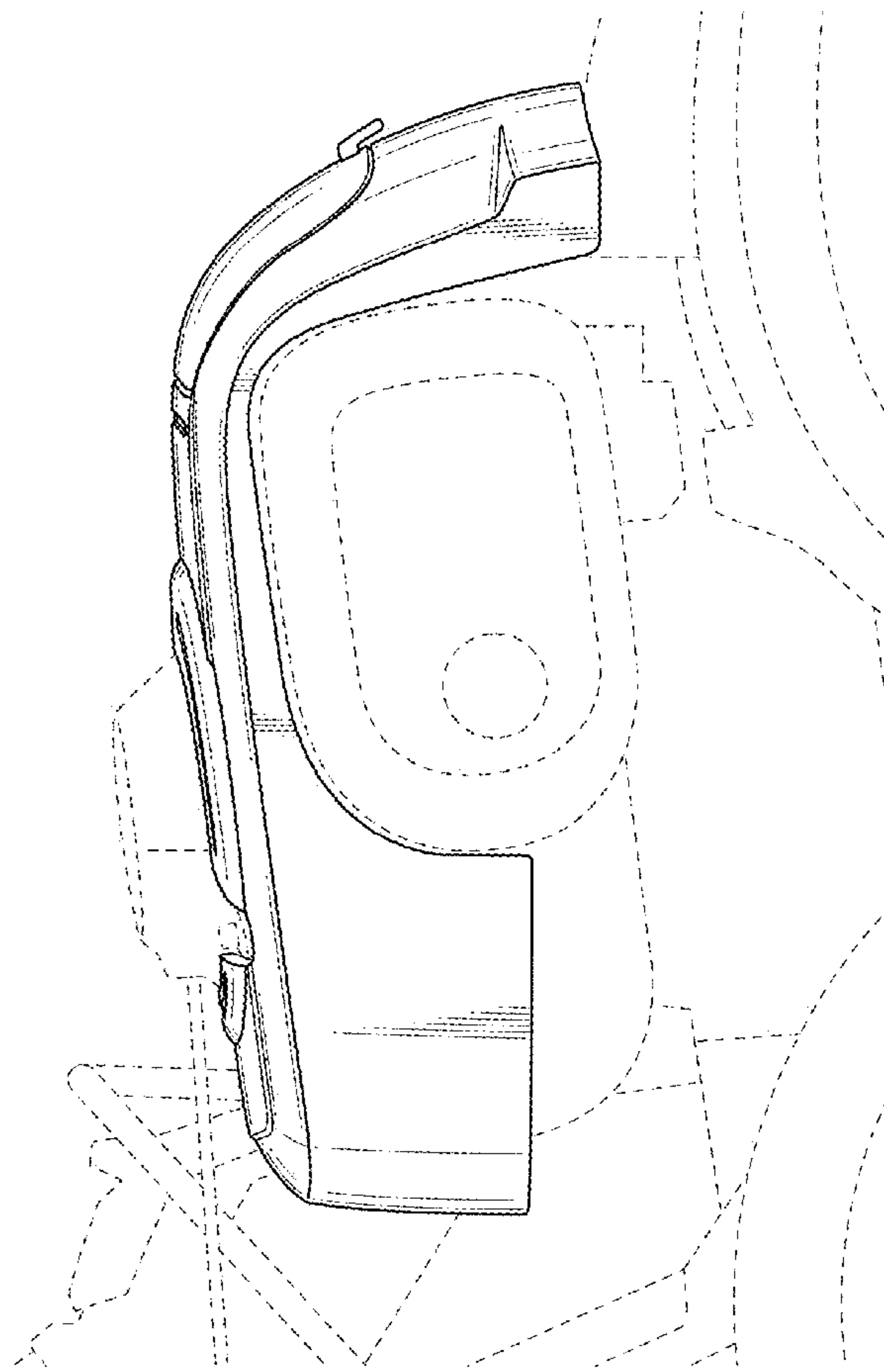

FIG. 12

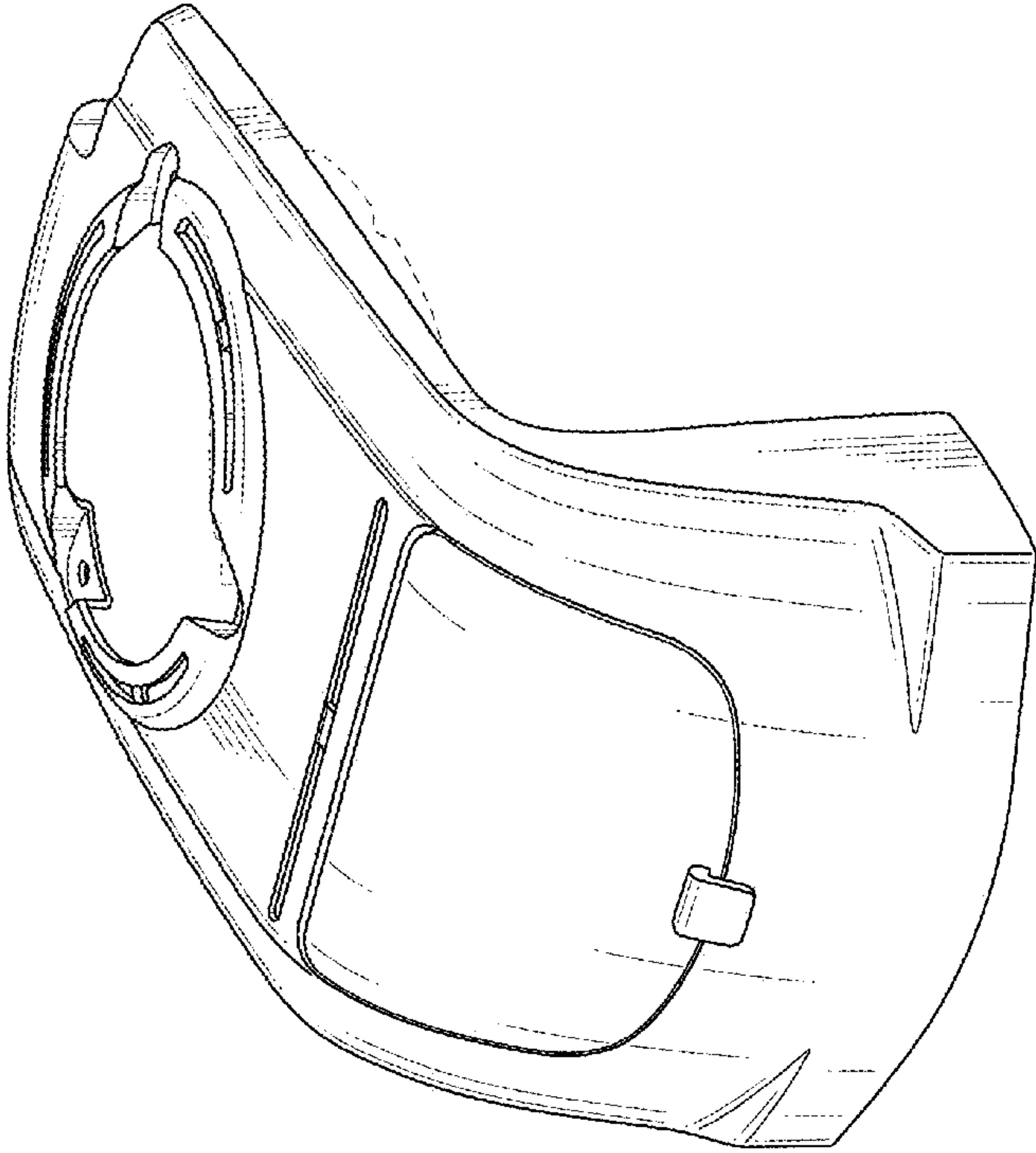

FIG. 13

