

US00D693695S

(12) **United States Design Patent**  
**Limback**

(10) **Patent No.:** **US D693,695 S**  
(45) **Date of Patent:** **\*\* Nov. 19, 2013**

(54) **PACKAGE FOR PRODUCT**

(75) Inventor: **Nancy Gail Limback**, Valley Park, MO  
(US)

(73) Assignee: **Aventisub II Inc.**, Greenville, DE (US)

(\*\*) Term: **14 Years**

(21) Appl. No.: **29/416,882**

(22) Filed: **Mar. 28, 2012**

(51) **LOC (9) Cl.** ..... **09-01**

(52) **U.S. Cl.**

USPC ..... **D9/652**; D9/732

(58) **Field of Classification Search**

USPC ..... D9/600, 652, 730-733, 414-415, 420,  
D9/423-426; 206/457, 461-471, 495

See application file for complete search history.

(56) **References Cited**

**U.S. PATENT DOCUMENTS**

D58,905 S	9/1921	Harrington	
D117,605 S *	11/1939	Blunt .....	D9/652
2,317,860 A	4/1943	Sørensen	
D190,530 S	6/1961	Bender et al.	
3,054,503 A	9/1962	Hartman, Jr. et al.	
3,122,441 A	2/1964	Smith	
D200,000 S	1/1965	Richards et al.	
3,255,928 A	6/1966	Foster	
3,331,495 A	7/1967	Leckzik et al.	
3,387,699 A	6/1968	Heller	
3,429,426 A	2/1969	Wolf et al.	
3,540,579 A	11/1970	Hellstrom	
D220,750 S	5/1971	Artz	
D220,752 S *	5/1971	Artz .....	D9/425
3,620,411 A	11/1971	Rump	
D234,294 S *	2/1975	Gorman .....	D9/732
D253,040 S	10/1979	Fournier et al.	
D253,167 S	10/1979	Fournier et al.	
D253,222 S	10/1979	Fournier et al.	
D253,515 S	11/1979	Meierhoefer	

D253,516 S	11/1979	Meierhoefer	
D253,751 S	12/1979	Meierhoefer	
4,266,666 A	5/1981	Kuchenbecker	
D271,283 S *	11/1983	Taylor .....	D9/415
4,537,312 A	8/1985	Intini	
D280,387 S	9/1985	Morgan	
4,574,951 A	3/1986	Weaver	
D285,176 S	8/1986	Kodousek et al.	

(Continued)

**FOREIGN PATENT DOCUMENTS**

WO 2007/141869 A1 12/2007

**OTHER PUBLICATIONS**

U.S. Notice of Allowance dated Mar. 25, 2013 issued in U.S. Appl. No. 29/416,878.

(Continued)

*Primary Examiner* — Sandra Morris

(74) *Attorney, Agent, or Firm* — Scully, Scott, Murphy & Presser, P.C.

(57) **CLAIM**

The ornamental design for a package for product, as shown and described.

**DESCRIPTION**

FIG. 1 is a perspective view of a package for product showing my new design;  
FIG. 2 is a front view thereof;  
FIG. 3 is a rear view thereof;  
FIG. 4 is a side view thereof;  
FIG. 5 is an opposite side view thereof;  
FIG. 6 is a top view thereof; and,  
FIG. 7 is a bottom view thereof.  
The portions indicated in broken lines are for illustrative purposes only and form no part of the claimed design.

**1 Claim, 5 Drawing Sheets**

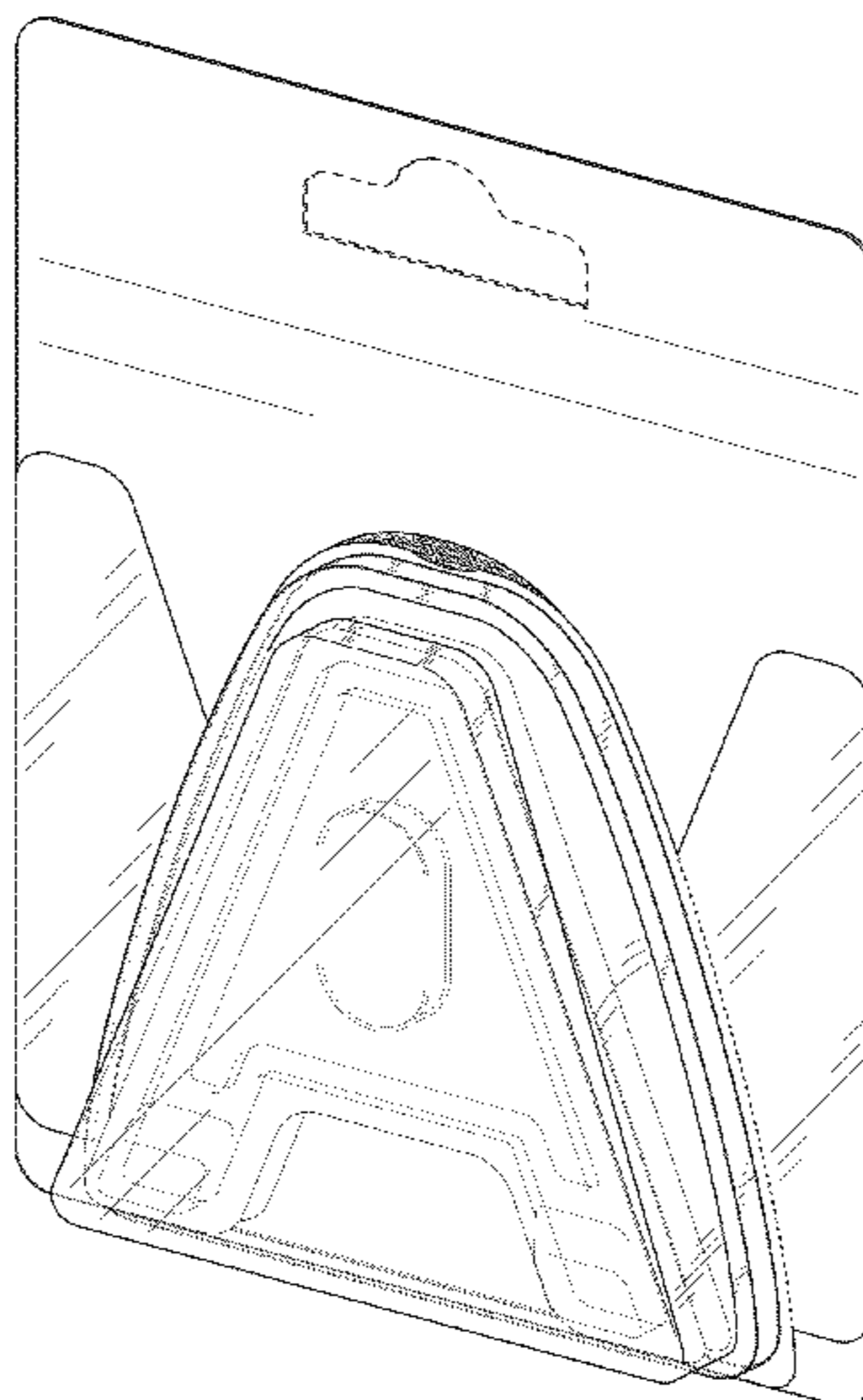

(56)

References Cited

U.S. PATENT DOCUMENTS

D286,140 S	10/1986	Kodousek et al.	D373,530 S	9/1996	Levy et al.
4,660,991 A	4/1987	Simon	5,555,707 A	9/1996	Schwenger
4,805,377 A	2/1989	Carter	5,560,490 A	10/1996	Chawla
4,817,819 A	4/1989	Kelly	D378,272 S	3/1997	Weatherford et al.
4,838,425 A	6/1989	O'Brien et al.	5,624,036 A	4/1997	Roulin et al.
D303,931 S	10/1989	Miller et al.	5,630,347 A	5/1997	Elvio
4,876,843 A	10/1989	O'Brien et al.	D380,960 S *	7/1997	Blotsky ..... D9/652
D305,000 S	12/1989	Hernandez	D382,474 S	8/1997	Malmborg
4,884,693 A	12/1989	Brütsch	D384,283 S	9/1997	Davies et al.
4,890,763 A	1/1990	Curiel	D385,024 S	10/1997	Roberts
D305,870 S	2/1990	Perkins	D386,681 S	11/1997	Reil
D306,405 S	3/1990	Kuerti	D387,977 S	12/1997	Källgren
D306,825 S	3/1990	Siegel	5,695,063 A	12/1997	Roulin et al.
4,905,866 A	3/1990	Bartell et al.	D391,156 S	2/1998	Stevens
D307,554 S	5/1990	McAlister, Sr.	D392,562 S	3/1998	Lo
4,945,708 A	8/1990	Curiel	D392,802 S	3/1998	Malmborg
4,947,620 A	8/1990	Carter	D392,883 S	3/1998	Ferrin
4,955,481 A	9/1990	Novinski et al.	5,722,563 A	3/1998	Hunts
D311,332 S	10/1990	Miller et al.	5,740,938 A	4/1998	Hofmann et al.
4,962,856 A	10/1990	Carter	D394,003 S *	5/1998	Tate ..... D9/415
D313,182 S *	12/1990	Diepois ..... D9/415	5,752,615 A	5/1998	Hofmann et al.
4,975,015 A	12/1990	Harding	5,756,577 A	5/1998	Gutiérrez-Villarreal
4,988,004 A	1/1991	Intini	5,758,774 A	6/1998	Leblong
4,998,623 A	3/1991	Doull	5,775,505 A	7/1998	Vasquez et al.
5,014,851 A	5/1991	Wick	5,785,180 A	7/1998	Dressel et al.
5,033,251 A	7/1991	Rodriguez	5,786,598 A	7/1998	Clark et al.
5,033,252 A	7/1991	Carter	5,791,478 A	8/1998	Kalvelage et al.
5,040,353 A	8/1991	Evans et al.	5,794,781 A	8/1998	Roulin et al.
D319,577 S *	9/1991	Schwarz ..... D9/652	D398,521 S	9/1998	Coe
5,046,618 A	9/1991	Wood	5,802,804 A	9/1998	Esposti et al.
5,050,739 A	9/1991	Hannan et al.	5,819,940 A	10/1998	Roulin et al.
5,052,558 A	10/1991	Carter	5,833,071 A	11/1998	Ray
5,067,611 A	11/1991	Hagmann et al.	5,833,072 A	11/1998	Lambelet, Jr.
D325,526 S	4/1992	Deguchi et al.	D403,955 S	1/1999	Siegel et al.
5,109,984 A	5/1992	Romick	D404,644 S	1/1999	Meeker
D327,425 S	6/1992	Hamada et al.	5,858,401 A	1/1999	Bhalani et al.
D327,426 S	6/1992	Karita et al.	D405,361 S	2/1999	Cameron et al.
5,129,527 A	7/1992	Lataix	5,873,860 A	2/1999	Kahlert
5,150,793 A	9/1992	Tannenbaum	5,878,887 A	3/1999	Parker et al.
D331,011 S	11/1992	Karita et al.	5,879,612 A	3/1999	Zeiter et al.
D331,012 S	11/1992	Karita et al.	D408,278 S	4/1999	Konop
5,172,812 A	12/1992	Wharton et al.	5,904,249 A	5/1999	Roulin et al.
5,203,455 A	4/1993	Hewelt et al.	D411,445 S	6/1999	Anderson
D336,040 S	6/1993	Philippe	5,911,319 A	6/1999	Porcelli et al.
5,244,091 A	9/1993	Tannenbaum	5,911,325 A	6/1999	Breitler
5,251,757 A	10/1993	Relyea et al.	5,927,500 A	7/1999	Godfrey et al.
5,310,060 A	5/1994	Bitner et al.	5,944,191 A	8/1999	Ray et al.
5,323,587 A	6/1994	Amaranti	D414,106 S	9/1999	Anderson
5,323,907 A	6/1994	Kalvelage	5,954,204 A	9/1999	Grabowski
5,344,018 A	9/1994	Severin	D415,416 S	10/1999	Anderson et al.
D351,343 S	10/1994	Kellar et al.	D416,484 S *	11/1999	Voden ..... D9/415
5,358,118 A	10/1994	Thompson et al.	D417,148 S	11/1999	Anderson et al.
D352,236 S	11/1994	Althaus	5,975,304 A	11/1999	Cain et al.
D352,237 S	11/1994	Reardon et al.	D419,439 S	1/2000	Markovsky et al.
5,360,116 A	11/1994	Schmiletzky	6,010,784 A	1/2000	Peterson
5,363,968 A	11/1994	Soloman	6,024,222 A	2/2000	Friberg et al.
D353,092 S	12/1994	Green	D421,385 S	3/2000	Meeker et al.
D354,911 S	1/1995	Weatherford et al.	D421,899 S	3/2000	Eneroth et al.
5,377,839 A	1/1995	Relyea et al.	D421,900 S	3/2000	Eneroth et al.
5,412,372 A	5/1995	Parkhurst et al.	6,036,016 A	3/2000	Arnold
5,415,321 A	5/1995	Gehlert et al.	6,053,321 A	4/2000	Kayser
D359,678 S	6/1995	Weatherford et al.	6,055,794 A	5/2000	Breitler
D359,679 S	6/1995	Weatherford et al.	D427,061 S	6/2000	Niksich
5,437,371 A	8/1995	Lataix	6,082,544 A	7/2000	Romick
5,442,892 A	8/1995	Burns, III et al.	D430,015 S	8/2000	Himbert et al.
5,450,710 A	9/1995	Jensen et al.	6,109,000 A	8/2000	Conti
5,457,895 A	10/1995	Thompson et al.	D431,459 S *	10/2000	Lee ..... D9/415
5,460,471 A	10/1995	Connor et al.	D431,863 S	10/2000	Richardson
5,469,968 A	11/1995	Matthews et al.	6,135,755 A	10/2000	Zeiter et al.
D366,829 S	2/1996	Chervenak et al.	6,138,830 A	10/2000	Muggli
5,489,025 A	2/1996	Romick	6,155,414 A	12/2000	Vaessen
5,509,773 A	4/1996	Connor et al.	6,155,423 A	12/2000	Katzner et al.
5,522,506 A	6/1996	Roulin et al.	6,161,699 A	12/2000	Gartland
5,529,188 A	6/1996	Coggswell	D438,104 S	2/2001	Hacker et al.
5,549,204 A	8/1996	Toren	D438,461 S *	3/2001	Yamagishi ..... D9/415
			D438,463 S	3/2001	Schill et al.
			D440,871 S	4/2001	Lo
			6,212,791 B1	4/2001	Thompson et al.
			6,212,858 B1	4/2001	Breitler

(56)

References Cited

U.S. PATENT DOCUMENTS

D441,284 S	5/2001	Saur et al.	D507,453 S	7/2005	Mills
D444,056 S	6/2001	Lo	6,925,783 B1	8/2005	Pearson
6,244,442 B1	6/2001	Inoue et al.	6,941,947 B2	9/2005	Young et al.
D444,379 S	7/2001	Assargren et al.	6,951,353 B2	10/2005	Kozlowski et al.
6,269,671 B1	8/2001	Zeiter et al.	D511,452 S	11/2005	Dibnah et al.
6,270,869 B1	8/2001	Zeiter et al.	D511,977 S	11/2005	Saelzer
D449,779 S	10/2001	Otto	6,959,841 B2	11/2005	Vlodek
D449,780 S	10/2001	Corella	6,964,338 B2	11/2005	Kancsar et al.
D450,239 S	11/2001	Otto	6,974,031 B2	12/2005	Kancsar et al.
D451,014 S	11/2001	Otto	6,974,032 B2	12/2005	Intini
D451,015 S	11/2001	Otto	6,978,894 B2	12/2005	Mundt
D451,016 S	11/2001	Dittmar	D513,589 S	1/2006	Grant
6,311,743 B1	11/2001	Baroncini	D513,863 S	1/2006	Wahl et al.
6,329,047 B1	12/2001	Beer et al.	D513,976 S	1/2006	Milan
6,345,717 B1	2/2002	Flewitt	6,988,618 B2	1/2006	DeJonge
6,349,831 B1	2/2002	Buss	D514,308 S	2/2006	Wahl et al.
D454,781 S	3/2002	Assargren et al.	D514,309 S	2/2006	Wahl et al.
6,357,495 B1	3/2002	Baroncini	D514,436 S	2/2006	McGuinness
D455,344 S	4/2002	Assargren et al.	D515,924 S	2/2006	Grant
D455,345 S	4/2002	Assargren et al.	D515,925 S	2/2006	Wahl et al.
D455,953 S	4/2002	Assargren et al.	D515,926 S	2/2006	Wahl et al.
D455,954 S	4/2002	Dittmar	6,997,320 B1	2/2006	Kancsar et al.
6,401,926 B1	6/2002	Lo	7,000,768 B2	2/2006	Morita et al.
6,409,020 B1	6/2002	Lo	D517,410 S	3/2006	Grant
6,411,567 B1	6/2002	Niemiec et al.	D518,721 S	4/2006	Wahl et al.
6,430,984 B2	8/2002	Zeiter et al.	7,025,207 B2	4/2006	Breu et al.
6,439,426 B1	8/2002	Baroncini	D520,357 S	5/2006	Terrasi
6,497,083 B1	12/2002	Garwood et al.	7,038,219 B2	5/2006	Clark et al.
D469,348 S	1/2003	Demus et al.	7,055,296 B2	6/2006	Christ
6,502,374 B1	1/2003	Llorca Chulia	7,063,211 B2	6/2006	Williams-Hartman
6,516,949 B2	2/2003	Fuller et al.	7,067,084 B1	6/2006	Leroy et al.
6,564,934 B1	5/2003	Dischler	7,069,929 B2	7/2006	Young et al.
D476,227 S *	6/2003	Pratt ..... D9/415	7,070,802 B1	7/2006	Bhalani et al.
6,574,166 B2	6/2003	Niemiec	7,080,644 B2	7/2006	Gumaste
D477,158 S	7/2003	Calcerano et al.	7,090,079 B2	8/2006	Ehrlund
6,588,180 B2	7/2003	Heath et al.	7,093,716 B2	8/2006	Intini
6,589,616 B2	7/2003	Muggli et al.	7,104,035 B2	9/2006	Hähnel
6,589,642 B1	7/2003	Miller et al.	7,121,065 B2	10/2006	Christ
6,592,978 B1	7/2003	Miller et al.	7,121,822 B2	10/2006	Heath
6,598,370 B2	7/2003	Baroncini	7,128,100 B2	10/2006	Monti
D478,810 S	8/2003	Wilson	D533,971 S	12/2006	Carter et al.
6,601,876 B1	8/2003	Instance	D534,423 S	1/2007	Tanner
D480,635 S	10/2003	Caroen	7,188,728 B2	3/2007	Williams-Hartman
6,648,575 B2	11/2003	Baroncini	7,192,640 B2	3/2007	Holbert et al.
6,669,236 B1	12/2003	Höllwarth-Oberholz	7,207,440 B2 *	4/2007	Briscoe ..... 206/461
6,673,406 B2	1/2004	Bekele	7,207,441 B2	4/2007	Ritter
6,675,972 B2	1/2004	Patterson	D543,103 S	5/2007	Roche et al.
6,679,382 B1	1/2004	Kancsar et al.	D544,794 S	6/2007	White
6,699,566 B2	3/2004	Zeiter et al.	D545,690 S *	7/2007	Tsutsumi et al. .... D9/732
6,705,467 B1	3/2004	Kancsar et al.	D546,182 S	7/2007	Hanji
6,706,345 B1	3/2004	Yoon	D546,198 S	7/2007	Currie et al.
6,708,825 B2	3/2004	Filion et al.	7,243,798 B2	7/2007	Buss
D489,002 S	4/2004	Meyer et al.	D548,110 S	8/2007	Pugh
6,726,054 B2	4/2004	Fagen et al.	D548,615 S	8/2007	Ristic et al.
D491,459 S	6/2004	Grant	D554,530 S *	11/2007	Tsutsumi et al. .... D9/732
6,757,637 B2	6/2004	Mertens et al.	D556,602 S	12/2007	Clements et al.
6,758,367 B2	7/2004	Hunts	D556,603 S	12/2007	Barnes et al.
D495,134 S	8/2004	Geert-Jensen et al.	D558,336 S	12/2007	Walters et al.
6,793,077 B1	9/2004	Kancsar et al.	D559,706 S	1/2008	Clements et al.
6,802,422 B2	10/2004	Kalvelage et al.	7,318,304 B2	1/2008	Hiddink et al.
6,805,259 B2	10/2004	Stevens et al.	D562,153 S	2/2008	Ruble et al.
6,805,528 B2	10/2004	Monti	7,325,689 B2	2/2008	Buss
6,827,808 B2	12/2004	Fenn	7,325,703 B2	2/2008	Gherdan et al.
6,839,304 B2	1/2005	Niemiec et al.	7,331,460 B2	2/2008	Barndt et al.
D501,790 S	2/2005	Feibelman	7,337,593 B2	3/2008	Blum et al.
6,848,580 B2	2/2005	Paliotta et al.	7,337,906 B2	3/2008	Chang
6,851,874 B2	2/2005	Gonzalez et al.	7,377,394 B2	5/2008	Buss
D504,811 S	5/2005	Haingaertner	D570,171 S	6/2008	Benktzon et al.
D505,320 S	5/2005	Gattefosse et al.	7,383,674 B2	6/2008	Van Eenoo
D505,322 S	5/2005	Guthrie et al.	7,387,206 B2	6/2008	Grosskopf
6,889,690 B2	5/2005	Crowder et al.	7,401,702 B2	7/2008	Hession
6,890,472 B2	5/2005	Heath	D574,704 S	8/2008	Senter
6,896,139 B2	5/2005	Kancsar et al.	7,416,631 B2	8/2008	Pasternicki
D506,680 S	6/2005	Saelzer	7,419,056 B2	9/2008	Gattefosse et al.
6,902,645 B2	6/2005	Miller	7,429,127 B2	9/2008	Walker et al.
			D578,386 S	10/2008	Silvenis et al.
			7,448,182 B2	11/2008	Pearson
			7,448,184 B2	11/2008	Clark et al.
			7,451,761 B2	11/2008	Hicket et al.

(56)

References Cited

U.S. PATENT DOCUMENTS

D581,780 S 12/2008 Senter  
 D582,240 S 12/2008 Benktzon et al.  
 7,464,818 B2 12/2008 Gherdan et al.  
 D585,545 S 1/2009 Carrio et al.  
 7,472,526 B2 1/2009 Pearson  
 D585,638 S 2/2009 Skedelius  
 D585,735 S 2/2009 Vovan et al.  
 D588,471 S 3/2009 Flugel et al.  
 D588,908 S 3/2009 Silvenis et al.  
 D590,245 S 4/2009 Nanda  
 7,516,836 B2 4/2009 Trygar et al.  
 7,523,594 B2 4/2009 Greenwald et al.  
 D592,947 S 5/2009 Neves et al.  
 D594,753 S 6/2009 Eadicicco et al.  
 7,540,383 B2 6/2009 Huffer et al.  
 7,552,824 B2 6/2009 Le et al.  
 D597,418 S 8/2009 Stojek  
 D597,830 S 8/2009 Andersen et al.  
 D598,737 S 8/2009 Neves et al.  
 D598,785 S 8/2009 Stojek  
 D601,012 S 9/2009 Ginsberg et al.  
 7,591,372 B2 9/2009 Gelardi et al.  
 D601,884 S 10/2009 Andre et al.  
 7,607,539 B2 10/2009 Freeze  
 7,617,935 B2 11/2009 Reilley et al.  
 7,623,040 B1 11/2009 Cote  
 D606,856 S 12/2009 Ginsberg et al.  
 7,637,079 B2 12/2009 Klingel et al.  
 7,637,375 B2 12/2009 Sattel et al.  
 7,661,531 B2 2/2010 Intini  
 7,665,610 B2 2/2010 Williams-Hartman  
 7,674,532 B2 3/2010 Einhorn et al.  
 7,685,798 B2 3/2010 Marzocchi  
 D614,045 S 4/2010 Gaudenzi et al.  
 7,690,511 B2 4/2010 Arnold et al.  
 7,699,173 B2 4/2010 Hession  
 7,704,583 B2 4/2010 Heath  
 7,721,880 B2 5/2010 Pearce et al.  
 7,726,485 B2 6/2010 Brollier  
 7,726,486 B2 6/2010 Jones  
 7,735,650 B2 6/2010 Zumbiel  
 D620,359 S 7/2010 Ginsberg et al.  
 D620,375 S 7/2010 Sadler et al.  
 7,748,535 B2 7/2010 Grosskopf  
 7,756,248 B2 7/2010 Beckers et al.  
 7,758,936 B2 7/2010 Spallek et al.  
 D620,812 S 8/2010 Gaudenzi et al.  
 7,784,250 B2 8/2010 Grosskopf  
 D624,399 S 9/2010 Hansen et al.

D624,402 S 9/2010 Hansen et al.  
 D624,403 S 9/2010 Hansen et al.  
 7,793,784 B2 9/2010 Nivala  
 7,798,328 B2 9/2010 Hession  
 7,798,329 B2 9/2010 Gelardi  
 7,799,340 B2 9/2010 Bhalani et al.  
 D624,815 S 10/2010 Hansen et al.  
 7,810,495 B2 10/2010 Gumaste  
 D627,220 S 11/2010 LeMaster et al.  
 D627,239 S 11/2010 Bontorno et al.  
 7,828,147 B2 11/2010 Caracciolo et al.  
 7,828,149 B2 11/2010 Kalvelage et al.  
 7,828,150 B2 11/2010 Taylor et al.  
 7,854,325 B2 12/2010 Bentele  
 7,866,475 B2 1/2011 Doskoczynski et al.  
 D632,955 S \* 2/2011 Smith et al. .... D9/415  
 7,891,492 B2 2/2011 Wenninger et al.  
 D634,616 S 3/2011 Hansen et al.  
 D635,468 S 4/2011 Buitrago  
 D635,469 S 4/2011 Buitrago  
 7,919,171 B2 4/2011 Young  
 7,926,660 B2 4/2011 Jones et al.  
 7,931,148 B2 4/2011 Hansen et al.  
 D637,391 S 5/2011 Stevens et al.  
 7,934,355 B2 5/2011 Strub et al.  
 7,937,829 B2 5/2011 Petersen et al.  
 7,939,150 B2 5/2011 Altman et al.  
 7,950,390 B2 5/2011 Gumaste  
 7,959,004 B2 6/2011 Tsao  
 7,959,005 B2 6/2011 Berg et al.  
 7,963,089 B2 6/2011 Nelson et al.  
 D641,616 S 7/2011 Prevost  
 7,977,378 B1 7/2011 Villalobos  
 7,988,995 B1 8/2011 Bhalani et al.  
 8,091,704 B2 1/2012 Trigg

OTHER PUBLICATIONS

U.S. Office Action dated Mar. 25, 2013 issued in U.S. Appl. No. 29/416,880.  
 U.S. Office Action dated Apr. 1, 2013 issued in U.S. Appl. No. 29/429,017.  
 U.S. Office Action dated Oct. 3, 2012 issued in U.S. Appl. No. 29/416,879.  
 U.S. Office Action dated Jul. 15, 2013 issued in U.S. Appl. No. 13/432,247.  
 U.S. Office Action dated Jul. 18, 2013 issued in U.S. Appl. No. 29/429,016.  
 Invitation to Pay Additional Fees and, Where Applicable, Protest Fee mailed Jul. 10, 2013.

\* cited by examiner

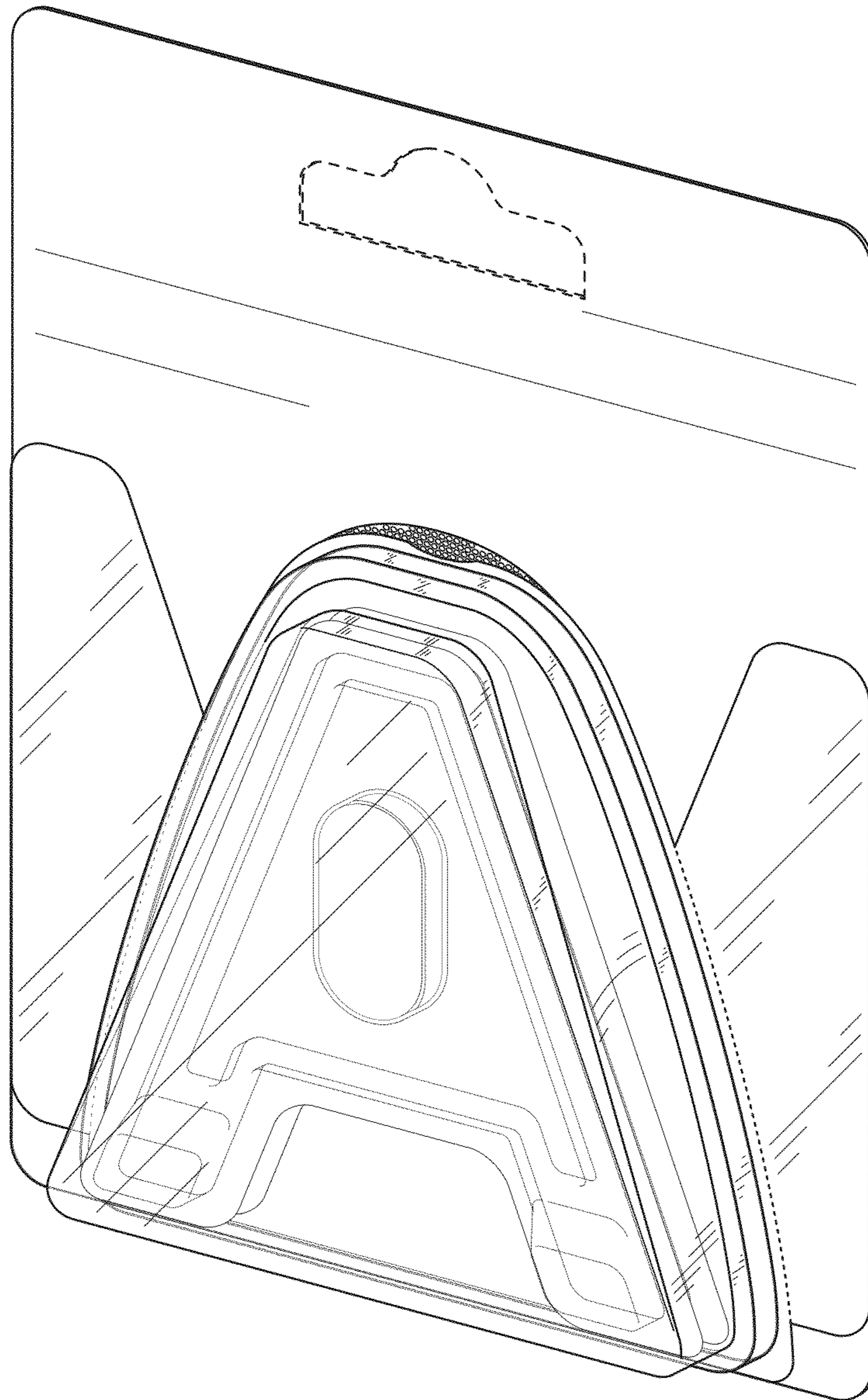

FIG. 1

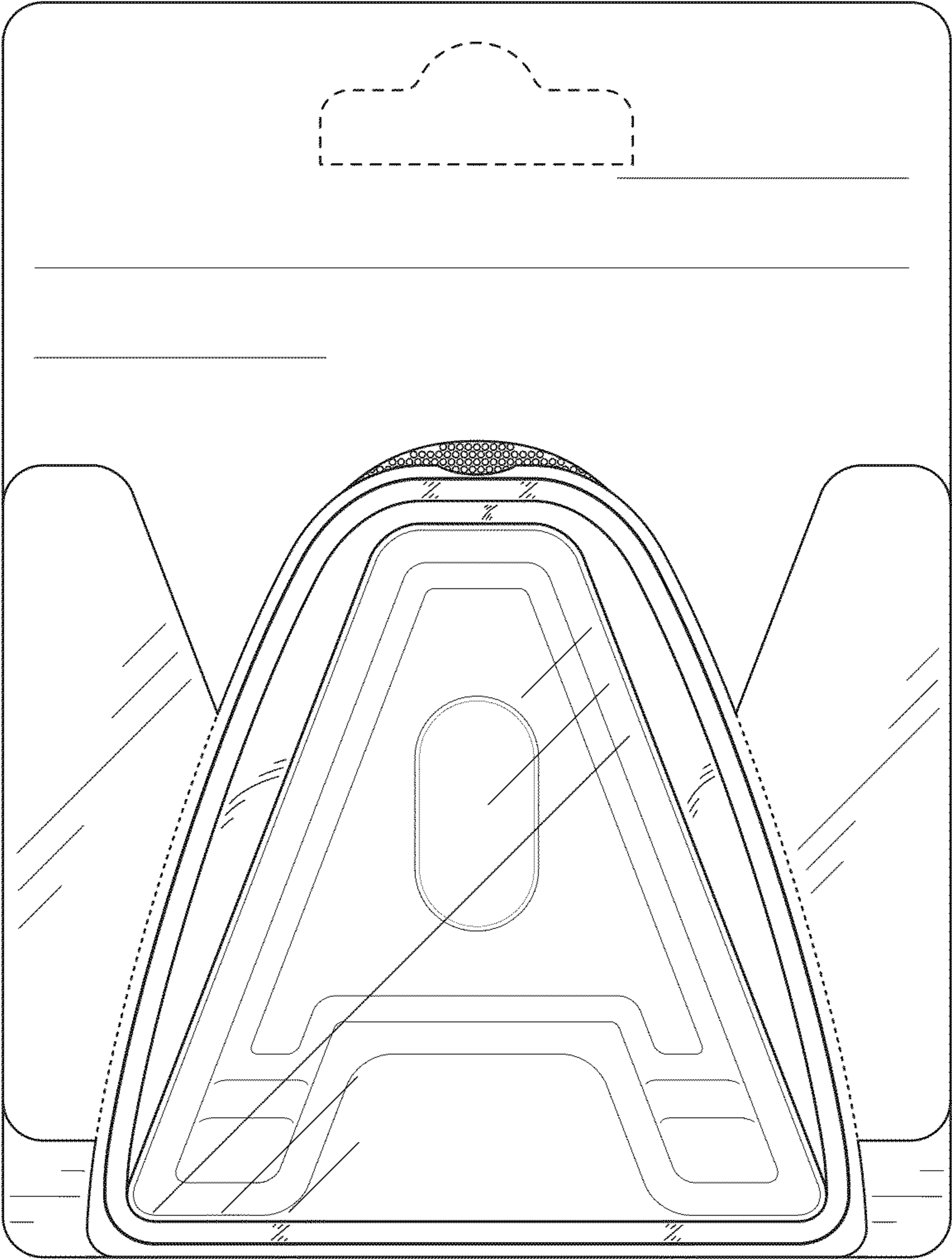

FIG. 2

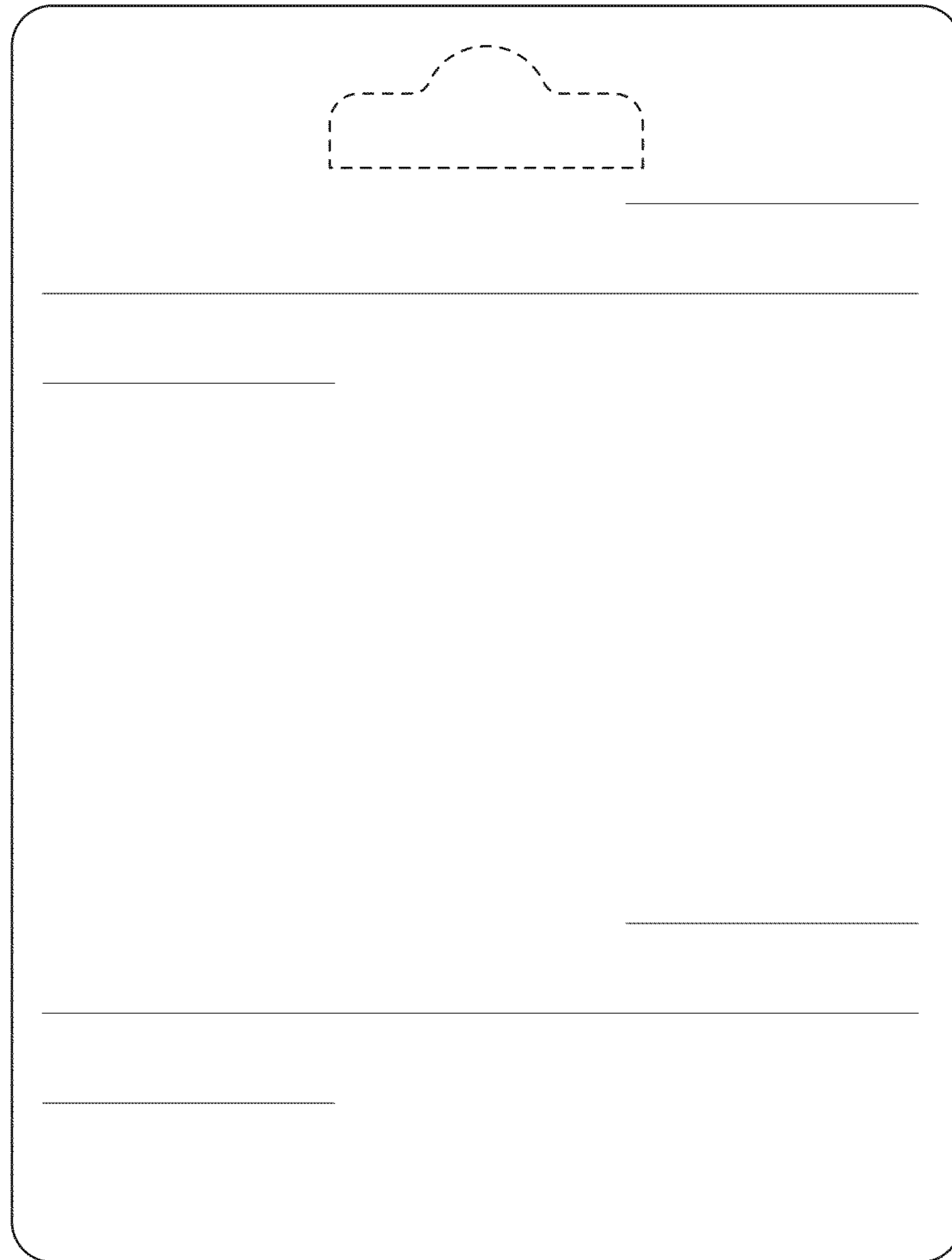

FIG. 3

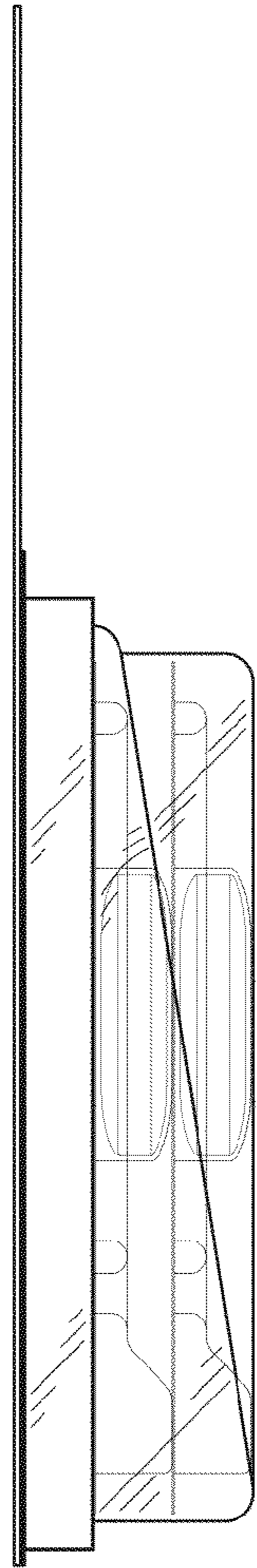

FIG. 4

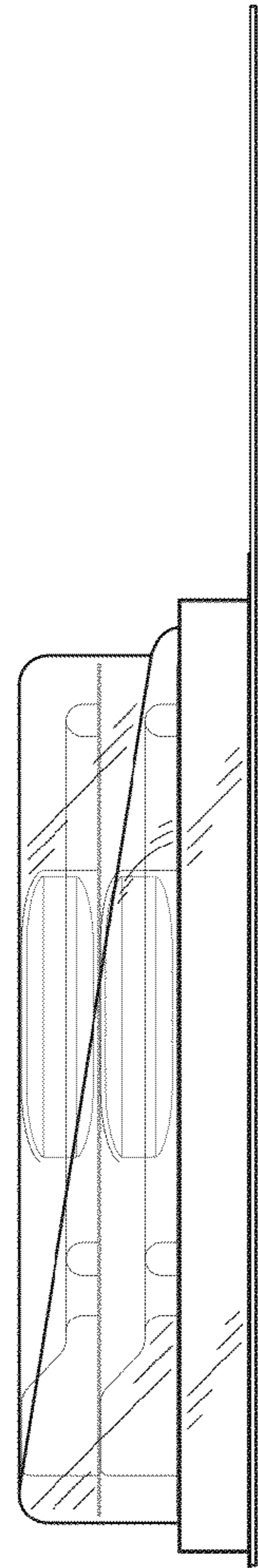

FIG. 5



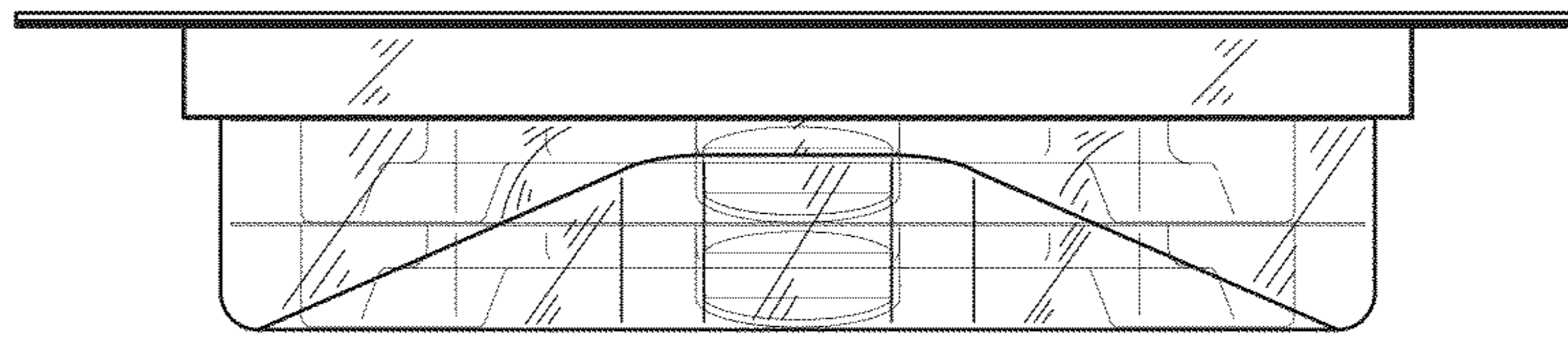

FIG. 6

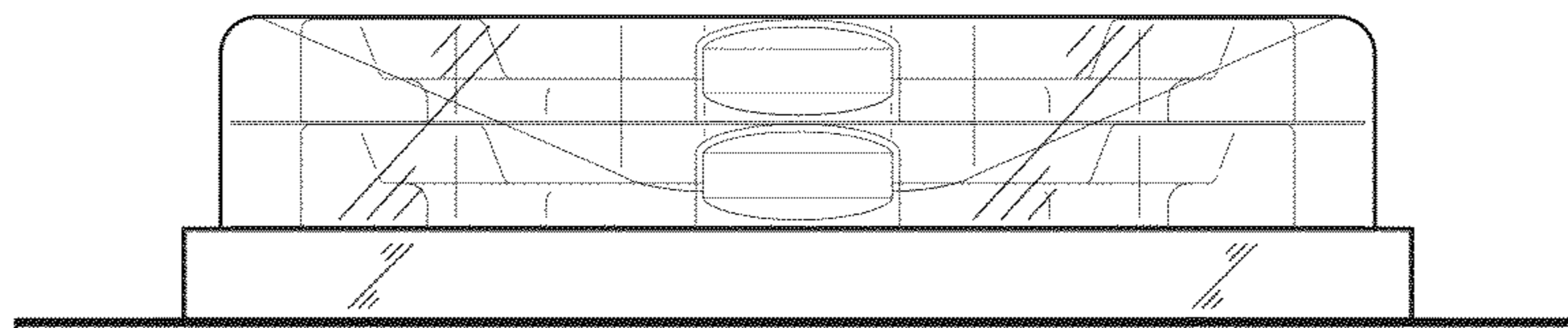

FIG. 7