



US00D693677S

(12) **United States Design Patent**
Pearson et al.

(10) **Patent No.:** **US D693,677 S**
(45) **Date of Patent:** **** Nov. 19, 2013**

(54) **FOOD CONTAINER**

(71) Applicant: **Union Packaging, LLC**, Yeadon, PA (US)

(72) Inventors: **Michael K. Pearson**, Philadelphia, PA (US); **Albert Jasper**, Glenolden, PA (US); **Joy Nash**, Harrisburg, PA (US); **Randall E. Carter**, Bear, DE (US)

(73) Assignee: **Union Packaging, LLC**, Yeadon, PA (US)

(**) Term: **14 Years**

(21) Appl. No.: **29/460,940**

(22) Filed: **Jul. 17, 2013**

Related U.S. Application Data

(62) Division of application No. 29/399,656, filed on Aug. 17, 2011, now Pat. No. Des. 688,939.

(51) **LOC (9) Cl.** **09-03**

(52) **U.S. Cl.**
USPC **D9/431**

(58) **Field of Classification Search**
USPC D9/414, 416, 418, 420-424, 430-433;
D3/272, 273, 302; 206/267, 269, 270,
206/273, 299, 737, 740, 822; 229/100, 101,
229/101.3, 106, 108-122

See application file for complete search history.

(56) **References Cited**

U.S. PATENT DOCUMENTS

1,135,742 A * 4/1915 Voris 229/117.14
2,336,655 A 12/1943 Tobey et al.
2,341,762 A 2/1944 Conklin
2,355,730 A 8/1944 Inman
2,805,813 A * 9/1957 Rittmueller 229/117.15
3,581,974 A * 6/1971 Freeman 229/110
D256,096 S 7/1980 Ganz

4,238,069 A 12/1980 Morris, Jr.
4,747,536 A * 5/1988 Wischusen, III 229/128
5,042,715 A * 8/1991 McNeill 229/117.15
5,392,984 A 2/1995 Yocum
D367,816 S * 3/1996 Cai D9/431
5,853,121 A 12/1998 Francisco
6,059,179 A * 5/2000 Giampapa 229/103
D442,859 S 5/2001 Hirschey
D467,798 S 12/2002 Cohon
D576,482 S 9/2008 DeBusk
D688,939 S * 9/2013 Pearson et al. D9/431

* cited by examiner

Primary Examiner — Susan Bennett Hattan

Assistant Examiner — Vy Koenig

(74) *Attorney, Agent, or Firm* — Jason F. Cotter; Archer & Greiner, P.C.

(57) **CLAIM**

The ornamental design for a food container, as shown and described.

DESCRIPTION

FIG. 1 is a front perspective view of a food container showing our new design;
FIG. 2 is a front elevational view of a food container showing our new design;
FIG. 3 is a rear elevational view of a food container showing our new design;
FIG. 4 is a top plan view of a food container showing our new design;
FIG. 5 is a bottom plan view of a food container showing our new design;
FIG. 6 is a left side elevational view of a food container showing our new design; and,
FIG. 7 is a right side elevational view of a food container showing our new design.
The broken lines shown in the drawings represent unclaimed portions of the food container and form no part of the claimed design.

1 Claim, 4 Drawing Sheets

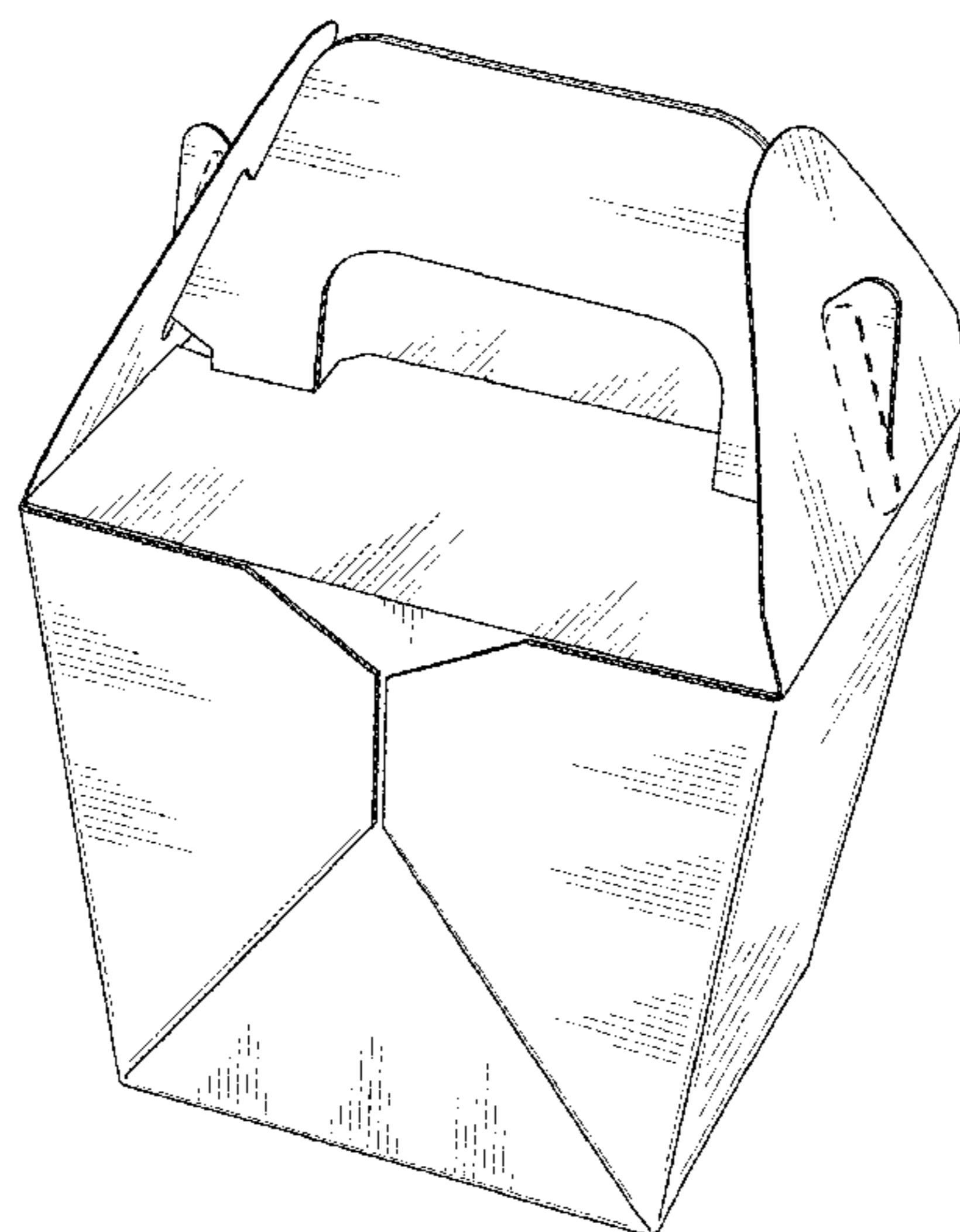

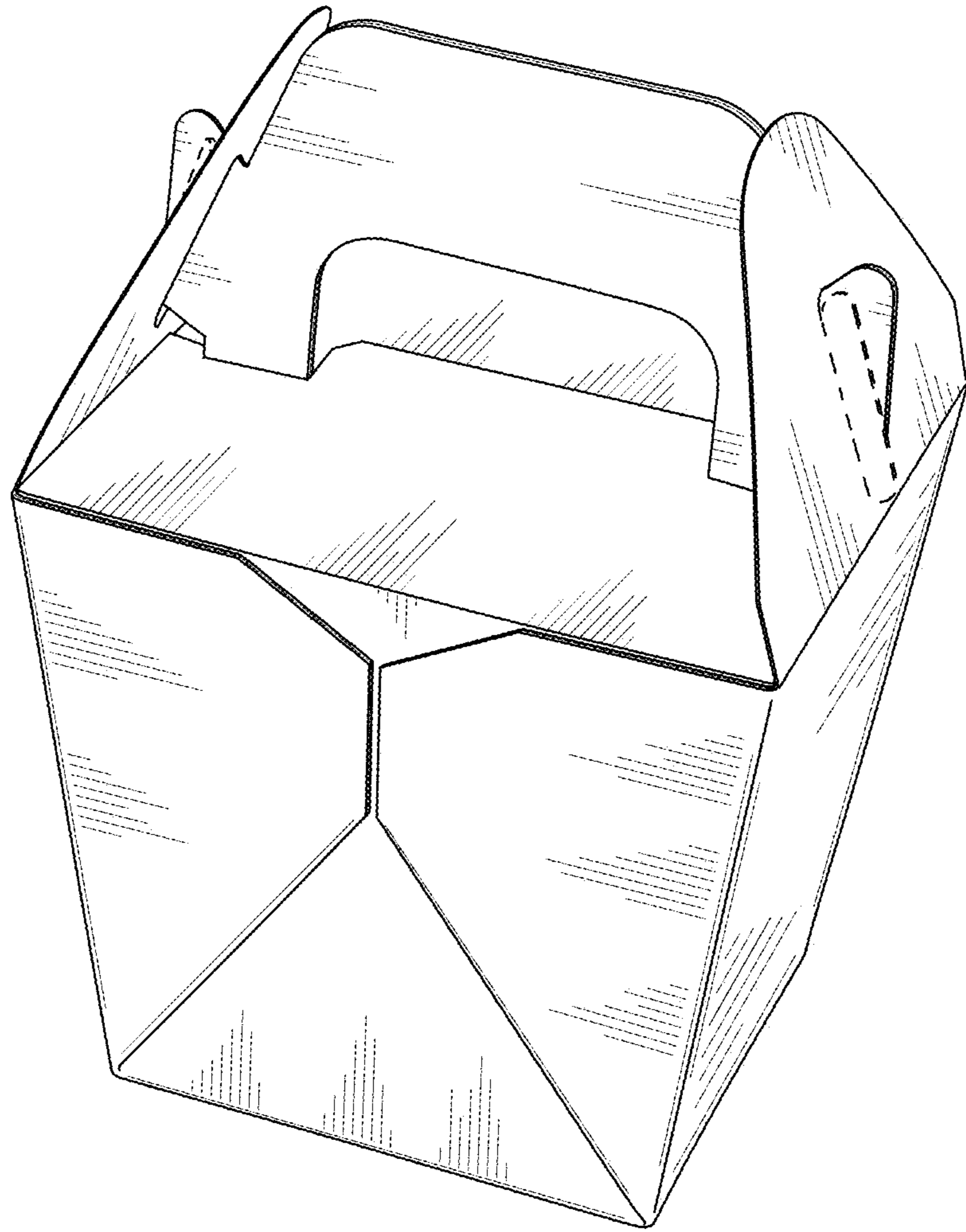

FIG. 1

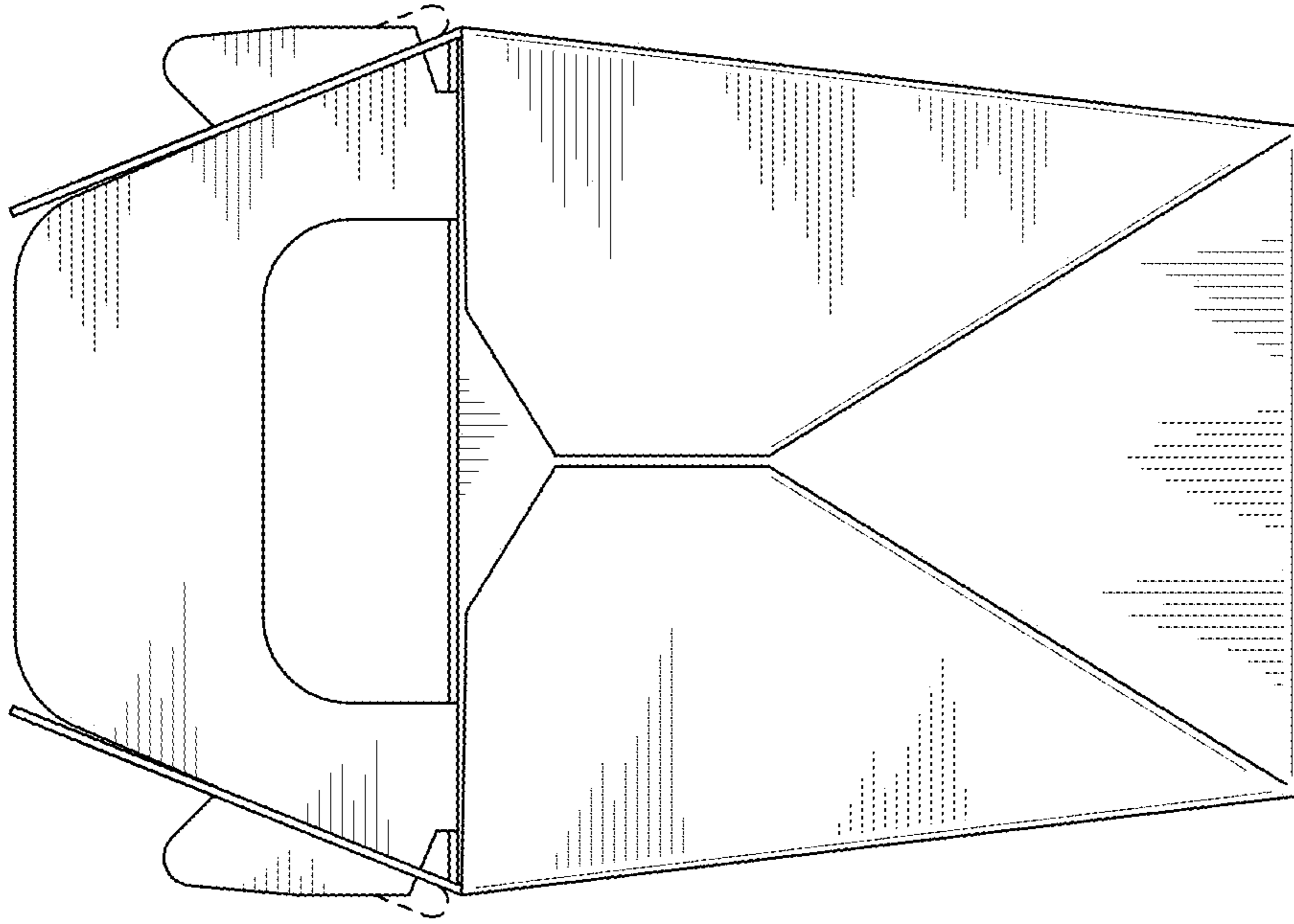

FIG. 2

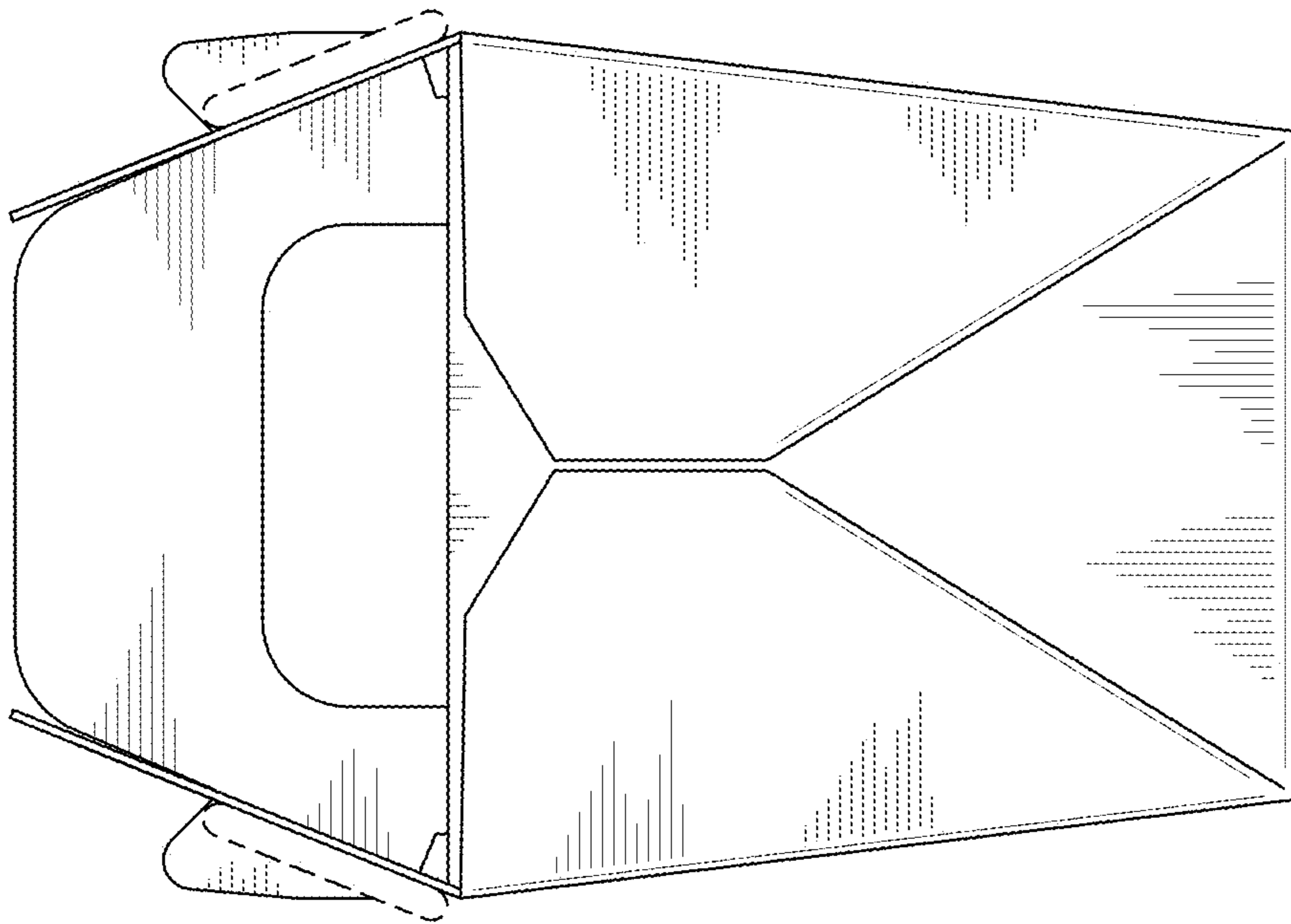

FIG. 3

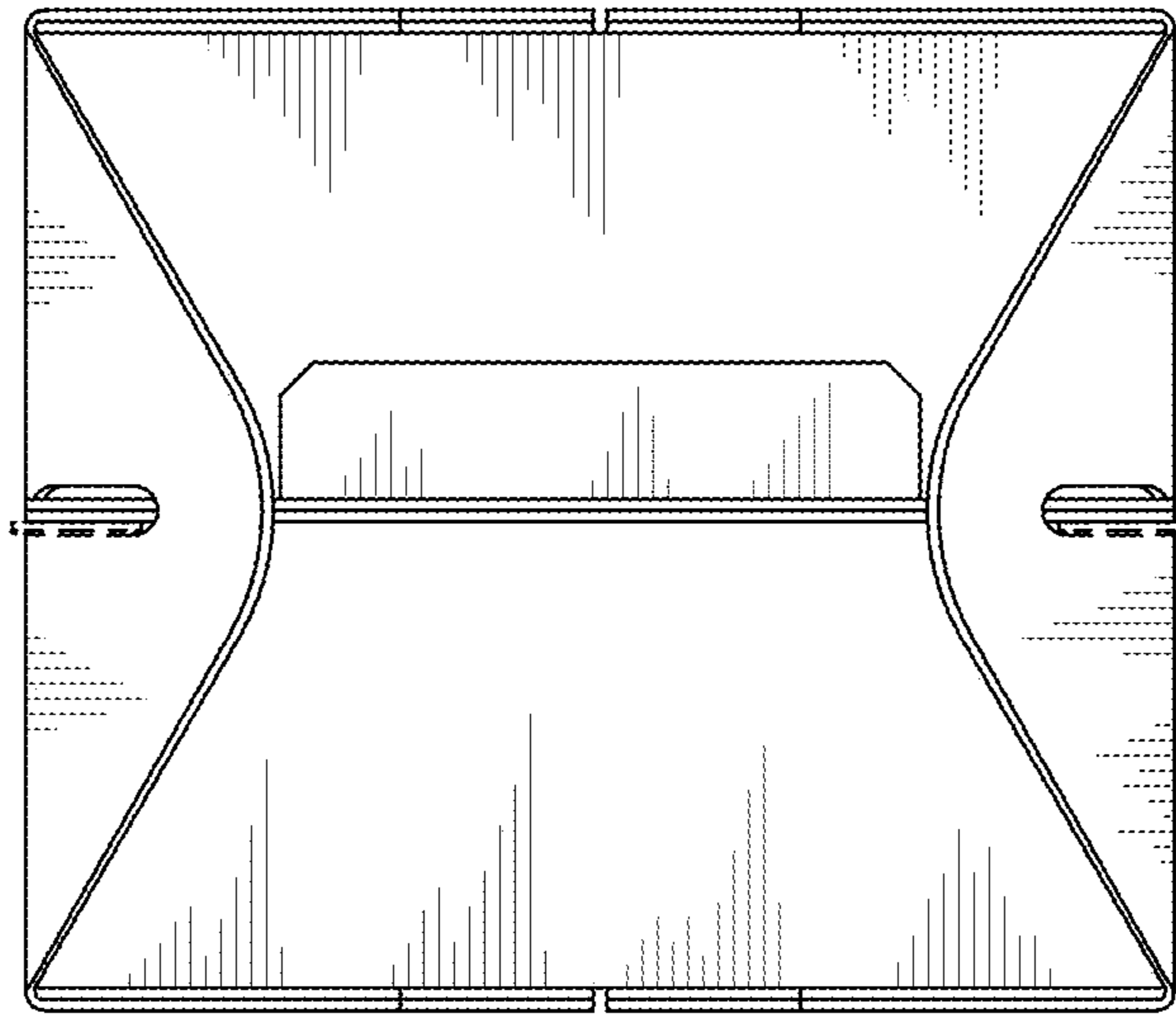

FIG. 4

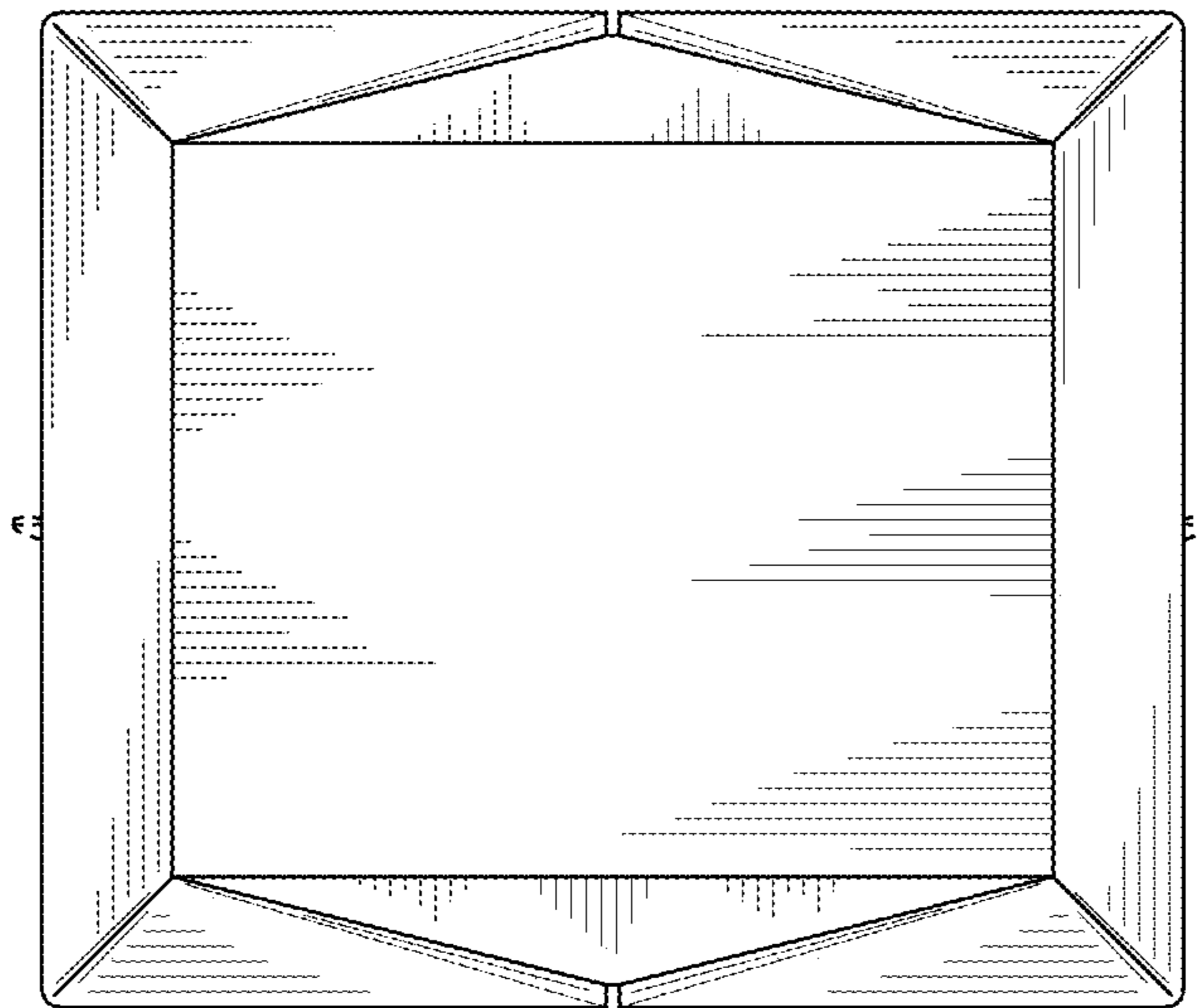

FIG. 5

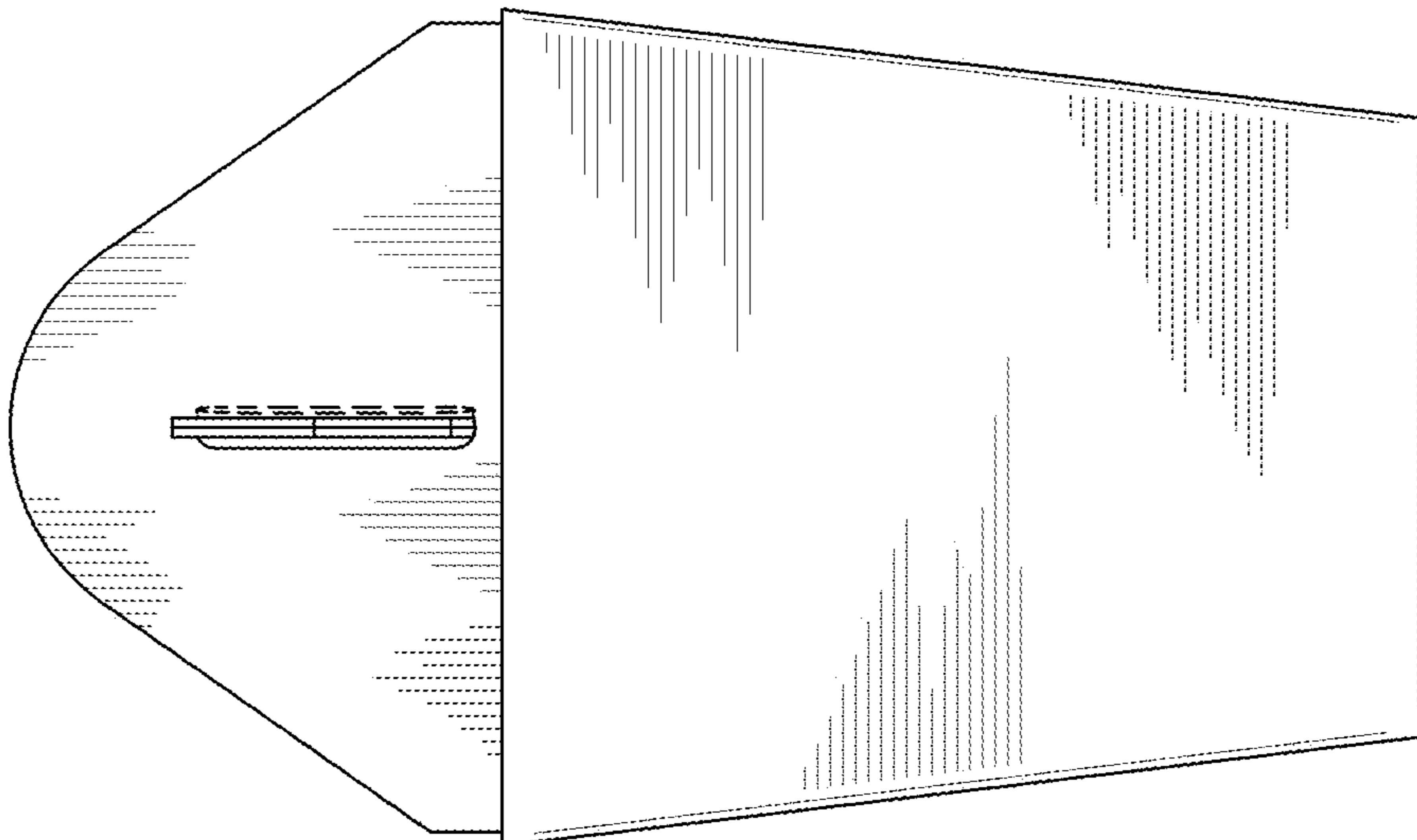

FIG. 6

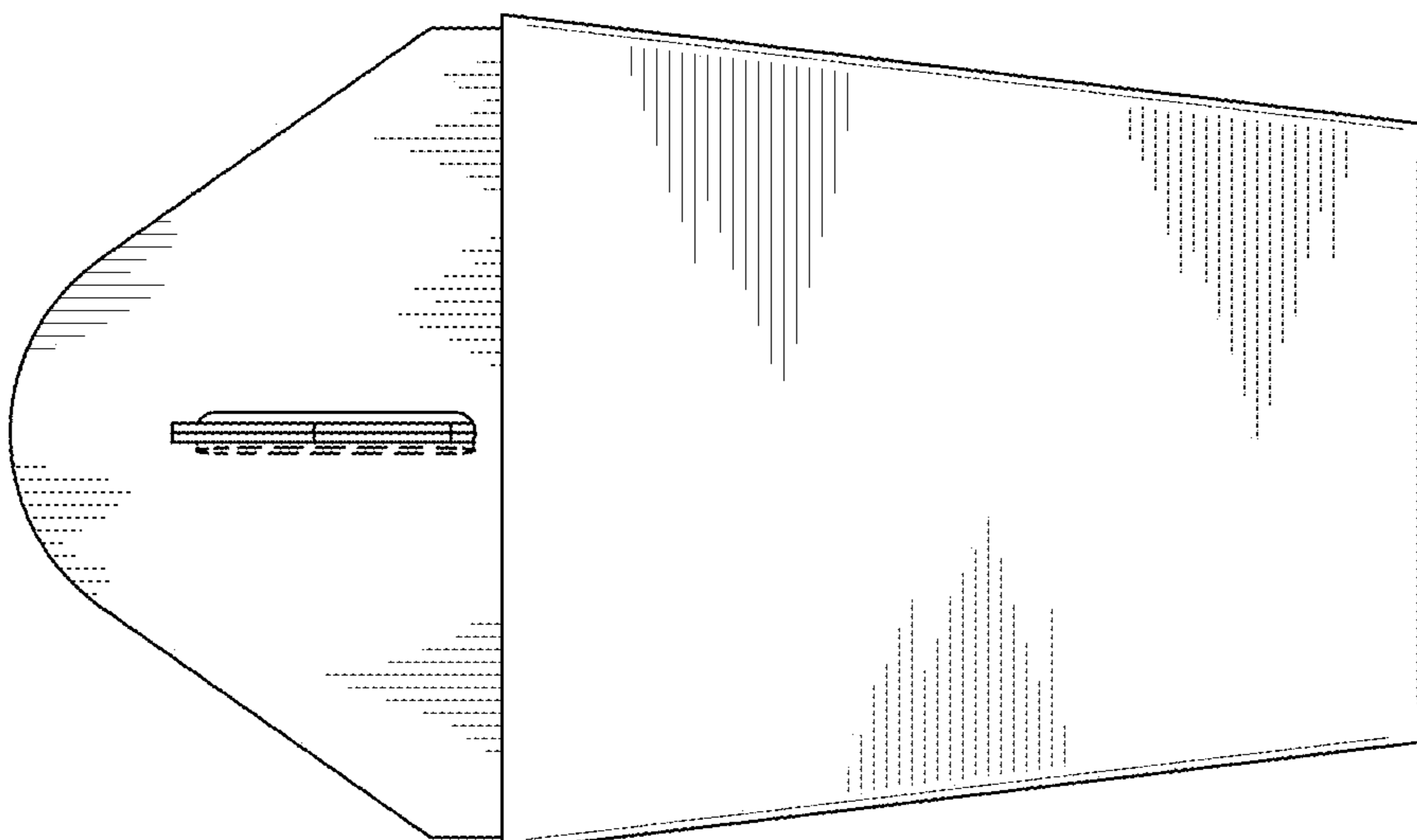

FIG. 7