

US00D693623S

(12) **United States Design Patent**
Merkurieff

(10) **Patent No.:** **US D693,623 S**
(45) **Date of Patent:** **** Nov. 19, 2013**

- (54) **COLLAPSIBLE CAMP STOVE**
- (71) Applicant: **Merkwares, LLC**, Eagle Mountain, UT (US)
- (72) Inventor: **Mikhail E. Merkurieff**, Eagle Mountain, UT (US)
- (73) Assignee: **Merkwares, LLC**, Eagle Mountain, UT (US)
- (**) Term: **14 Years**
- (21) Appl. No.: **29/451,615**
- (22) Filed: **Apr. 4, 2013**

Related U.S. Application Data

- (63) Continuation of application No. 29/404,287, filed on Oct. 18, 2011, now Pat. No. Des. 682,006.
- (51) **LOC (9) Cl.** **07-02**
- (52) **U.S. Cl.**
USPC **D7/332**
- (58) **Field of Classification Search**
USPC D7/332, 334, 337, 402-406, 409;
126/27, 44, 25 R, 41 R, 9 R, 40, 50, 38,
126/39 H, 39 N, 39 K, 39 M, 39 R, 39 J, 39 G,
126/39 E, 285 R, 287, 290, 80, 243; 99/425,
99/444-44, 450, 481, 482, 340; 431/247,
431/207, 264
See application file for complete search history.

(56) **References Cited**

U.S. PATENT DOCUMENTS

3,384,066	A *	5/1968	Tufts	126/9 R
4,455,992	A *	6/1984	Hsiao	126/9 R
4,508,094	A *	4/1985	Hait	126/9 R
4,794,906	A *	1/1989	Longley, Jr.	126/9 R
5,711,210	A *	1/1998	Kaufman	99/340

D546,114	S *	7/2007	Reiner	D7/332
8,028,689	B2 *	10/2011	Bruno	126/25 R
2005/0115556	A1 *	6/2005	Carson et al.	126/25 R
2007/0006863	A1 *	1/2007	Barbarich	126/9 R
2011/0146656	A1 *	6/2011	Paap et al.	126/25 R
2012/0073570	A1 *	3/2012	Wall et al.	126/9 R
2012/0260904	A1 *	10/2012	Russell	126/25 R

OTHER PUBLICATIONS

“Neufeld MK1 Woodburning Stove”, West Coast Paddler, posted May 3, 2007, accessed Sep. 23, 2013. URL: <http://www.westcoastpaddler.com/community/viewtopic.php?t=1041>.
 “Twig Stove”, BushcraftUSA, posted Feb. 25, 2011, accessed Sep. 23, 2013. URL: <http://bushcraftusa.com/forum/showthread.php/30750-Twig-Stove>.
 “Nimblewill Stove Pics and Mods”, BushcraftUSA, posted Nov. 22, 2010, accessed Sep. 23, 2013. URL: <http://bushcraftusa.com/forum/showthread.php/23347-Nimblewill-Stove-Pics-and-Mods/page2>.

* cited by examiner

Primary Examiner — Ruth McInroy

(74) *Attorney, Agent, or Firm* — Keller Jolley Preece

(57) **CLAIM**

The ornamental design for a collapsible camp stove, as shown and described.

DESCRIPTION

FIG. 1 is a perspective view of a collapsible camp stove showing the new design;
 FIG. 2 is a front elevational view thereof;
 FIG. 3 is a rear elevational view thereof;
 FIG. 4 is a right side elevational view thereof;
 FIG. 5 is a left side elevational view thereof;
 FIG. 6 is a top plan view thereof; and,
 FIG. 7 is a bottom plan view thereof.
 The broken lines are for illustrative purposes only and form no part of the claimed design.

1 Claim, 7 Drawing Sheets

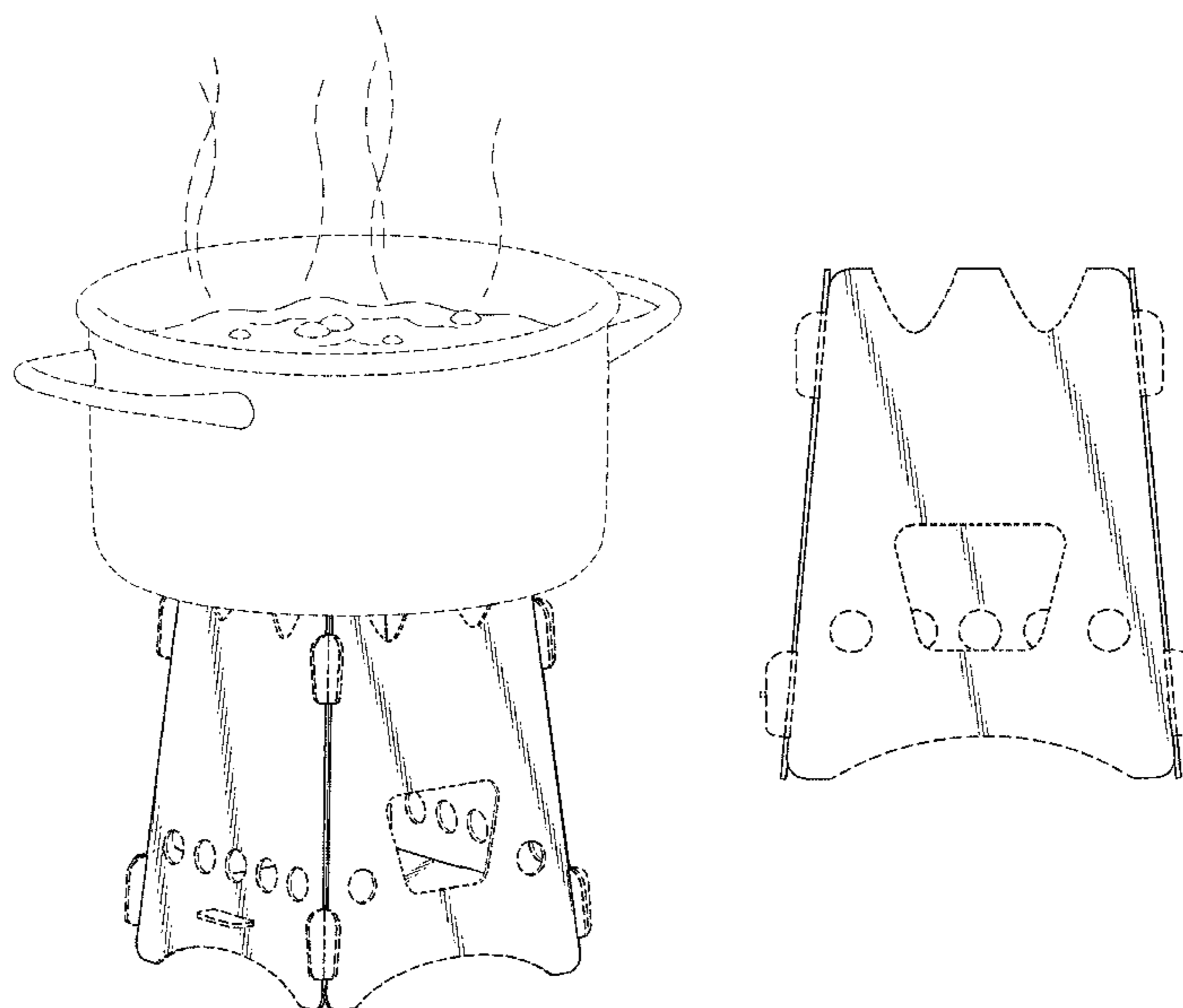

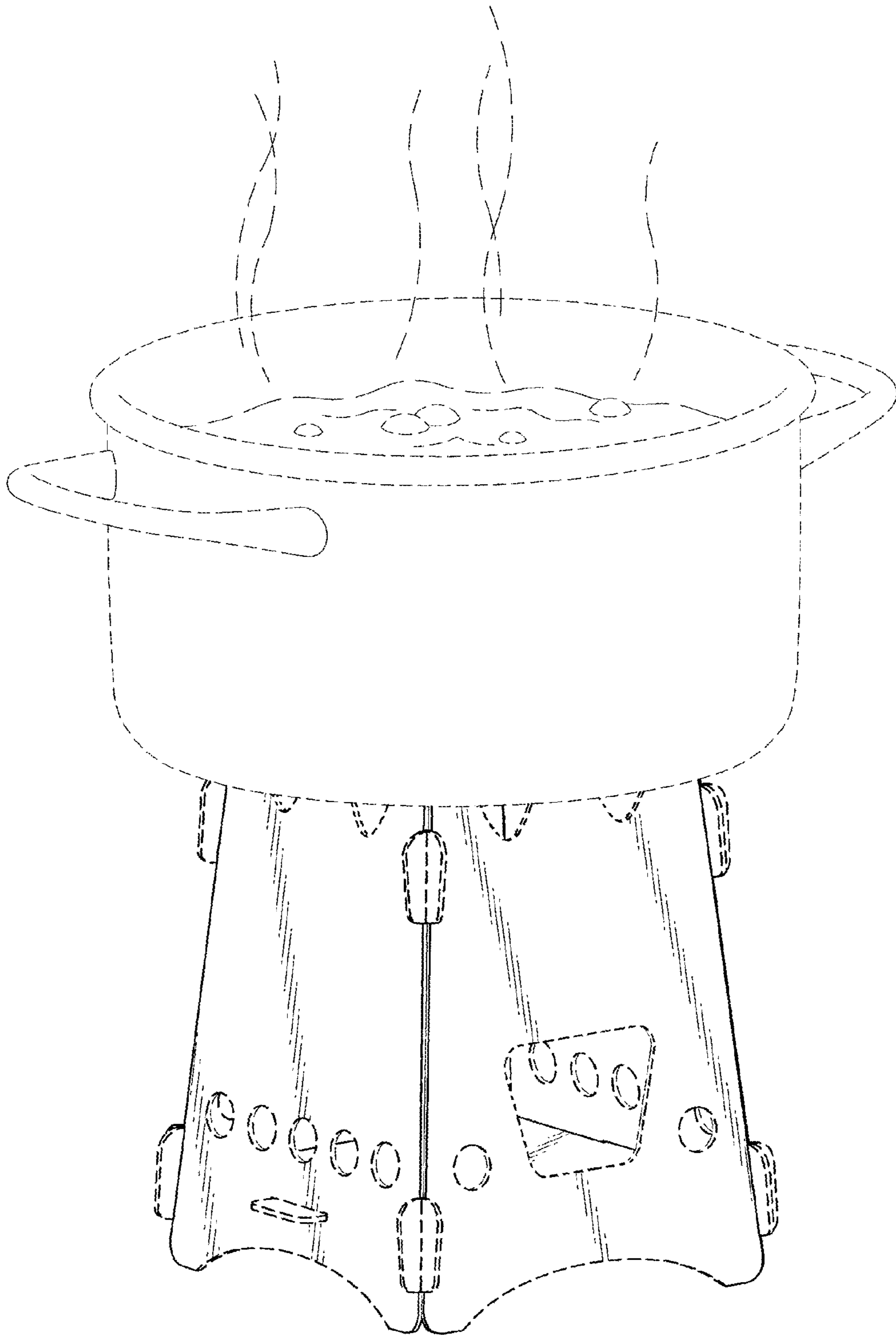

Fig. 1

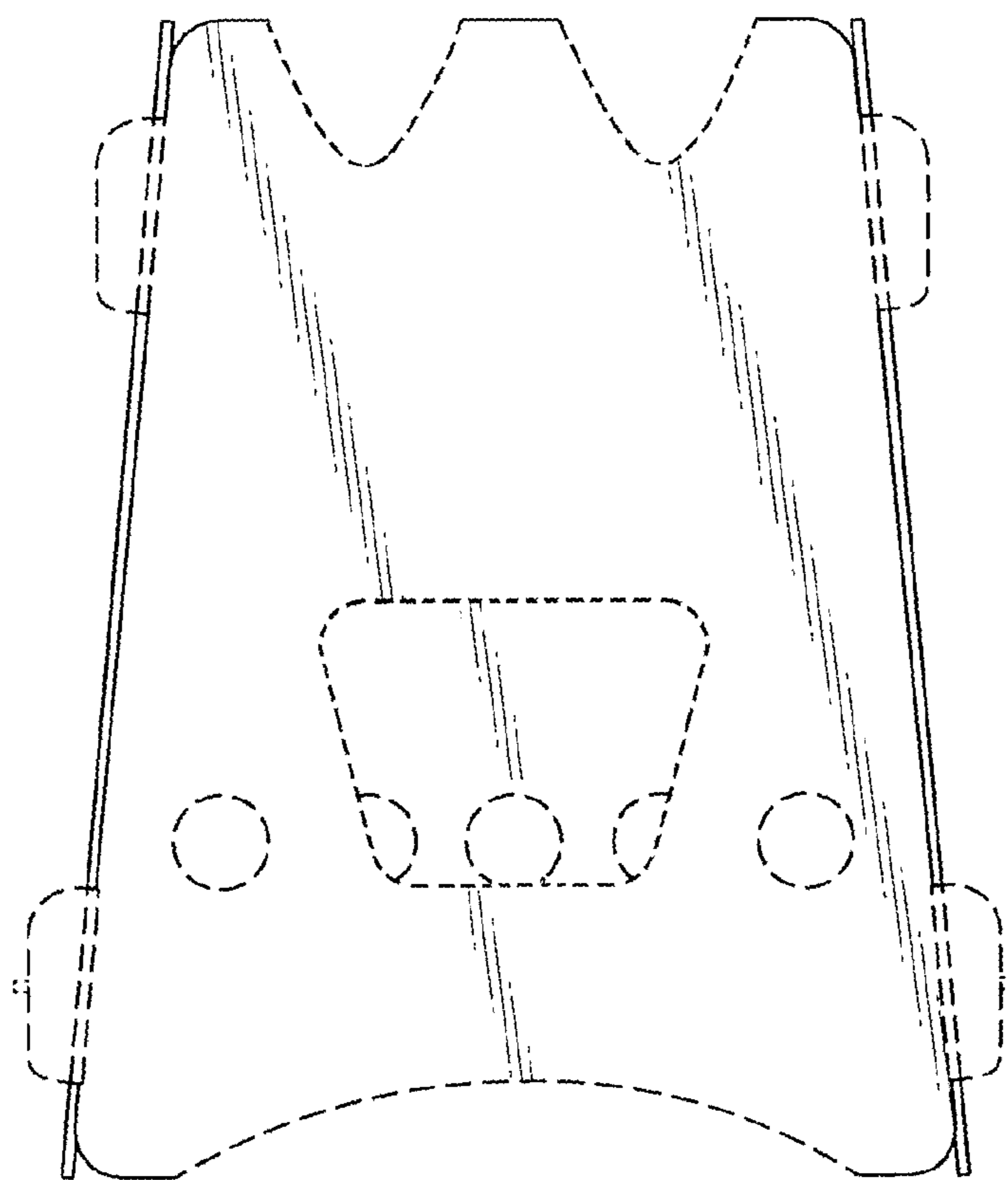

Fig. 2

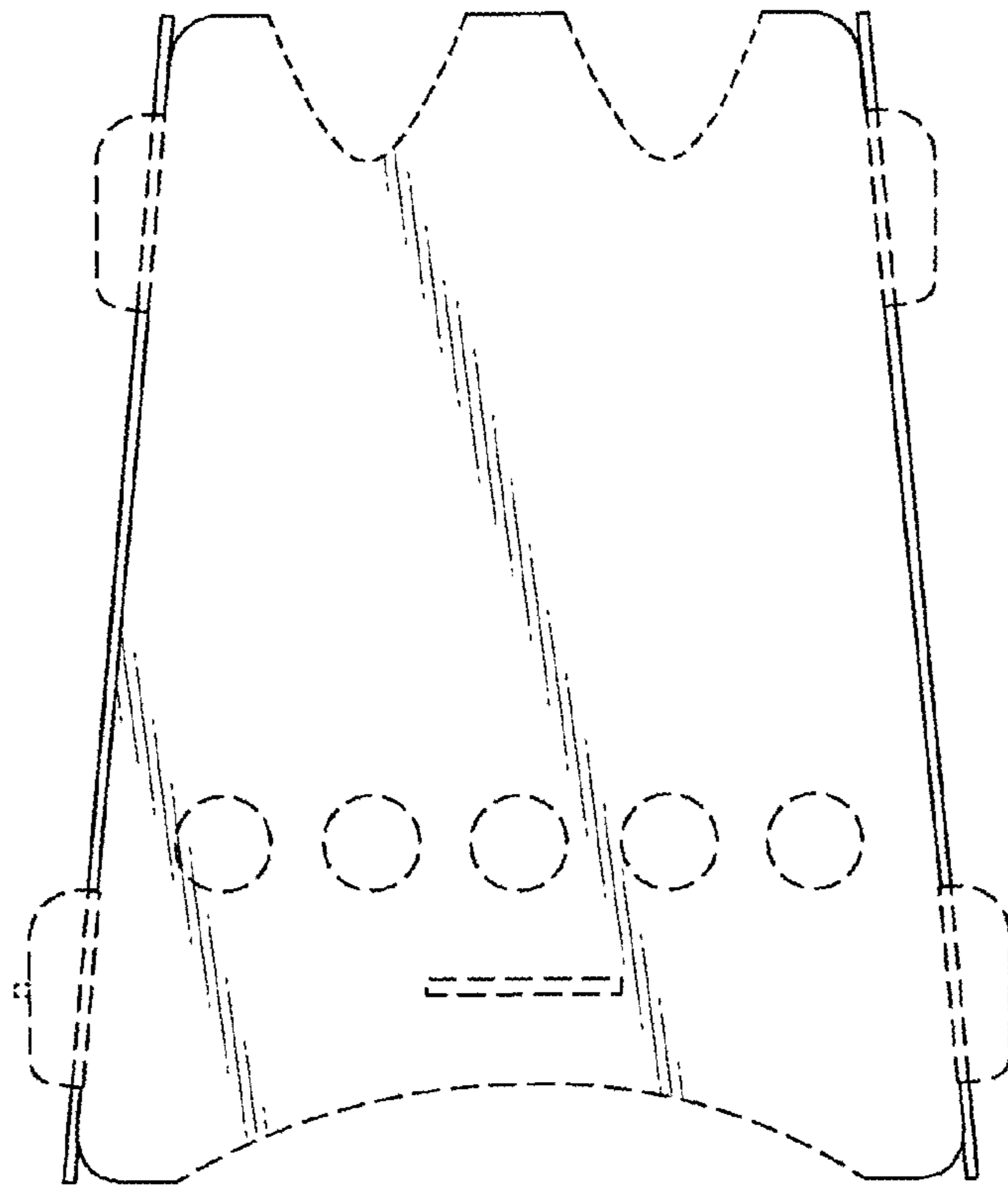

Fig. 3

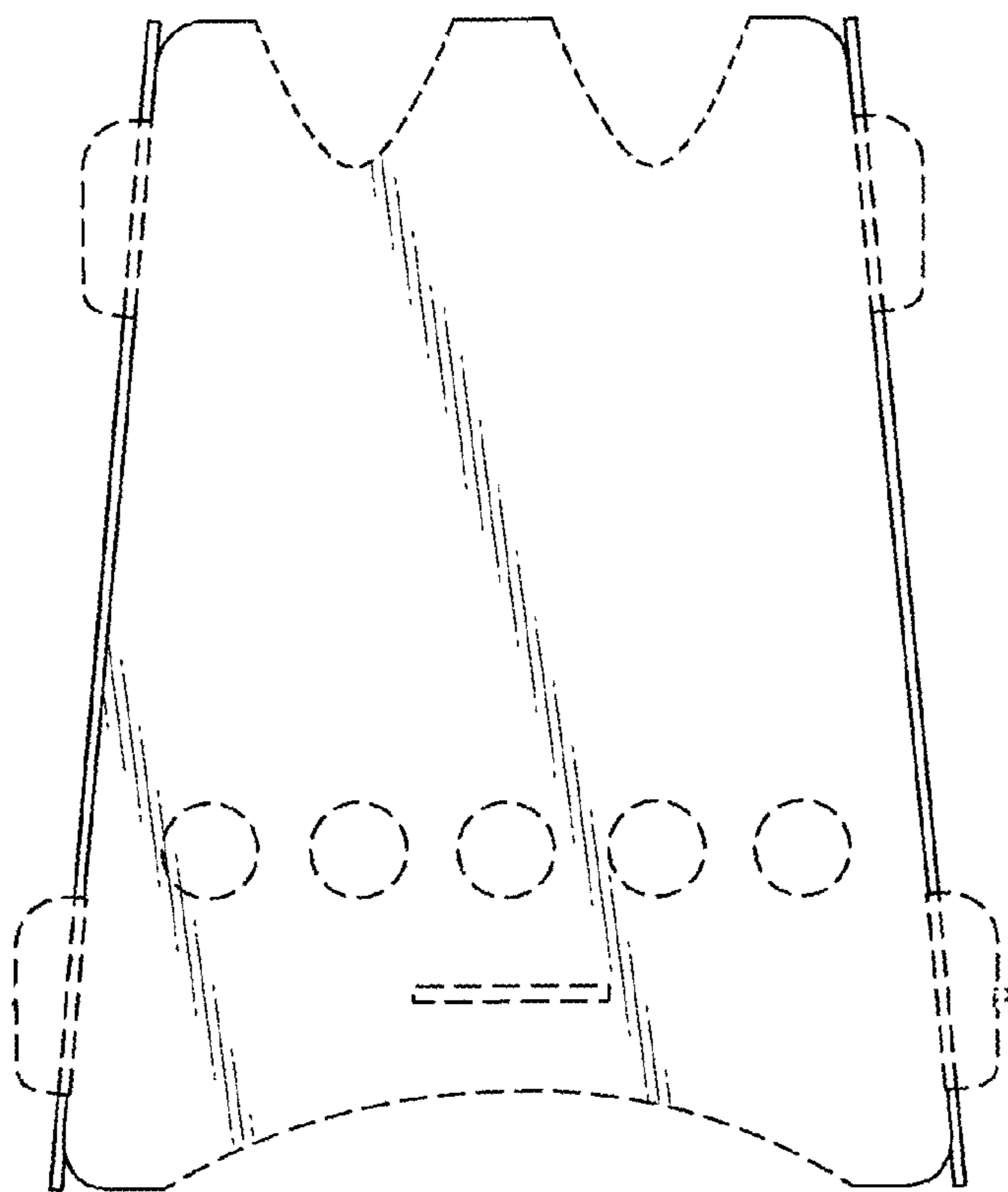

Fig. 4

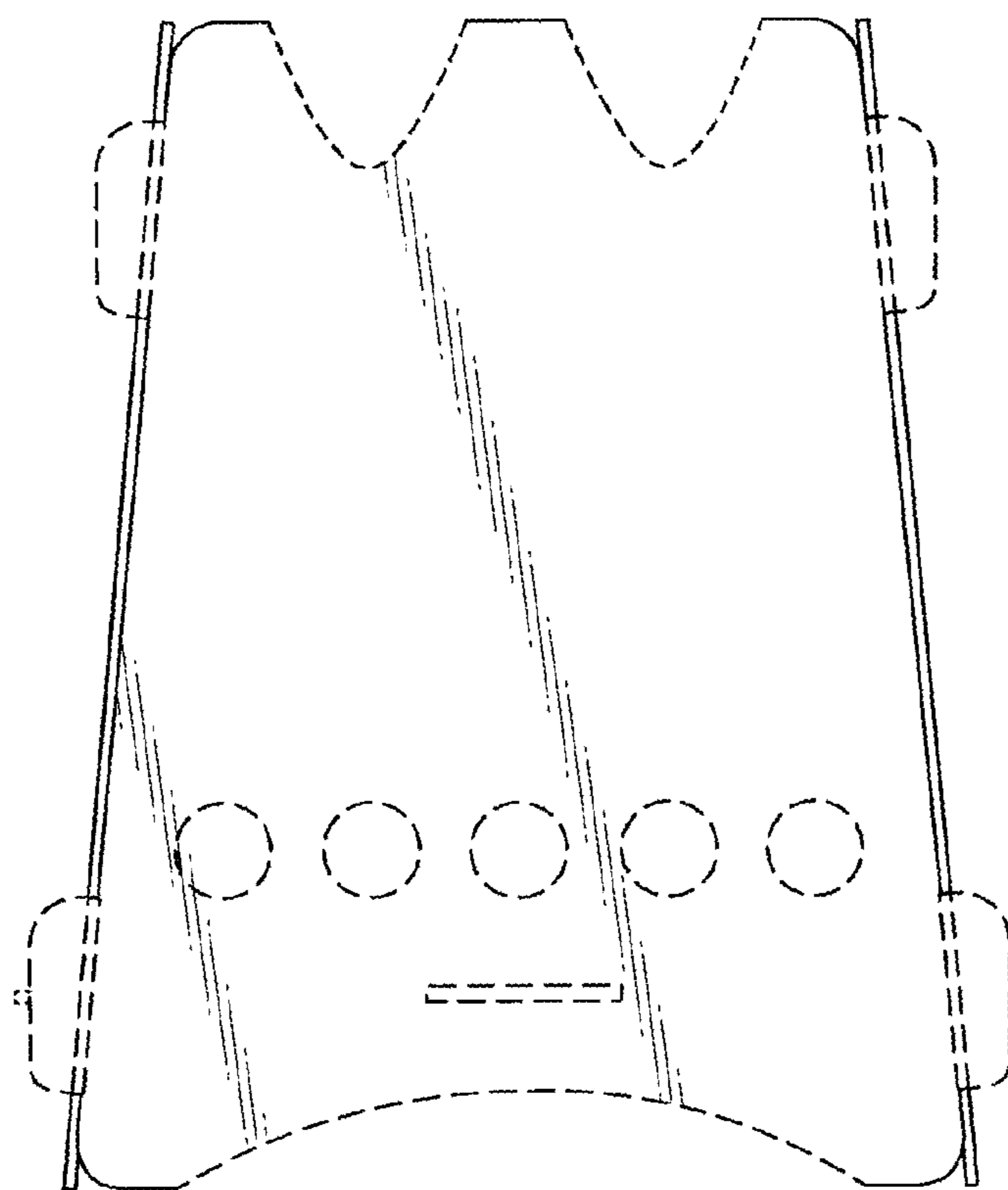

Fig. 5

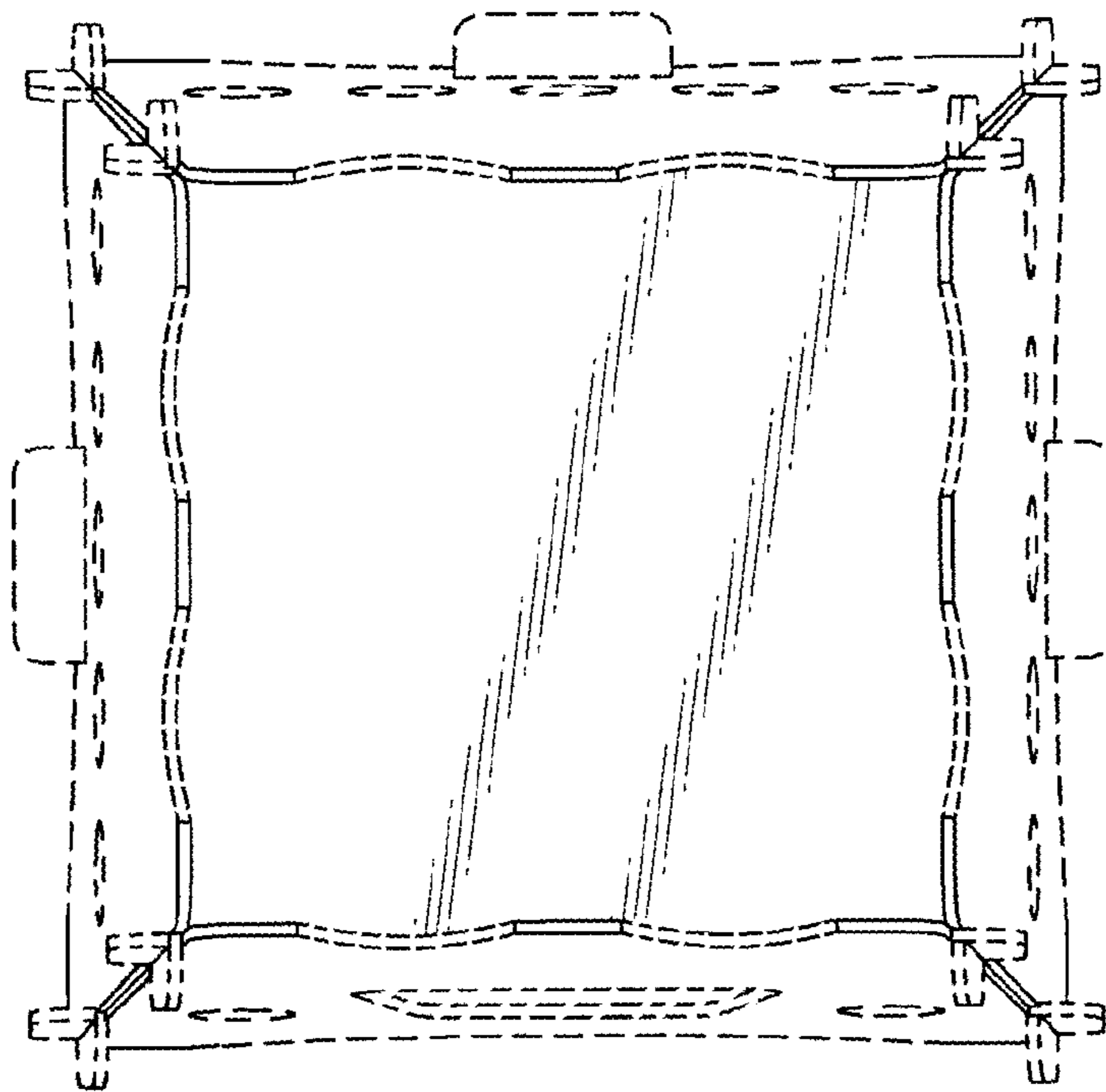

Fig. 6

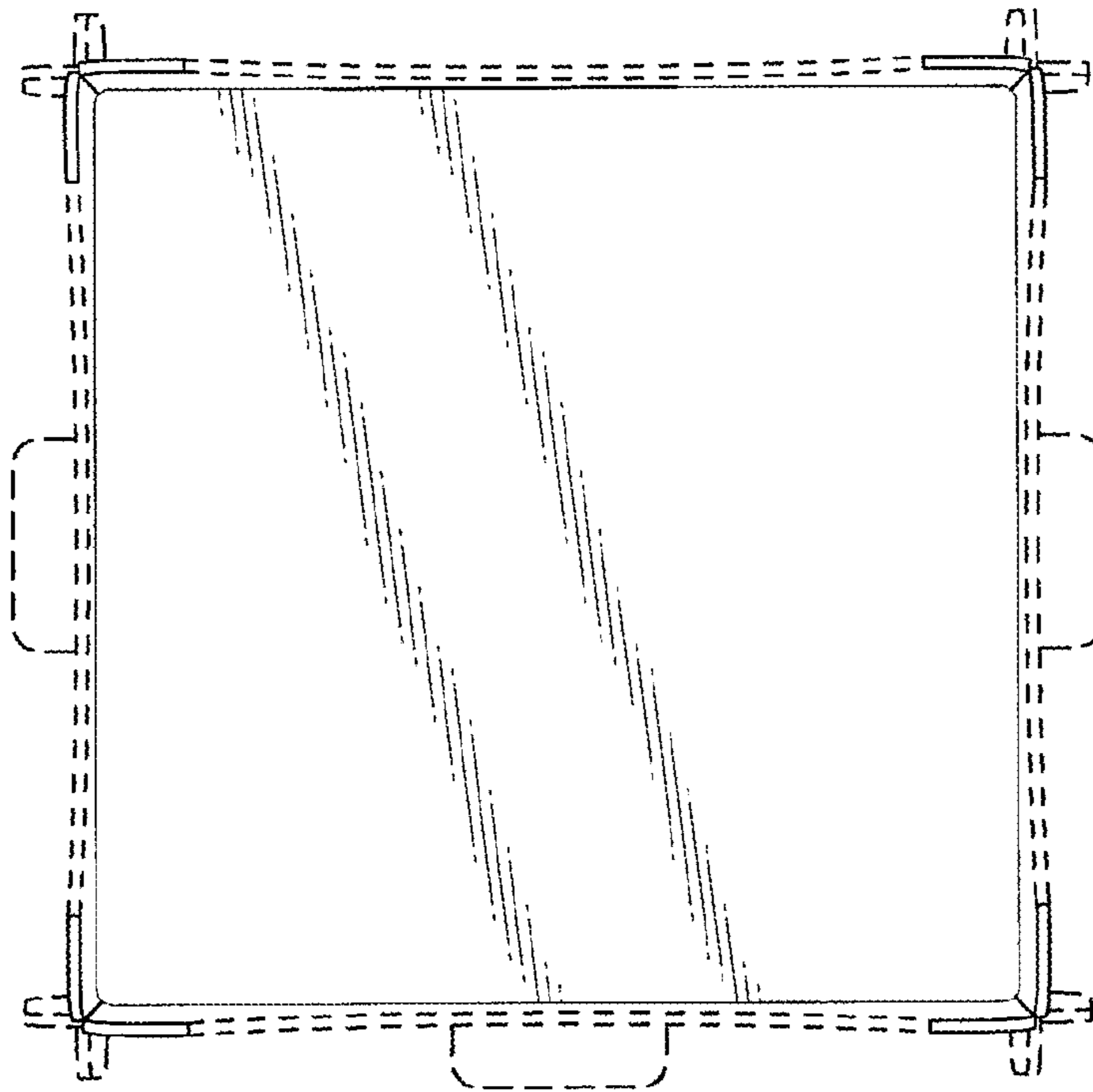

Fig. 7