



US00D693534S

(12) **United States Design Patent**
Hooke, III et al.

(10) **Patent No.:** **US D693,534 S**

(45) **Date of Patent:** **** Nov. 12, 2013**

(54) **PET MEMORIAL PLANTER**

(76) Inventors: **G. Draycott Hooke, III**, Canadensis, PA (US); **Edgar John Hartman, Jr.**, Swoyersville, PA (US)

(**) Term: **14 Years**

(21) Appl. No.: **29/419,307**

(22) Filed: **Apr. 26, 2012**

Related U.S. Application Data

(63) Continuation-in-part of application No. 29/408,875, filed on Dec. 16, 2011, now Pat. No. Des. 681,905.

(51) **LOC (9) Cl.** **25-03**

(52) **U.S. Cl.**
USPC **D99/20**; D99/17

(58) **Field of Classification Search**
USPC D99/20, 1, 8, 17, 18, 19, 99; 52/103, 52/104; 47/33, 32.4, 32.5, 23.2, 25.1; D11/130, 143, 145, 155, 164; D7/354, D7/350.2, 409; 249/66.1; 220/23.2, 4.17, 220/23.4, 23.6, 23.8, 912, 376, 629; D6/403
See application file for complete search history.

(56) **References Cited**

U.S. PATENT DOCUMENTS

425,890 A * 4/1890 Landis 47/33
992,529 A * 5/1911 Abraham 47/19.1
1,217,291 A * 2/1917 Farrington 220/610

1,552,856 A * 9/1925 Judge 220/8
1,851,710 A * 3/1932 Lefevre 52/102
2,146,784 A * 2/1939 Wilson 47/33
2,891,352 A * 6/1959 Altman 47/19.1
2,909,328 A * 10/1959 Babyak 239/268
2,951,606 A * 9/1960 Benson 217/65
3,315,752 A * 4/1967 Pasquini 172/19
3,396,488 A * 8/1968 Ries 47/33
D651,121 S * 12/2011 Grimme D11/155
D681,905 S * 5/2013 Hartman D99/20

* cited by examiner

Primary Examiner — Paula Greene

(74) *Attorney, Agent, or Firm* — QuickPatents; Kevin Prince

(57) **CLAIM**

We claim the ornamental design for a pet memorial planter, as shown and described.

DESCRIPTION

FIG. 1 is a perspective view of a pet memorial planter, showing our new design;
FIG. 2 is a front elevational view thereof;
FIG. 3 is a rear elevational view thereof;
FIG. 4 is a right-side elevational view thereof, the left-side elevational view being a mirror image thereof;
FIG. 5 is a top plan view thereof; and,
FIG. 6 is a bottom plan view thereof.
The broken lines showing text and ground spikes in the figures depict environmental matter, and form no part of the claimed design.

1 Claim, 3 Drawing Sheets

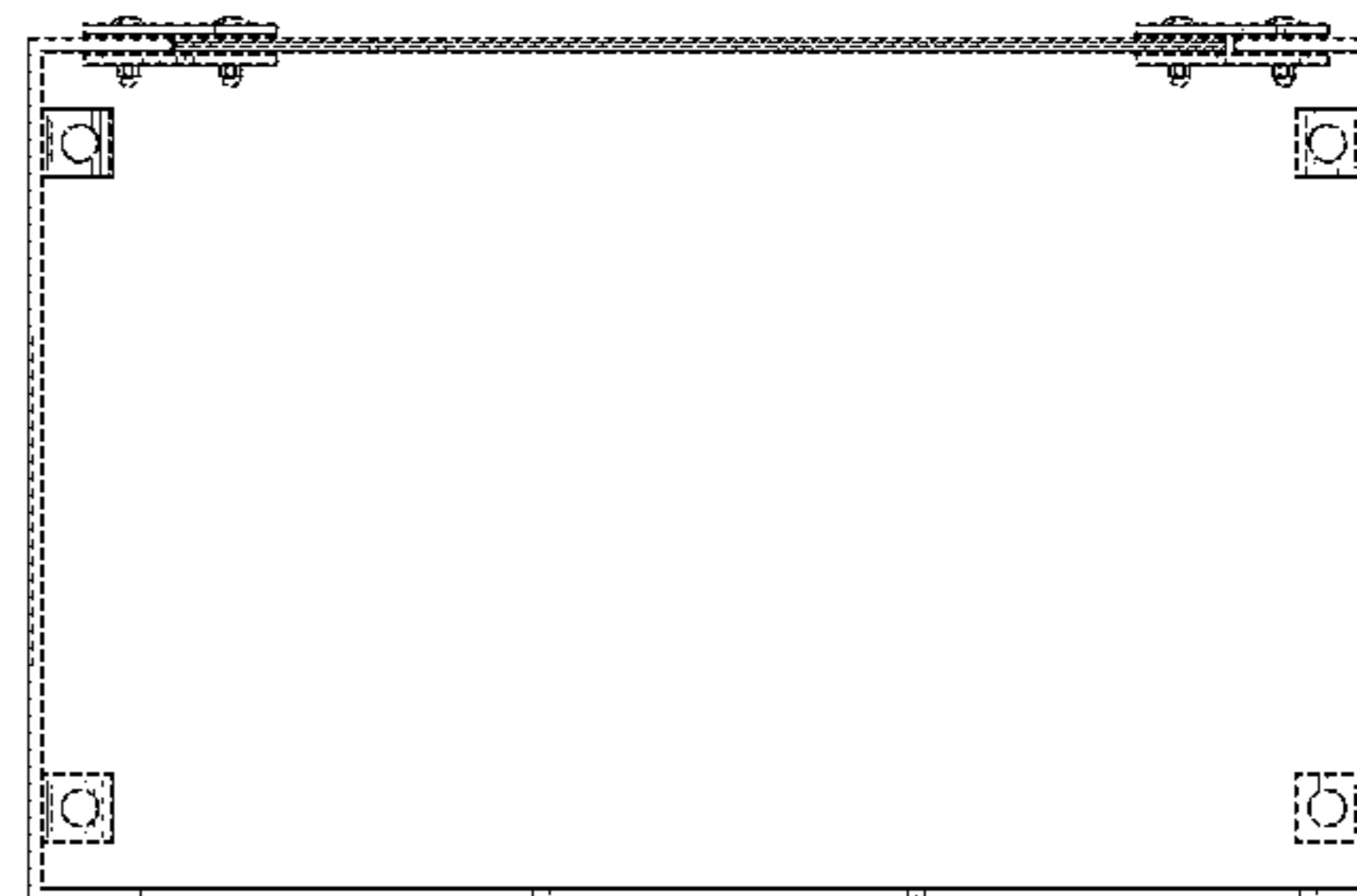
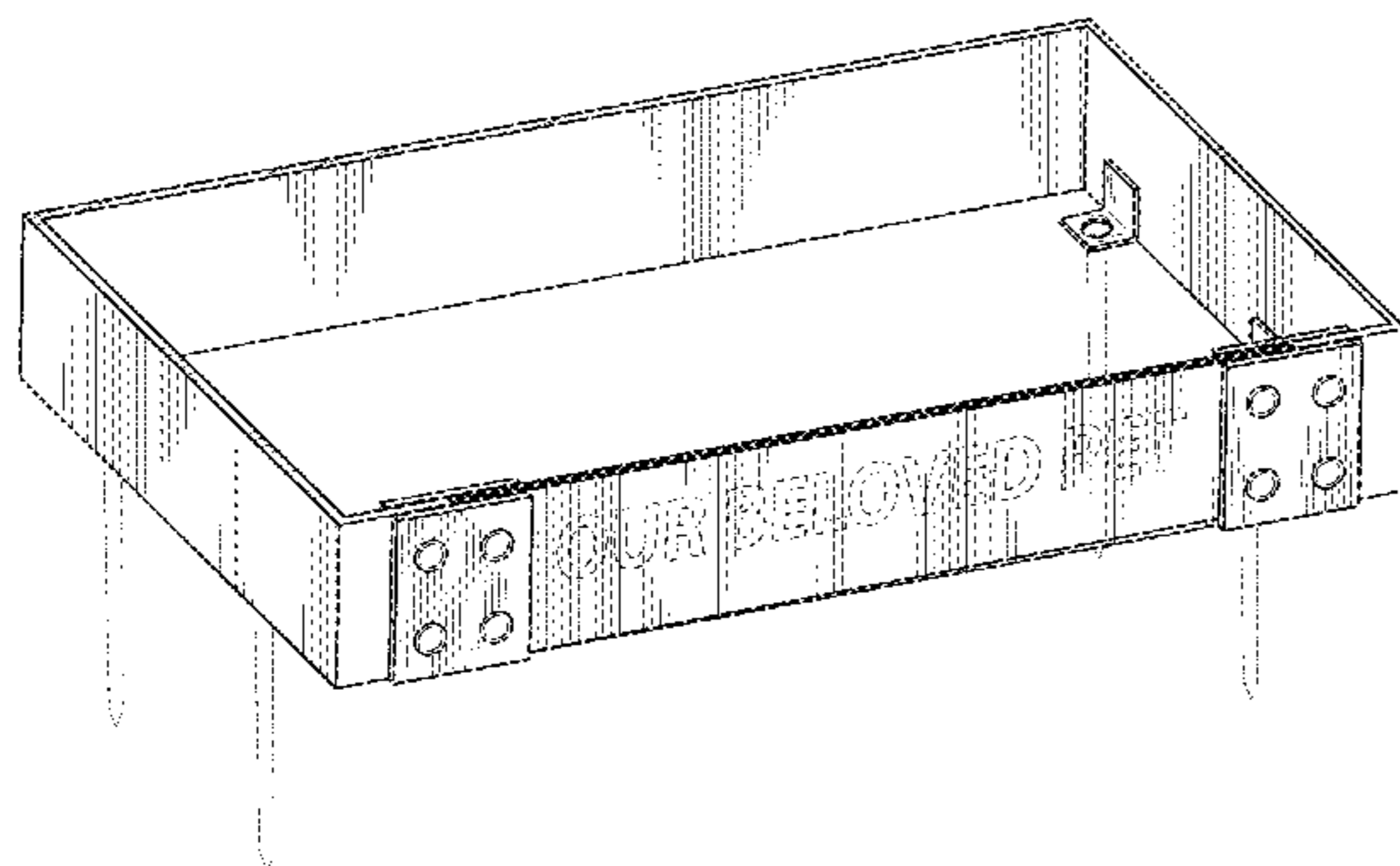

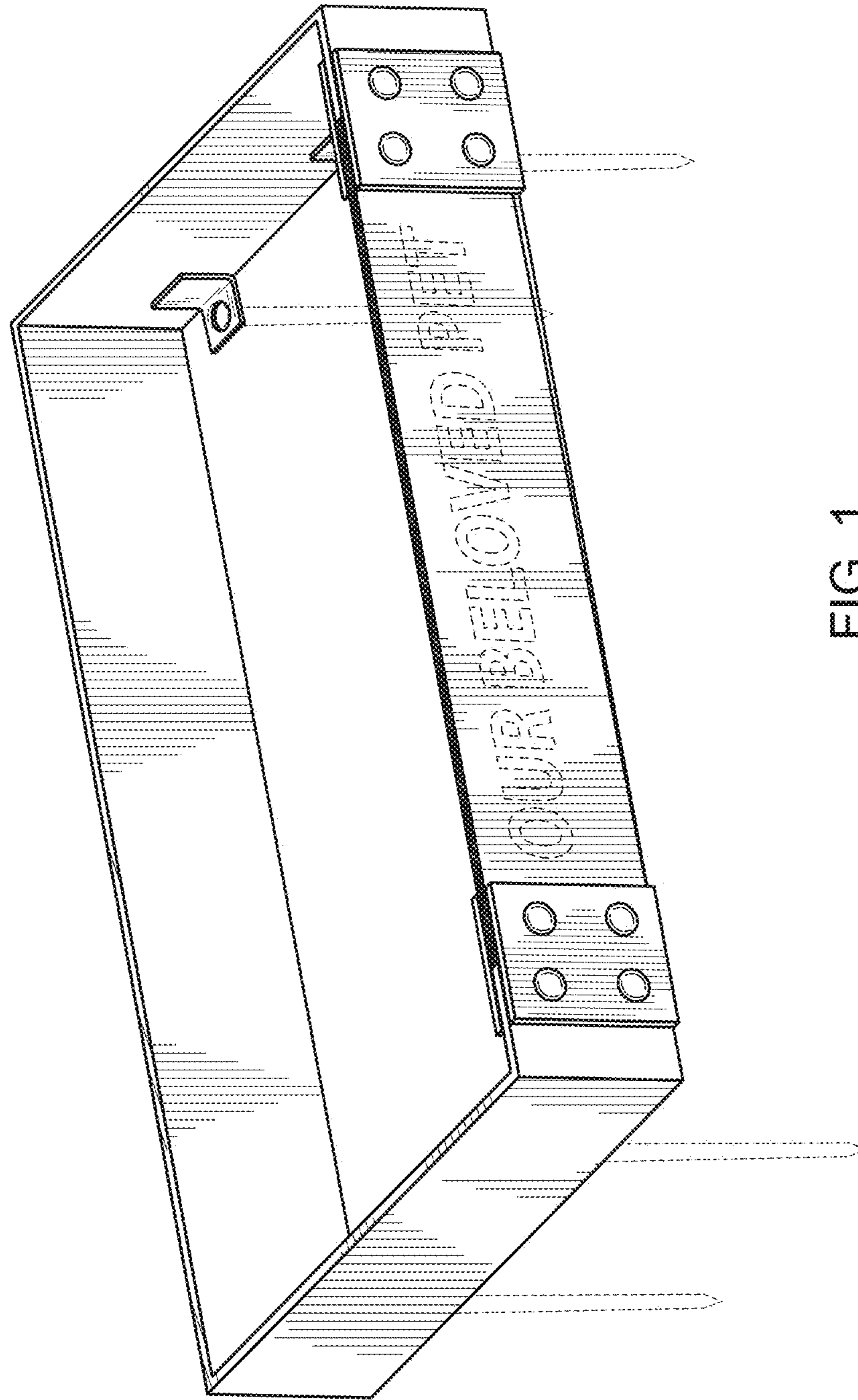

FIG. 1

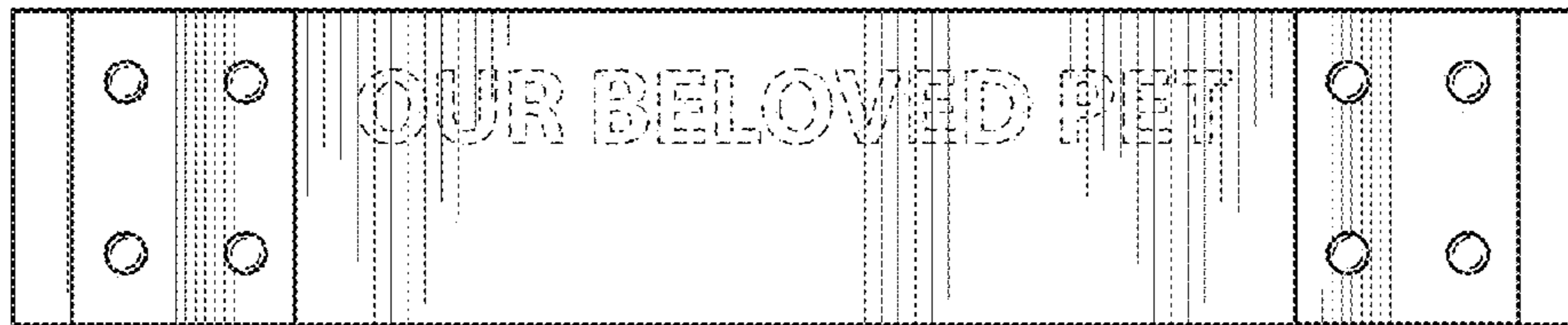

FIG. 2

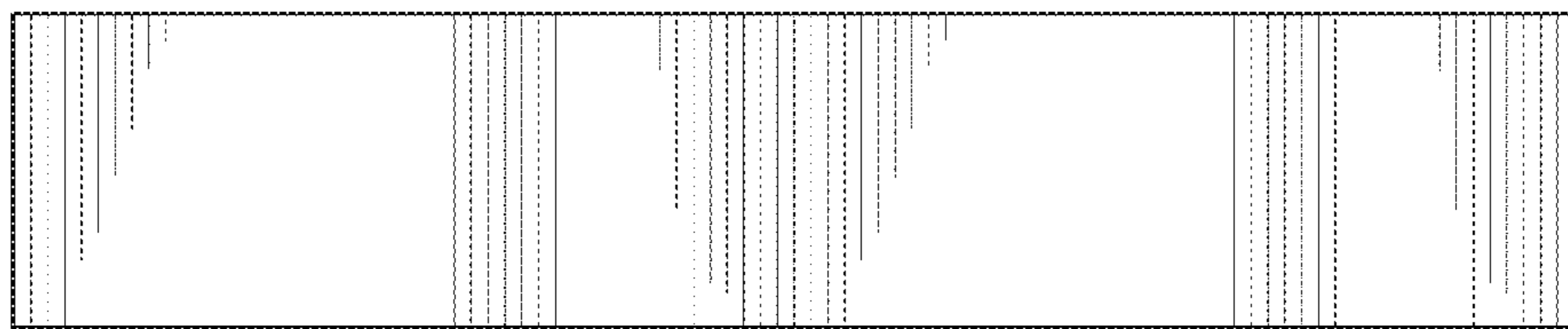

FIG. 3

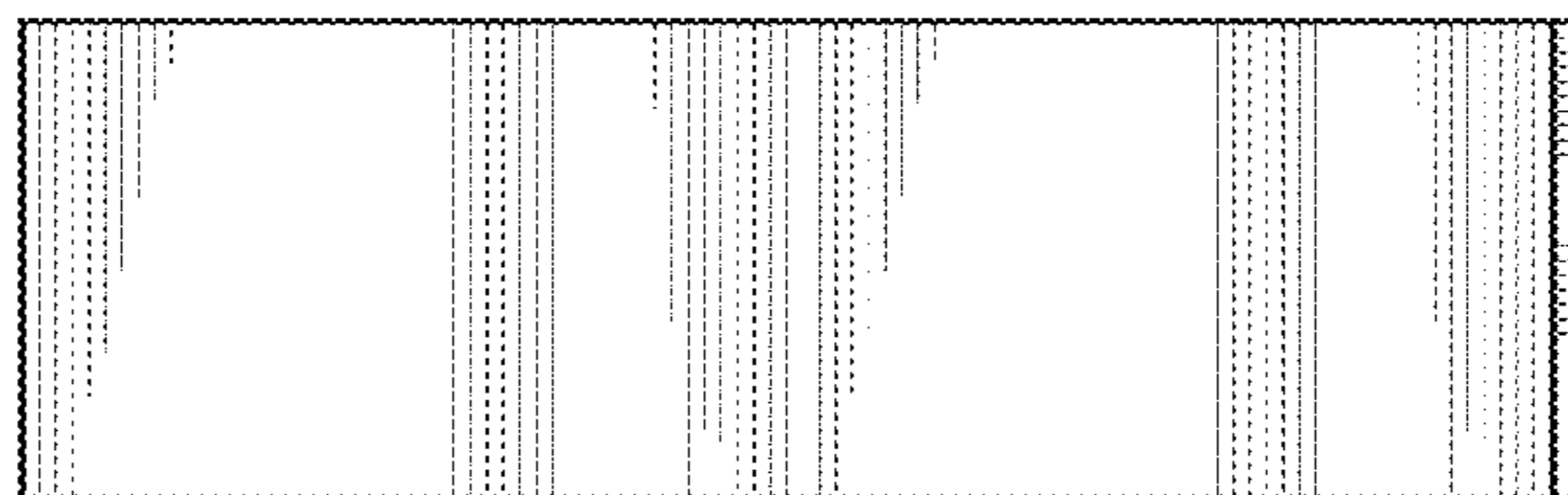

FIG. 4

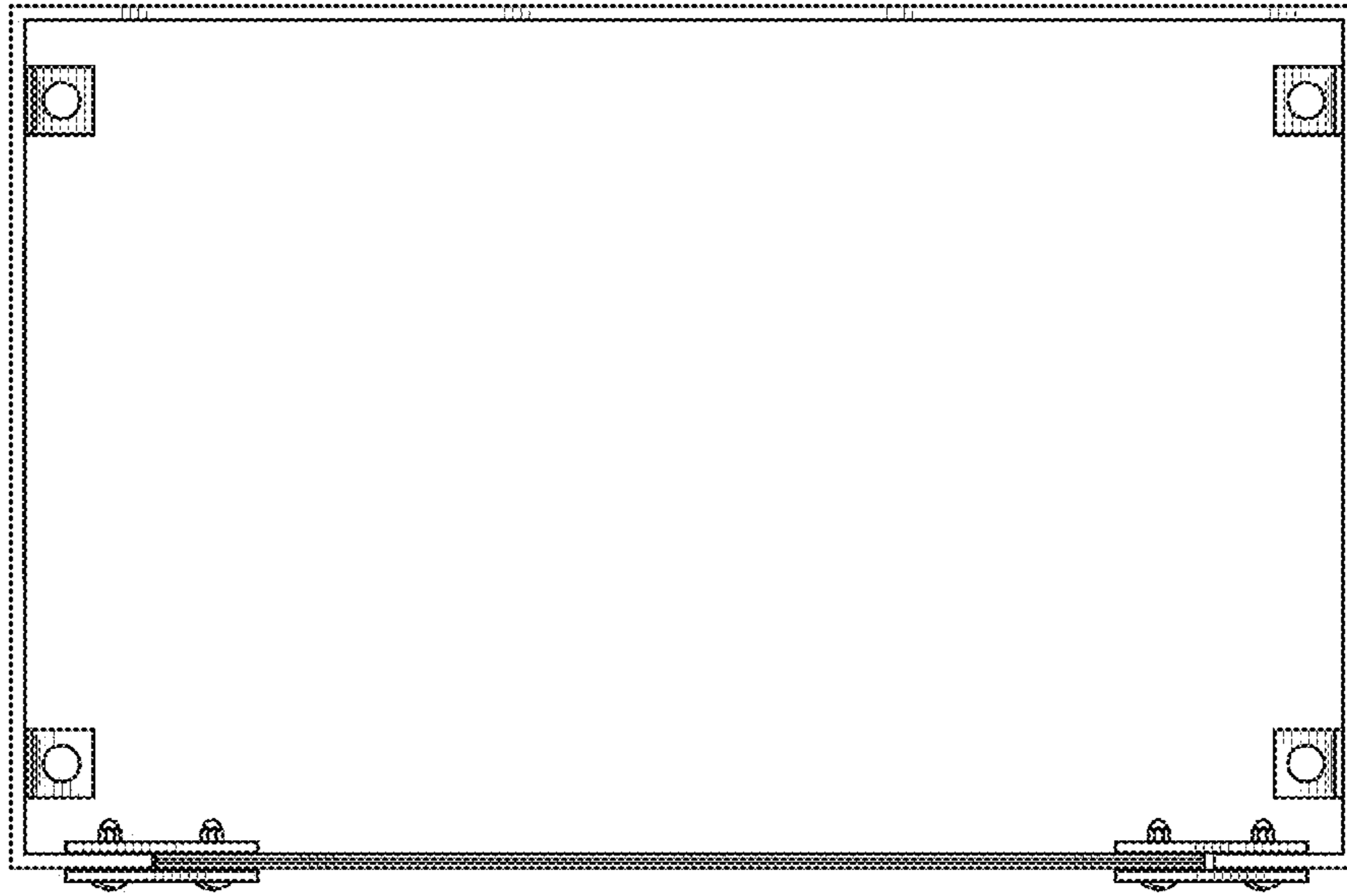

FIG. 5

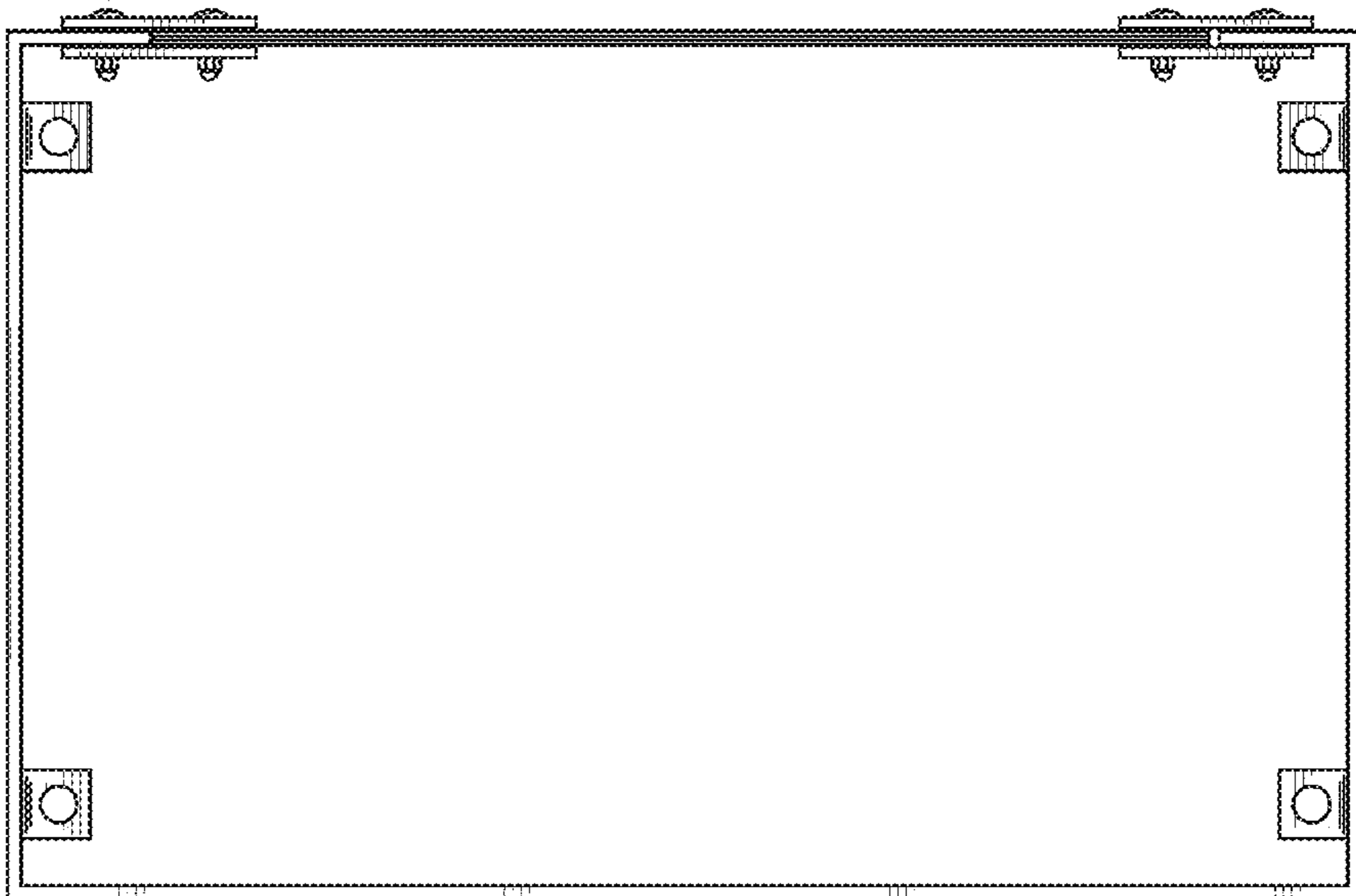

FIG. 6