



US00D693482S

(12) **United States Design Patent**
Merriam

(10) **Patent No.:** **US D693,482 S**

(45) **Date of Patent:** **** Nov. 12, 2013**

(54) **PERMEABLE PAVER BLOCK**

(71) Applicant: **Studio5051, LLC**, Minneapolis, MN
(US)

(72) Inventor: **Howard Merriam**, Minneapolis, MN
(US)

(73) Assignee: **Studio5051, LLC**, Minneapolis, MN
(US)

(**) Term: **14 Years**

(21) Appl. No.: **29/437,461**

(22) Filed: **Nov. 16, 2012**

Related U.S. Application Data

(63) Continuation-in-part of application No. 29/397,625,
filed on Jul. 19, 2011, now Pat. No. Des. 674,115.

(51) **LOC (9) Cl.** **25-01**

(52) **U.S. Cl.**
USPC **D25/113**

(58) **Field of Classification Search**

USPC D25/102-118, 136, 138, 140, 151, 152,
D25/153, 156-162, 164; D21/484-491,
D21/499-504; 405/16, 284, 286;
52/503-505, 574, 575, 596-612;
404/27-42; D8/1

See application file for complete search history.

(56) **References Cited**

U.S. PATENT DOCUMENTS

D27,761 S * 10/1897 Mark D25/106
2,104,356 A * 1/1938 Sanford 52/432

(Continued)

Primary Examiner — Anhdao Doan

(74) *Attorney, Agent, or Firm* — Fredrikson & Byron, P.A.

(57) **CLAIM**

I claim the ornamental design for a permeable paver block, as shown and described.

DESCRIPTION

FIG. 1 is a perspective view of a first embodiment of the permeable paver block of my design;

FIG. 2 is a top plan view thereof;

FIG. 3 is a bottom plan view thereof;

FIG. 4 is an elevation view of one of the ends thereof, all the other ends being a mirror image;

FIG. 5 is a sectional view thereof, taken along line 5-5 of FIG. 2;

FIG. 6 is a perspective view of a second embodiment of the permeable paver block of my design;

FIG. 7 is a top plan view thereof;

FIG. 8 is a bottom plan view thereof;

FIG. 9 is an elevation view of one of the sides thereof, the opposite side being a mirror image;

FIG. 10 is an elevation view of one of the ends thereof, the opposite end being a mirror image;

FIG. 11 is a sectional view thereof, taken along line 11-11 of FIG. 8;

FIG. 12 is a perspective view of a third embodiment of the permeable paver block of my design;

FIG. 13 is a top plan view thereof;

FIG. 14 is a bottom plan view thereof;

FIG. 15 is an elevation view of one of the ends thereof, all the other ends being a mirror image;

FIG. 16 is a sectional view thereof, taken along line 16-16 of FIG. 14;

FIG. 17 is a perspective view of a fourth embodiment of the permeable paver block of my design;

FIG. 18 is a top plan view thereof;

FIG. 19 is a bottom plan view thereof;

FIG. 20 is an elevation view of one of the sides thereof, the opposite side being a mirror image;

FIG. 21 is an elevation view of one of the ends thereof, the opposite end being a mirror image; and,

FIG. 22 is a sectional view thereof, taken along line 22-22 of FIG. 19.

The broken lines in the drawing views represent the bounds of the claim and form no part of the claimed design.

1 Claim, 13 Drawing Sheets

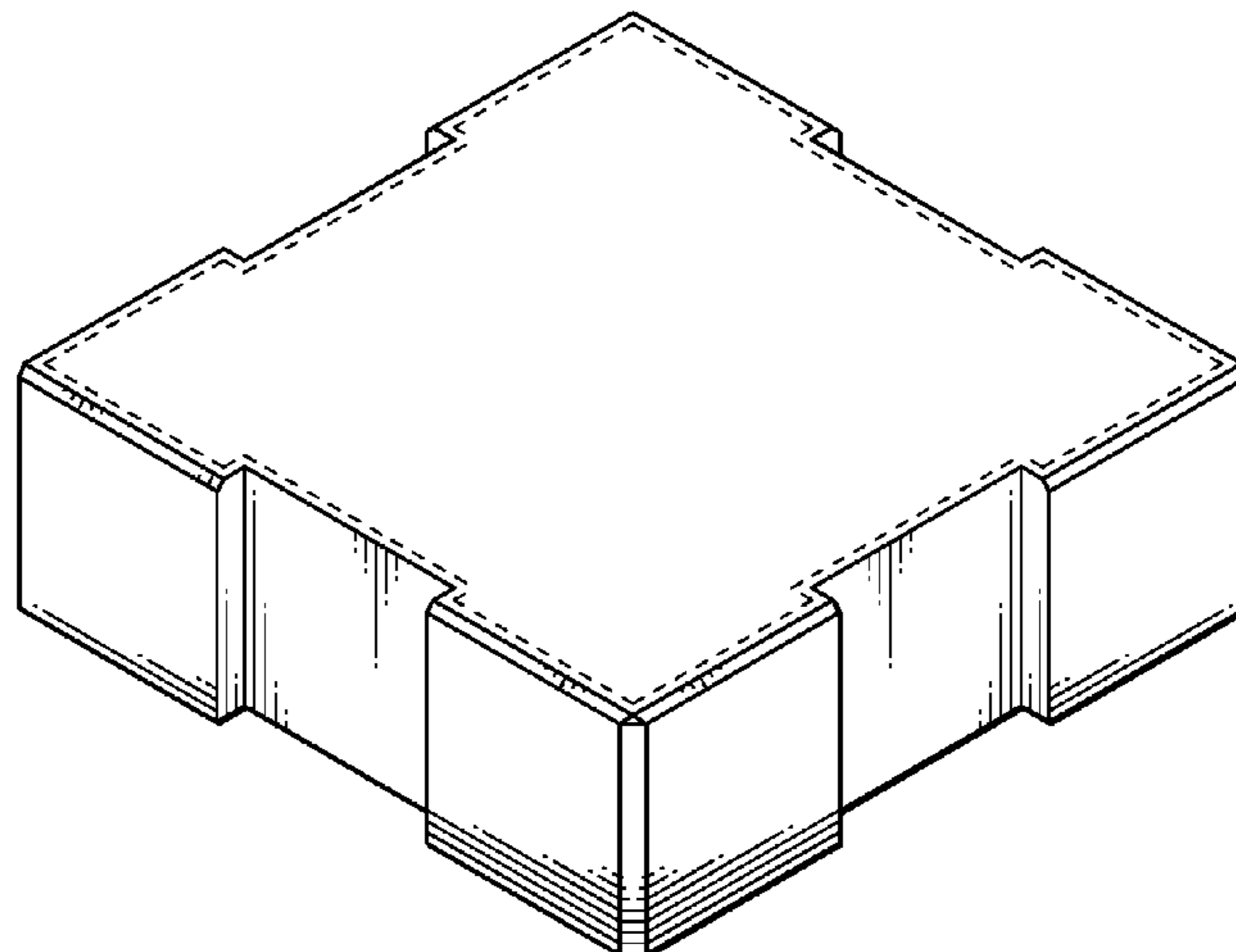

US D693,482 S

Page 2

(56)

References Cited

U.S. PATENT DOCUMENTS

D319,108 S * 8/1991 van Weerden et al. D25/118
D319,316 S * 8/1991 van Weerden et al. D25/118
5,348,417 A * 9/1994 Scheiwiller 404/41

D547,882 S * 7/2007 Metten D25/113
D582,056 S * 12/2008 Plies D25/113
D582,057 S * 12/2008 Plies D25/113
D634,859 S * 3/2011 Barkman D25/113
D663,439 S * 7/2012 Edwards D25/113

* cited by examiner

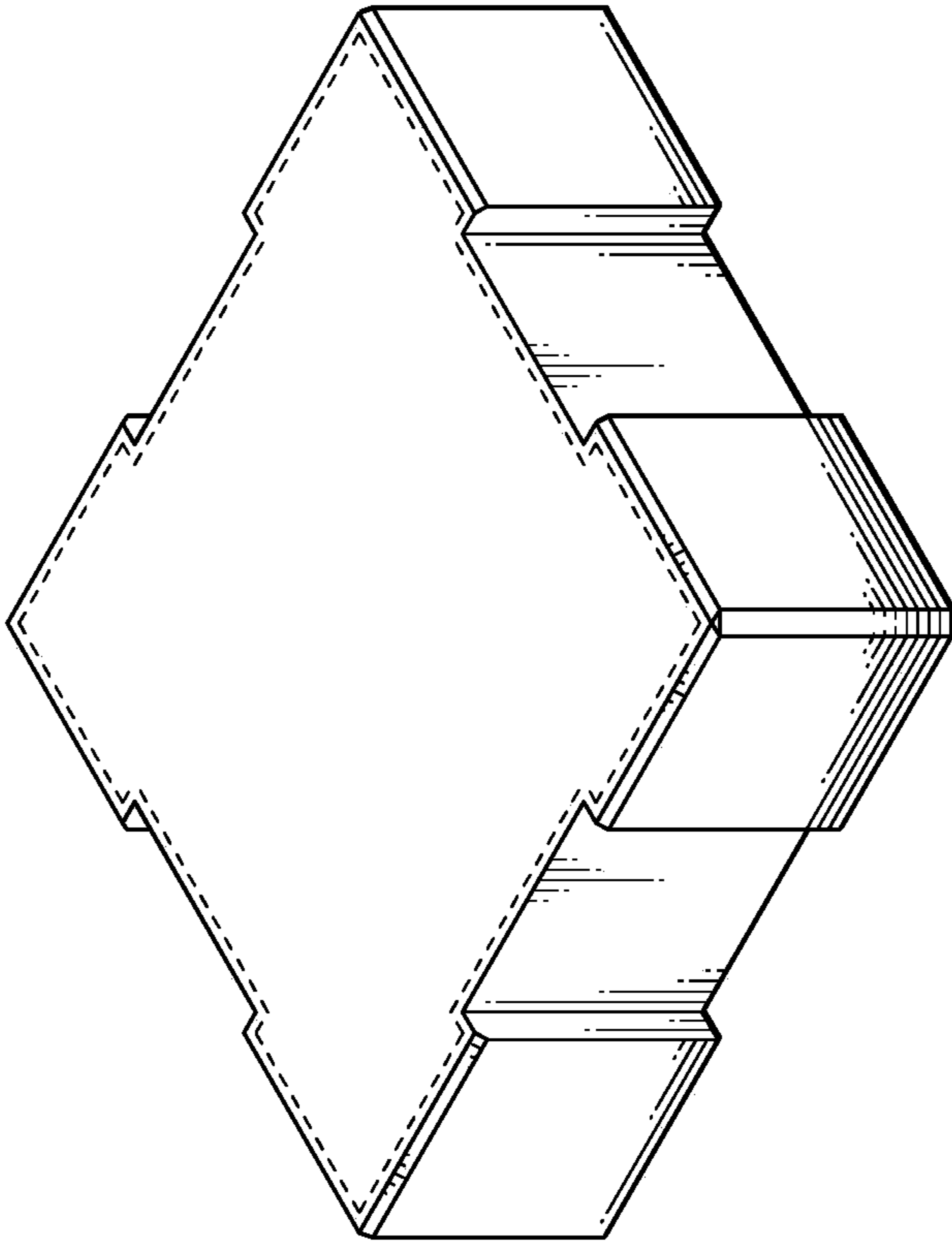

FIG. 1

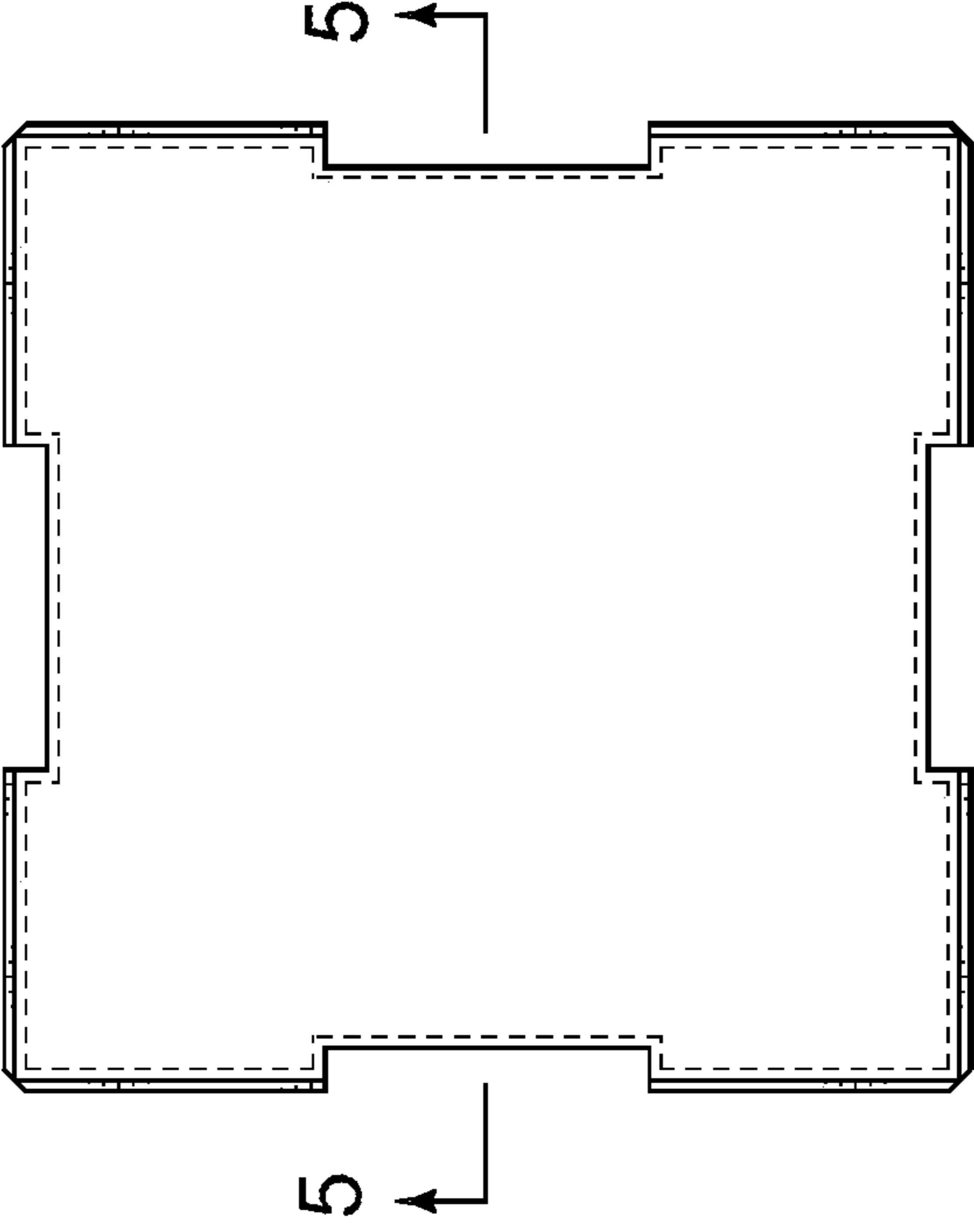

FIG. 2

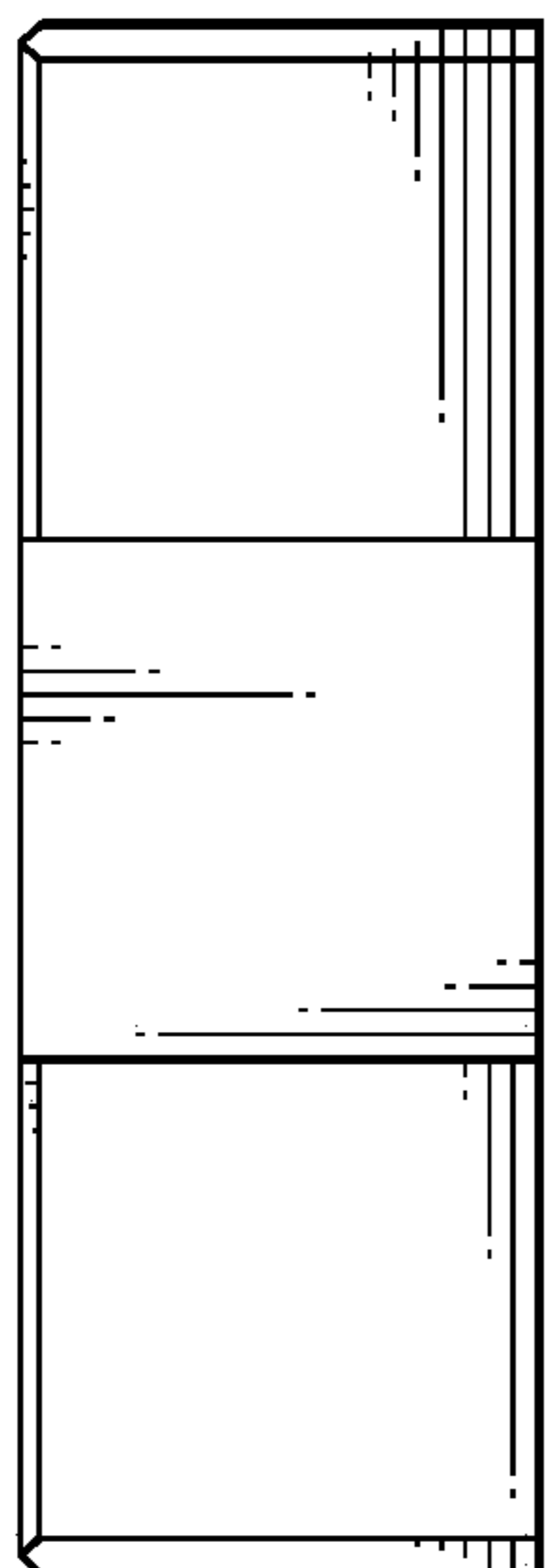

FIG. 4

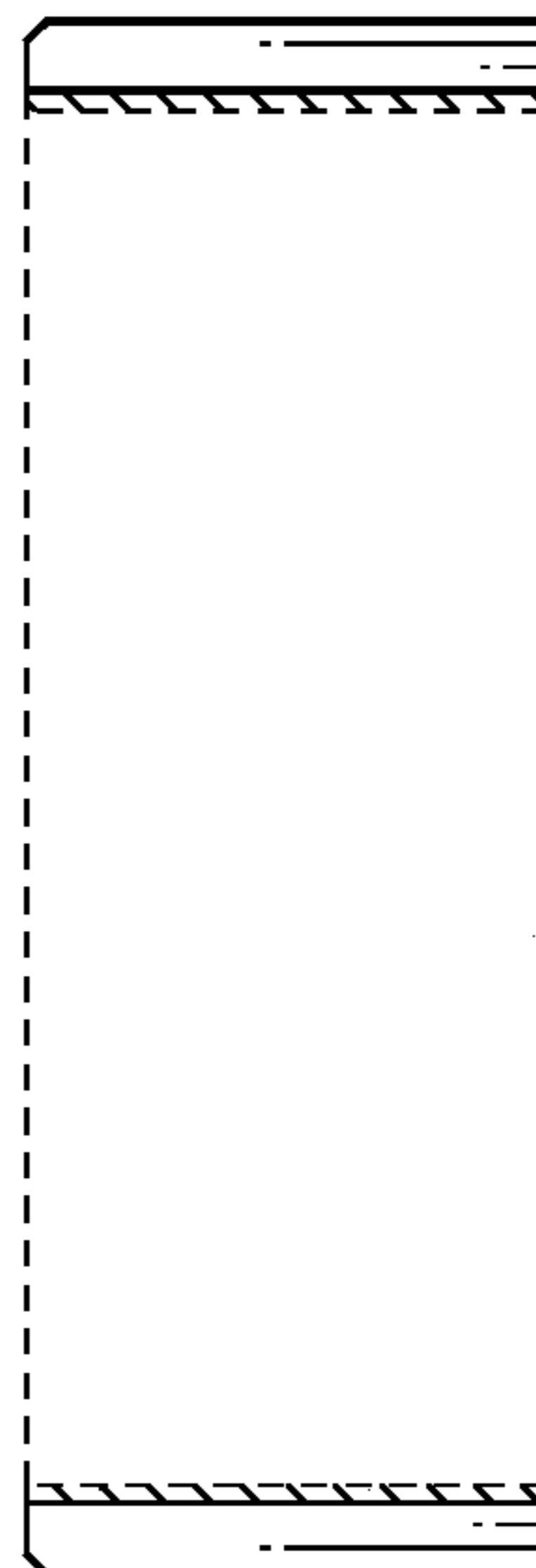

FIG. 5

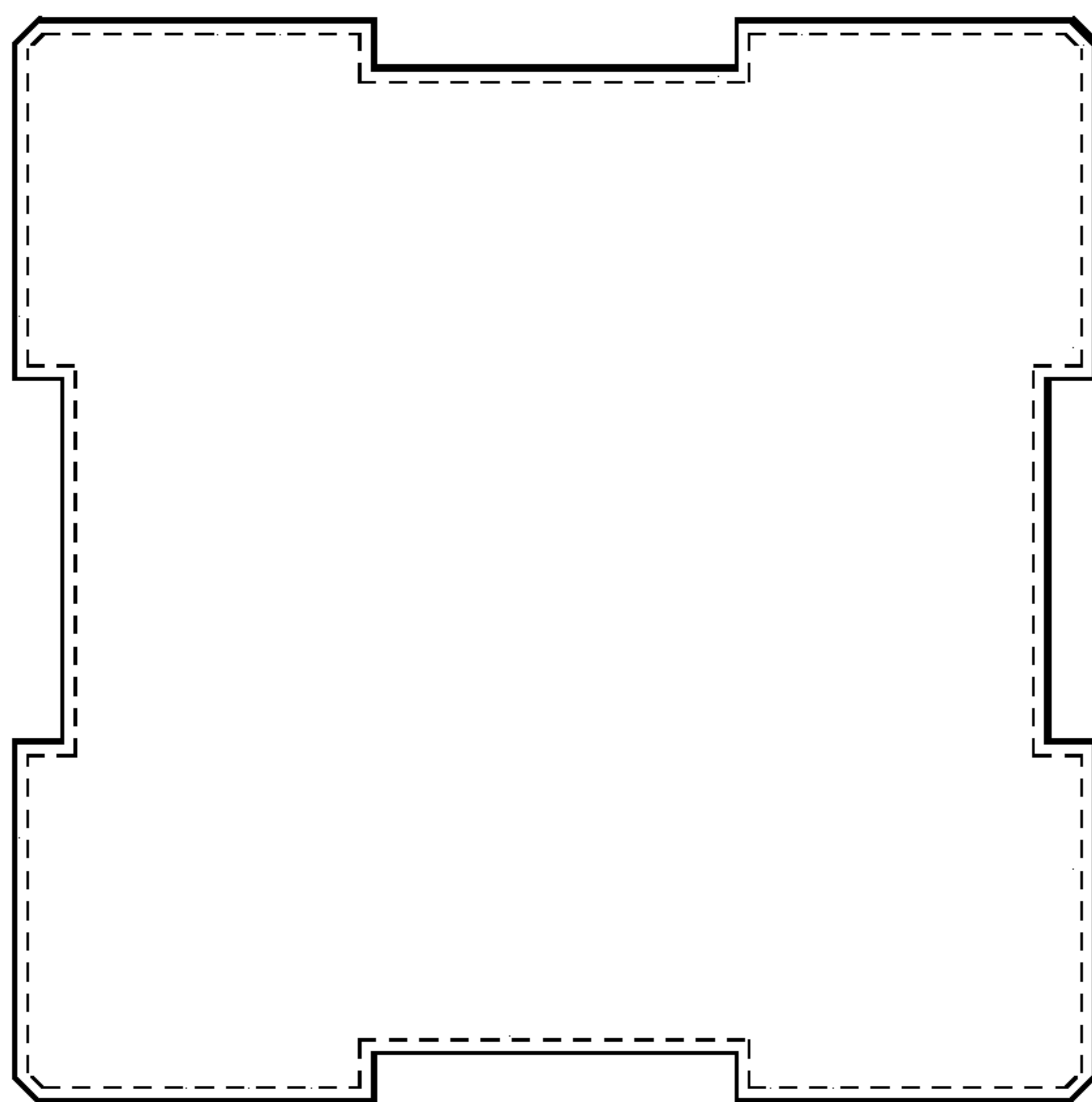

FIG. 3

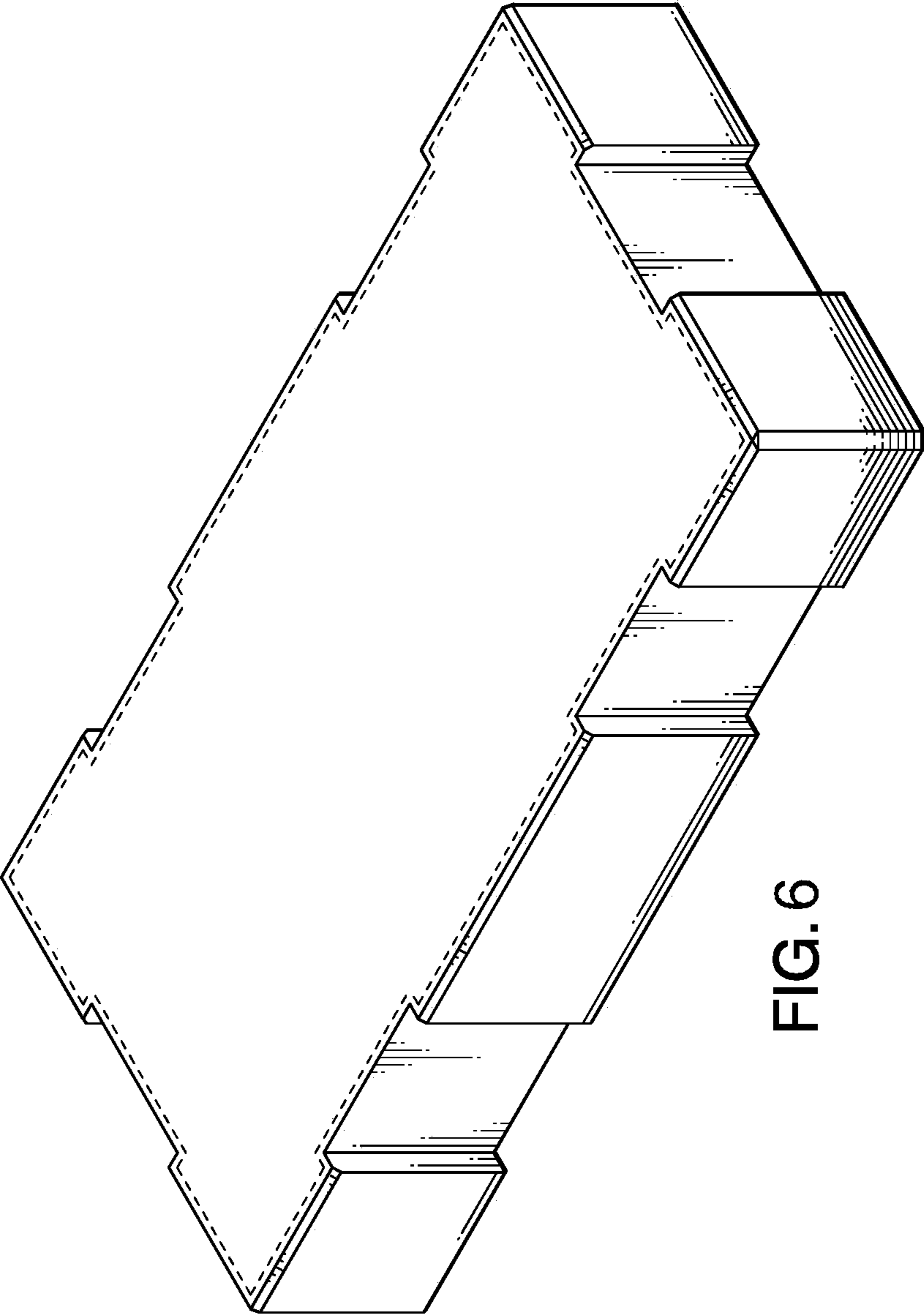
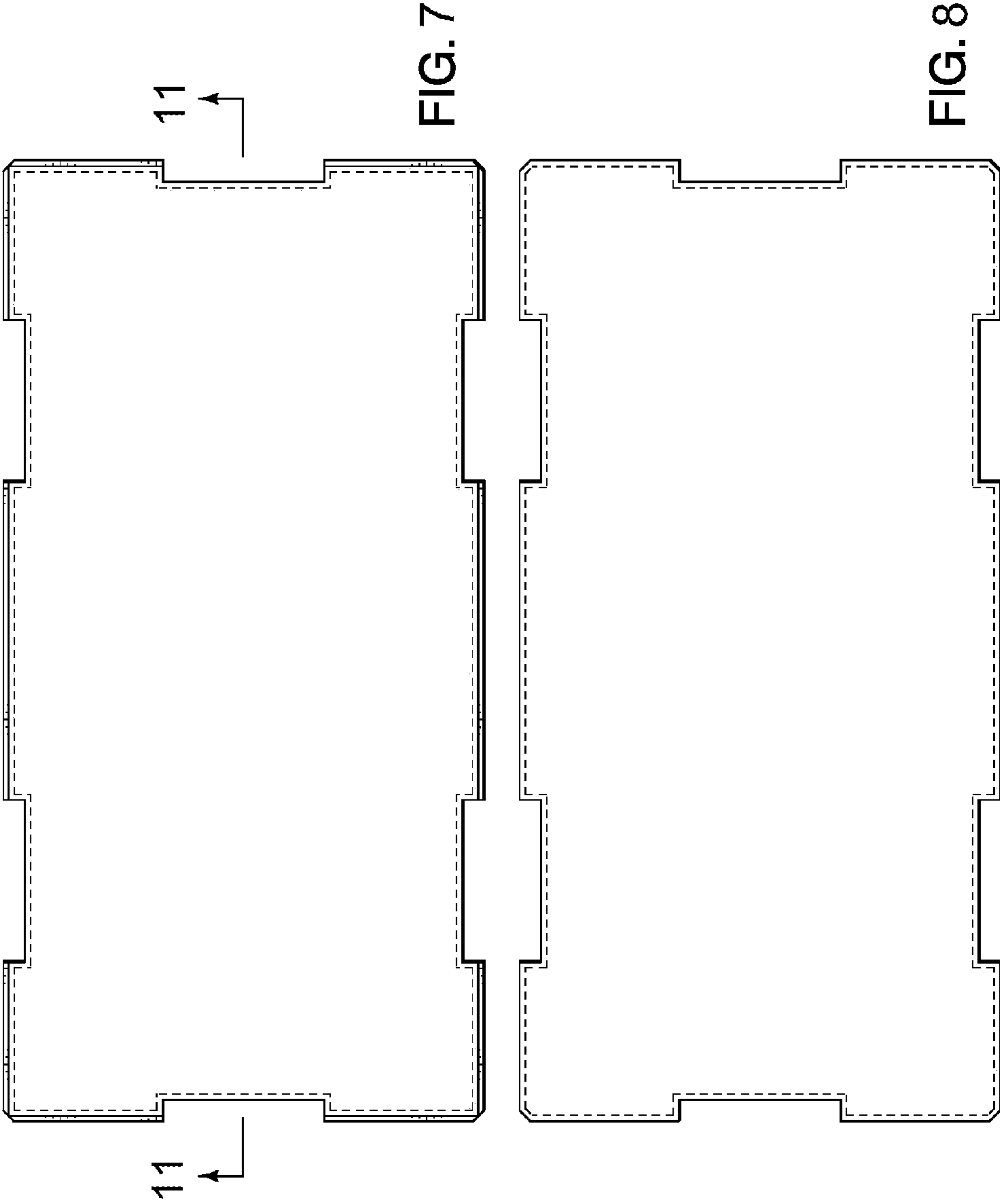

FIG. 6



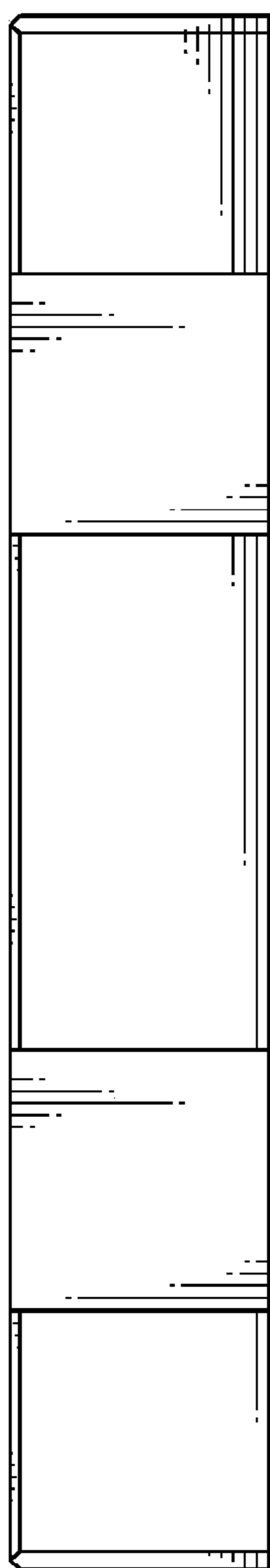

FIG. 9



FIG. 10

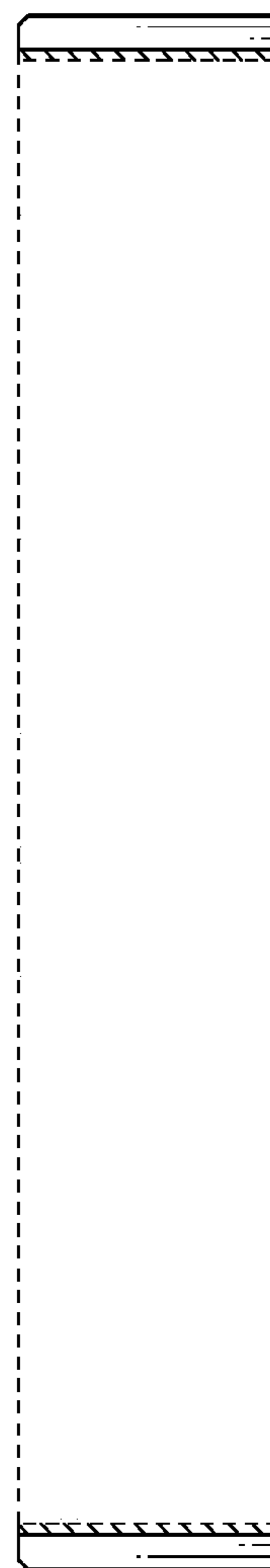

FIG. 11

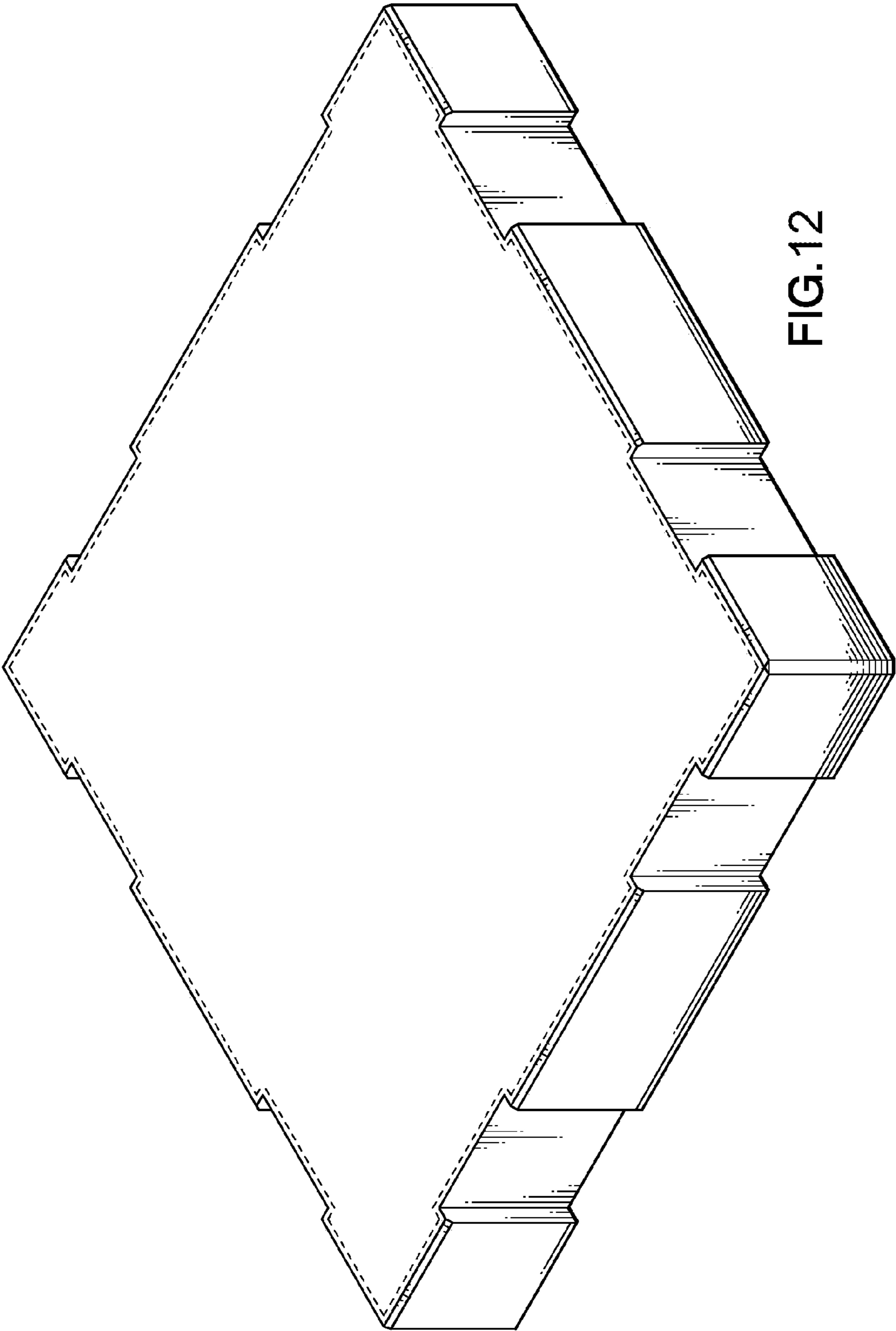

FIG. 12

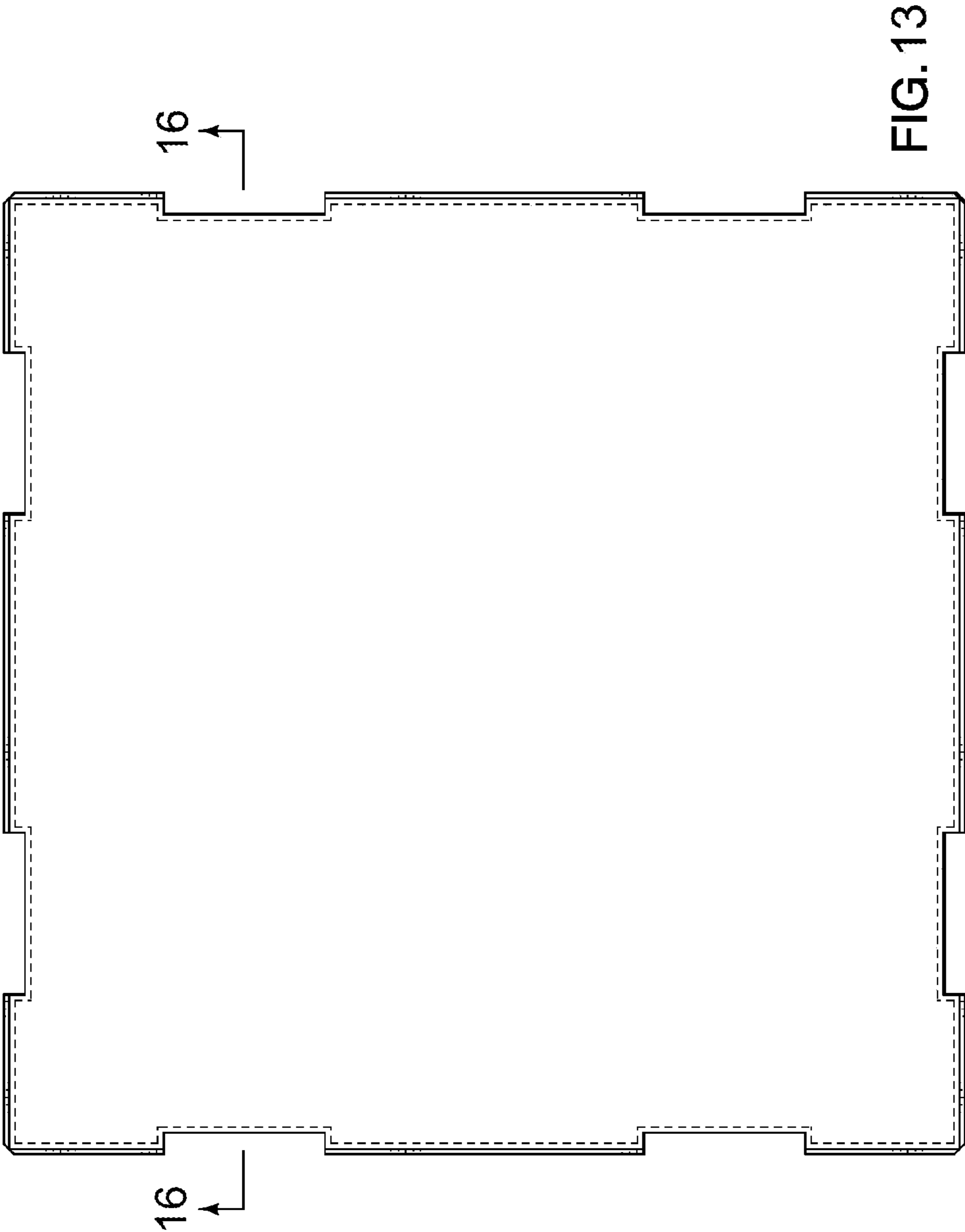
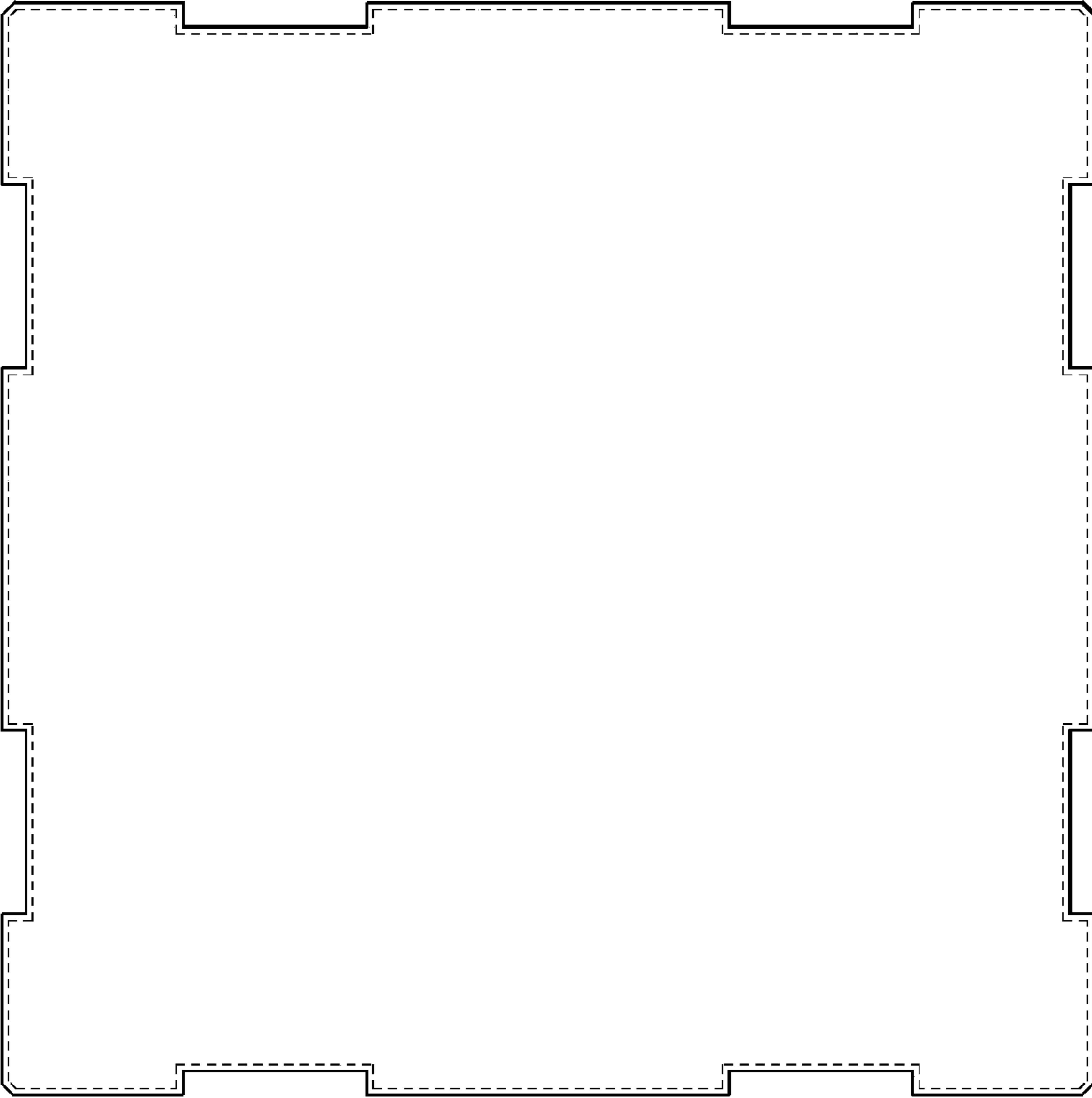

FIG. 14



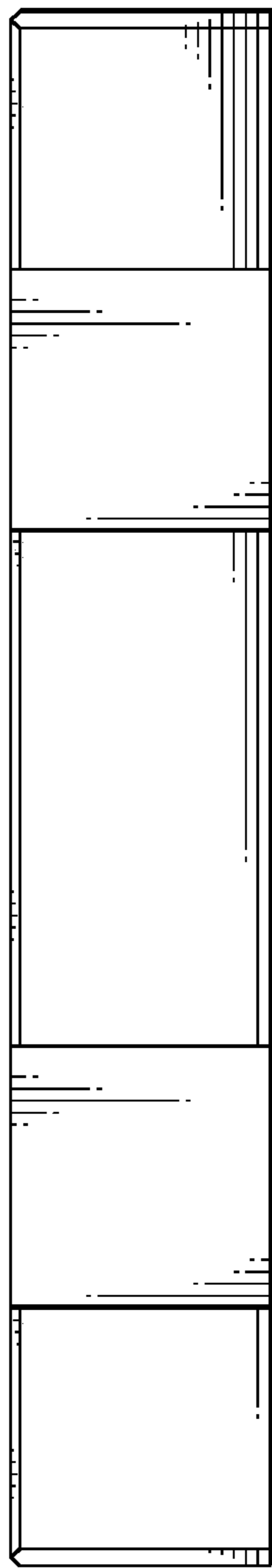

FIG. 15

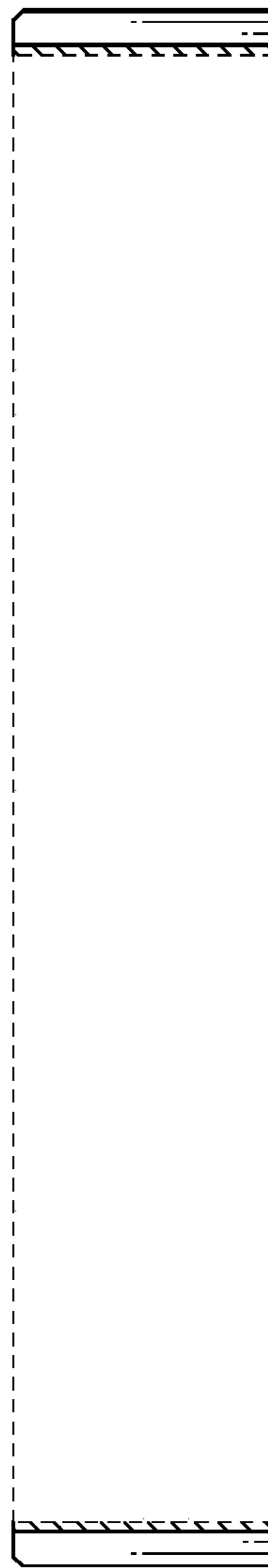

FIG. 16

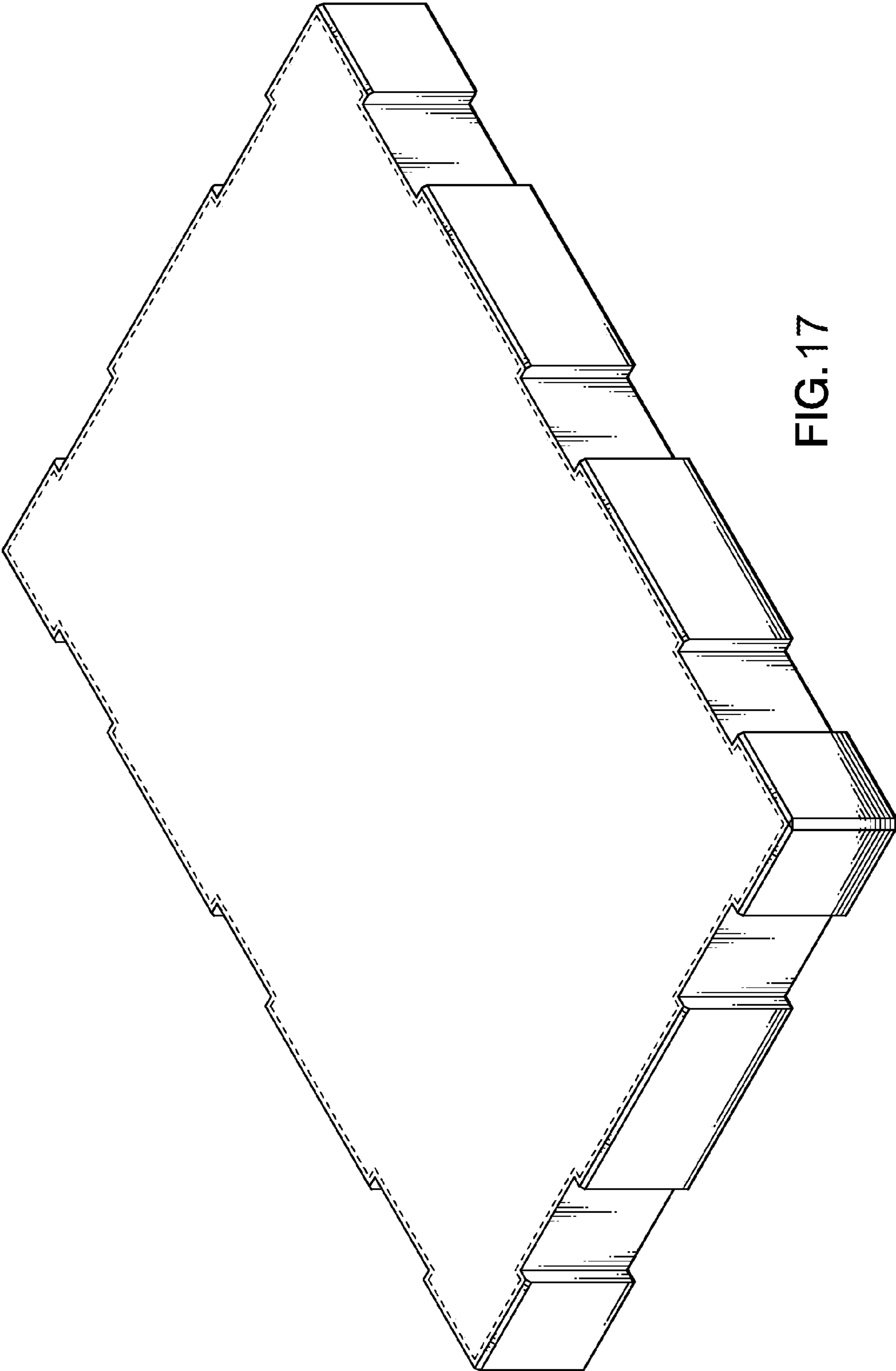

FIG. 17

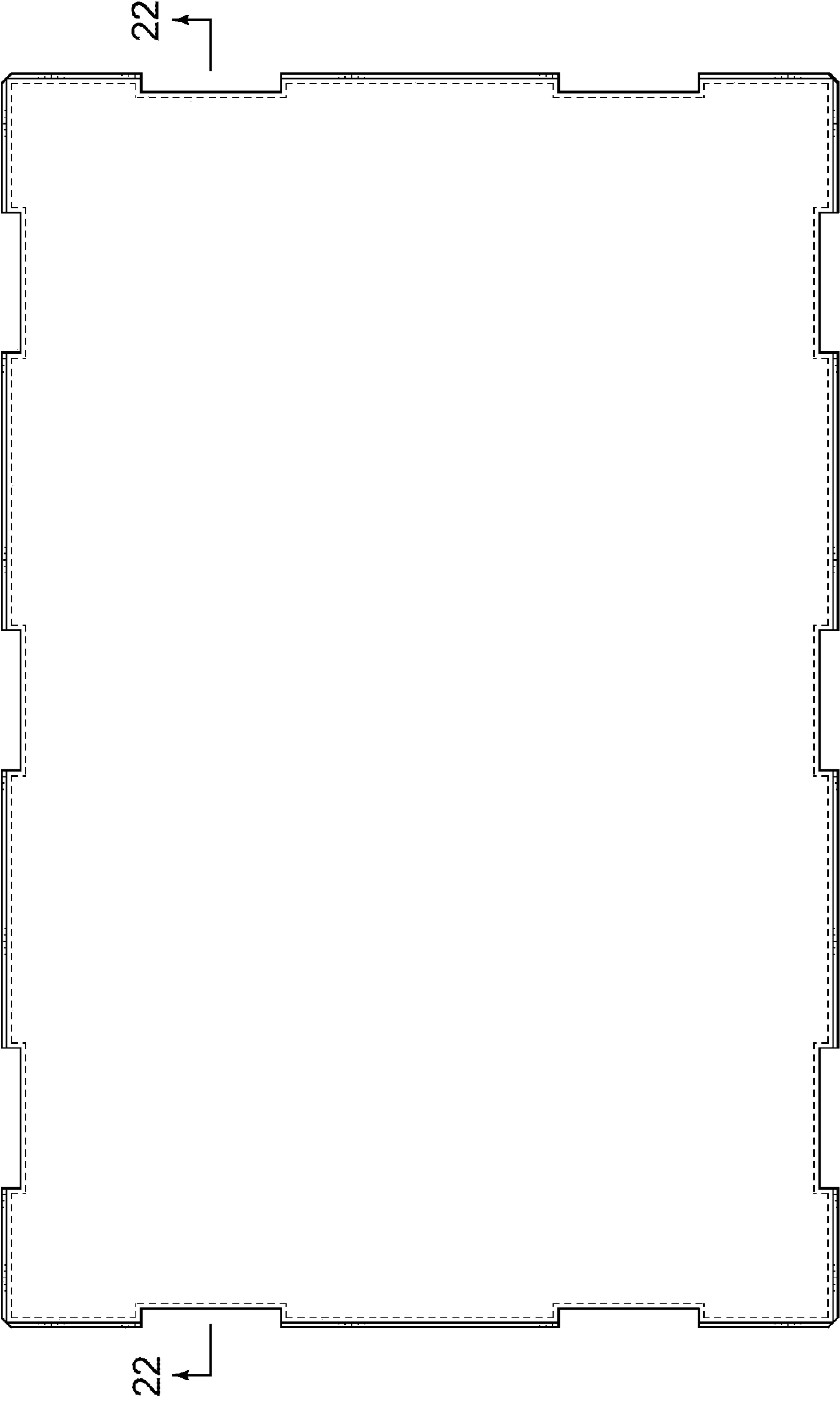

FIG. 18

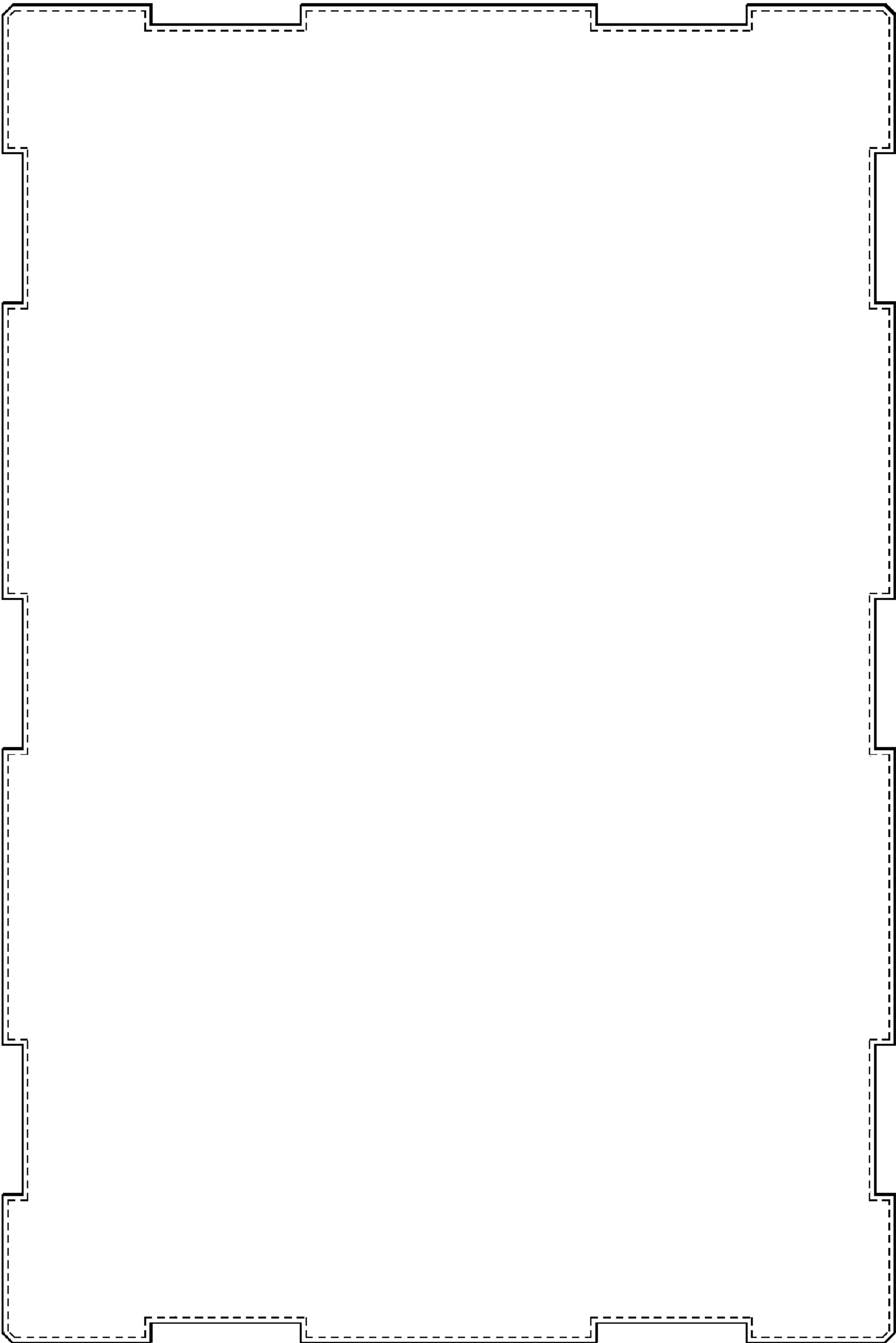

FIG. 19

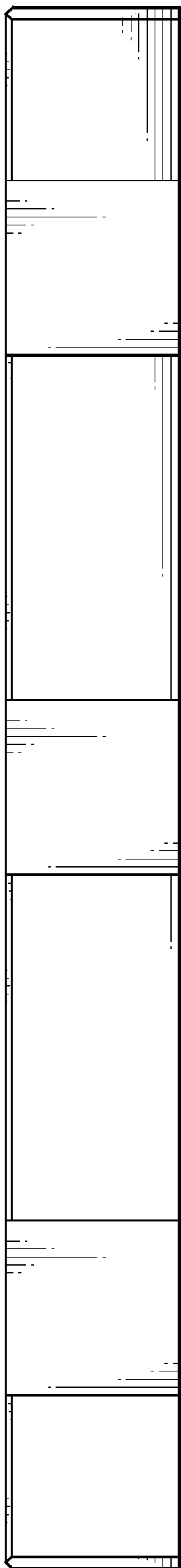

FIG. 20

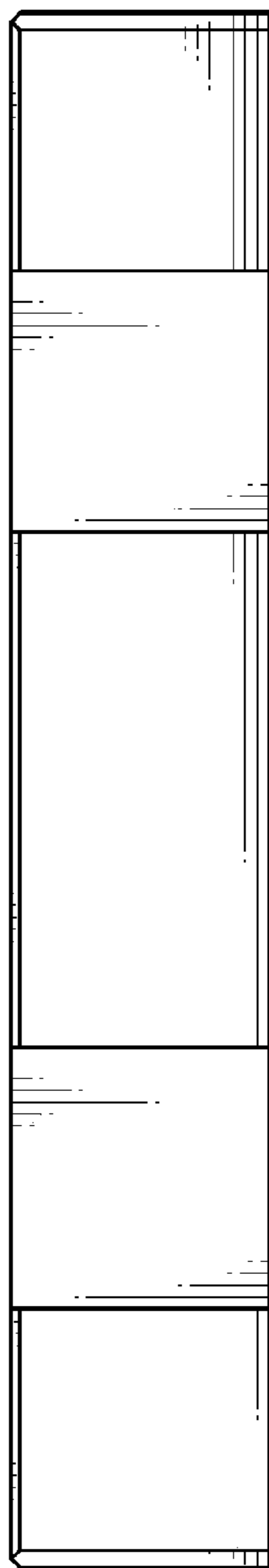

FIG. 21

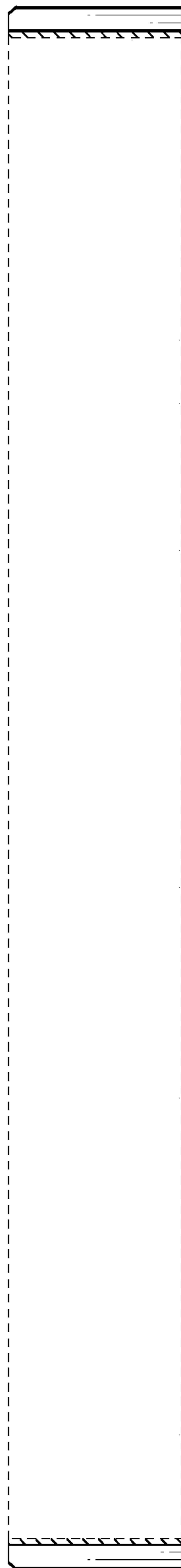

FIG. 22