

US00D693456S

(12) **United States Design Patent**  
**Amirouche et al.**

(10) **Patent No.:** **US D693,456 S**

(45) **Date of Patent:** **\*\* Nov. 12, 2013**

(54) **MULTI-DRUG DELIVERY SYSTEM**

(75) Inventors: **Farid Amirouche**, Highland Park, IL (US); **Arash N. Attar**, Chicago, IL (US); **Matthew L. Cantwell**, Northbrook, IL (US)

(73) Assignee: **Picolife Technologies, LLC**, Deerfield, IL (US)

(\*\*) Term: **14 Years**

(21) Appl. No.: **29/413,587**

(22) Filed: **Feb. 17, 2012**

(51) **LOC (9) Cl.** ..... **24-01**

(52) **U.S. Cl.**  
USPC ..... **D24/108**

(58) **Field of Classification Search**  
USPC ..... D24/111, 169, 186, 108; 604/30, 500, 604/65, 67, 151, 154, 189, 191, 218, 232, 604/246, 256, 260, 891.1

See application file for complete search history.

(56) **References Cited**

U.S. PATENT DOCUMENTS

D308,420	S *	6/1990	Frantz	.....	D24/111
D323,893	S *	2/1992	Arioka	.....	D24/169
5,147,323	A *	9/1992	Haber et al.	.....	604/191
5,745,378	A *	4/1998	Barker et al.	.....	604/30
7,311,693	B2 *	12/2007	Shekalim	.....	604/67

D564,087	S *	3/2008	Yodfat et al.	.....	D24/108
D585,543	S *	1/2009	Yodfat et al.	.....	D24/111
2007/0233051	A1 *	10/2007	Hohl et al.	.....	604/891.1
2010/0292651	A1 *	11/2010	Yodfat et al.	.....	604/189
2011/0004188	A1 *	1/2011	Shekalim	.....	604/500

\* cited by examiner

*Primary Examiner* — Wan Laymon

(74) *Attorney, Agent, or Firm* — Finnegan, Henderson, Farabow, Garrett & Dunner, LLP

(57) **CLAIM**

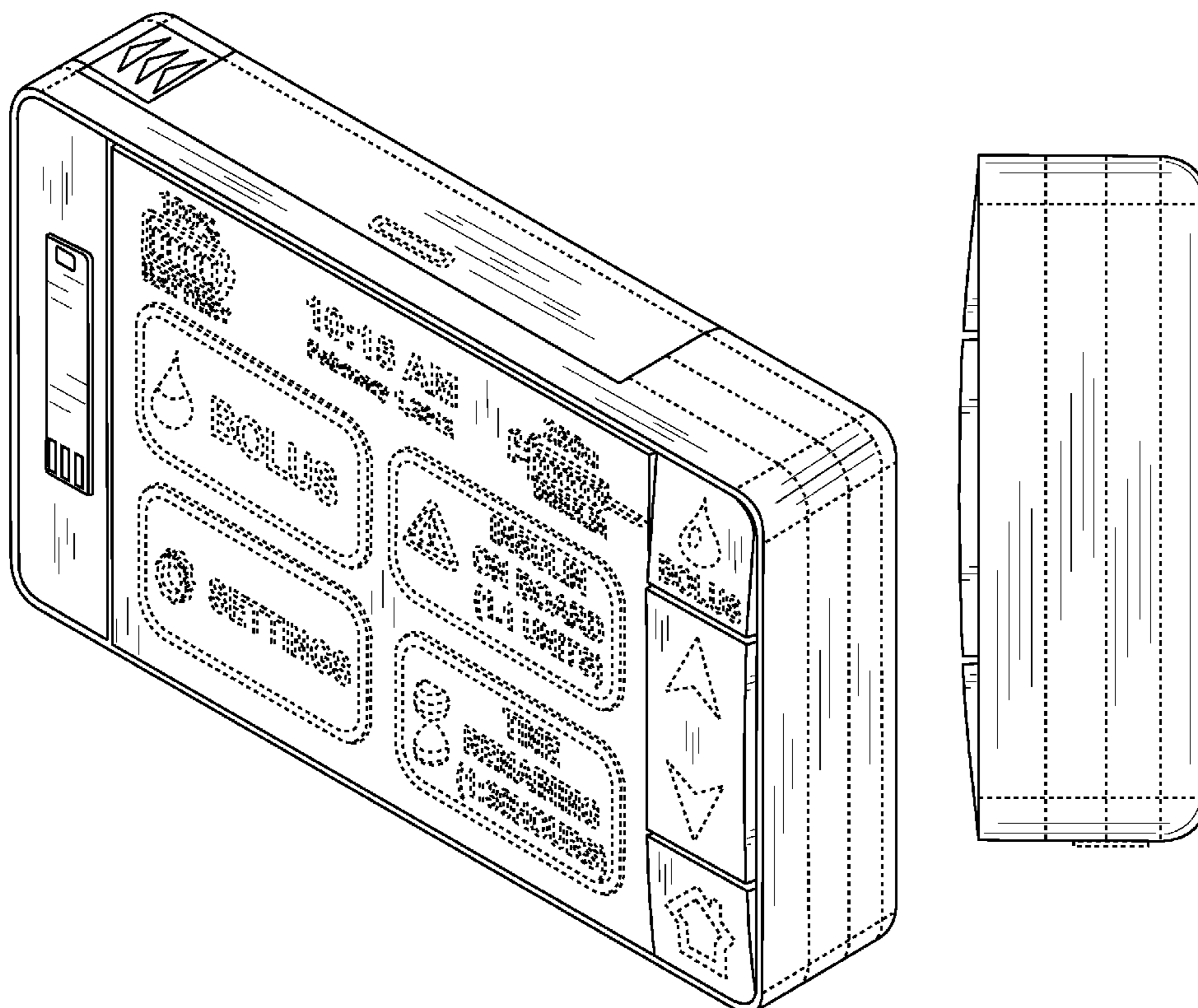
The ornamental design for a multi-drug delivery system, as shown and described.

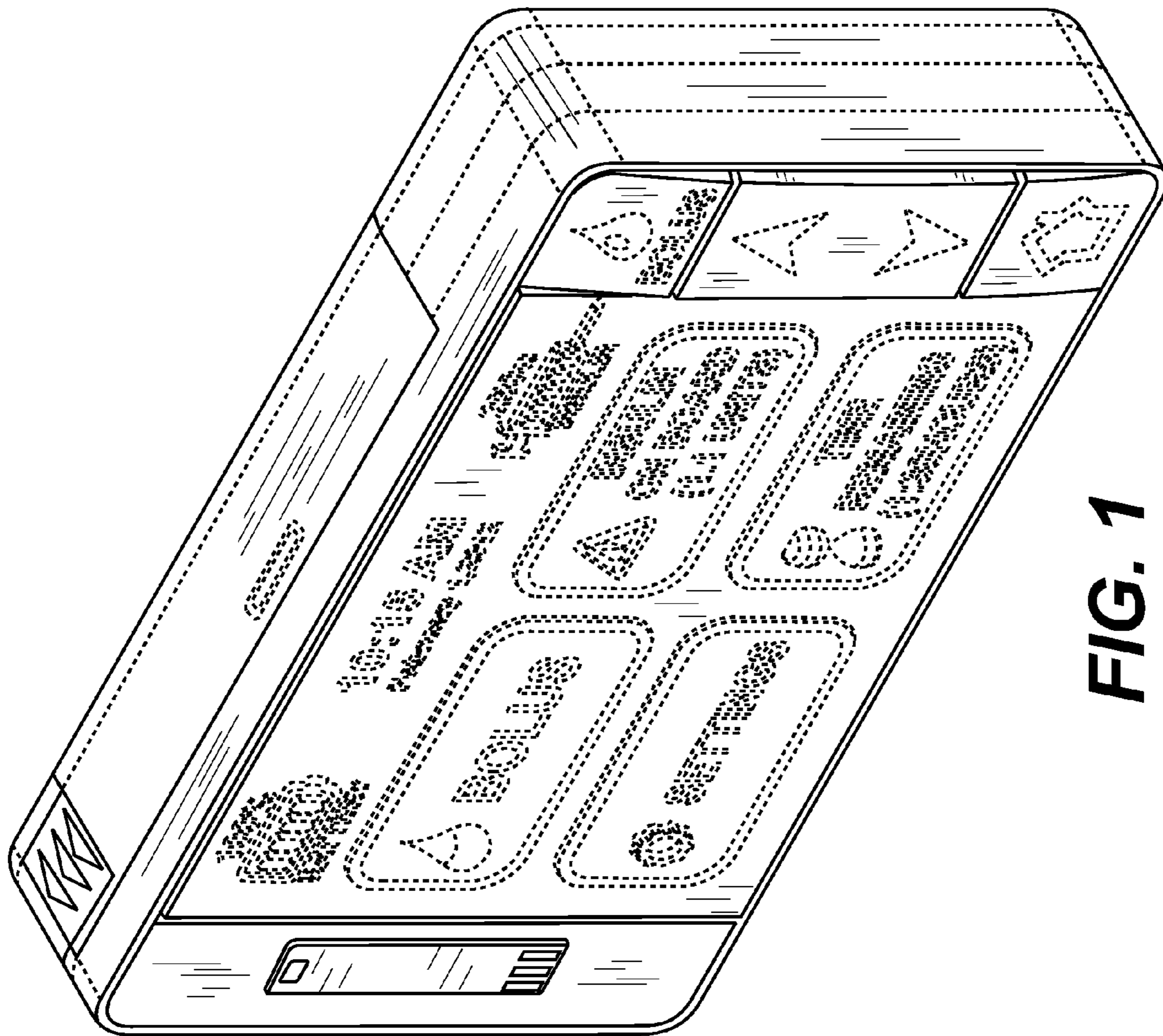
**DESCRIPTION**

FIG. 1 is a perspective view of a multi-drug delivery system showing our new design; FIG. 2 is a front elevation view thereof; FIG. 3 is a rear elevation view thereof; FIG. 4 is a right side elevation view thereof; FIG. 5 is a left side elevation view thereof; FIG. 6 is a top plan view thereof; and, FIG. 7 is a bottom plan view thereof.

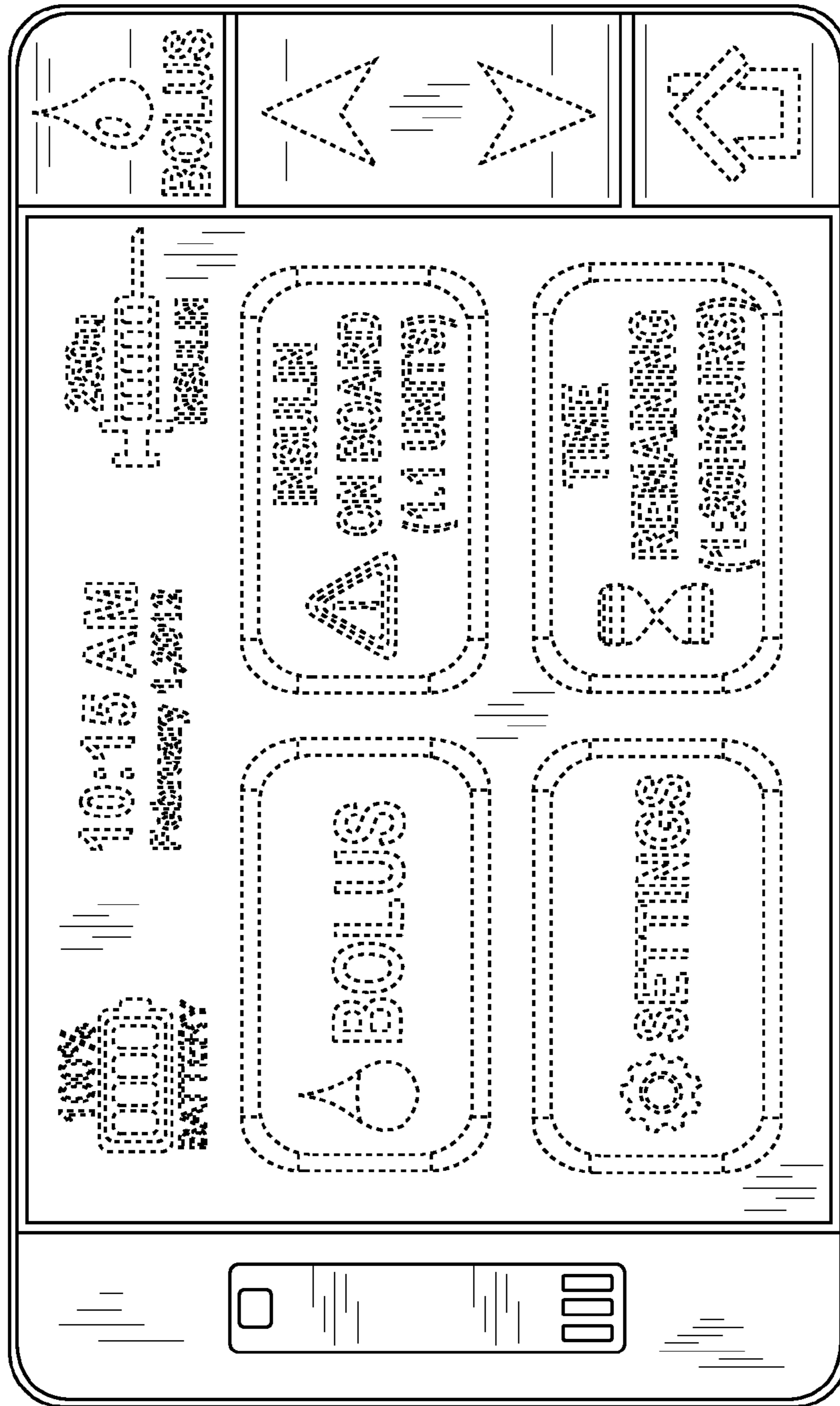
The even-length broken lines showing of the multi-drug-delivery system and the uneven-length broken lines showing the unclaimed elements are for environmental purposes only and form no part of the claimed design.

**1 Claim, 7 Drawing Sheets**

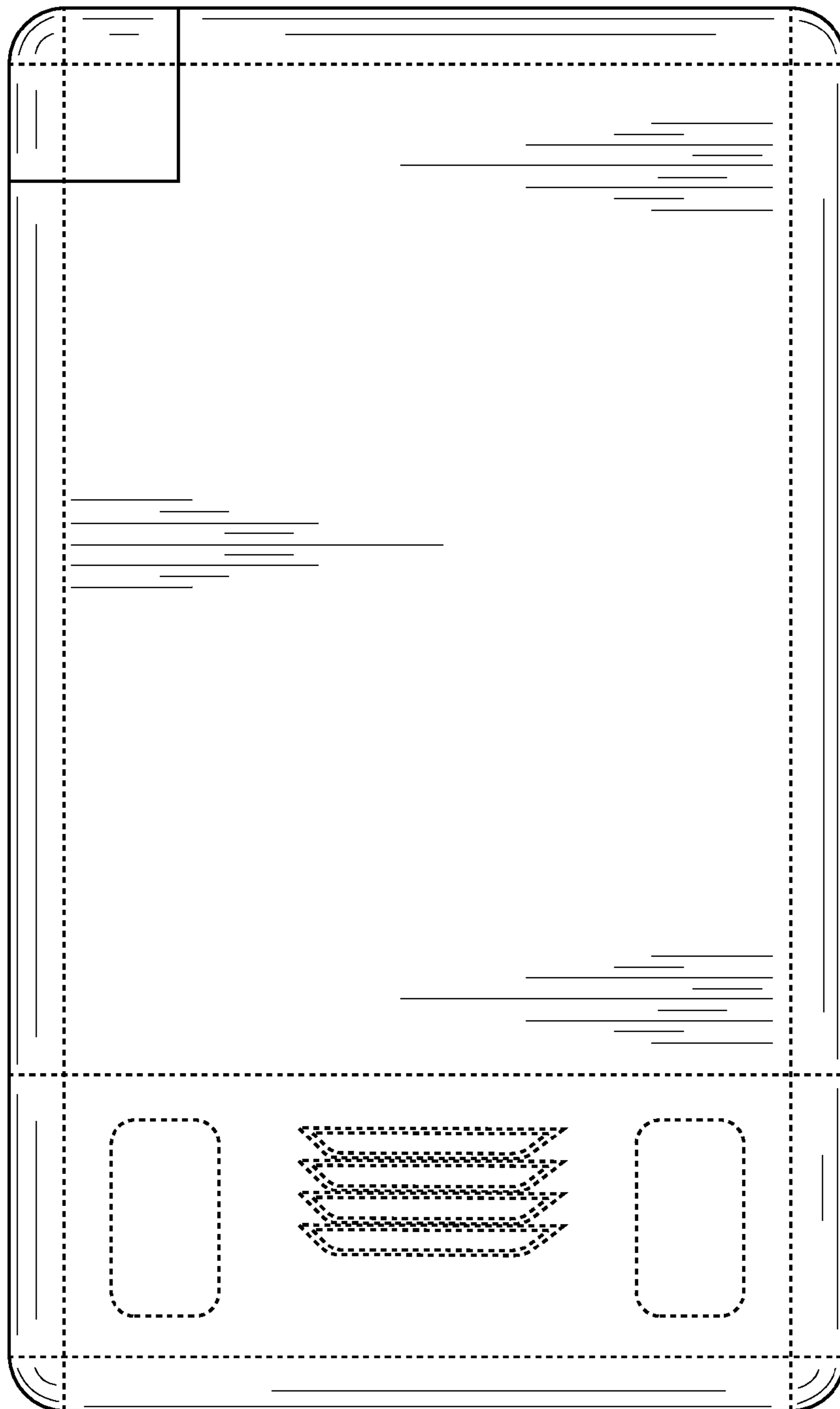




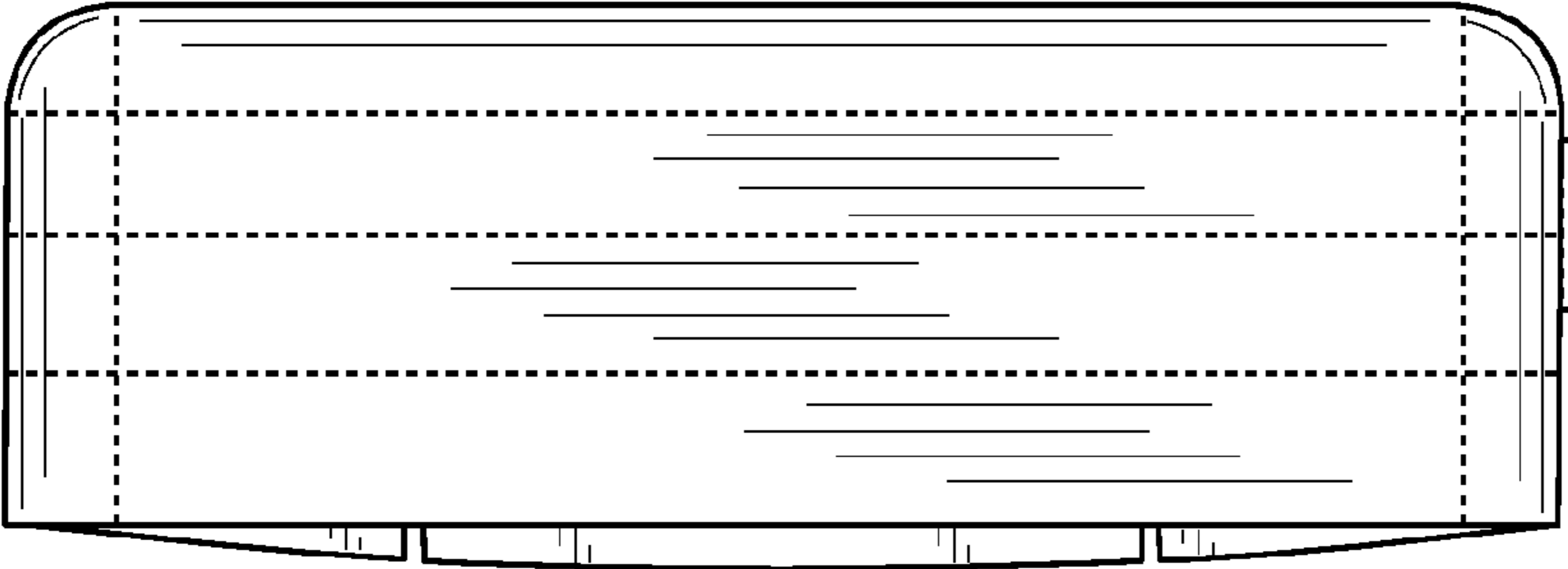
**FIG. 1**



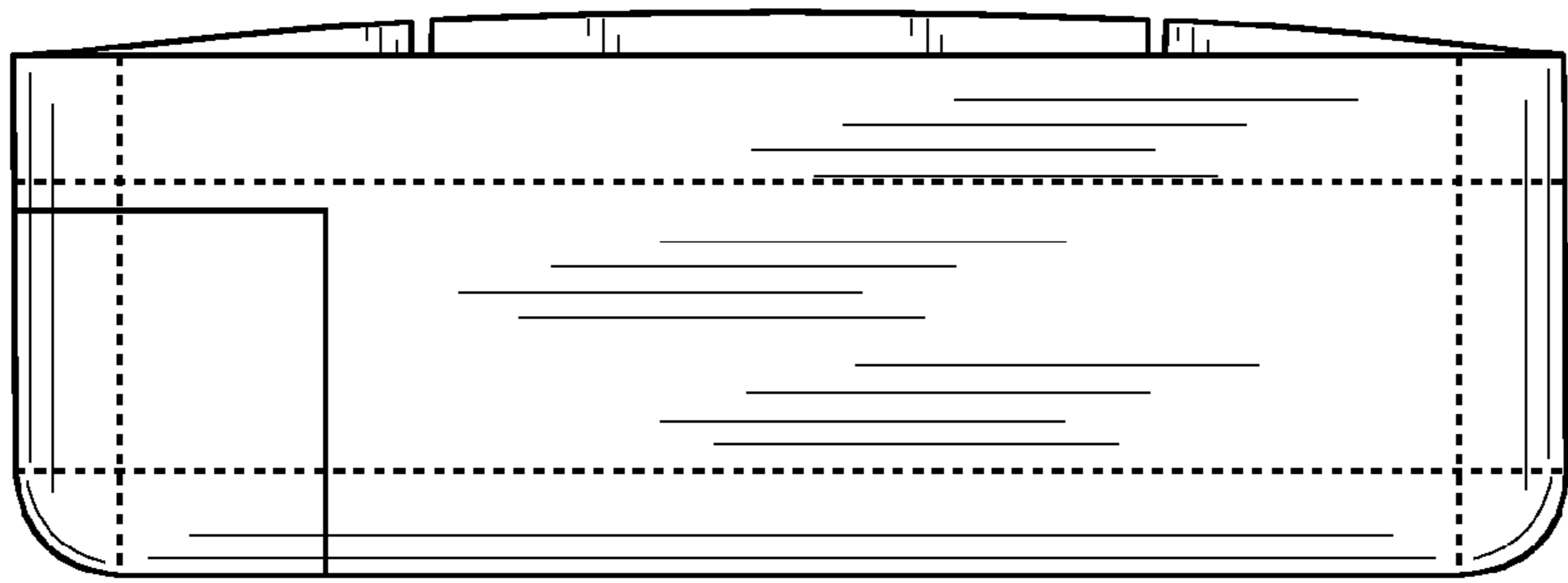
**FIG. 2**



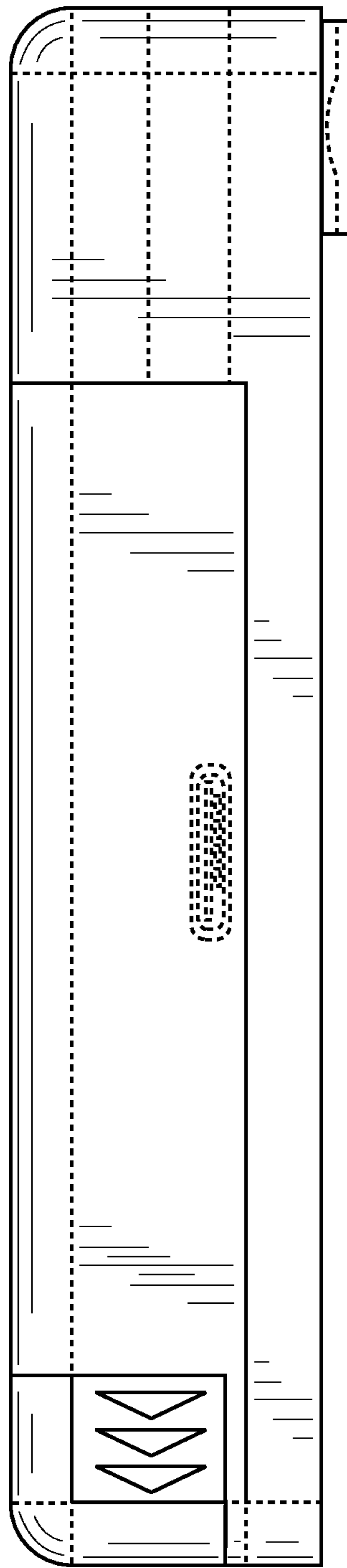
**FIG. 3**



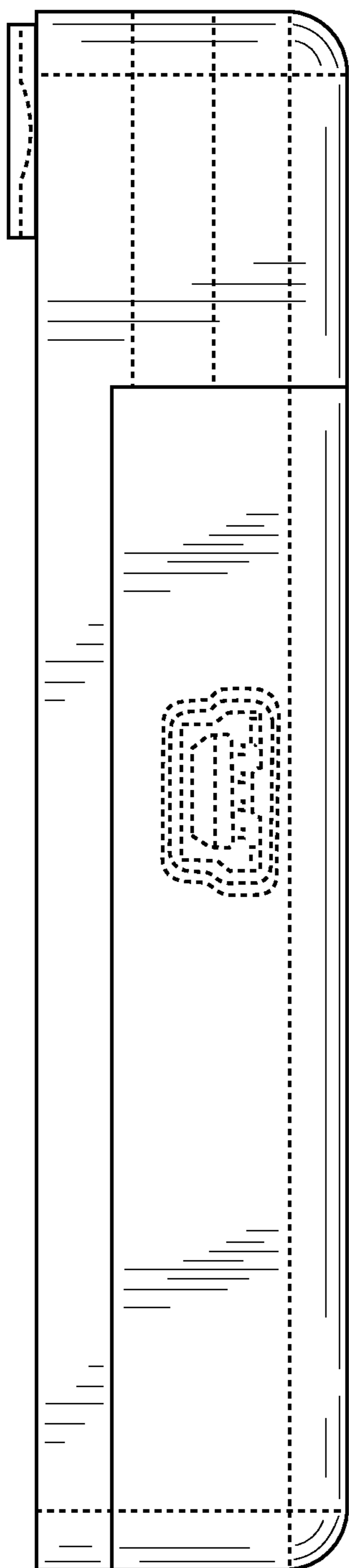
**FIG. 4**



**FIG. 5**



**FIG. 6**



**FIG. 7**