



US00D693436S

(12) **United States Design Patent**
Starck

(10) **Patent No.:** **US D693,436 S**

(45) **Date of Patent:** **** Nov. 12, 2013**

(54) **WALL-MOUNTED SHOWER UNIT**

FOREIGN PATENT DOCUMENTS

(75) Inventor: **Philippe Starck**, Paris (FR)

EM 000114103-0001 12/2003

EM 000114103-0002 12/2003

(73) Assignee: **Hansgrohe SE**, Schiltach (DE)

EM 000125000-0005 1/2004

EM 000125000-0006 1/2004

(**) Term: **14 Years**

* cited by examiner

(21) Appl. No.: **29/431,633**

Primary Examiner — Robert Delehanty

(74) *Attorney, Agent, or Firm* — Nirav D. Parikh

(22) Filed: **Sep. 10, 2012**

(30) **Foreign Application Priority Data**

Mar. 16, 2012 (EM) 001318273-0032

(51) **LOC (9) Cl.** **23-01**

(52) **U.S. Cl.**
USPC **D23/238**

(58) **Field of Classification Search**
USPC D23/238–243, 249–250, 255, 257;
4/675–678; 138/801
See application file for complete search history.

(56) **References Cited**

U.S. PATENT DOCUMENTS

D438,597 S * 3/2001 Gottwald et al. D23/238
D560,761 S * 1/2008 Heck et al. D23/238
D667,087 S * 9/2012 Shieh D23/239

(57) **CLAIM**

The ornamental design for a wall-mounted shower unit, as shown and described.

DESCRIPTION

FIG. 1 is a perspective view of a wall-mounted shower unit showing my design;

FIG. 2 is a front elevational view thereof;

FIG. 3 is a rear elevational view thereof;

FIG. 4 is a left side elevational view thereof;

FIG. 5 is a right side elevational view thereof;

FIG. 6 is a top plan view thereof; and,

FIG. 7 is a bottom plan view thereof.

The broken-line disclosure in the views represents portions of the article in which the claimed design is embodied, but which form no part of the claimed design.

1 Claim, 7 Drawing Sheets

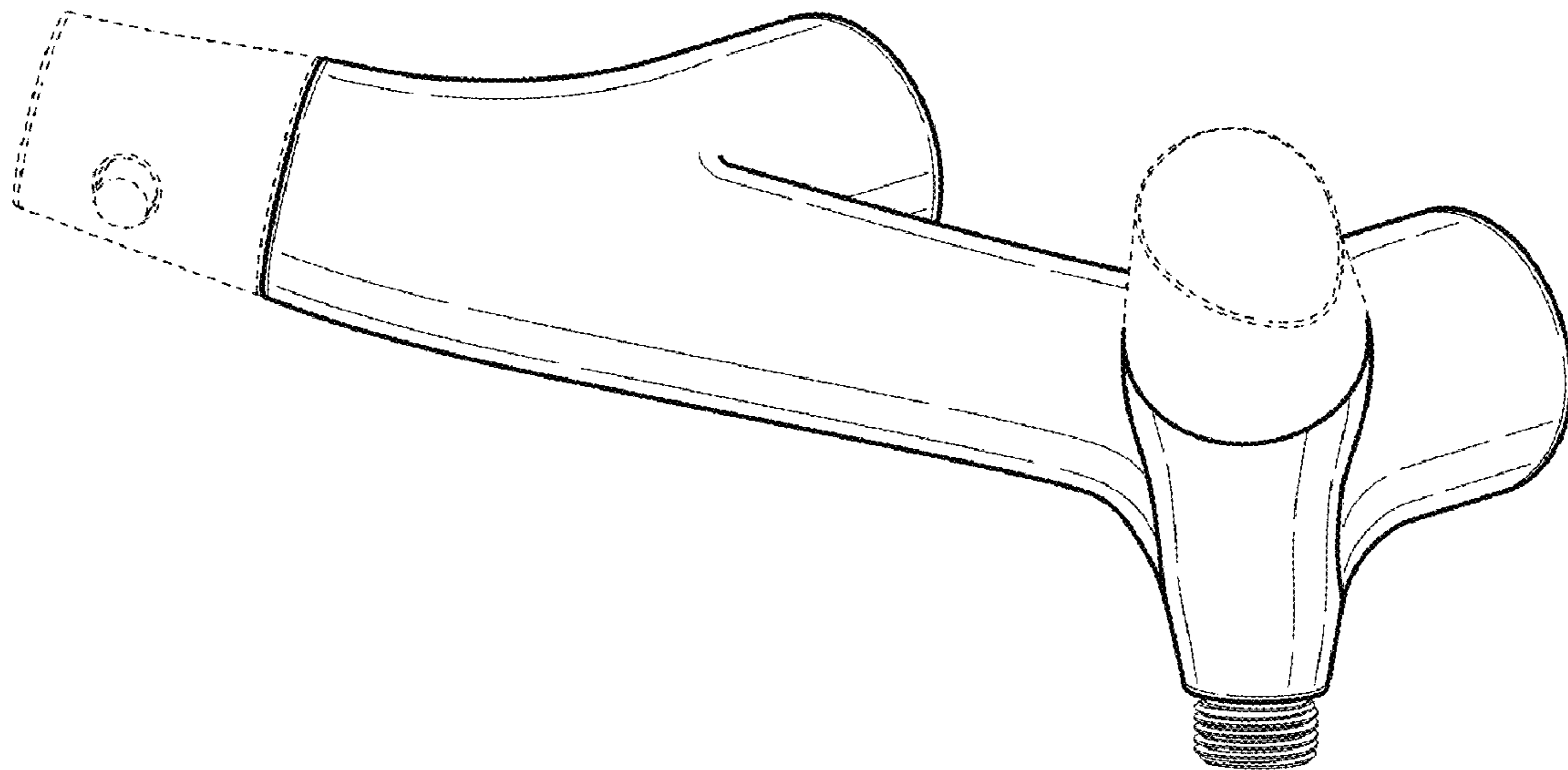

FIG. 1

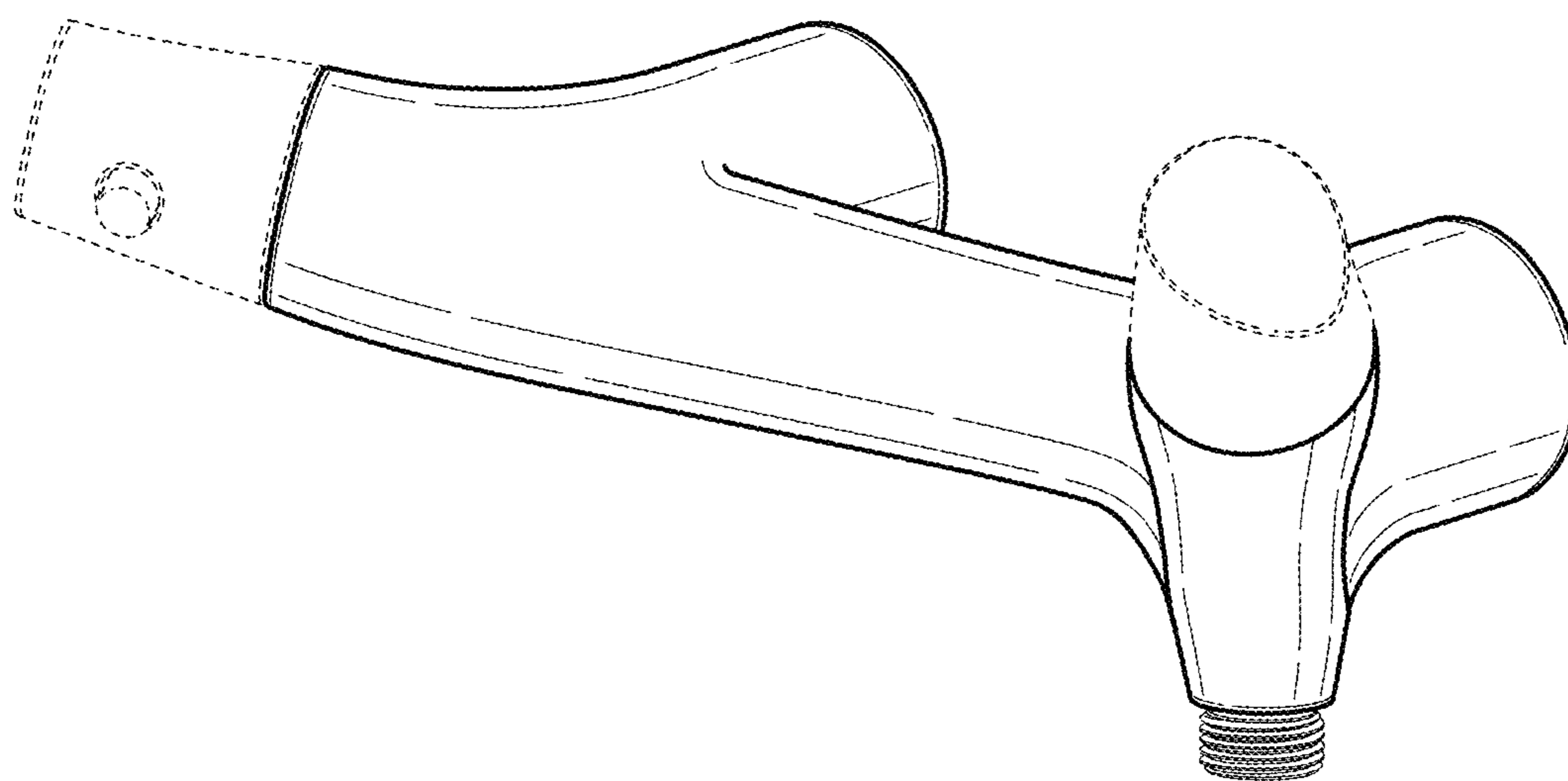

FIG. 2

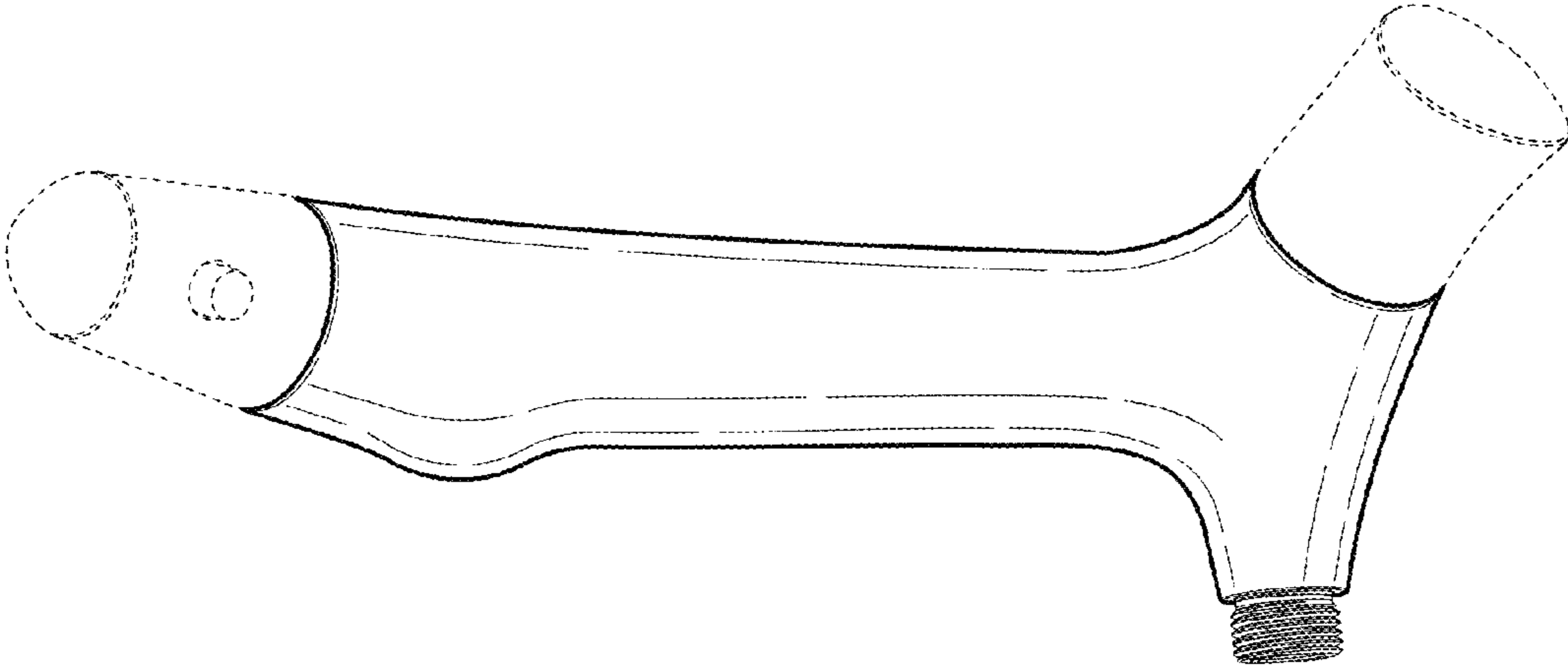

FIG. 3

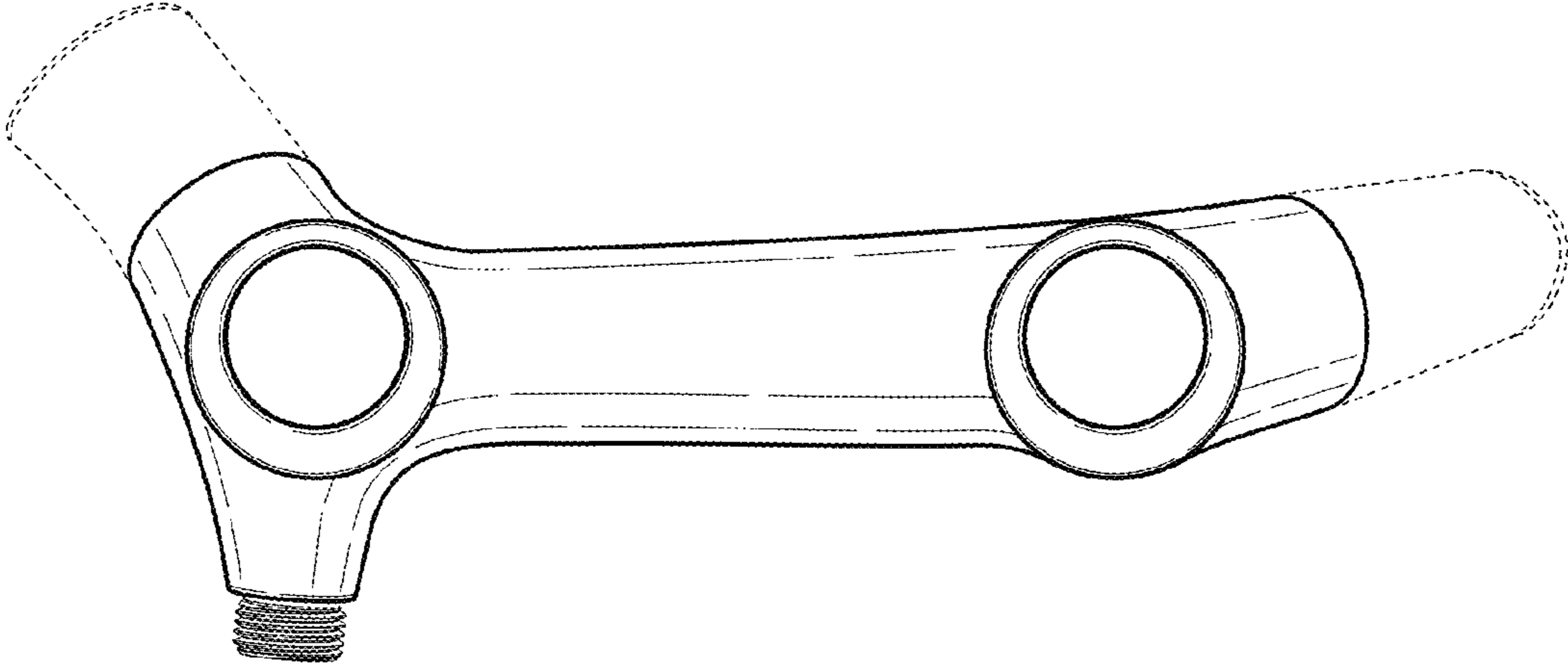

FIG. 4

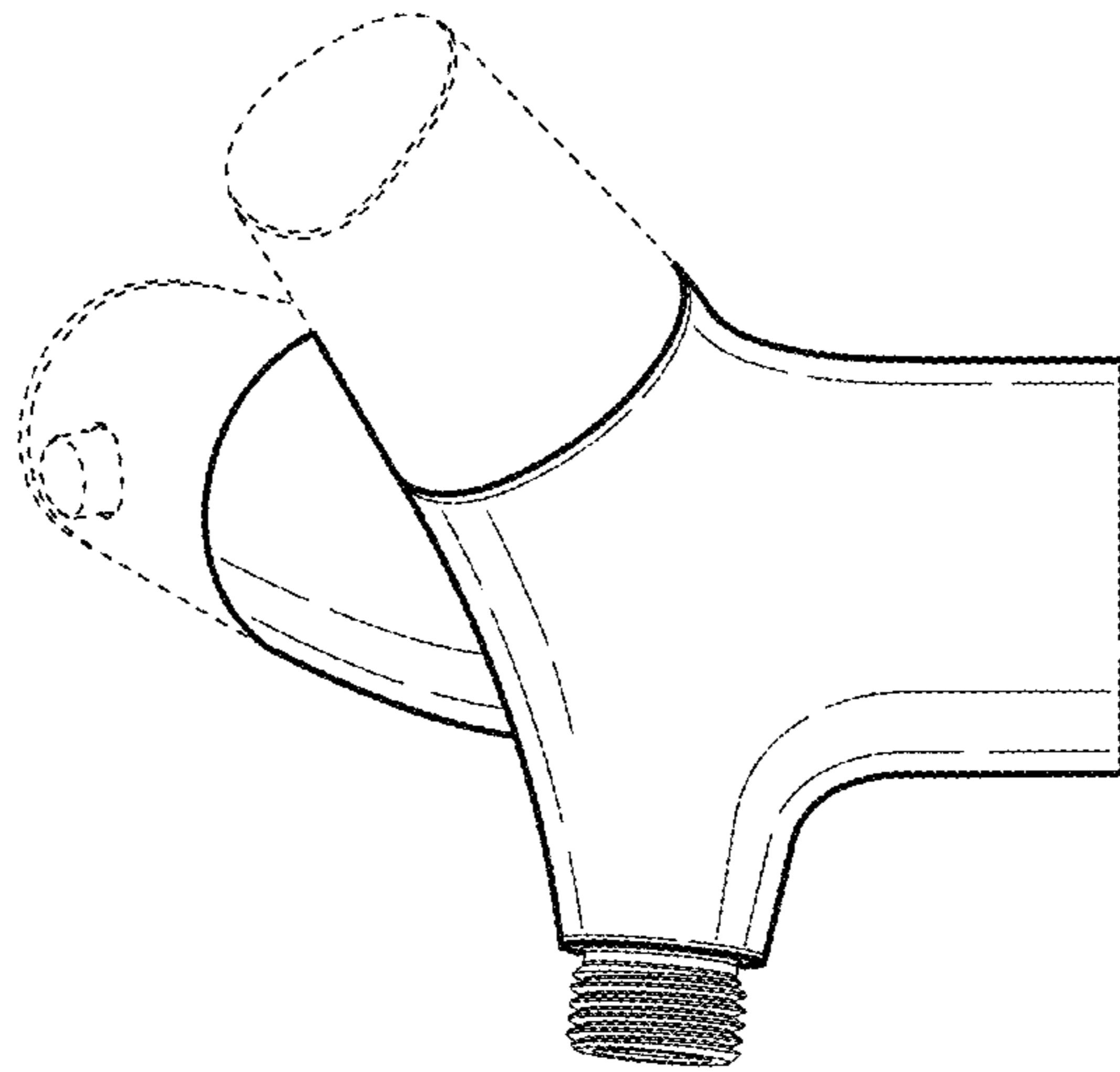

FIG. 5

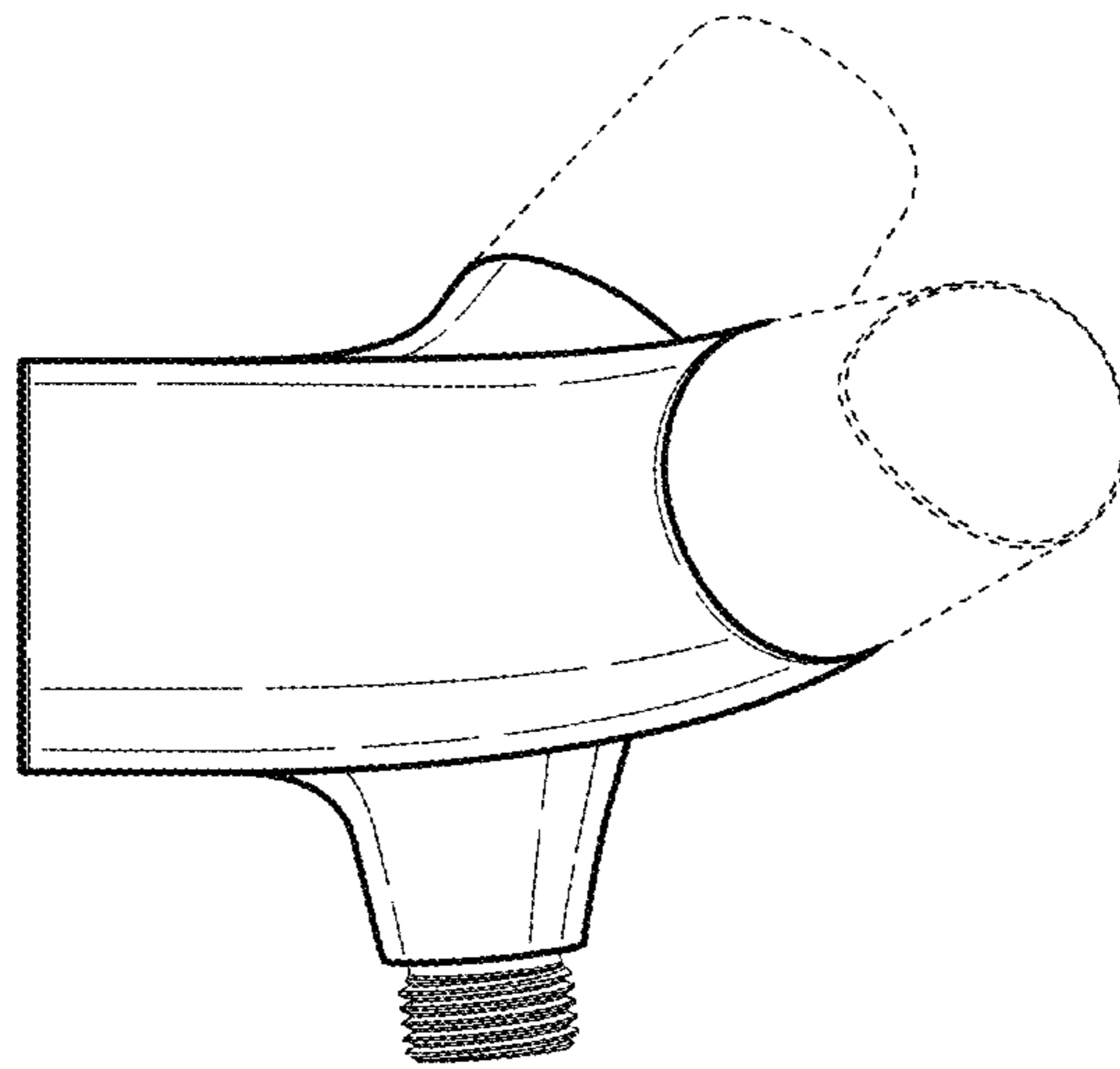

FIG. 6

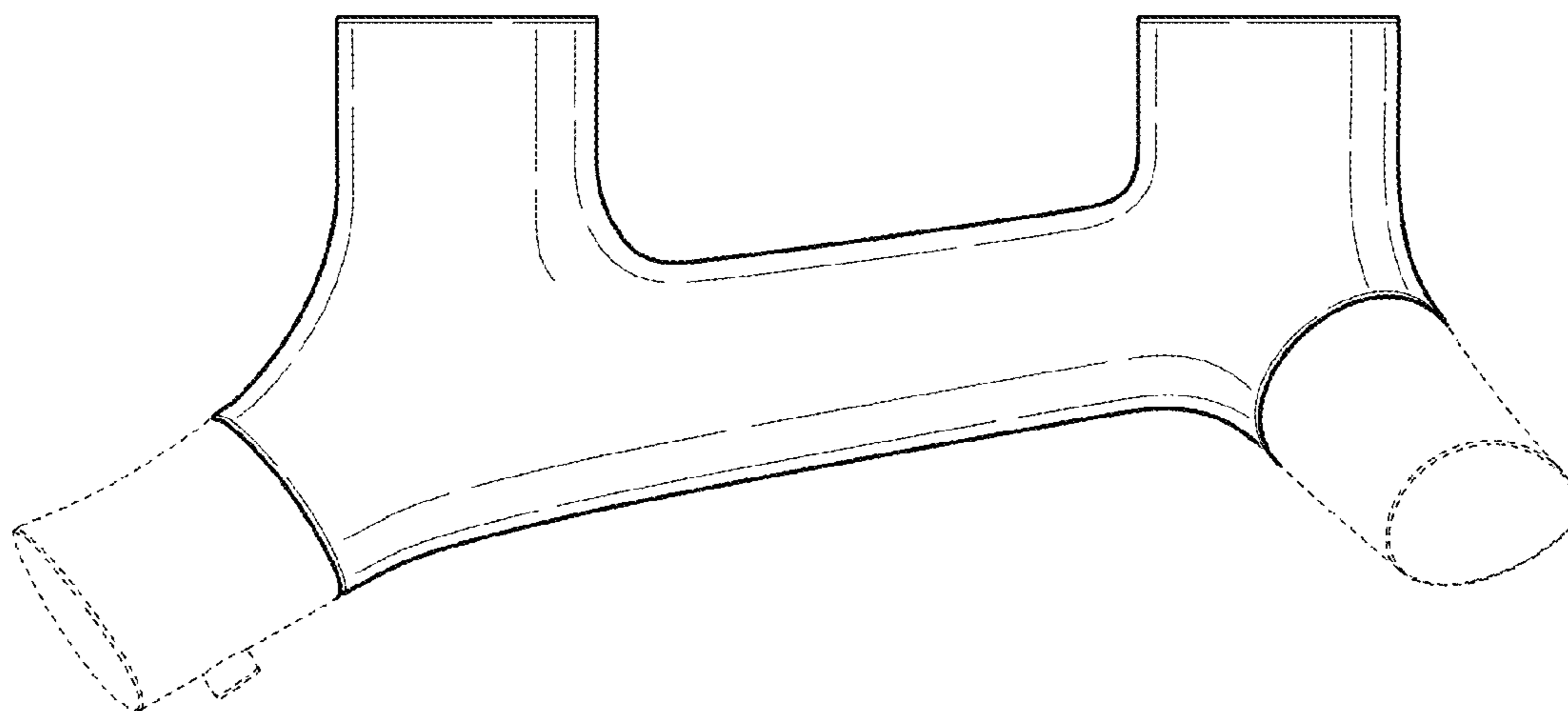

FIG. 7

