



US00D693398S

(12) **United States Design Patent**
Rubin

(10) **Patent No.:** **US D693,398 S**

(45) **Date of Patent:** **** Nov. 12, 2013**

(54) **EYEWEAR**

(71) Applicant: **Wayne L. Rubin**, Hewlett Bay Park, NY
(US)

(72) Inventor: **Wayne L. Rubin**, Hewlett Bay Park, NY
(US)

(**) Term: **14 Years**

(21) Appl. No.: **29/455,822**

(22) Filed: **May 24, 2013**

(51) **LOC (9) Cl.** **16-06**

(52) **U.S. Cl.**

USPC **D16/303**; D16/325

(58) **Field of Classification Search**

USPC D16/101, 300–342, 900; D29/109–110;
351/41, 44, 51–52, 62, 158, 92,
351/103–123, 140–153, 45–46, 63;
2/426–432, 447–449, 441, 434–437,
2/13, 15; D21/483, 659–661; D14/372

See application file for complete search history.

(56) **References Cited**

U.S. PATENT DOCUMENTS

5,448,317 A * 9/1995 Huang 351/158
5,532,766 A * 7/1996 Mateer et al. 351/63

6,783,236 B2 * 8/2004 Chou 351/63
7,033,020 B2 * 4/2006 Sawhney 351/63
RE40,108 E * 2/2008 Kuo 351/63
7,905,591 B2 * 3/2011 Strobel 351/63

* cited by examiner

Primary Examiner — Raphael Barkai

(74) *Attorney, Agent, or Firm* — F. Chau & Associates, LLC

(57) **CLAIM**

The ornamental design for eyewear, as shown and described.

DESCRIPTION

FIG. 1 is a top front perspective view showing eyewear having the design of the invention in a unfolded orientation;
FIG. 2 is a bottom rear perspective view of the eyewear shown in FIG. 1;
FIG. 3 is a top plan view of the eyewear shown in FIG. 1;
FIG. 4 is a bottom plan view of the eyewear shown in FIG. 1;
FIG. 5 is a right side view of the eyewear shown in FIG. 1;
FIG. 6 is a front view of the eyewear shown in FIG. 1;
FIG. 7 is a rear view of the eyewear shown in FIG. 1;
FIG. 8 is a top front perspective view showing the eyewear of FIG. 1 in an folded orientation; and,
FIG. 9 is a top plan view of the eyewear shown in FIG. 8.

1 Claim, 5 Drawing Sheets

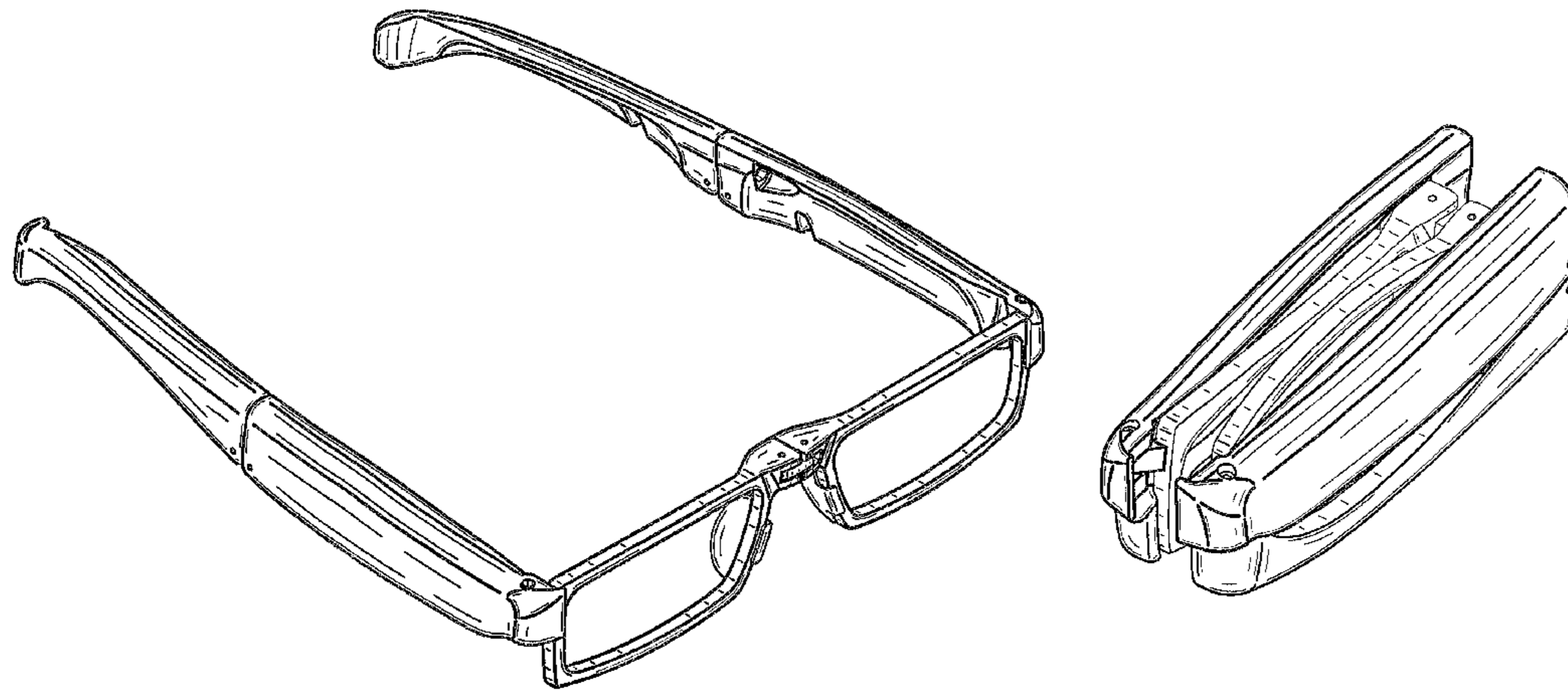

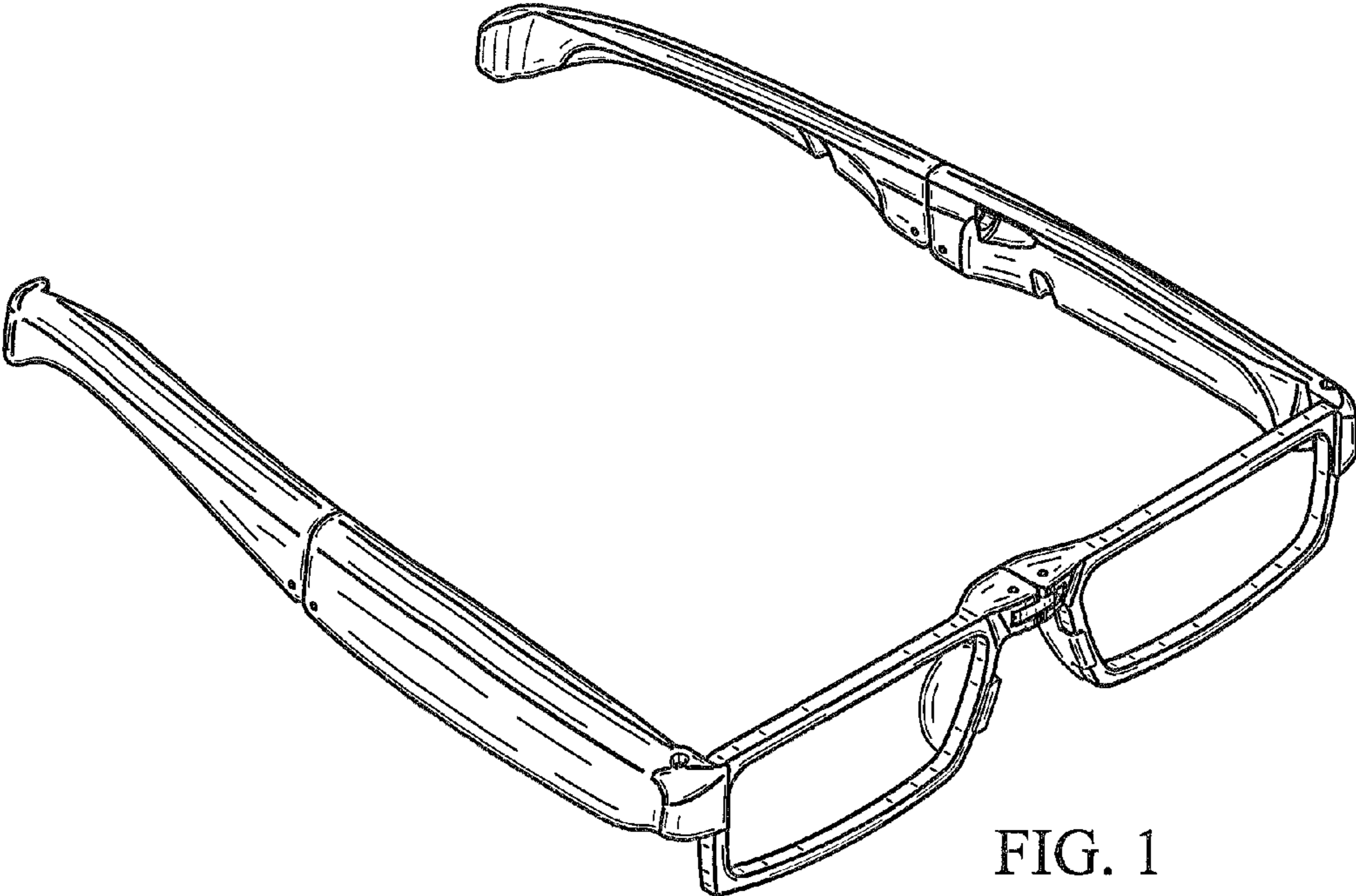

FIG. 1

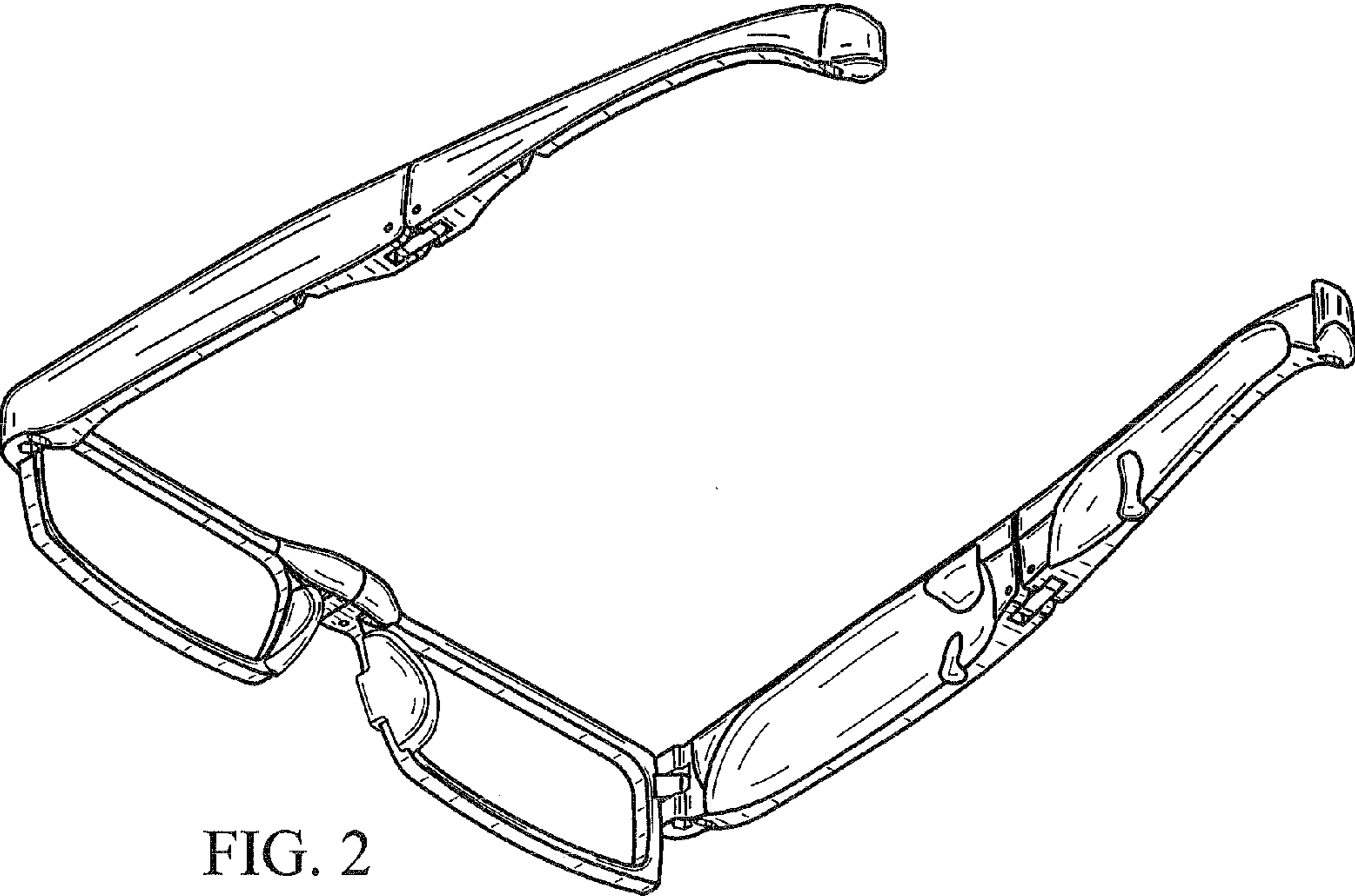

FIG. 2

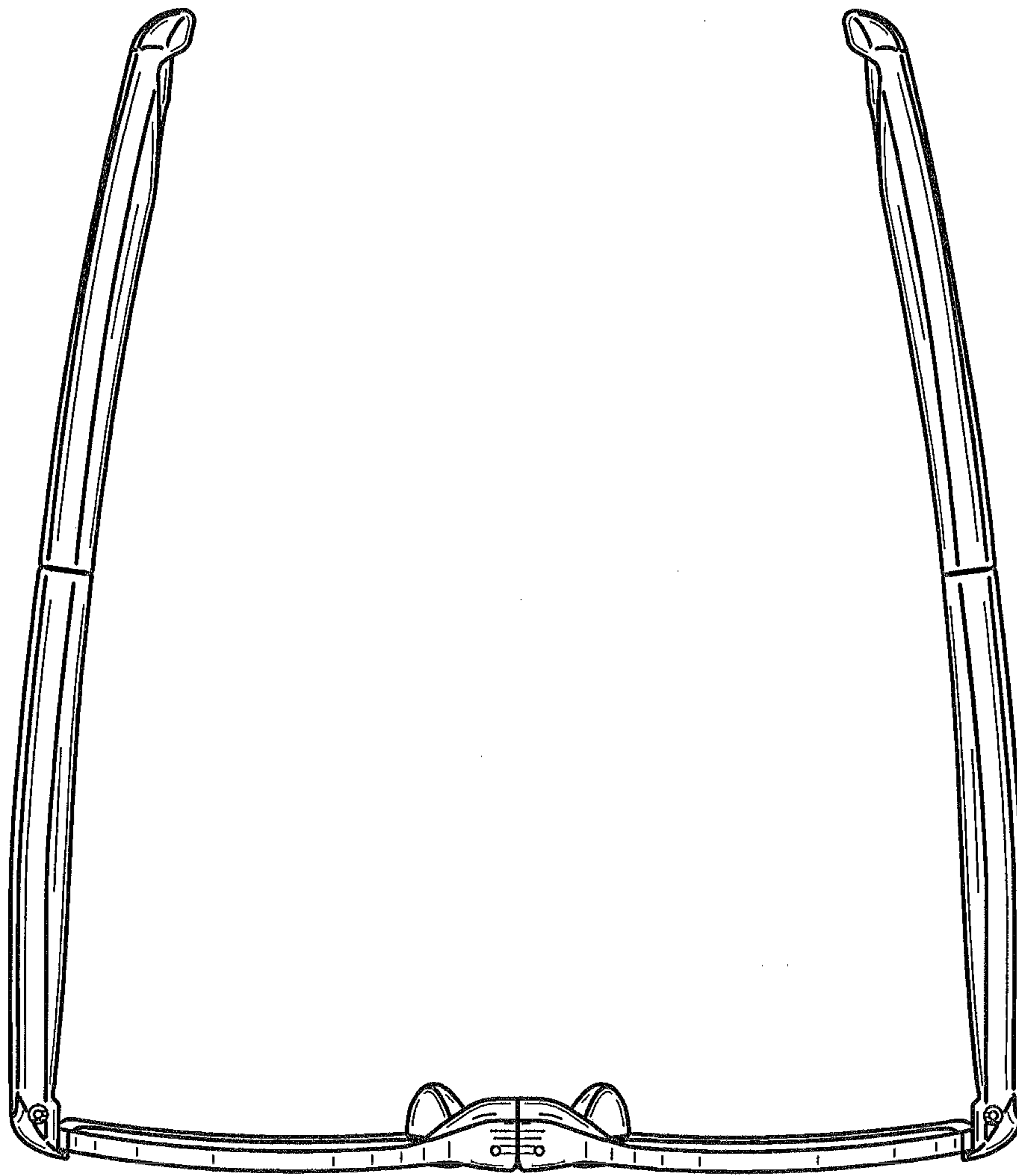

FIG. 3

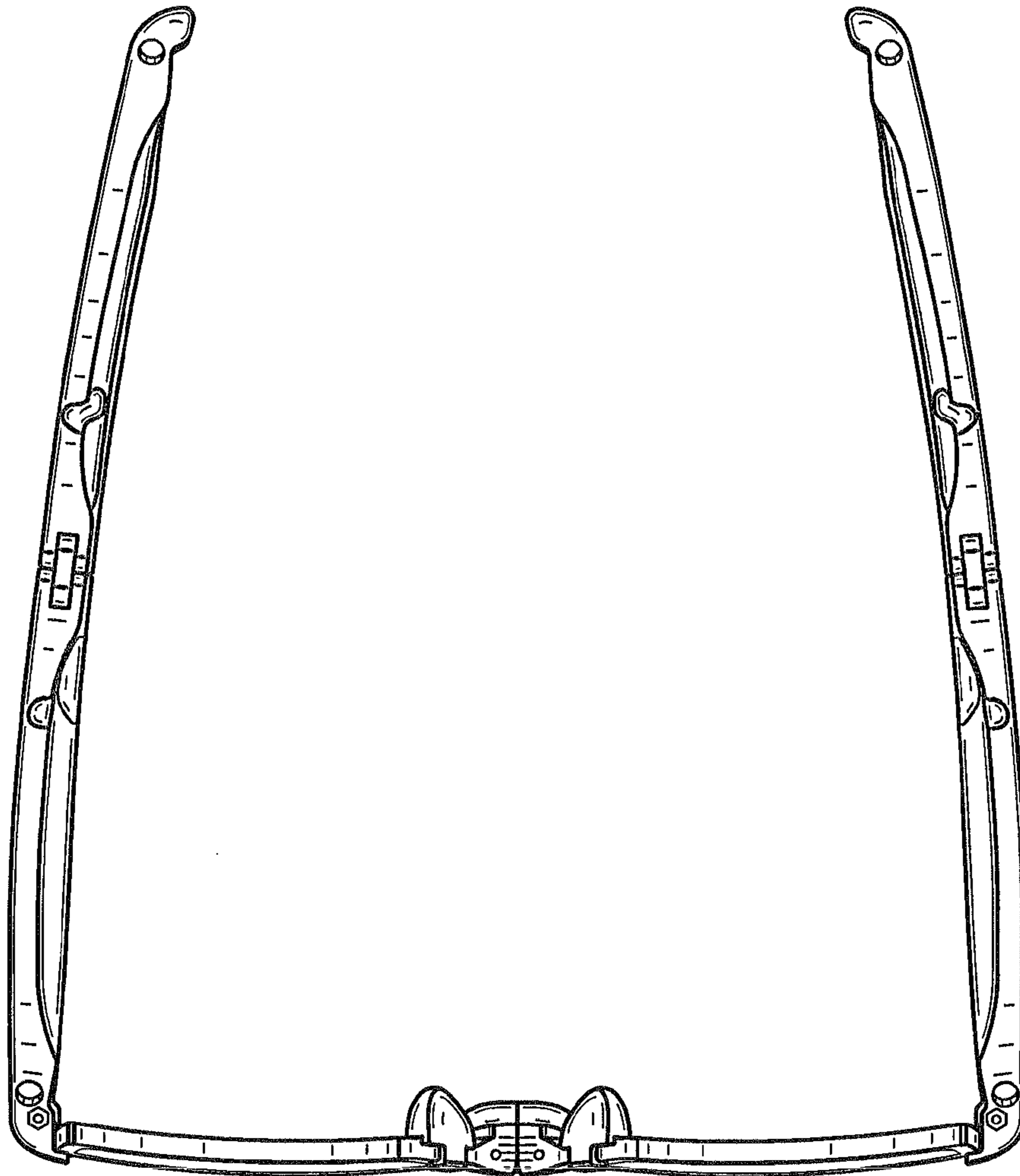

FIG. 4

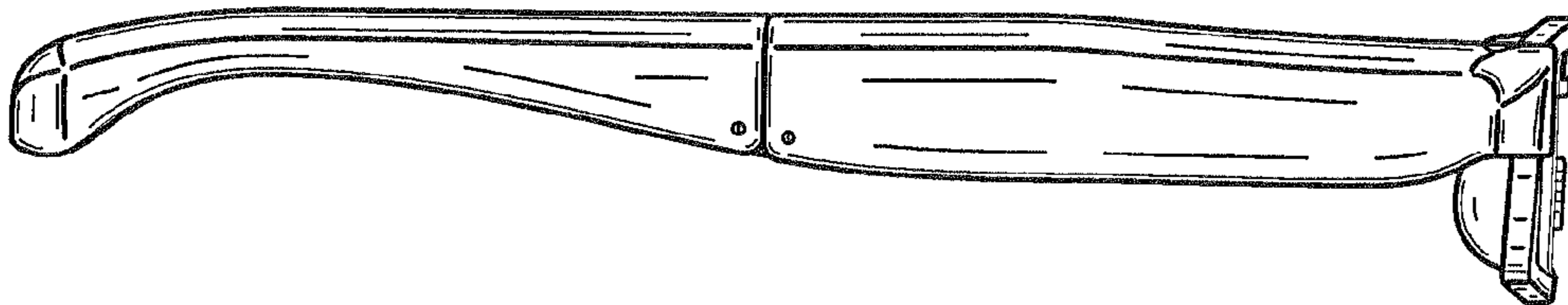

FIG. 5

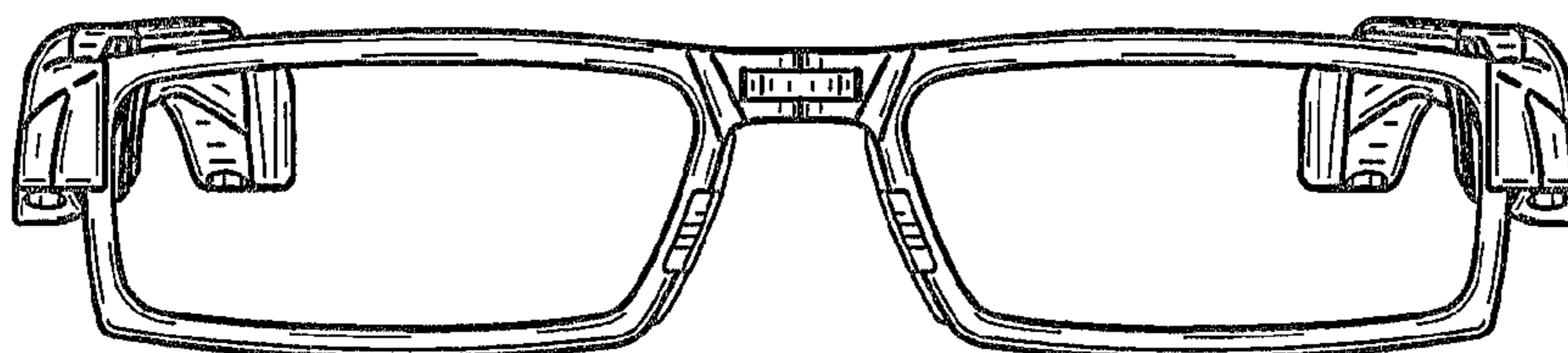

FIG. 6

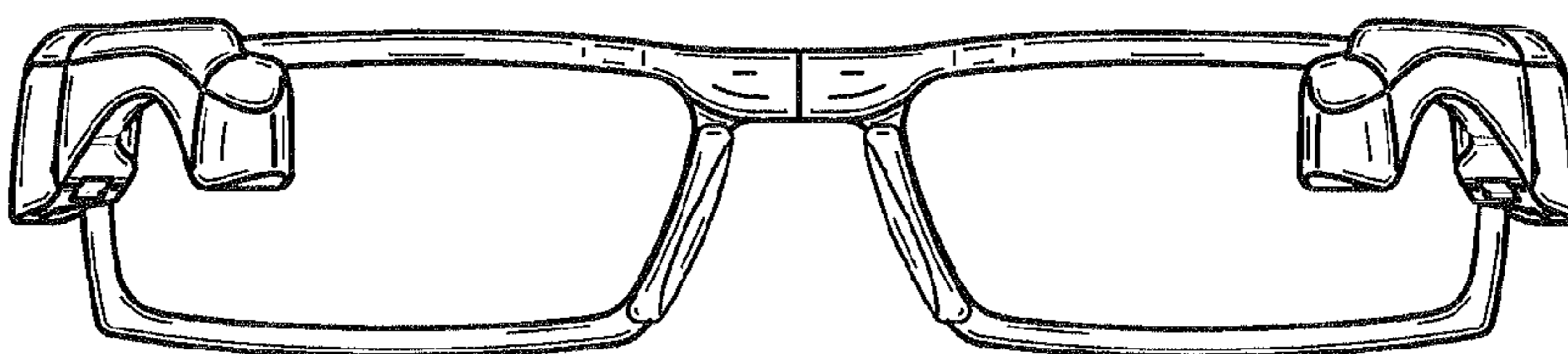

FIG. 7

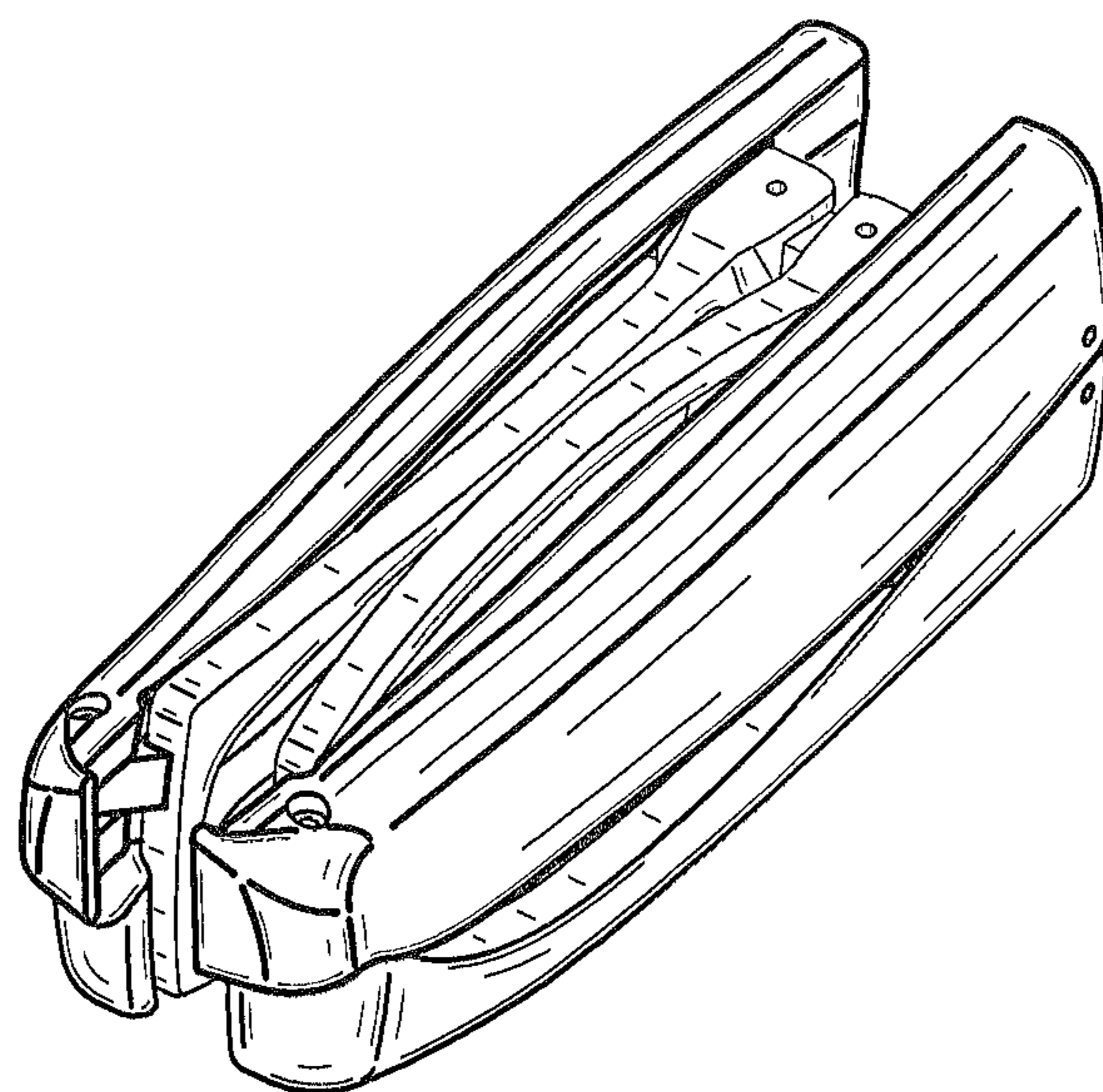

FIG. 8

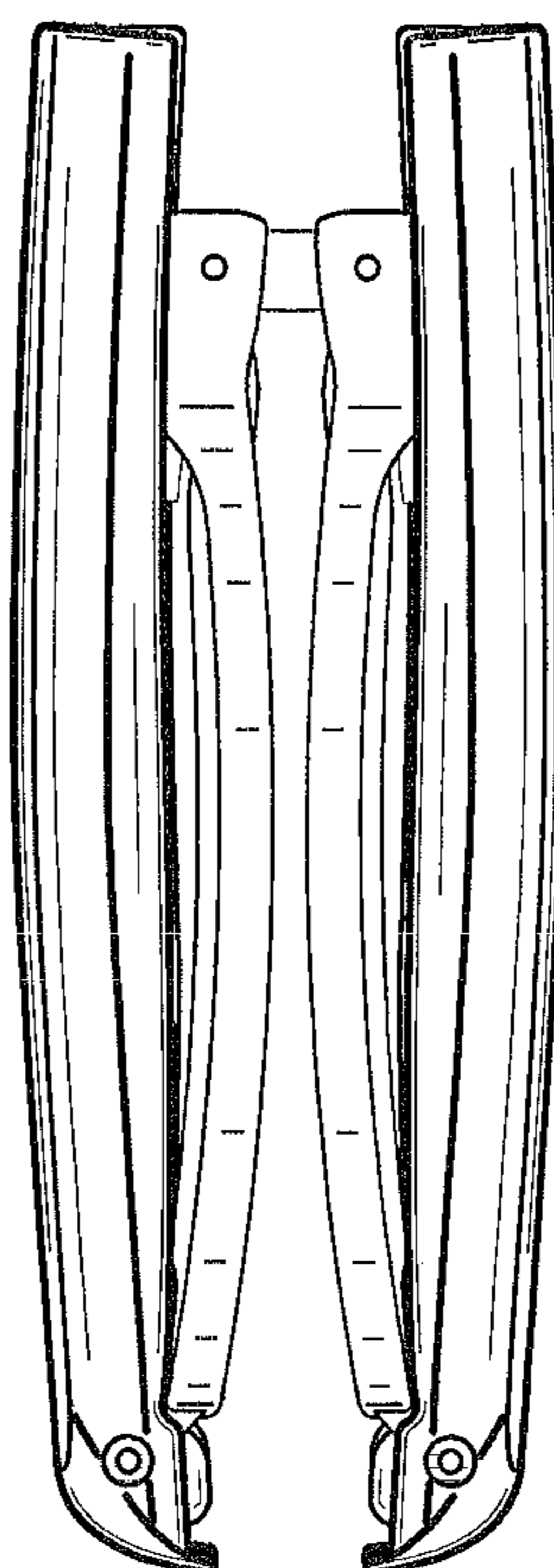

FIG. 9