



US00D693394S

(12) **United States Design Patent**  
**Linne et al.**

(10) **Patent No.:** **US D693,394 S**

(45) **Date of Patent:** **\*\* Nov. 12, 2013**

(54) **MIXER**

(75) Inventors: **Volker Linne**, Frümsen (CH); **Andreas Hiemer**, Schübelbach (CH); **David Tobler**, Winterhur (CH)

(73) Assignee: **Sulzer Mixpac AG**, Haag (CH)

(\*\*) Term: **14 Years**

(21) Appl. No.: **29/413,778**

(22) Filed: **Feb. 21, 2012**

(51) **LOC (9) Cl.** ..... **15-99**

(52) **U.S. Cl.**  
USPC ..... **D15/147**

(58) **Field of Classification Search**  
USPC ..... D7/376, 384; D15/135, 136, 137, 199;  
277/26 R, 95; 366/47, 48, 57, 60, 63,  
366/65, 76.7, 143, 149, 168.1, 181.3, 185,  
366/192, 193, 217, 219, 228, 232, 241-260,  
366/309, 326.1, 601, 604, 605  
See application file for complete search history.

(56) **References Cited**

**U.S. PATENT DOCUMENTS**

D343,458 S *	1/1994	Mechler et al.	.....	D24/220
D346,223 S *	4/1994	Mechler et al.	.....	D24/220
D394,072 S *	5/1998	McAvinney et al.	.....	D15/148
7,311,436 B2 *	12/2007	Barker et al.	.....	366/139
D671,968 S *	12/2012	Schmidt	.....	D15/122
2001/0024400 A1 *	9/2001	Van Der Wel	.....	366/143
2002/0118596 A1 *	8/2002	Mizutani et al.	.....	366/189
2006/0018187 A1 *	1/2006	Donna et al.	.....	366/129

2006/0087913 A1 *	4/2006	Leong	.....	366/206
2008/0056061 A1 *	3/2008	Pauser et al.	.....	366/152.2
2013/0058184 A1 *	3/2013	Hansen	.....	366/138

\* cited by examiner

*Primary Examiner* — Patricia Palasik

(74) *Attorney, Agent, or Firm* — K&L Gates LLP

(57) **CLAIM**

The ornamental design for a mixer, as shown and described.

**DESCRIPTION**

FIG. 1 illustrates a top perspective view of the mixer showing our new design;  
 FIG. 2 illustrates a bottom perspective view thereof;  
 FIG. 3 illustrates a front elevation view thereof;  
 FIG. 4 illustrates a back elevation view thereof;  
 FIG. 5 illustrates a left side elevation view thereof;  
 FIG. 6 illustrates a right side elevation view thereof;  
 FIG. 7 illustrates a side perspective view thereof;  
 FIG. 8 illustrates a top perspective view of another embodiment of the mixer showing our design;  
 FIG. 9 illustrates a bottom perspective view of the mixer of FIG. 8;  
 FIG. 10 illustrates a front elevation view of the mixer of FIG. 8;  
 FIG. 11 illustrates a back elevation view of the mixer of FIG. 8;  
 FIG. 12 illustrates a right side elevation view of the mixer of FIG. 8;  
 FIG. 13 illustrates a left side elevation view of the mixer of FIG. 8; and,  
 FIG. 14 illustrates a side perspective view of the mixer of FIG. 8.

**1 Claim, 14 Drawing Sheets**

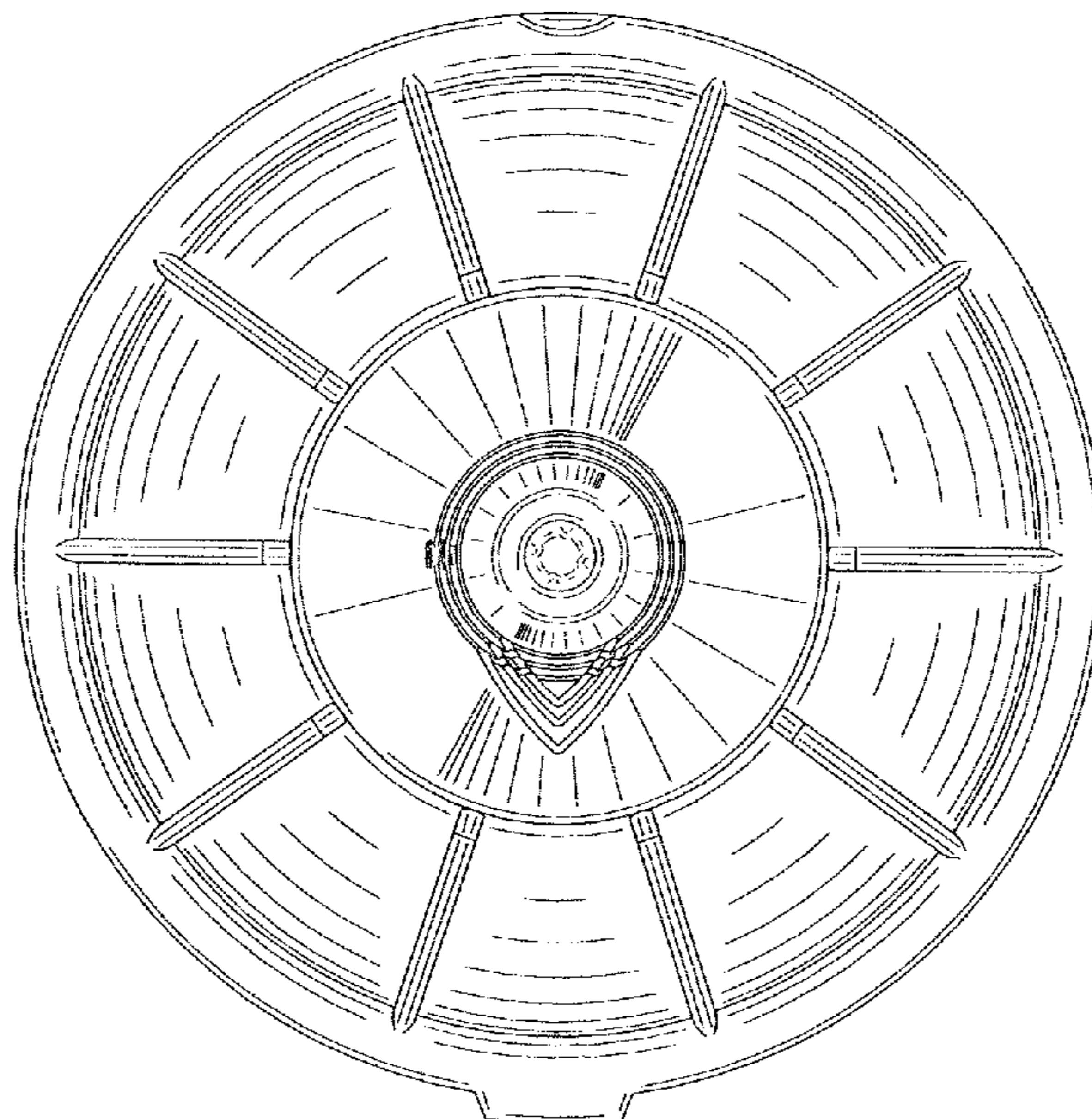

FIG. 1

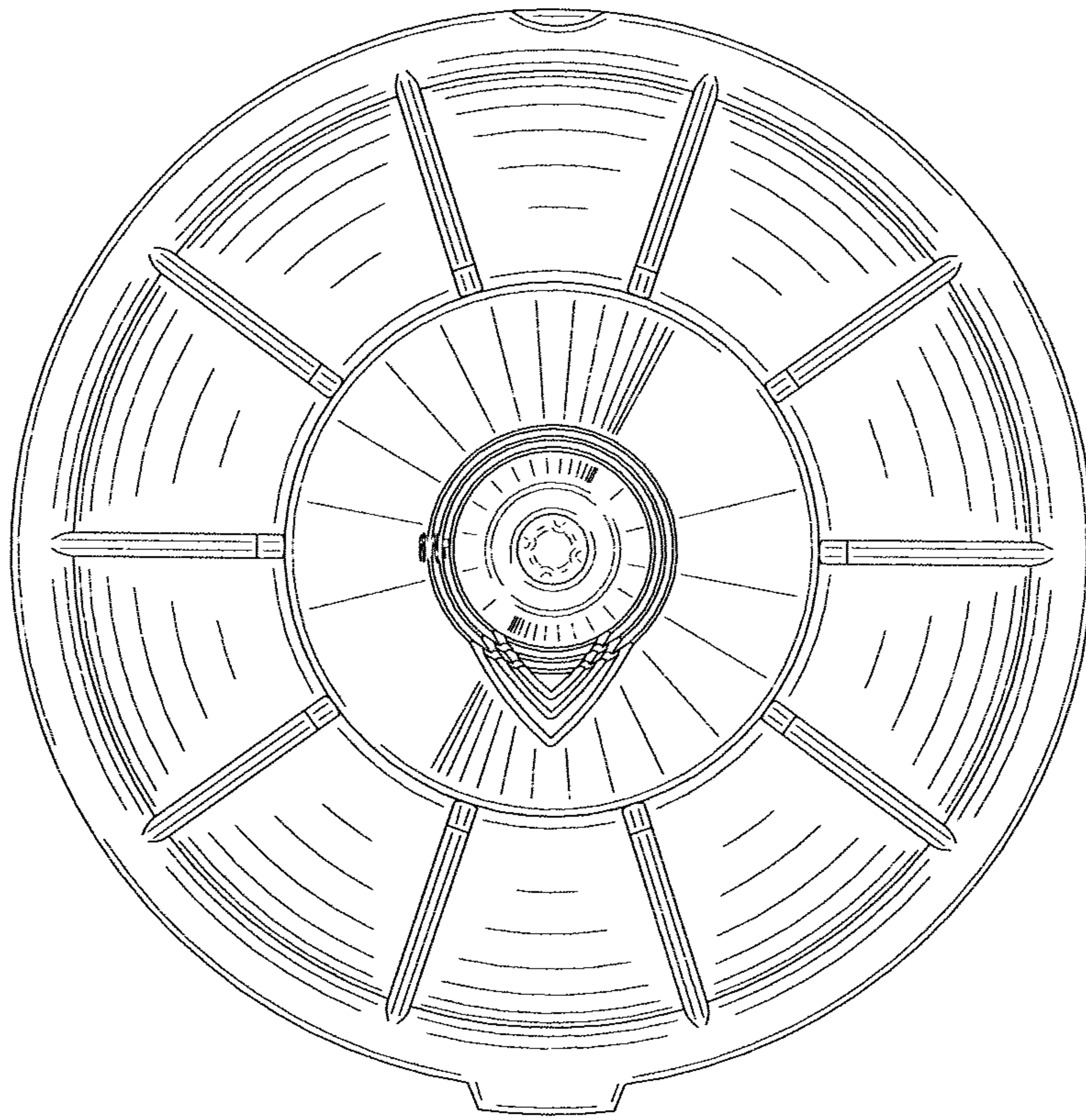

FIG. 2

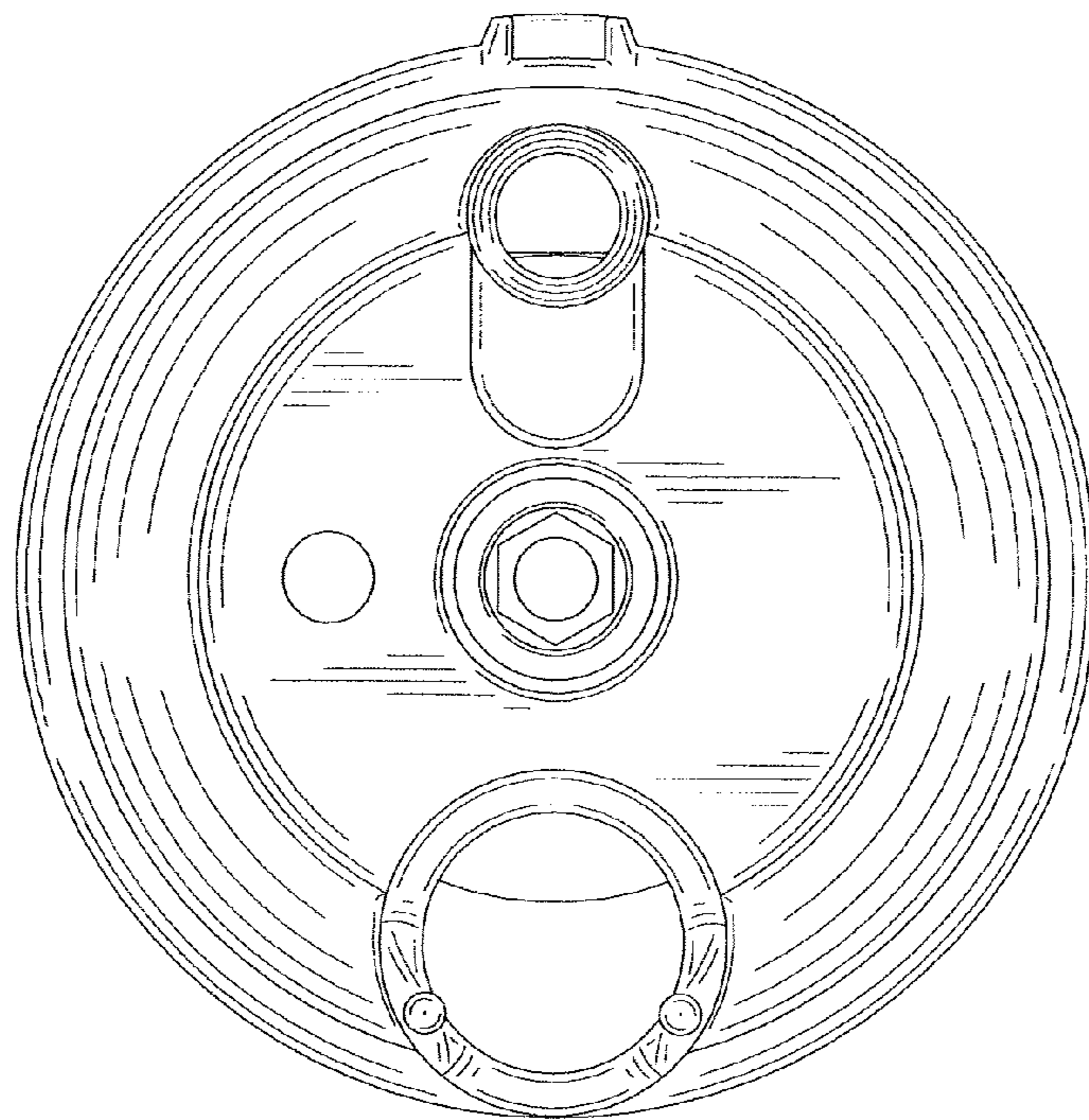

FIG. 3

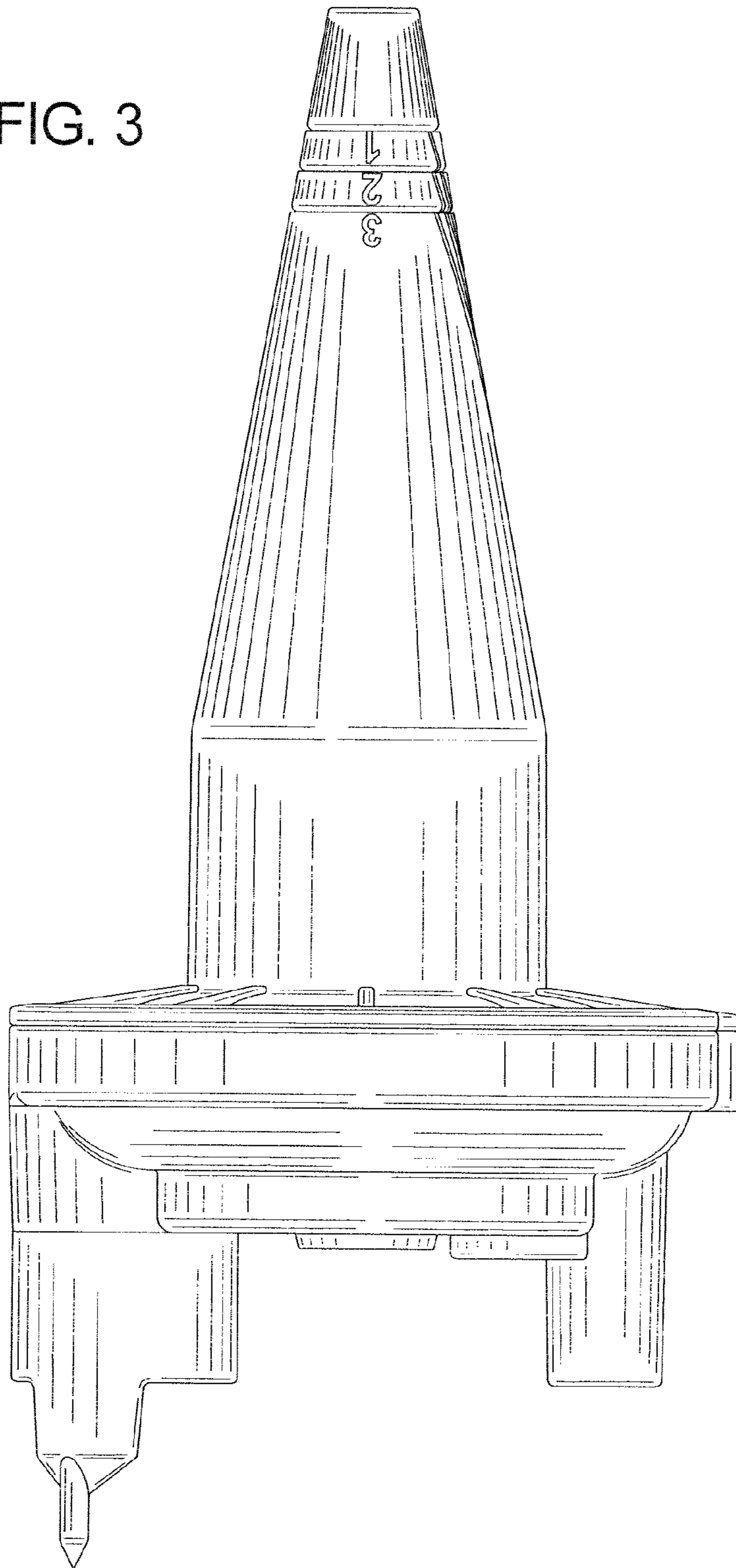

FIG. 4

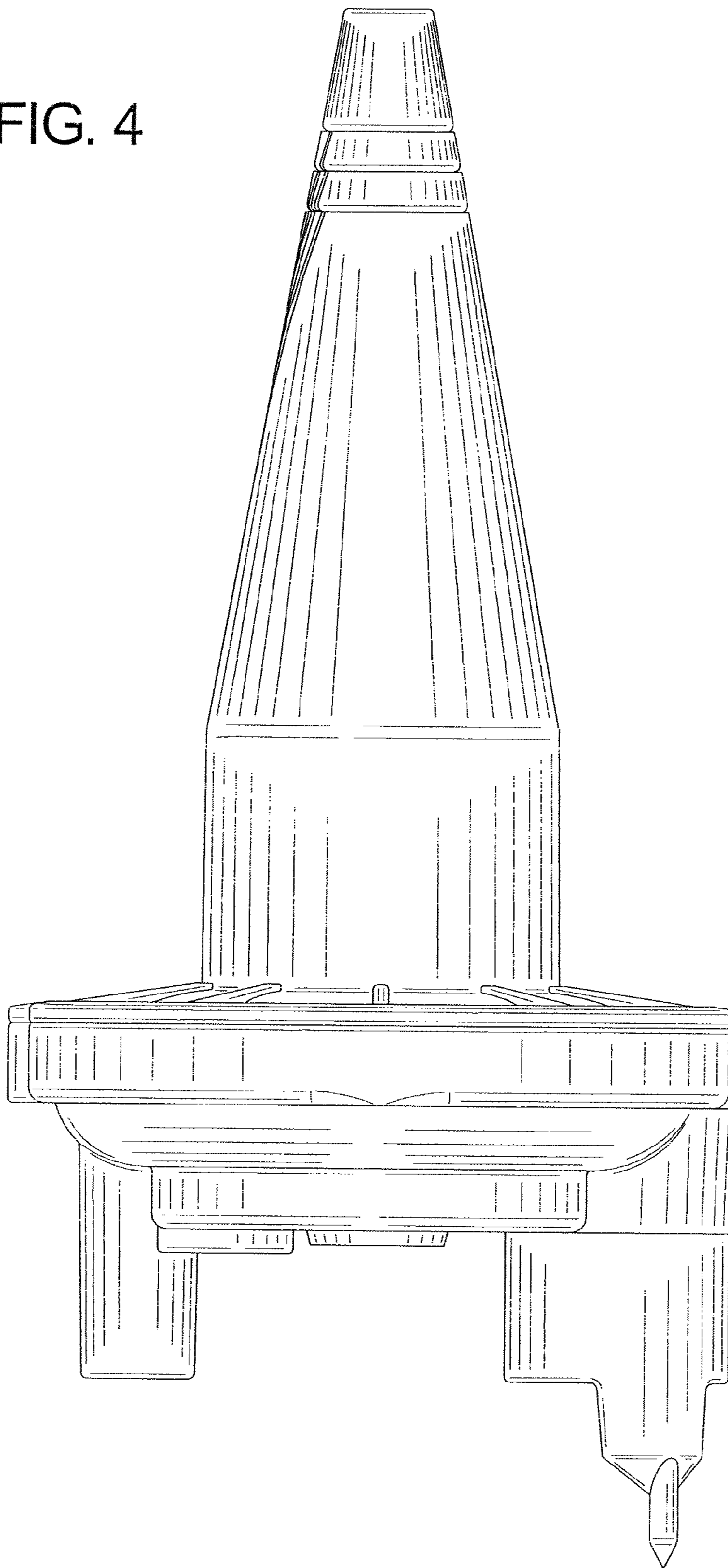

FIG. 5

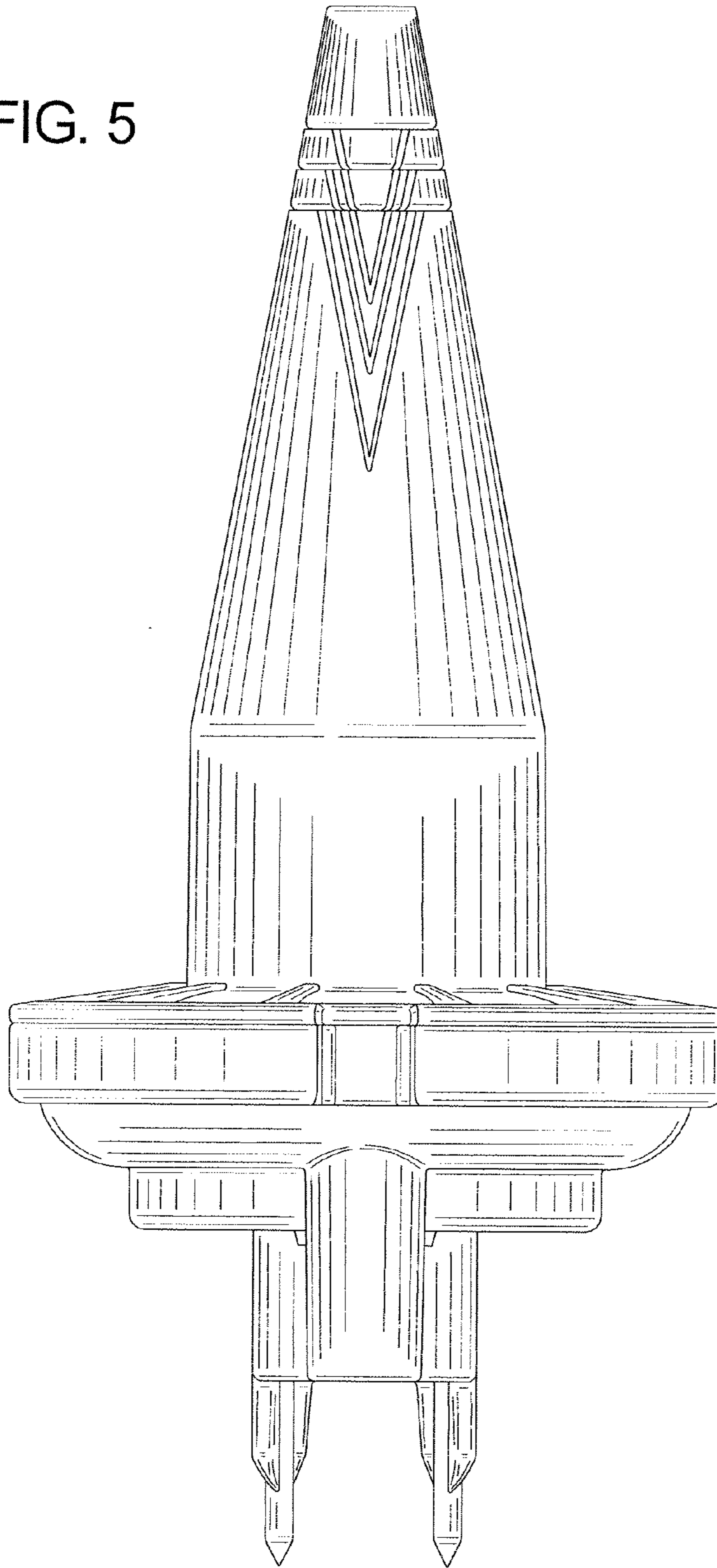

FIG. 6

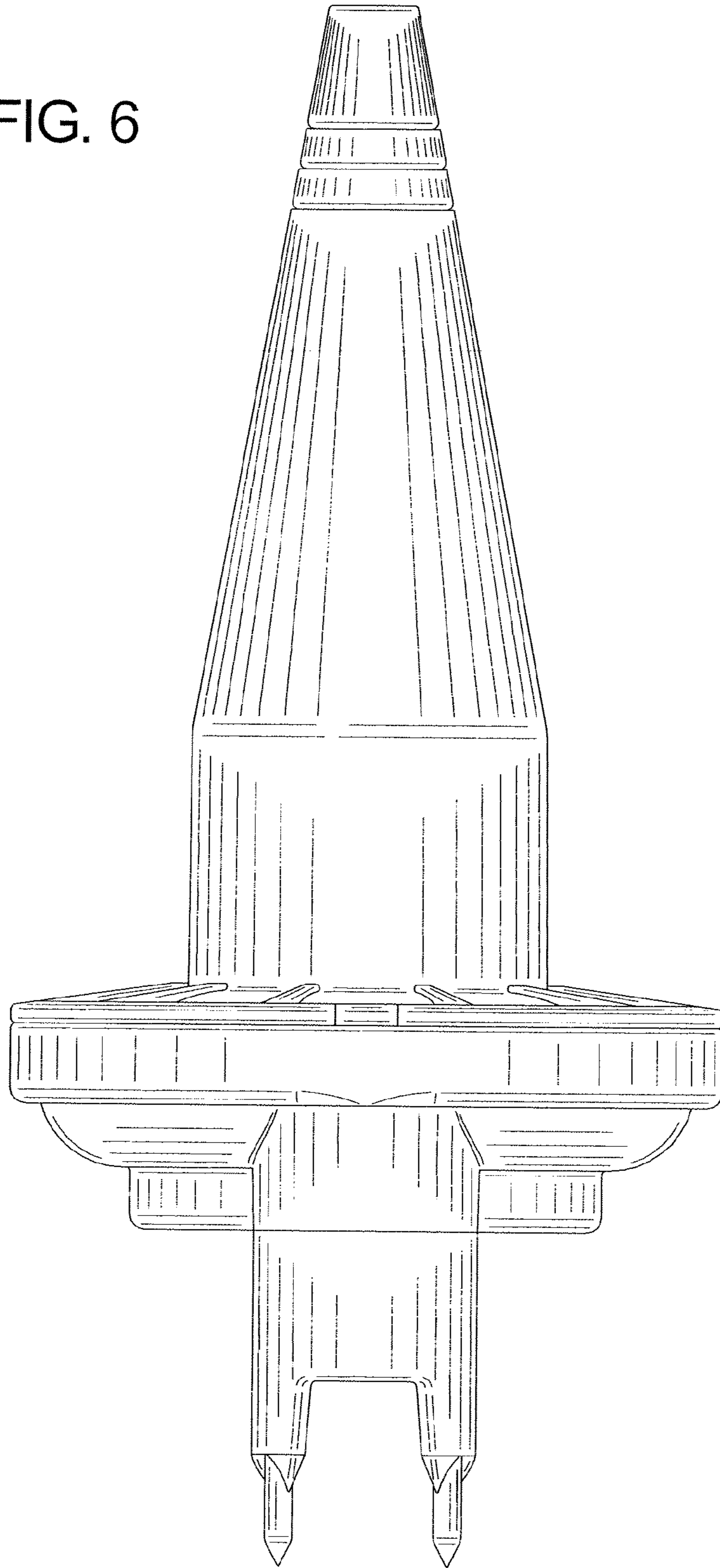

FIG. 7

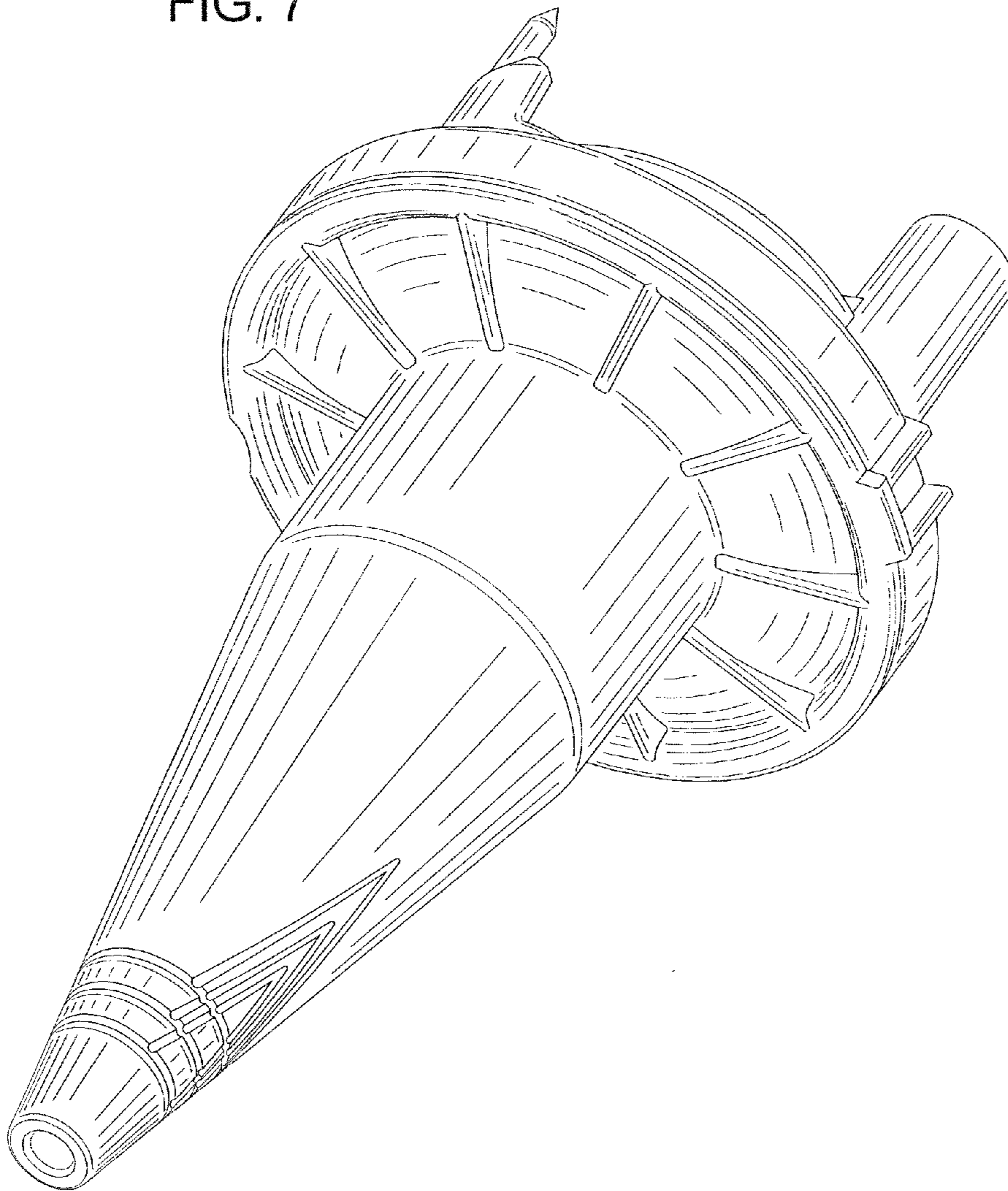



FIG. 8

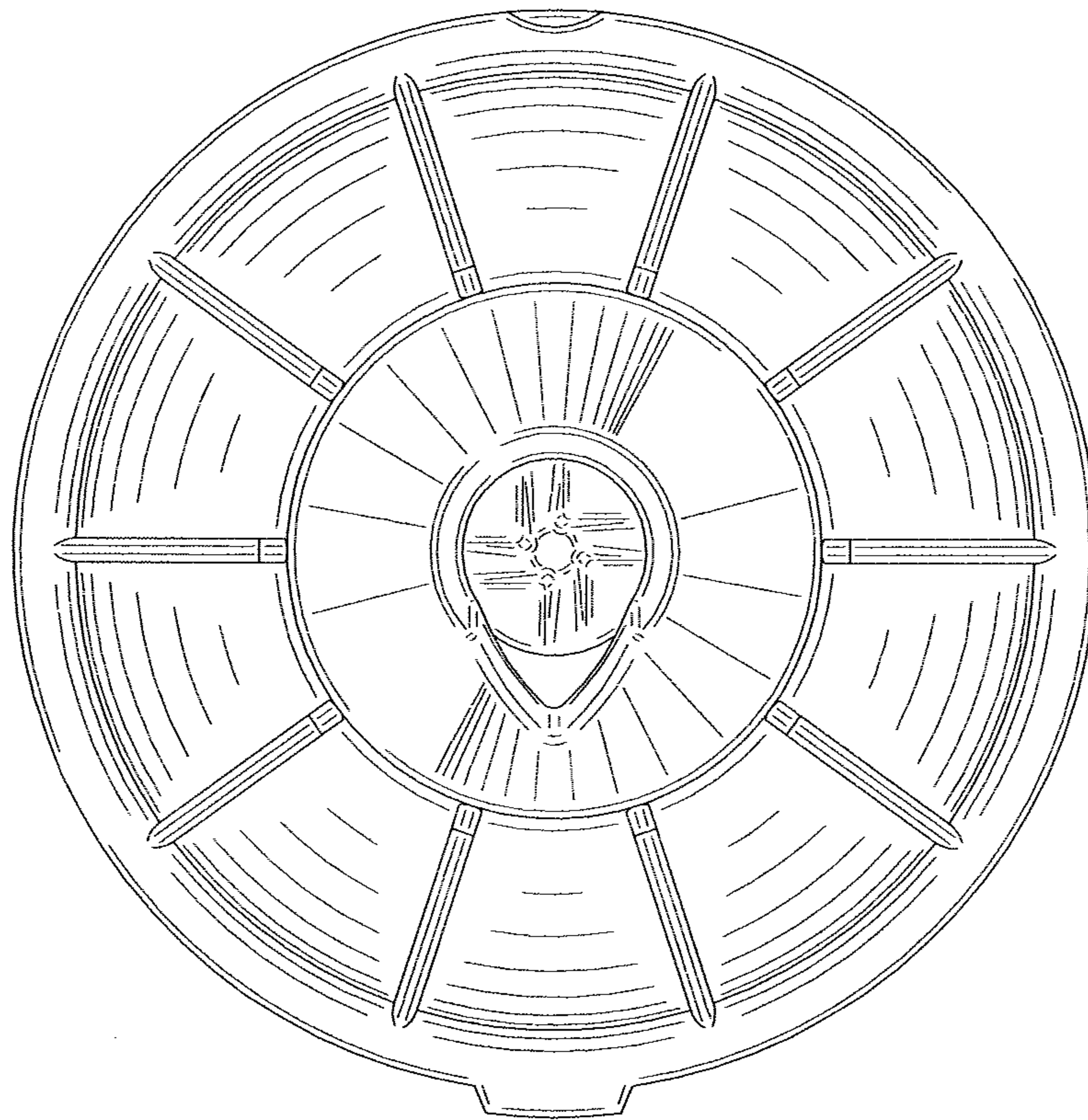

FIG. 9

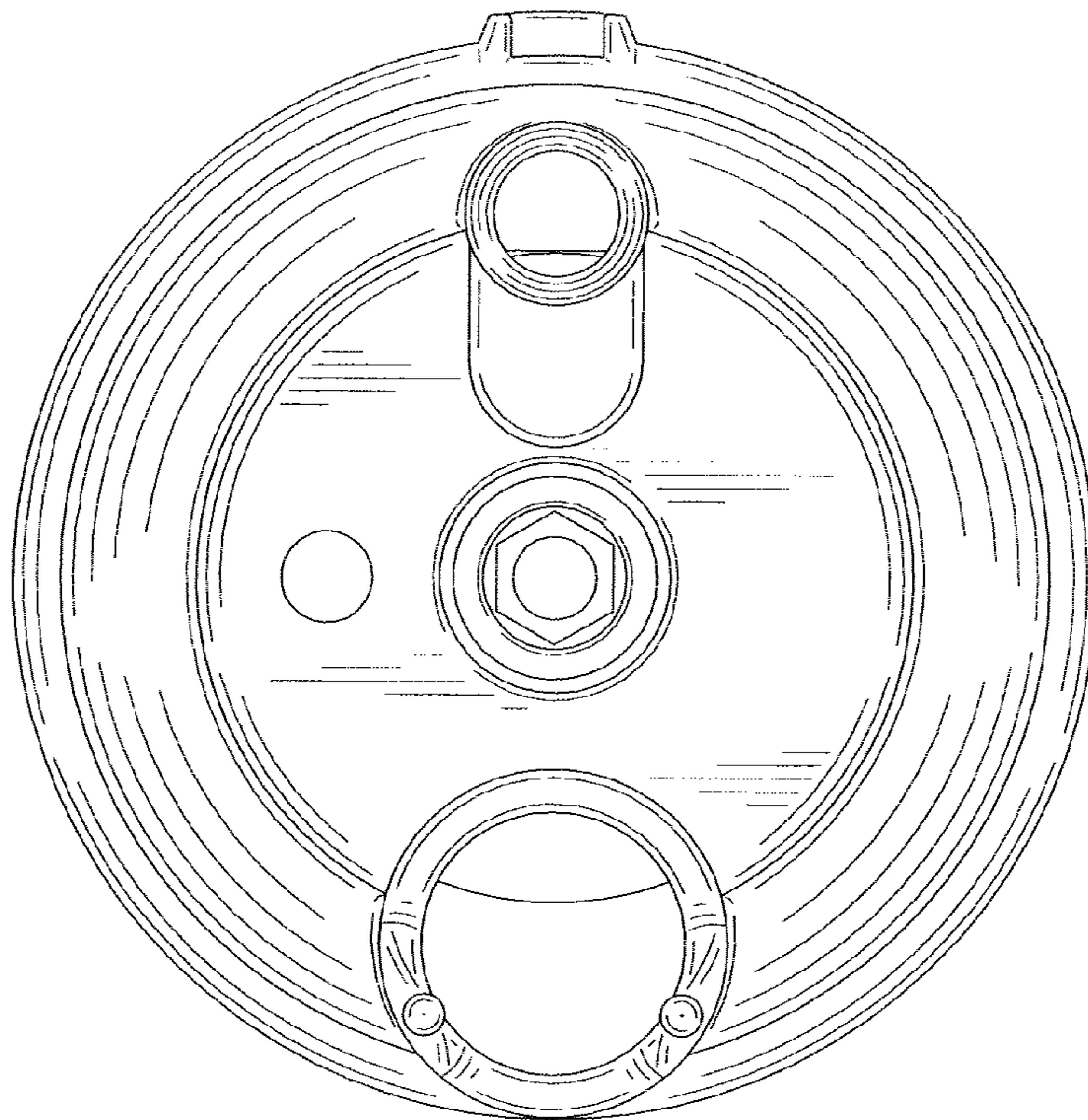

FIG. 10

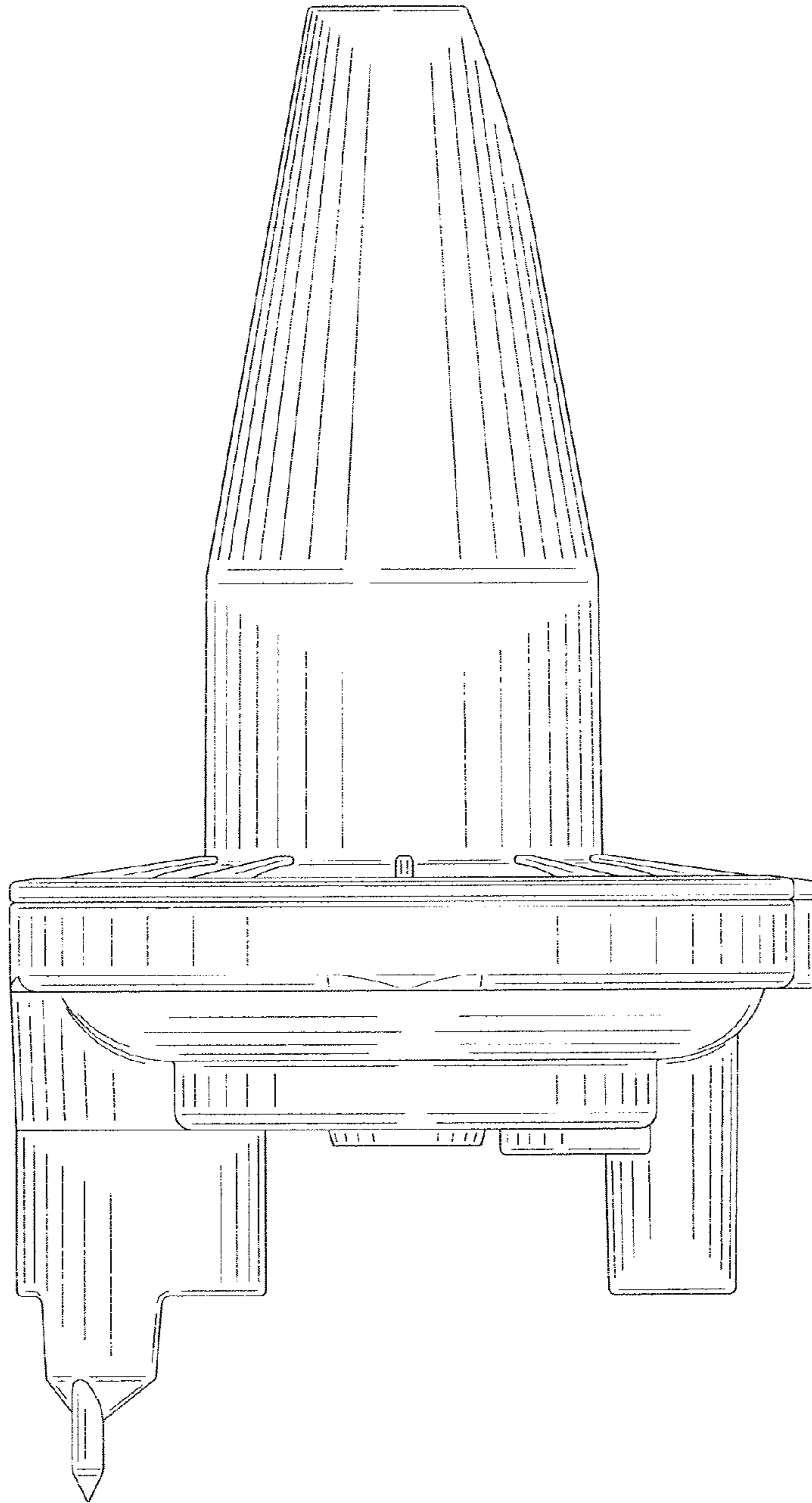

FIG. 11

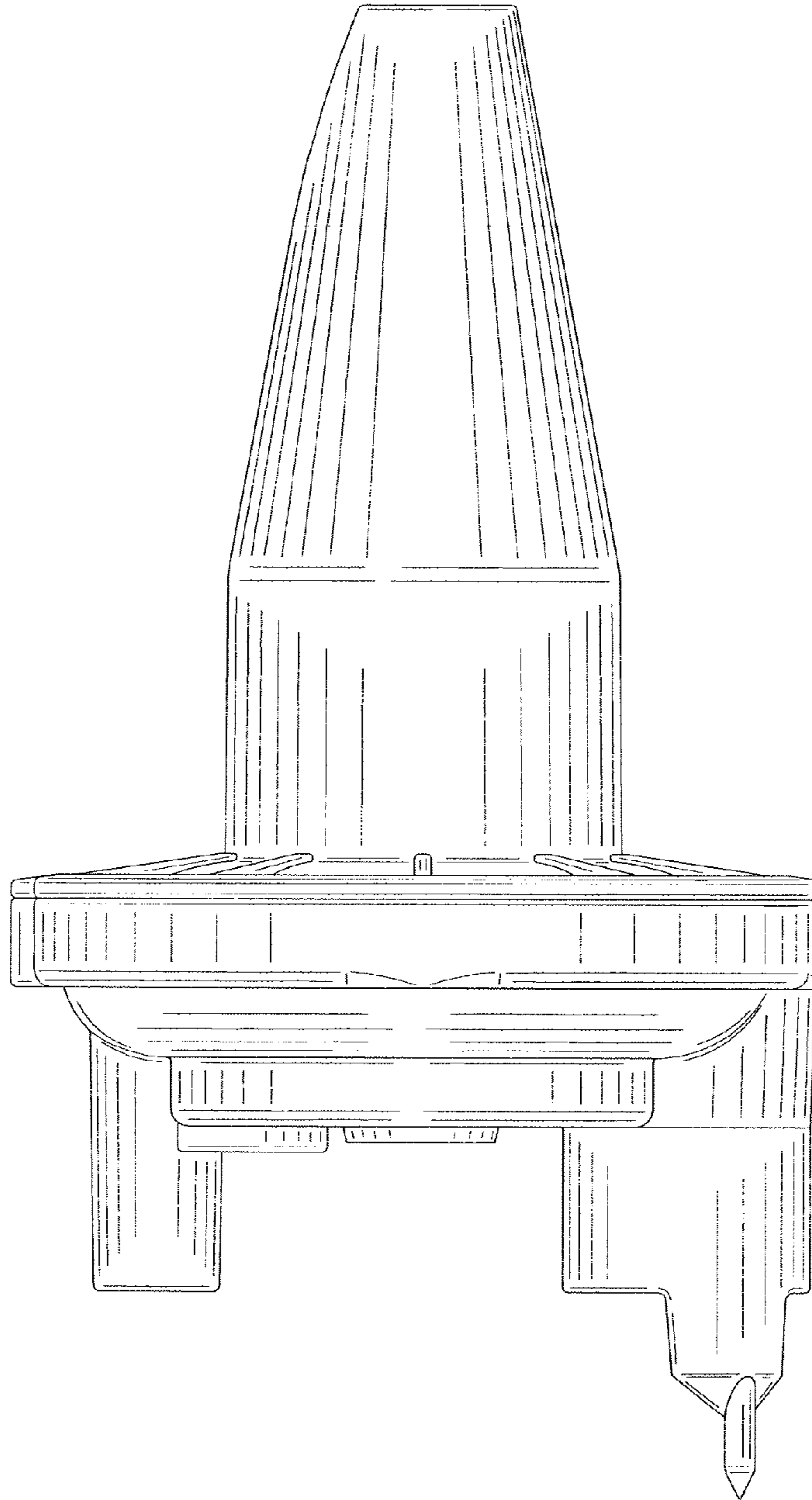

FIG. 12

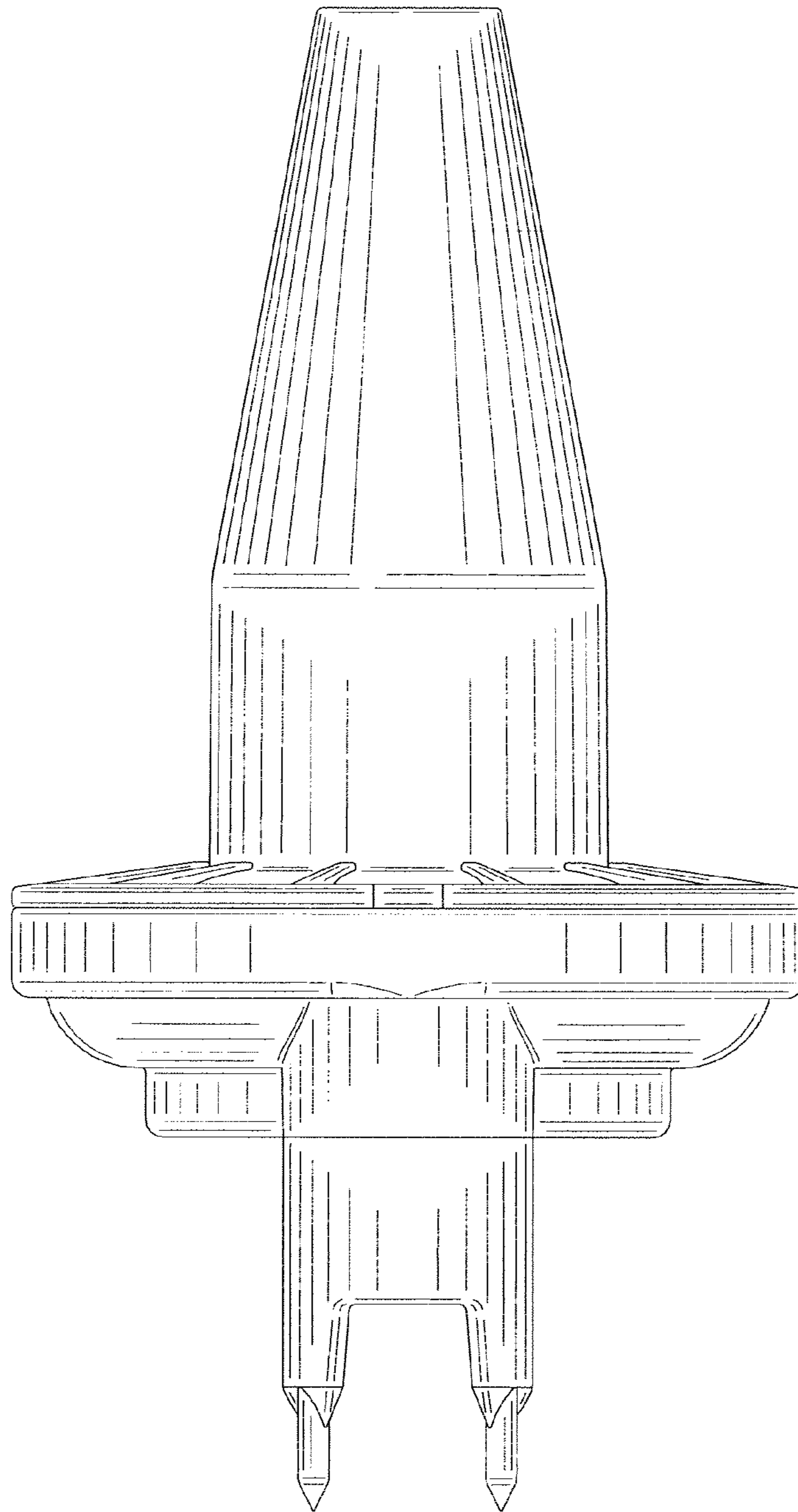

FIG. 13

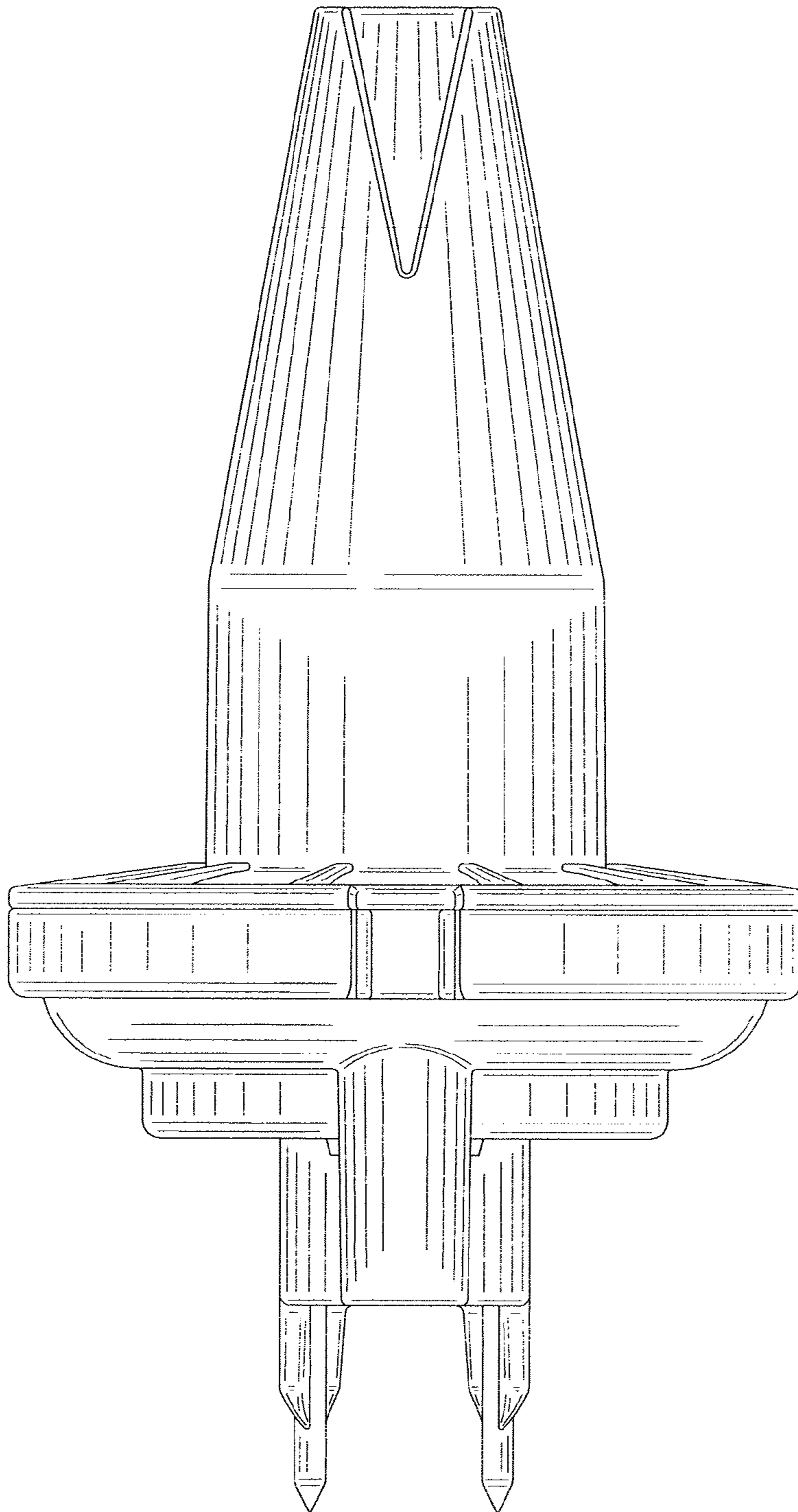
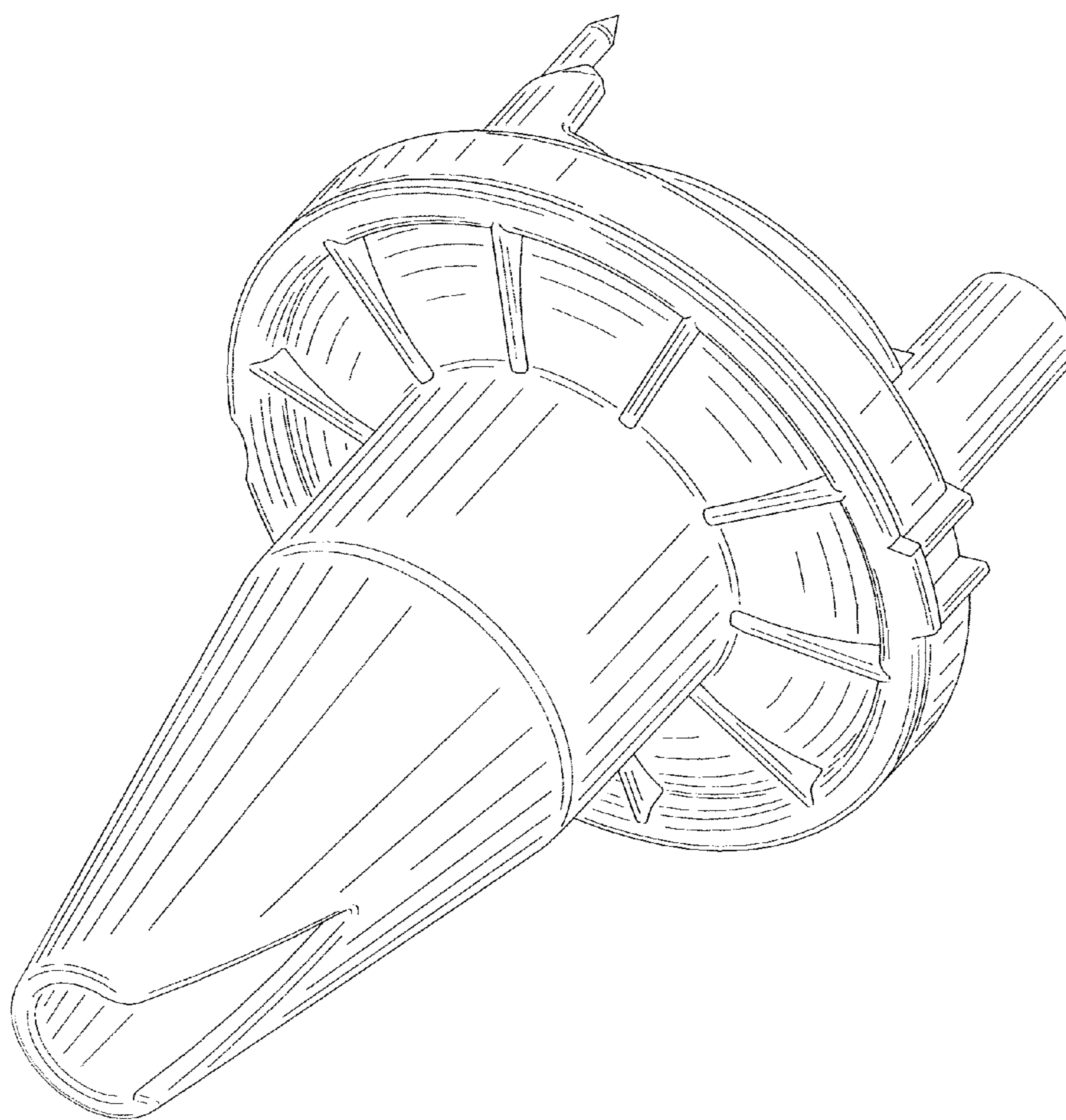

FIG. 14



UNITED STATES PATENT AND TRADEMARK OFFICE  
**CERTIFICATE OF CORRECTION**

PATENT NO. : D693,394 S  
APPLICATION NO. : 29/413778  
DATED : November 12, 2013  
INVENTOR(S) : Volker Linne et al.

Page 1 of 1

It is certified that error appears in the above-identified patent and that said Letters Patent is hereby corrected as shown below:

ON THE TITLE PAGE:

ITEM (30) add the foreign application priority data as follows:

--August 19, 2011 CH 138247--.

Signed and Sealed this  
Seventeenth Day of June, 2014



Michelle K. Lee  
*Deputy Director of the United States Patent and Trademark Office*