

US00D693330S

(12) **United States Design Patent**
Lee

(10) **Patent No.:** **US D693,330 S**
(45) **Date of Patent:** **** Nov. 12, 2013**

(54) **SPEAKER**
(75) Inventor: **Gwon-Gak Lee**, Seoul (KR)
(73) Assignee: **Samsung Electronics Co., Ltd.**,
Suwon-Si (KR)
(**) Term: **14 Years**

D529,019 S 9/2006 Lim
D530,411 S * 10/2006 Shapiro D23/314
D532,791 S 11/2006 Kim
D537,072 S 2/2007 Kim et al.
D537,073 S * 2/2007 Peersman D14/216
D540,780 S 4/2007 Kim
D545,300 S 6/2007 Hong et al.
D548,222 S 8/2007 Kim
D551,655 S 9/2007 Kim

(Continued)

(21) Appl. No.: **29/430,828**

(22) Filed: **Aug. 30, 2012**

(30) **Foreign Application Priority Data**

Apr. 13, 2012 (KR) 30-2012-0017481

(51) **LOC (9) Cl.** **14-03**

(52) **U.S. Cl.**
USPC **D14/216**; D14/215

(58) **Field of Classification Search**
USPC D14/167, 168, 170–172, 188, 194–196,
D14/204, 207, 209.1, 210–216, 221, 222;
181/143, 144, 147, 148, 150, 153, 157,
181/198, 199; 381/300–303, 306, 332, 333,
381/336, 345, 361–364, 386–388;
D13/107, 108; 455/344–351; 369/6–12
See application file for complete search history.

(56) **References Cited**

U.S. PATENT DOCUMENTS

D230,997 S * 3/1974 Shannon D14/211
D284,084 S 6/1986 Ferrara, Jr.
D306,583 S 3/1990 Krolopp et al.
D333,574 S 3/1993 Ackeret
D337,569 S 7/1993 Kando
D343,231 S * 1/1994 Lim D23/336
D471,893 S 3/2003 Jung
D484,490 S * 12/2003 Lewis D14/216
D500,991 S 1/2005 Niitsu
D504,889 S 5/2005 Andre et al.
D520,975 S 5/2006 Kim et al.

FOREIGN PATENT DOCUMENTS

KR 3004583830000 8/2007
KR 3004602570000 8/2007

(Continued)

OTHER PUBLICATIONS

U.S. Appl. No. 29/393,984, Applicant: Lee, et al., filed Jun. 10, 2011
entitled Speaker.

(Continued)

Primary Examiner — Keli L Hill
(74) *Attorney, Agent, or Firm* — Wood, Herron & Evans,
LLP

(57) **CLAIM**
The ornamental design for a speaker, as shown and described.

DESCRIPTION

FIG. 1 is a top front perspective view of a speaker showing my
new design;
FIG. 2 is a front elevational view thereof;
FIG. 3 is a rear elevational view thereof;
FIG. 4 is a left side elevational view thereof;
FIG. 5 is a right side elevational view thereof;
FIG. 6 is a top plan view thereof; and,
FIG. 7 is a bottom plan view thereof.

1 Claim, 4 Drawing Sheets

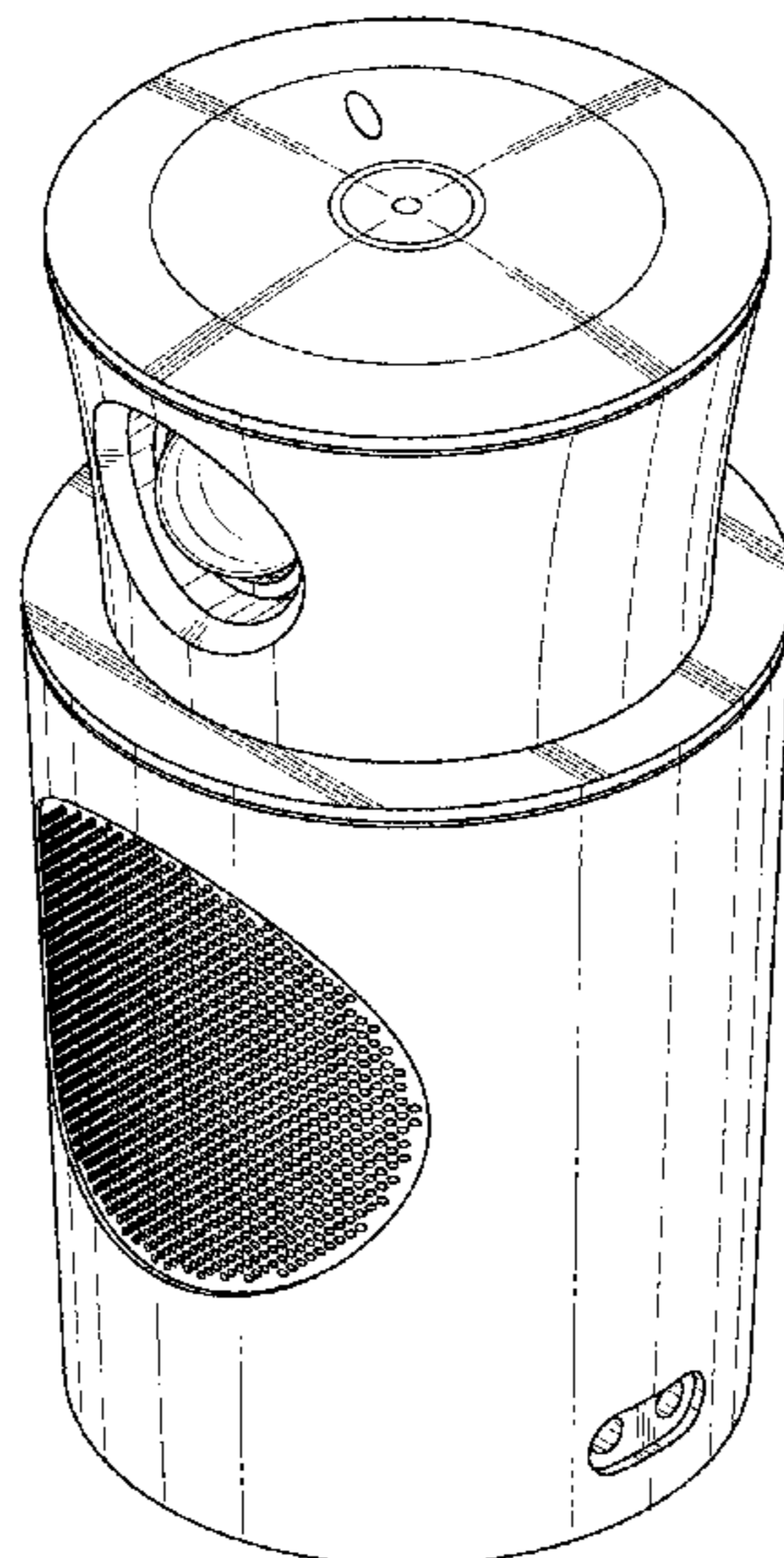

(56)

References Cited

U.S. PATENT DOCUMENTS

D551,665 S 9/2007 Tom et al.
 D560,209 S 1/2008 Kim et al.
 D560,211 S 1/2008 Kim et al.
 D560,686 S 1/2008 Kim
 D561,141 S 2/2008 Cho et al.
 D561,142 S 2/2008 Oh
 D561,161 S 2/2008 Cho
 D563,391 S * 3/2008 Skurdal D14/216
 D563,804 S 3/2008 Kimura et al.
 D567,203 S 4/2008 Park
 D570,333 S 6/2008 Cho
 D570,828 S 6/2008 Cho
 D571,785 S 6/2008 Kim
 D571,786 S 6/2008 Cho
 D573,584 S 7/2008 Kim
 D579,003 S 10/2008 Kim et al.
 D579,915 S 11/2008 Yeo
 D579,930 S 11/2008 Maskatia
 D583,801 S 12/2008 Son et al.
 D584,286 S 1/2009 Kim
 D584,288 S 1/2009 Kim
 D584,289 S * 1/2009 Lee D14/216
 D584,290 S * 1/2009 Lee D14/216
 D584,738 S 1/2009 Kim et al.
 D586,781 S 2/2009 Kim
 D586,782 S 2/2009 Kim
 D586,785 S 2/2009 Kim
 D587,237 S 2/2009 Son et al.
 D588,103 S 3/2009 Lee et al.
 D588,104 S 3/2009 Lee et al.
 D588,576 S 3/2009 Son et al.
 D590,374 S 4/2009 Madonna et al.
 D591,269 S 4/2009 Kim et al.
 D592,179 S 5/2009 Ichinose et al.
 D592,214 S 5/2009 Bradford
 D593,068 S 5/2009 Kim et al.
 D593,069 S 5/2009 Son et al.
 D598,899 S 8/2009 Tkachuk
 D602,014 S 10/2009 Andre et al.
 D602,487 S 10/2009 Maskatia
 D605,626 S 12/2009 Park
 D610,582 S 2/2010 Sugitani et al.
 D611,364 S 3/2010 Lenz et al.
 D613,310 S 4/2010 Kim
 D613,311 S 4/2010 Kim
 D613,510 S 4/2010 Tzeng et al.
 D613,951 S 4/2010 Tang et al.
 D615,530 S * 5/2010 Dobson D14/216
 D615,963 S 5/2010 Cho et al.
 D617,314 S * 6/2010 Zha D14/216
 D617,793 S 6/2010 Chiang et al.

D622,270 S 8/2010 Andre et al.
 D624,047 S 9/2010 Kim
 D624,048 S 9/2010 Kim
 D627,667 S 11/2010 Lenz et al.
 D628,556 S 12/2010 Lee et al.
 D628,913 S 12/2010 Cheng
 D629,388 S 12/2010 Son et al.
 D629,799 S 12/2010 Andre et al.
 D631,868 S 2/2011 Chung
 D633,076 S 2/2011 Kim et al.
 D634,302 S 3/2011 Chung et al.
 D640,255 S 6/2011 Lee et al.
 D657,774 S 4/2012 Chung et al.
 D660,285 S 5/2012 Lee et al.
 D660,286 S 5/2012 Lee et al.
 D671,525 S 11/2012 Chung
 2009/0231292 A1 9/2009 Hsieh et al.

FOREIGN PATENT DOCUMENTS

KR 3004608520000 8/2007
 KR 3004659690000 10/2007
 KR 3005005060000 7/2008
 KR 3005992810000 5/2011
 KR 3006052260000 7/2011
 KR 3006060320000 7/2011
 KR 3006063520000 7/2011
 KR 3006067150000 7/2011
 KR 3006067180000 7/2011
 KR 3006067290000 7/2011
 KR 3006067430000 7/2011
 KR 3006067570000 7/2011
 KR 3006076710000 8/2011

OTHER PUBLICATIONS

U.S. Appl. No. 29/393,985, Applicant: Lee, et al., filed Jun. 10, 2011 entitled Speaker.
 U.S. Appl. No. 29/430,822, Applicant: Lee, Gwon-Gak, filed Sep. 30, 2012 entitled Speaker.
 U.S. Appl. No. 29/419,031, Applicant: Shim et al., filed Apr. 24, 2012 entitled Speaker.
 U.S. Appl. No. 29/419,036, Applicant: Lee et al., filed Apr. 24, 2012 entitled Speaker.
 U.S. Appl. No. 29/428,264, Applicant: Son et al., filed Jul. 27, 2012 entitled Speaker.
 U.S. Appl. No. 29/430,812, Applicant: Lee, Gil-Jae., filed Aug. 30, 2012 entitled Speaker.
 U.S. Appl. No. 29/431,755, Applicant: Lee, Gil-Jae, filed Sep. 11, 2012 entitled Speaker.
 U.S. Appl. No. 291431,753, Applicant: Lee et al., filed Sep. 11, 2012 entitled Speaker.

* cited by examiner

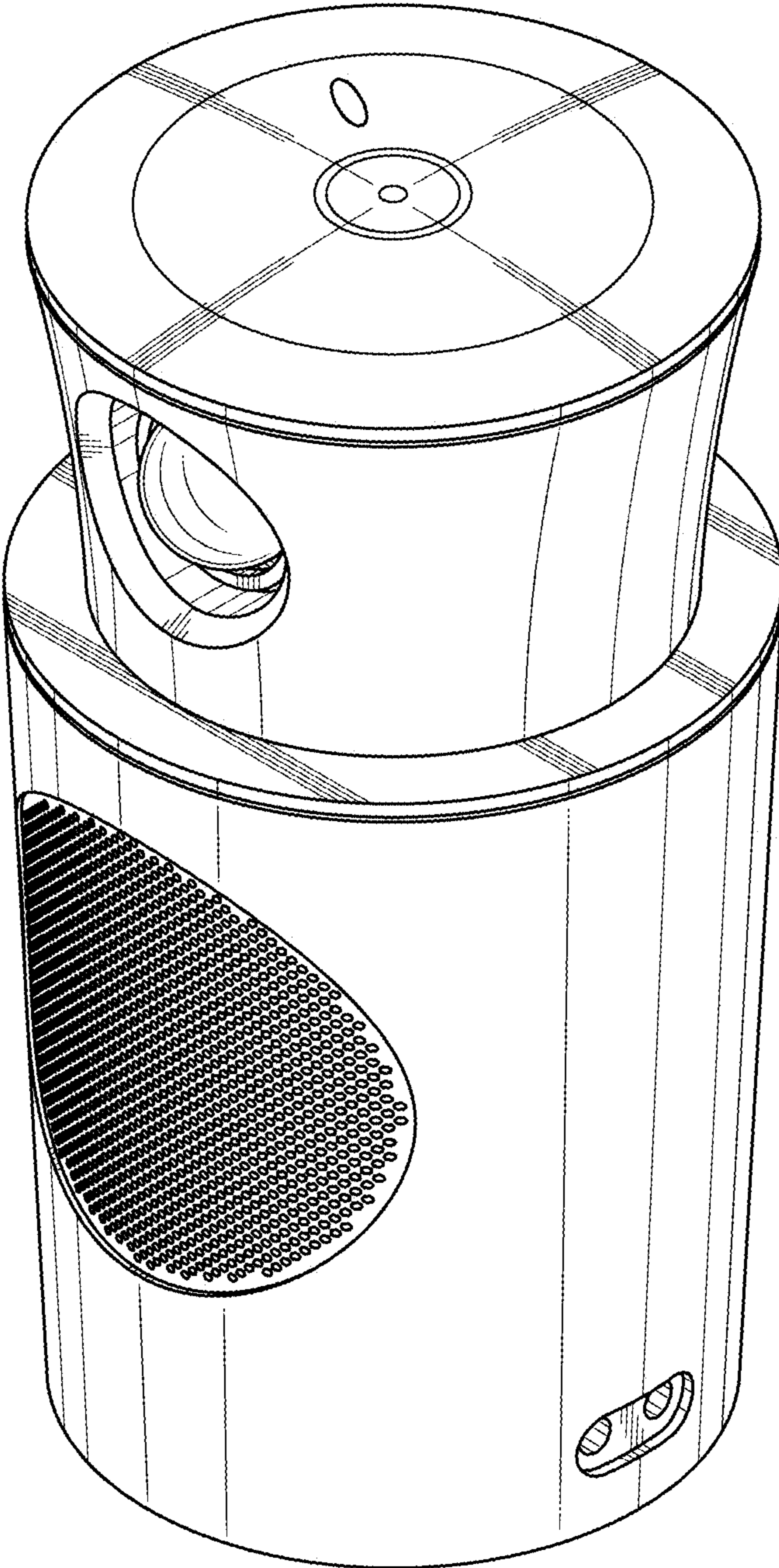

FIG.1

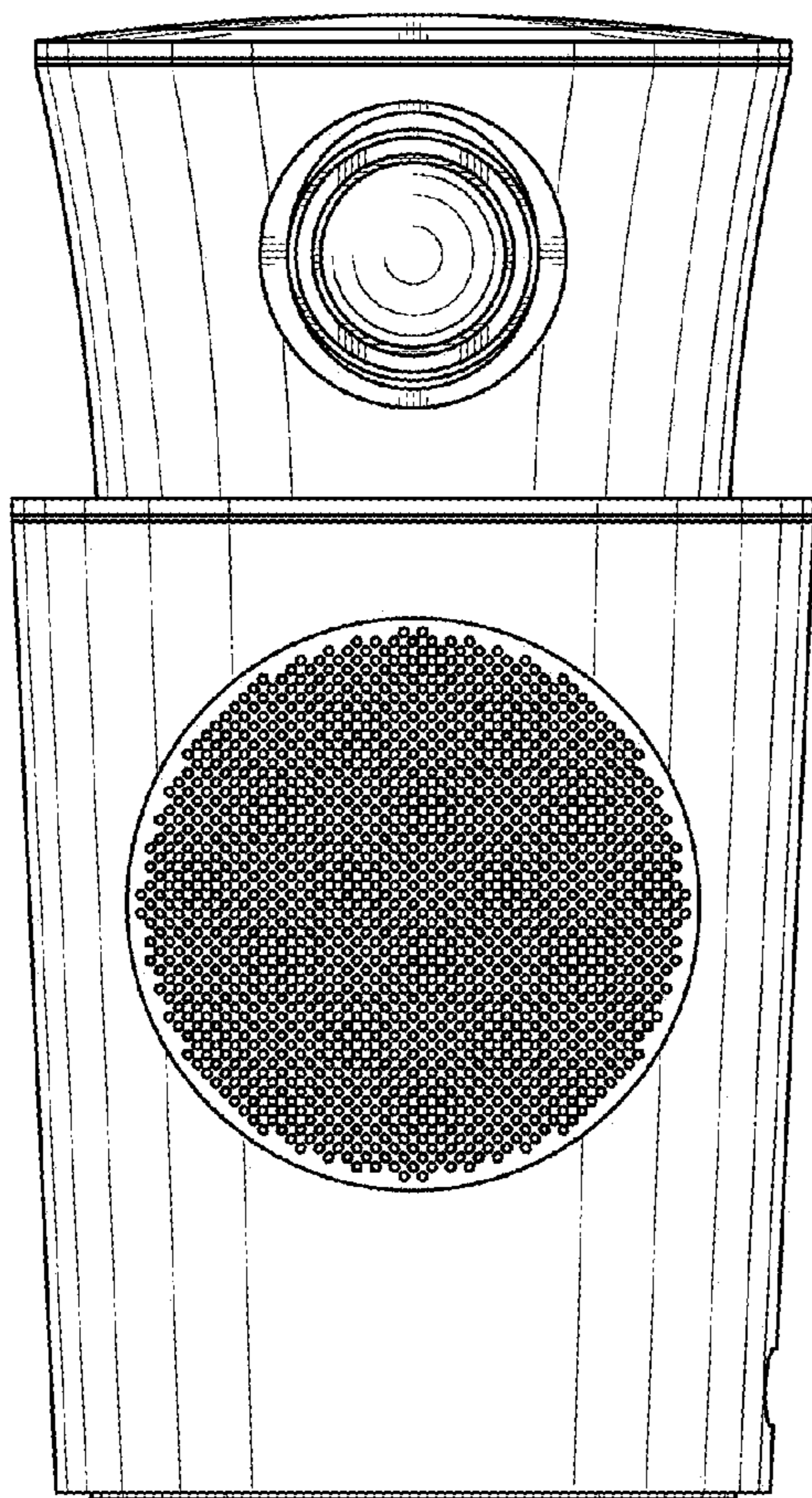

FIG. 2

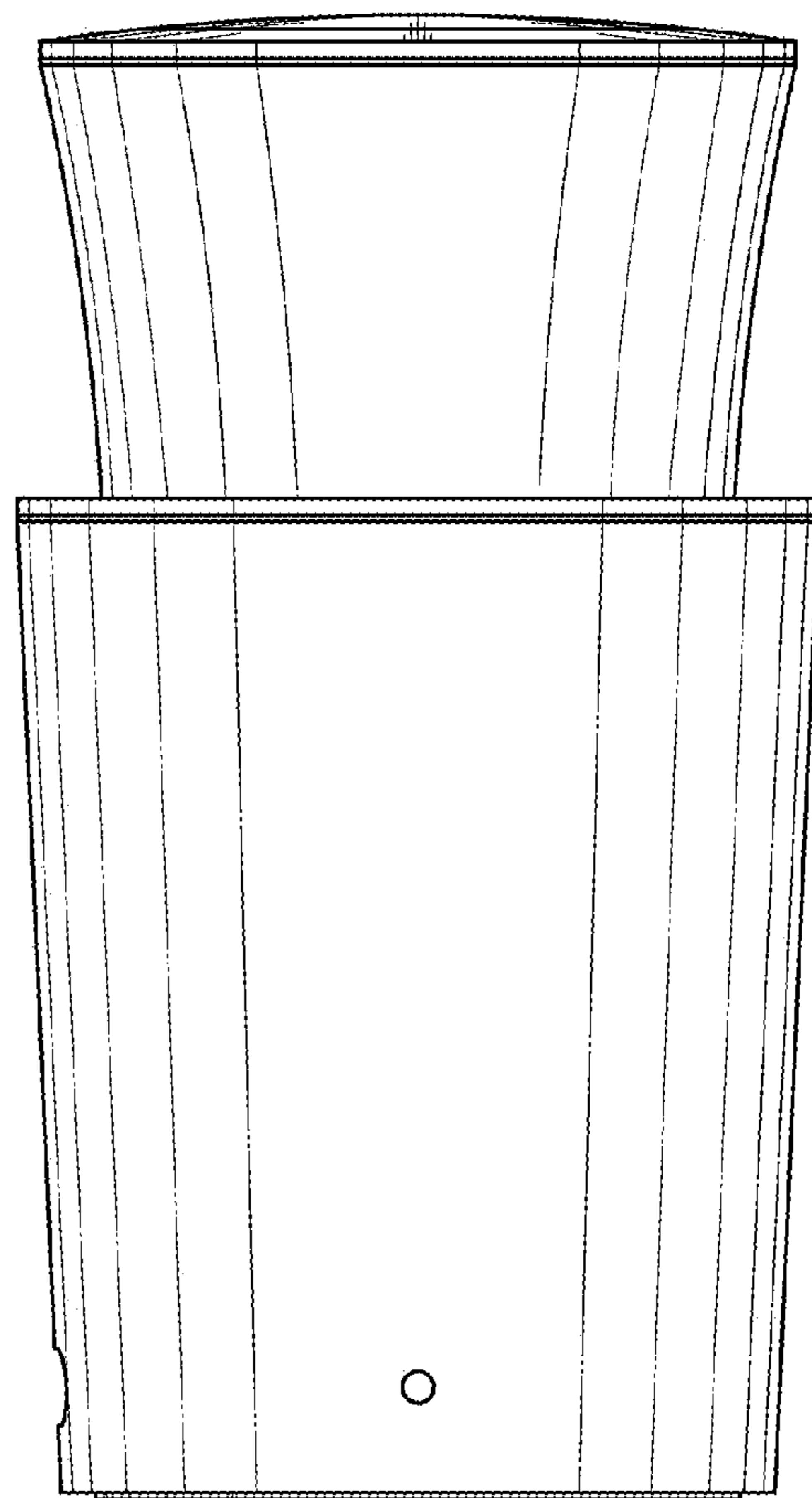

FIG. 3

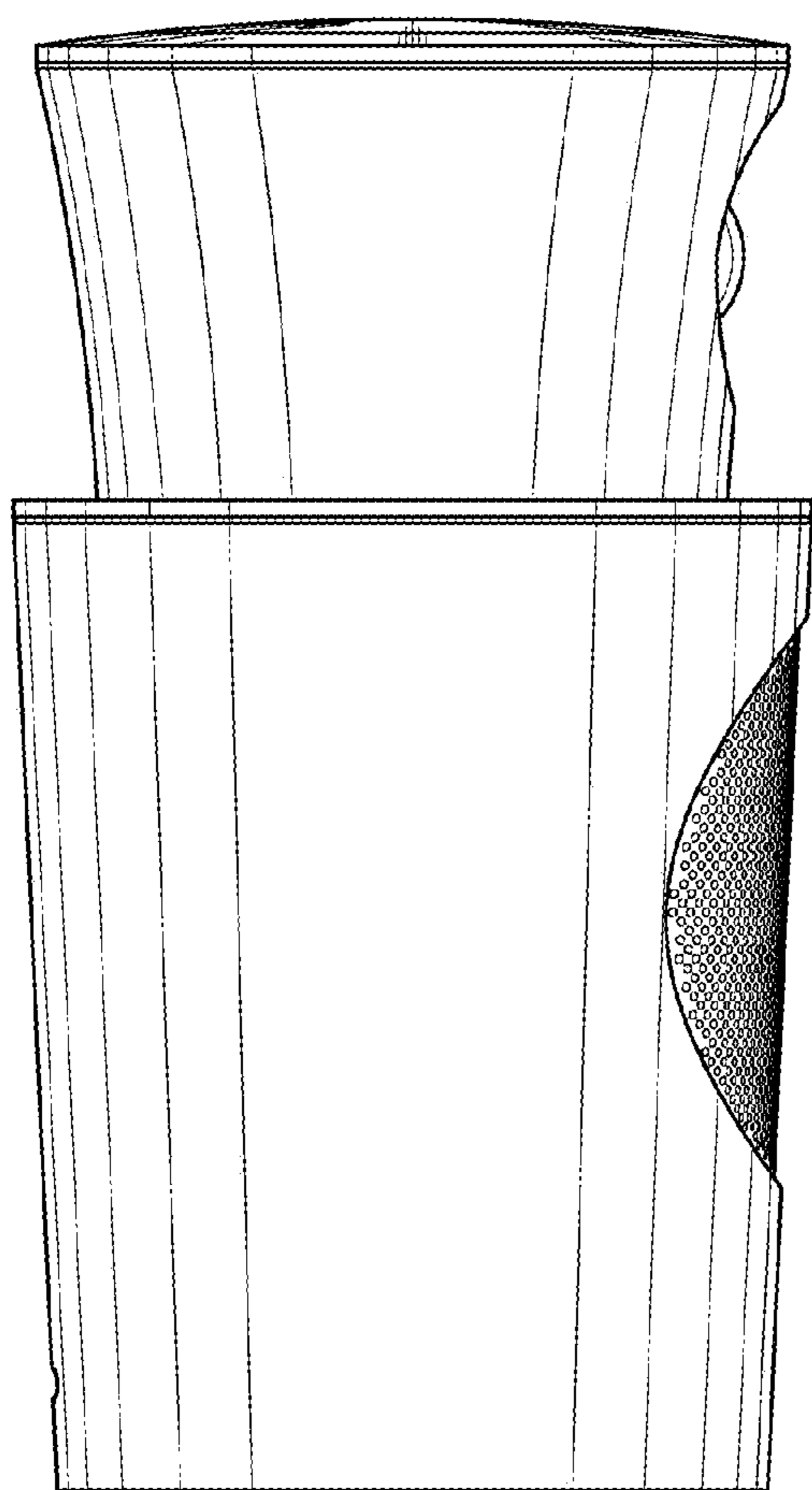

FIG. 4

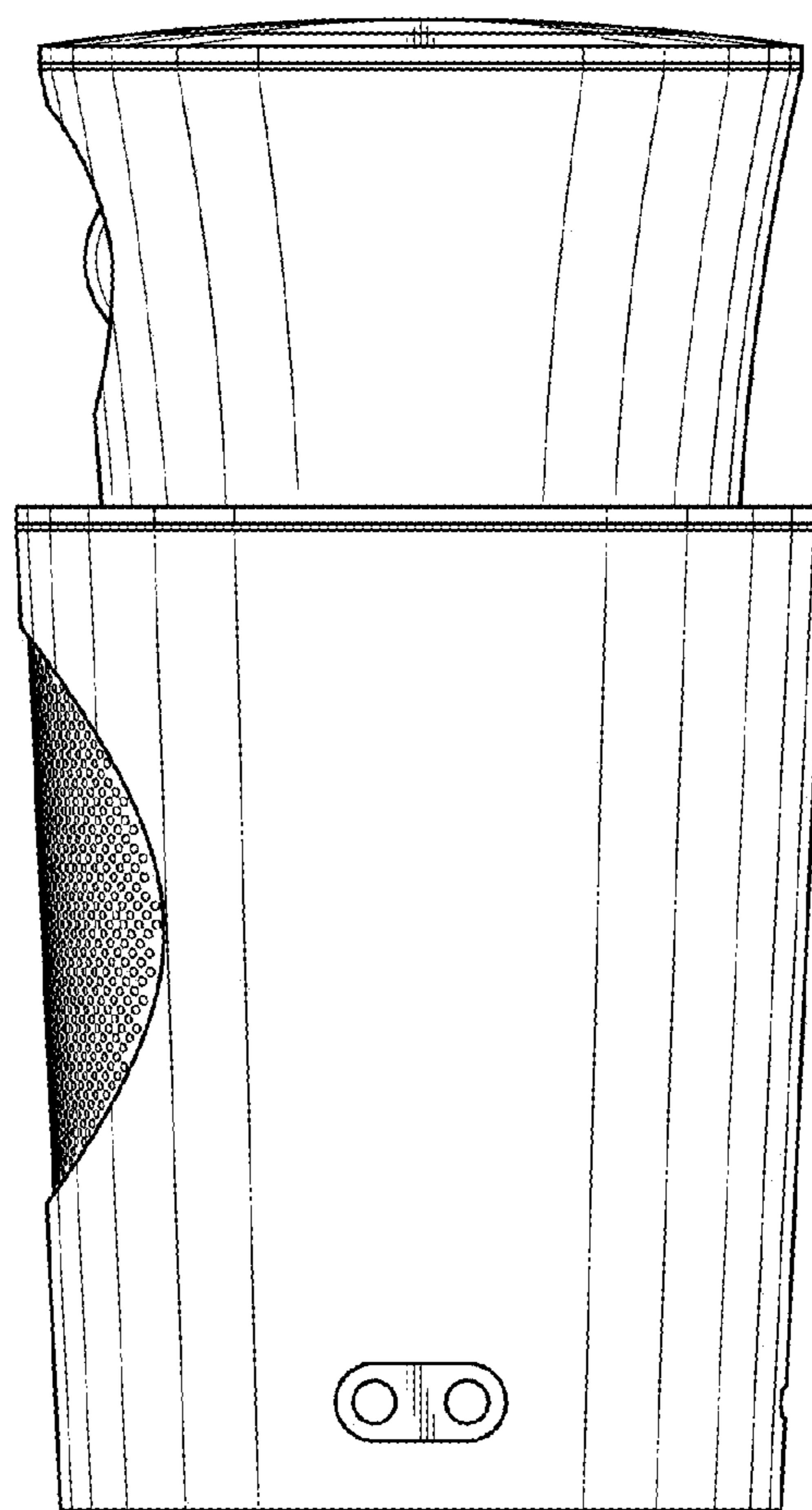

FIG. 5

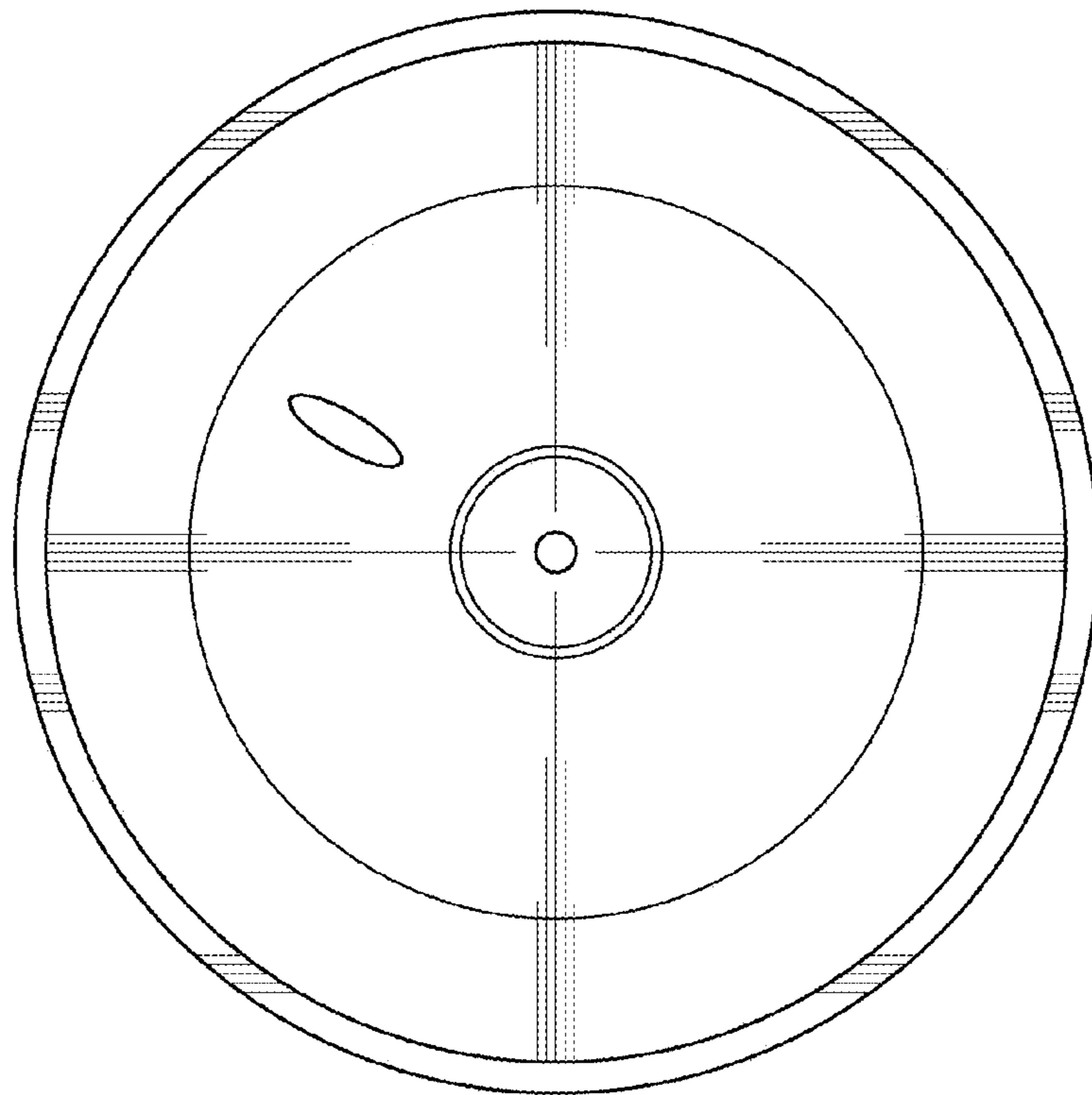

FIG. 6

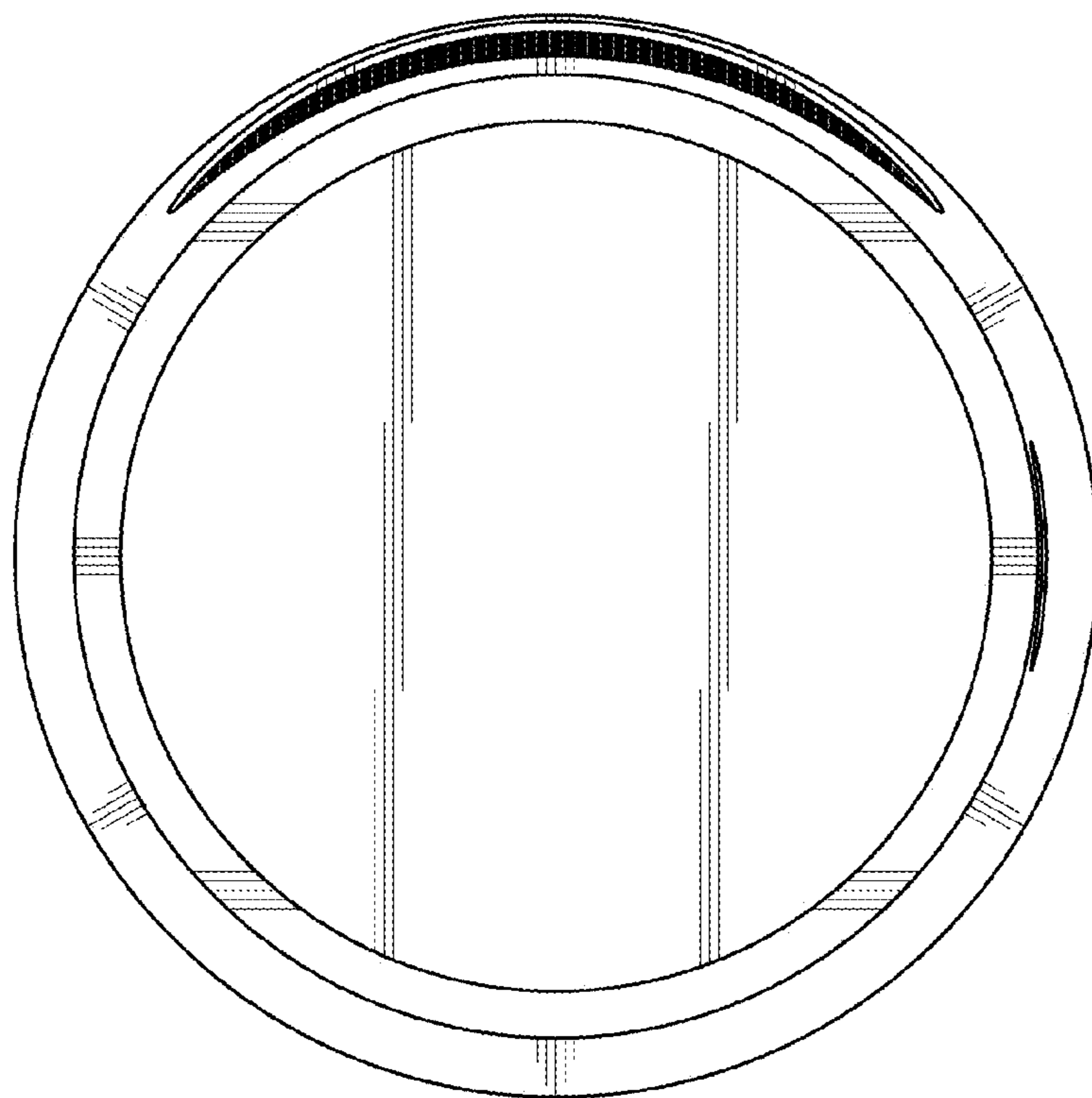

FIG. 7