



US00D693322S

(12) **United States Design Patent**  
**Jeong**

(10) **Patent No.:** **US D693,322 S**

(45) **Date of Patent:** **\*\* \*Nov. 12, 2013**

(54) **MOBILE COMMUNICATION TERMINAL**

(75) Inventor: **Jong-Il Jeong**, Seoul (KR)

(73) Assignee: **Samsung Electronics Co., Ltd.**,  
Suwon-Si (KR)

(\* ) Notice: This patent is subject to a terminal disclaimer.

(\*\*) Term: **14 Years**

(21) Appl. No.: **29/417,268**

(22) Filed: **Apr. 2, 2012**

(30) **Foreign Application Priority Data**

Nov. 24, 2011 (KR) ..... 30-2011-0049614

(51) **LOC (9) Cl.** ..... **14-03**

(52) **U.S. Cl.**  
USPC ..... **D14/138 AA**

(58) **Field of Classification Search**

USPC ..... D14/138 AA, 138 R, 496, 341, 345, 346,  
D14/203.1, 203.4, 203.7, 147, 218;  
D21/517; 455/575.1, 556.2;  
379/433.01, 433.04

See application file for complete search history.

(56) **References Cited**

**U.S. PATENT DOCUMENTS**

D475,033 S *	5/2003	Lehtonen	.....	D14/138 AD
D479,213 S *	9/2003	Ansley et al.	.....	D14/138 AA
D492,274 S *	6/2004	Widiaman	.....	D14/138 AA
D496,342 S *	9/2004	Clemens et al.	.....	D14/138 AA
D511,507 S *	11/2005	Chintala et al.	.....	D14/138 AA
D514,079 S *	1/2006	Lai	.....	D14/138 AA
D515,543 S *	2/2006	Shintani	.....	D14/138 AA
D525,229 S *	7/2006	Friesen et al.	.....	D14/138 AA
D545,800 S *	7/2007	Ou et al.	.....	D14/138 AA
D549,677 S *	8/2007	Fahlgren	.....	D14/138 AA
D551,199 S *	9/2007	Cho et al.	.....	D14/138 AB

(Continued)

**OTHER PUBLICATIONS**

Samsung C3350 is an Xcover rugged candybar headed to Europe soon for € 179, posted Oct 13, 2011, Vlad Bobleanta, [online], [site visited Sep. 18, 2012]. Available from Internet, <URL: <http://www.unwiredview.com/2011/10/13/samsung-c3350-is-an-xcover-rugged-candybar-headed-to-europe-soon-for-e179/>>.\*

(Continued)

*Primary Examiner* — Jeffrey D Asch

(74) *Attorney, Agent, or Firm* — Staas & Halsey LLP

(57) **CLAIM**

The ornamental design for a mobile communication terminal, as shown and described.

**DESCRIPTION**

FIG. 1 is a front perspective view of a mobile communication terminal;

FIG. 2 is a front view of the mobile communication terminal of FIG. 1;

FIG. 3 is a rear view of the mobile communication terminal of FIG. 1;

FIG. 4 is a left-side view of the mobile communication terminal of FIG. 1;

FIG. 5 is a right-side view of the mobile communication terminal of FIG. 1;

FIG. 6 is a top plan view of the mobile communication terminal of FIG. 1; and,

FIG. 7 is a bottom plan view of the mobile communication terminal of FIG. 1.

The broken lines shown in the figures that are immediately adjacent to the shaded areas and define unshaded regions represent the bounds in the claim. All other broken lines, including any features or group of features shown in broken lines that are superimposed on shaded surfaces, are directed to environment and are for illustrative purposes only. The broken lines form no part of the claimed design.

**1 Claim, 7 Drawing Sheets**

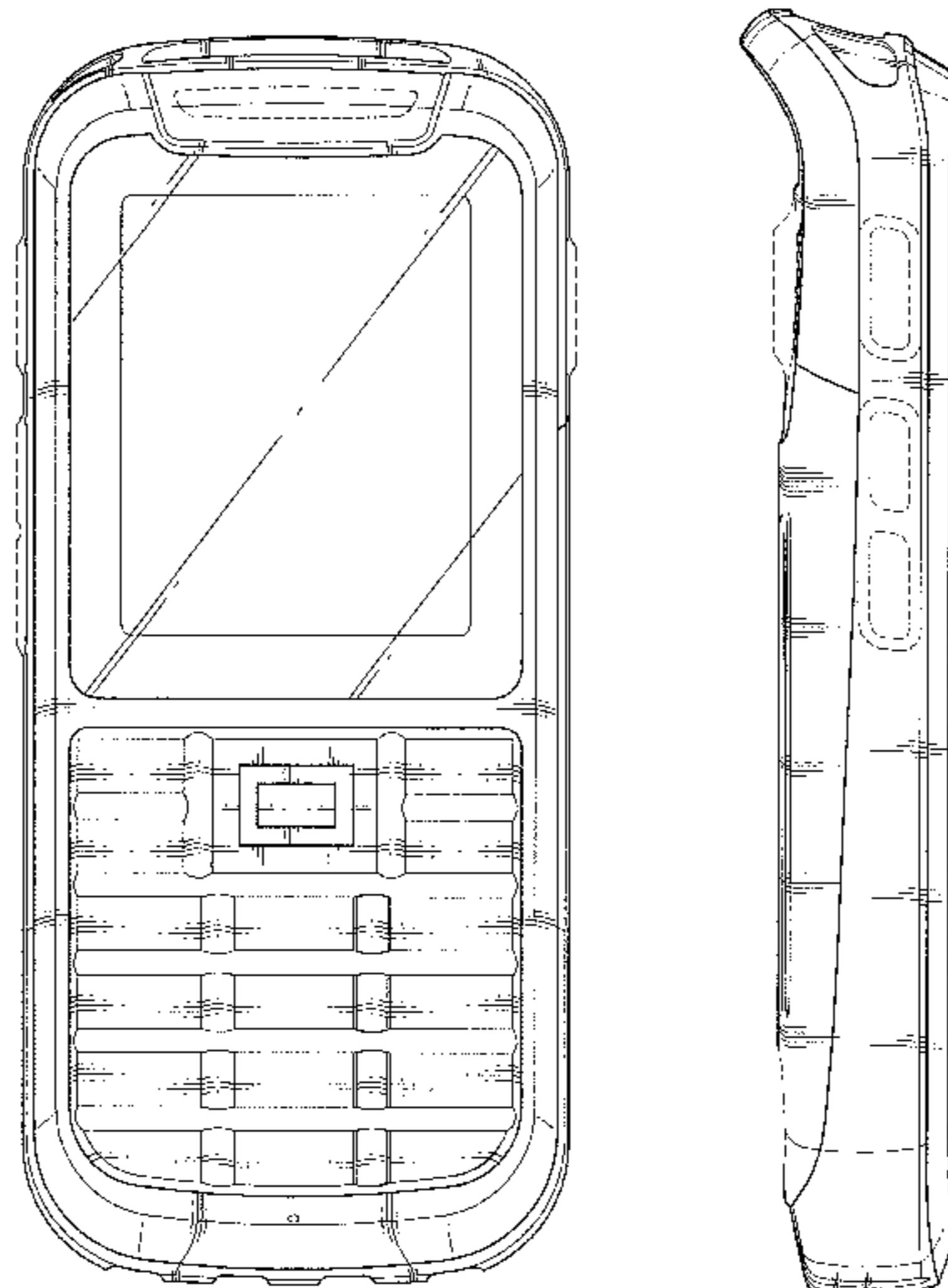

(56)

References Cited

U.S. PATENT DOCUMENTS

D560,630	S *	1/2008	Mitchell et al. ....	D14/138 AA
D563,374	S *	3/2008	Jung et al. ....	D14/138 AA
D565,000	S *	3/2008	Pitt .....	D14/138 AA
D568,849	S *	5/2008	Nuovo .....	D14/138 AA
D572,700	S *	7/2008	Kwon et al. ....	D14/138 AA
D576,582	S *	9/2008	Gartrell .....	D14/138 AA
D601,533	S *	10/2009	Youn et al. ....	D14/138 AA
D610,110	S *	2/2010	Lee et al. ....	D14/138 AA
D610,121	S *	2/2010	Lee et al. ....	D14/138 AA
D611,442	S *	3/2010	Kim et al. ....	D14/138 AA
D615,060	S *	5/2010	Kim et al. ....	D14/138 AA
D617,298	S *	6/2010	Kim et al. ....	D14/138 AA
D618,196	S *	6/2010	Bang et al. ....	D14/138 AA
D618,202	S *	6/2010	Chaumont et al. ....	D14/138 AA
D618,648	S *	6/2010	Bang et al. ....	D14/138 AA
D622,686	S *	8/2010	Muspratt-Williams et al. ....	D14/138 AA
D641,334	S *	7/2011	Hong et al. ....	D14/138 AA
D643,006	S *	8/2011	Han et al. ....	D14/138 G
D646,254	S *	10/2011	Kim et al. ....	D14/138 G
D654,049	S *	2/2012	Chung .....	D14/138 G
8,224,404	B2 *	7/2012	Yang et al. ....	455/575.1
2004/0180703	A1 *	9/2004	Kim et al. ....	455/575.1

OTHER PUBLICATIONS

Samsung C3350 telephone, announced Oct. 2011, [online], [site visited Sep. 10, 2012]. Available from Internet, <URL: [http://www.gsmarena.com/samsung\\_c3350-4271.php](http://www.gsmarena.com/samsung_c3350-4271.php)>.\*

Samsung E1130B telephone, announced Oct. 2009, [online], [site visited Sep. 10, 2012]. Available from Internet, <URL: [http://www.gsmarena.com/samsung\\_e1130b-2977.php](http://www.gsmarena.com/samsung_e1130b-2977.php)>.\*

Samsung E2370 Xcover telephone, announced Feb. 2010, [online], [site visited Sep. 10, 2012]. Available from Internet, <URL: [http://www.gsmarena.com/samsung\\_e2370\\_xcover-3152.php](http://www.gsmarena.com/samsung_e2370_xcover-3152.php)>.\*

Samsung B2100 Xplorer telephone, announced Mar. 2009, [online], [site visited Sep. 10, 2012]. Available from Internet, <URL: [http://www.gsmarena.com/samsung\\_b2100\\_xplorer-2747.php](http://www.gsmarena.com/samsung_b2100_xplorer-2747.php)>.\*

Samsung B2700 telephone, announced Sep. 2008, [online], [site visited Sep. 10, 2012]. Available from Internet, <URL: [http://www.gsmarena.com/samsung\\_b2700-2507.php](http://www.gsmarena.com/samsung_b2700-2507.php)>.\*

Samsung Xcover 271 telephone, announced Sep. 2010, [online], [site visited Sep. 10, 2012]. Available from Internet, <URL: [http://www.gsmarena.com/samsung\\_xcover\\_271-3415.php](http://www.gsmarena.com/samsung_xcover_271-3415.php)>.\*

Verykool i123 telephone, announced Aug. 2012, [online], [site visited Sep. 10, 2012]. Available from Internet, <URL: [http://www.gsmarena.com/verykool\\_i123-4902.php](http://www.gsmarena.com/verykool_i123-4902.php)>.\*

\* cited by examiner

FIG. 1

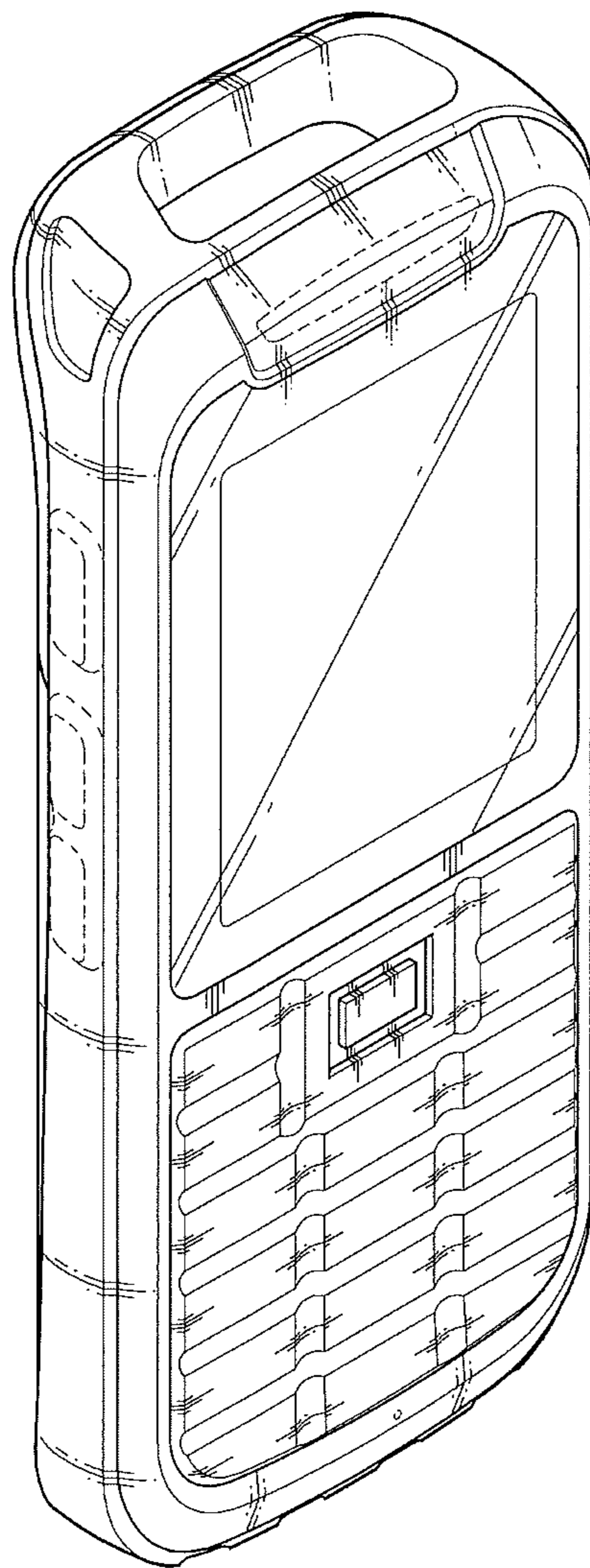

FIG. 2

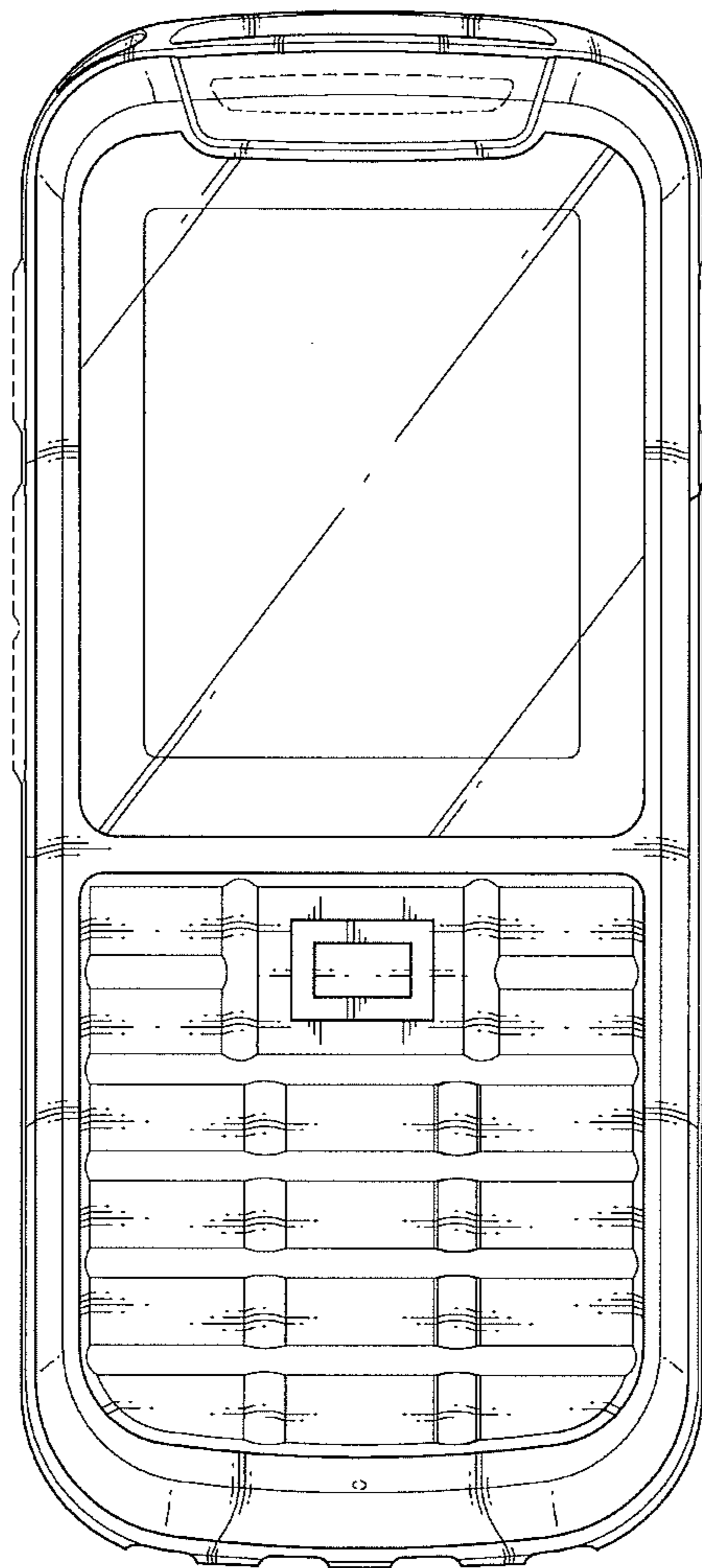

FIG. 3

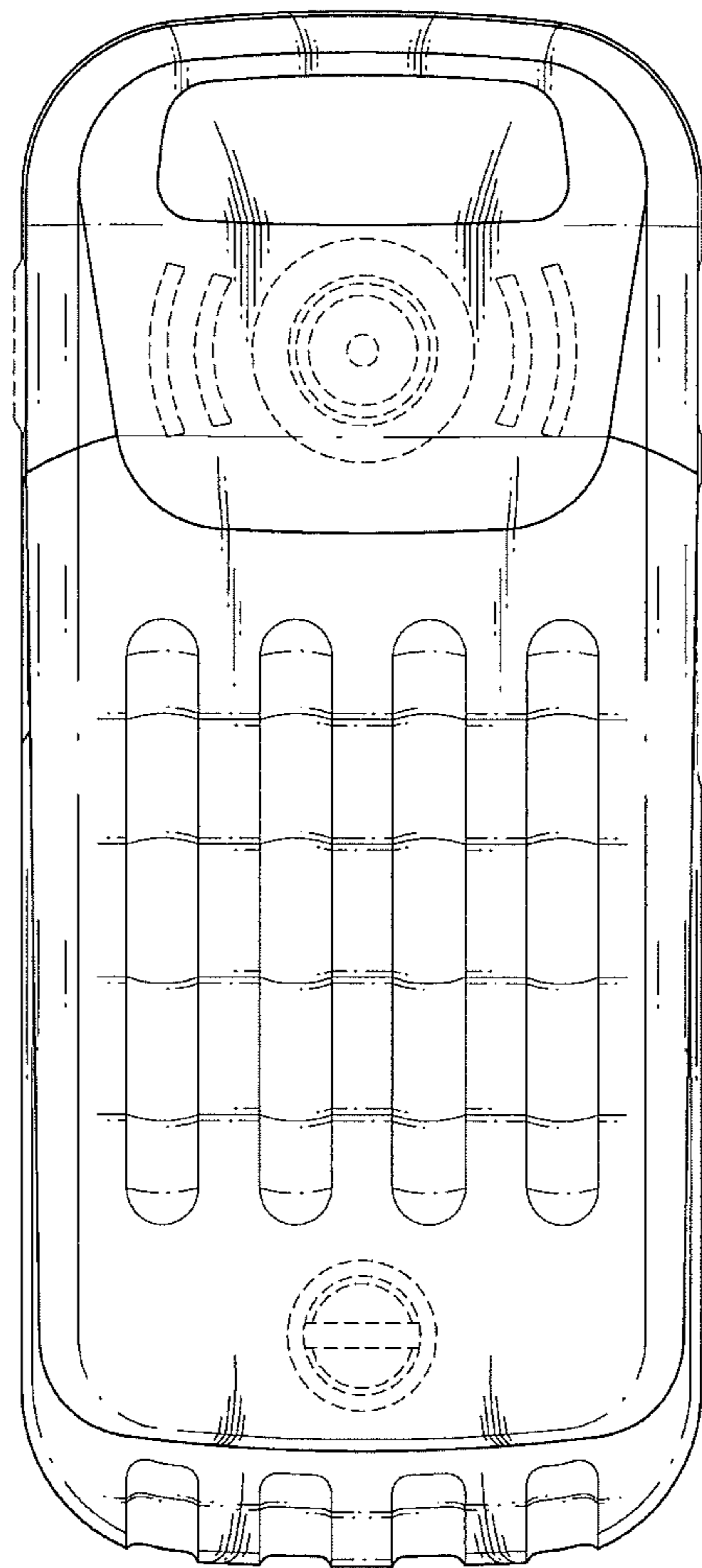

FIG. 4

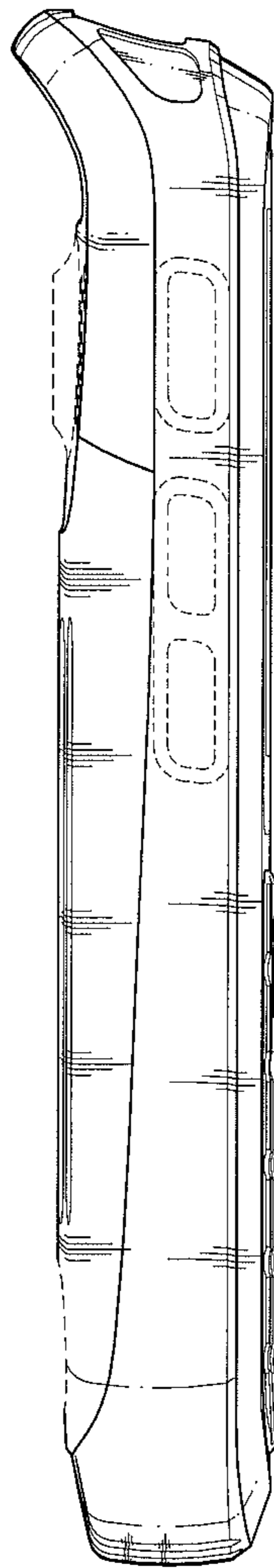

FIG. 5

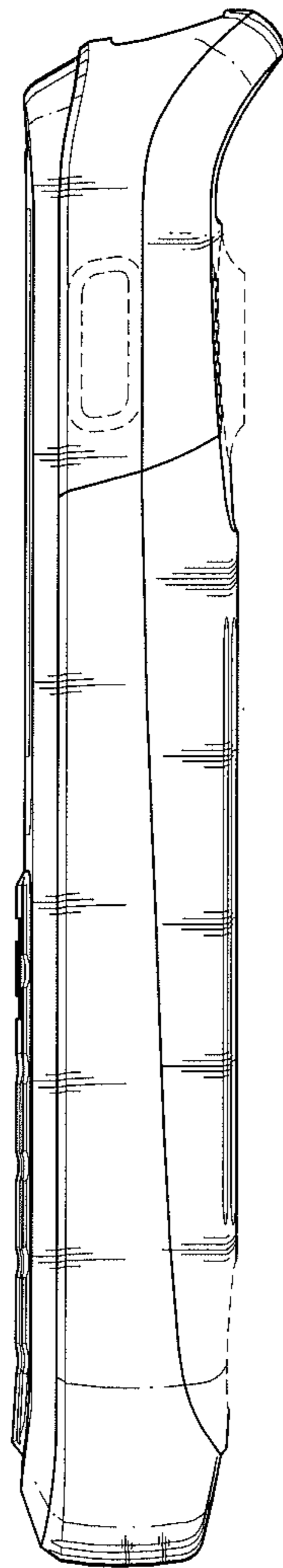

FIG. 6

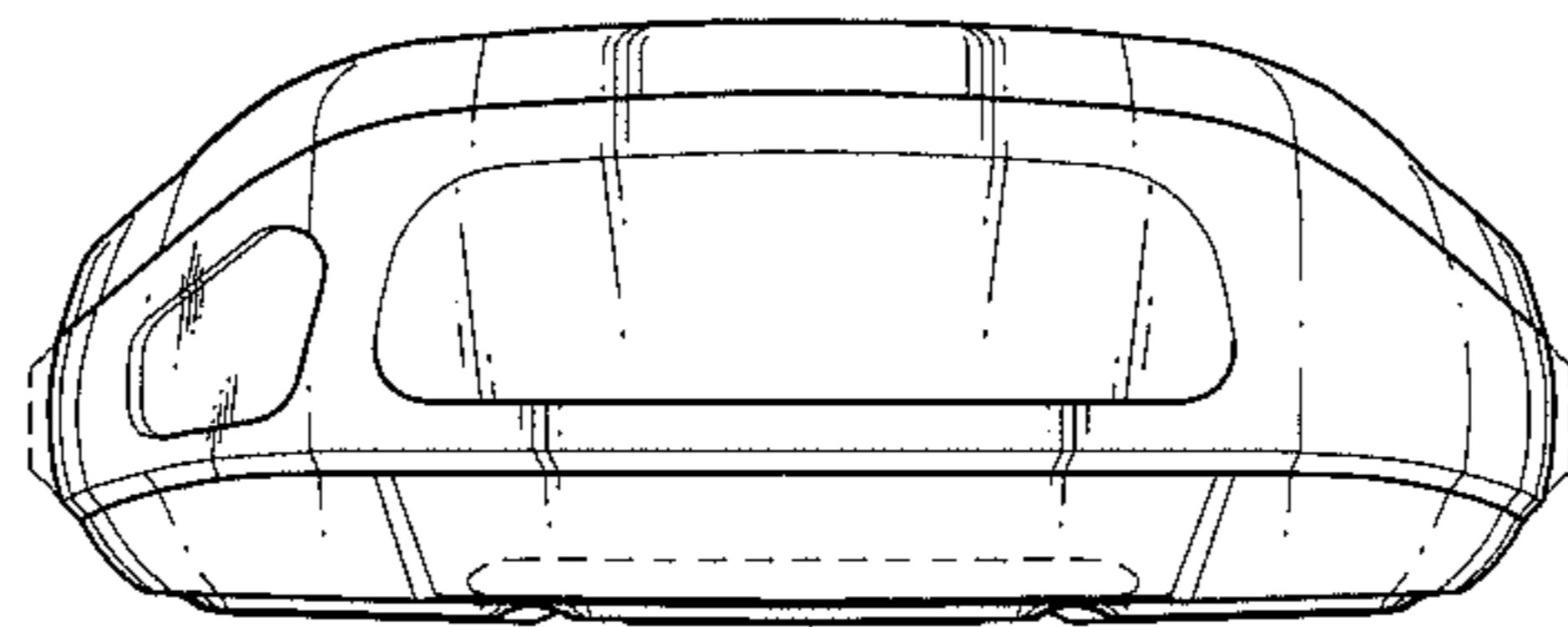



FIG. 7

