



US00D693306S

(12) **United States Design Patent**
Chuang et al.

(10) **Patent No.:** **US D693,306 S**

(45) **Date of Patent:** **** Nov. 12, 2013**

(54) **CASE OF ELECTRICAL RECEPTACLE**

(71) Applicant: **Institute for Information Industry,**
Taipei (TW)

(72) Inventors: **Chi-Cheng Chuang,** Kaohsiung (TW);
Ji-Tsong Shieh, New Taipei (TW);
Chun-Yun Ku, Taipei (TW);
Chung-Shih Sun, New Taipei (TW)

(73) Assignee: **Institute for Information Industry,**
Taipei (TW)

(**) Term: **14 Years**

(21) Appl. No.: **29/439,678**

(22) Filed: **Dec. 13, 2012**

(30) **Foreign Application Priority Data**

Oct. 31, 2012 (TW) 101306387

(51) **LOC (9) Cl.** **13-03**

(52) **U.S. Cl.**
USPC **D13/139.1**

(58) **Field of Classification Search**
USPC D13/133, 138.1, 139.1, 152, 153, 154,
D13/156, 157; D14/184, 199, 205, 228,
D14/238.1; 439/892, 894, 901; 379/431;
D20/222; D9/415, 702, 711, 713, 715
See application file for complete search history.

(56) **References Cited**

U.S. PATENT DOCUMENTS

D400,505 S * 11/1998 Yu D13/139.6
D420,602 S * 2/2000 Lamar et al. D10/40
D436,923 S * 1/2001 Stekelenburg D13/139.8

D445,403 S * 7/2001 Veino et al. D13/154
D511,140 S * 11/2005 Blake et al. D13/139.8
D581,874 S * 12/2008 Zhou D13/139.6
D636,345 S * 4/2011 Cullen et al. D13/154
D642,982 S * 8/2011 Shi D13/139.1

* cited by examiner

Primary Examiner — Robert M Spear

Assistant Examiner — Rhea Shields

(74) *Attorney, Agent, or Firm* — Skaar Ulbrich Macari, P.A.

(57) **CLAIM**

We claim the ornamental design for a case of electrical receptacle, as shown and described.

DESCRIPTION

FIG. 1 is a perspective view of the first embodiment showing the claimed design;

FIG. 2 is another perspective view of FIG. 1;

FIG. 3 is a front elevational view of FIG. 1;

FIG. 4 is a rear elevational view of FIG. 1;

FIG. 5 is a left side elevational view of FIG. 1;

FIG. 6 is a right side elevational view of FIG. 1;

FIG. 7 is a top plan view of FIG. 1;

FIG. 8 is a bottom plan view of FIG. 1;

FIG. 9 is a perspective view of the second embodiment showing the claimed design;

FIG. 10 is another perspective view of FIG. 9;

FIG. 11 is a front elevational view of FIG. 9;

FIG. 12 is a rear elevational view of FIG. 9;

FIG. 13 is a left side elevational view of FIG. 9;

FIG. 14 is a right side elevational view of FIG. 9;

FIG. 15 is a top plan view of FIG. 9; and,

FIG. 16 is a bottom plan view of FIG. 9.

The broken lines are directed to environment and are provided for illustrative purpose only; the broken lines form no part of the claimed design.

1 Claim, 10 Drawing Sheets

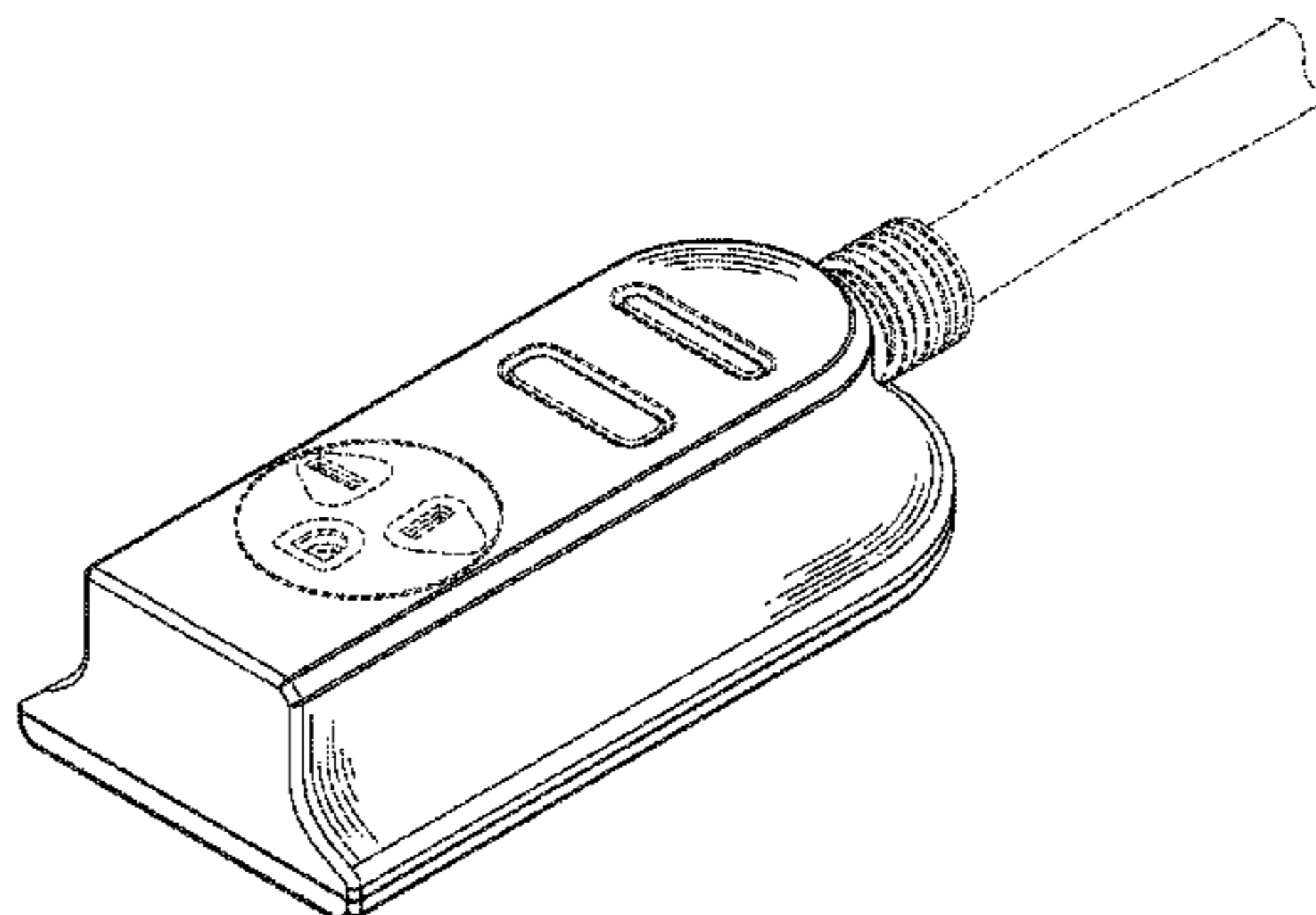
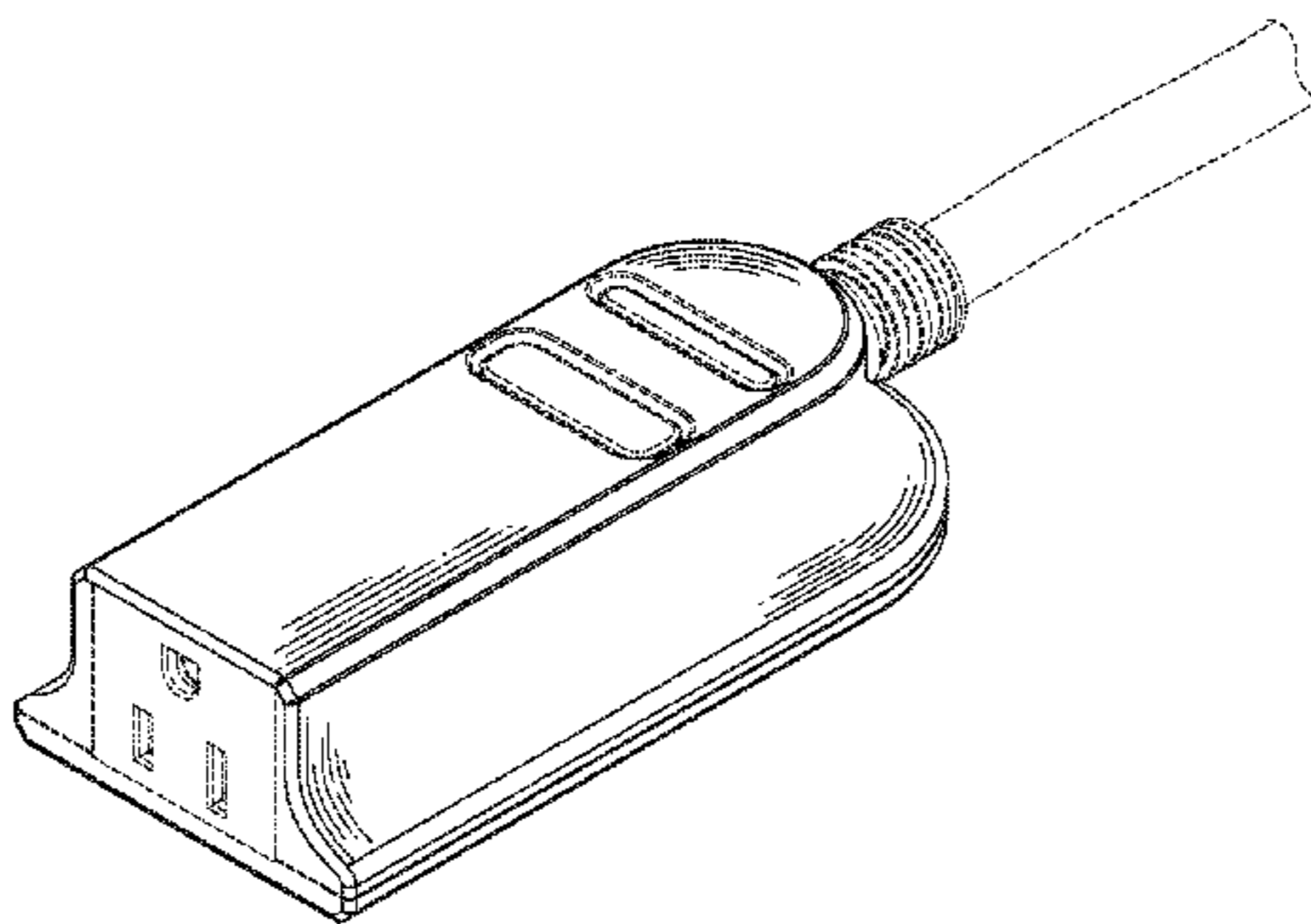

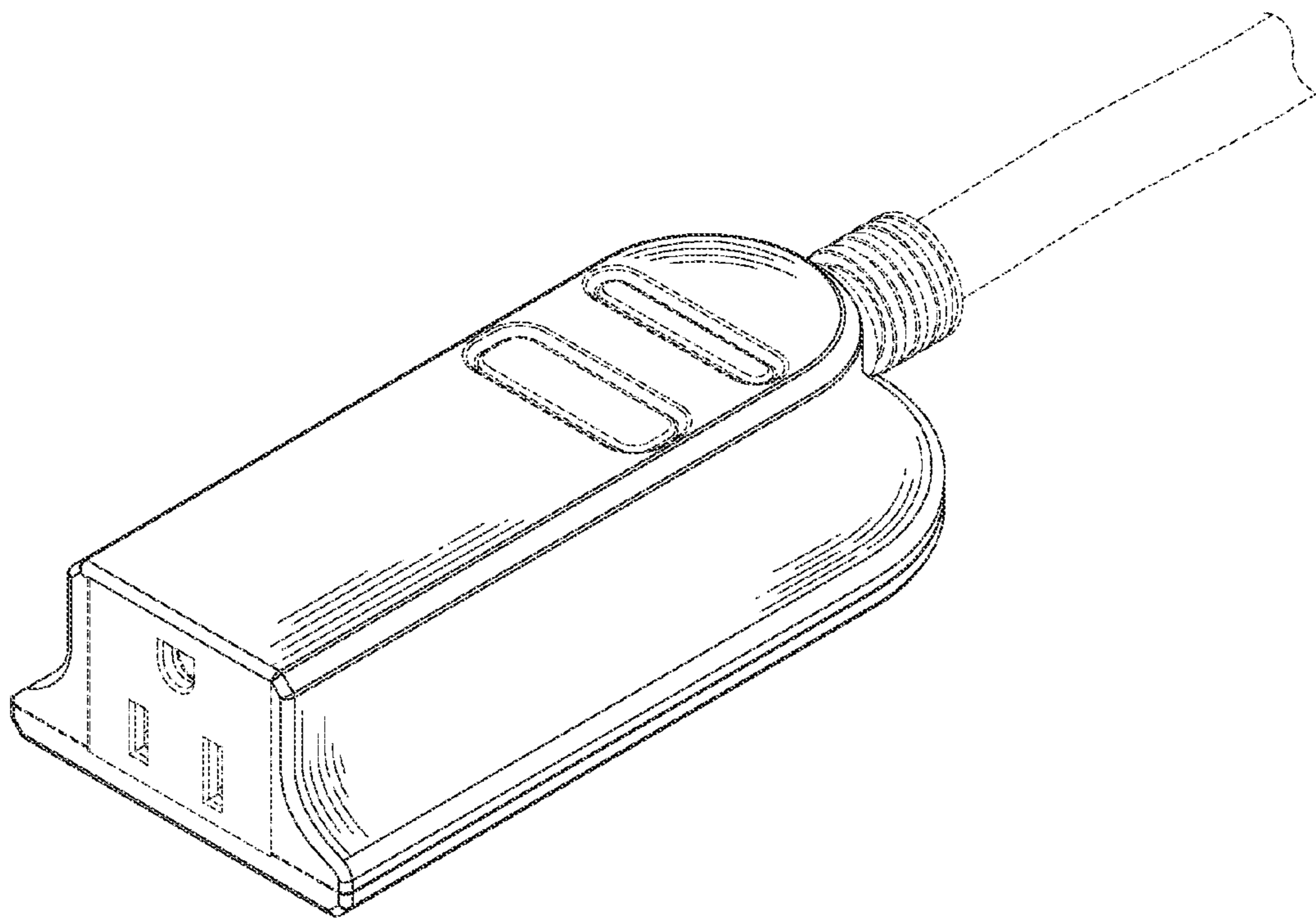

FIG.1

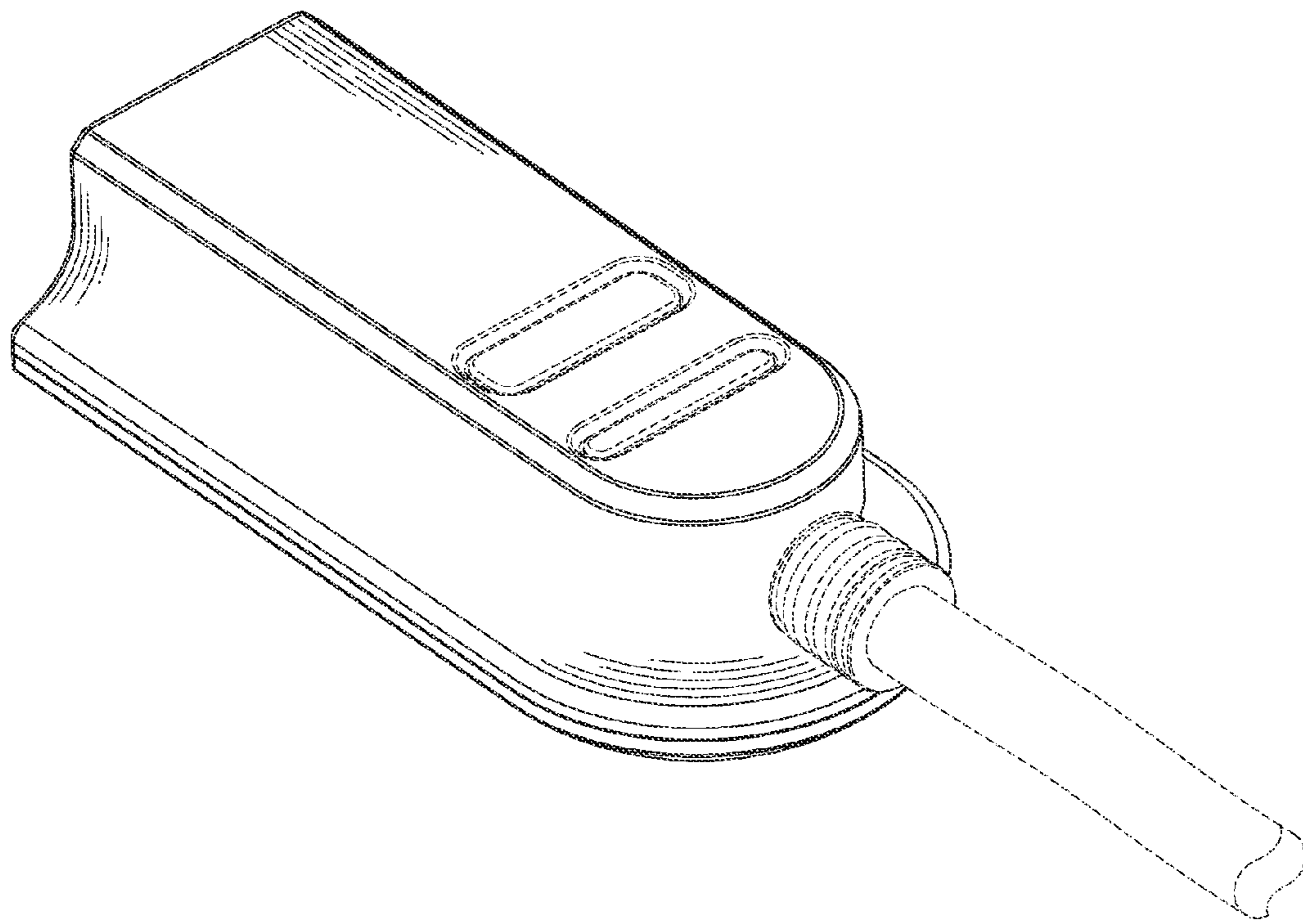

FIG.2

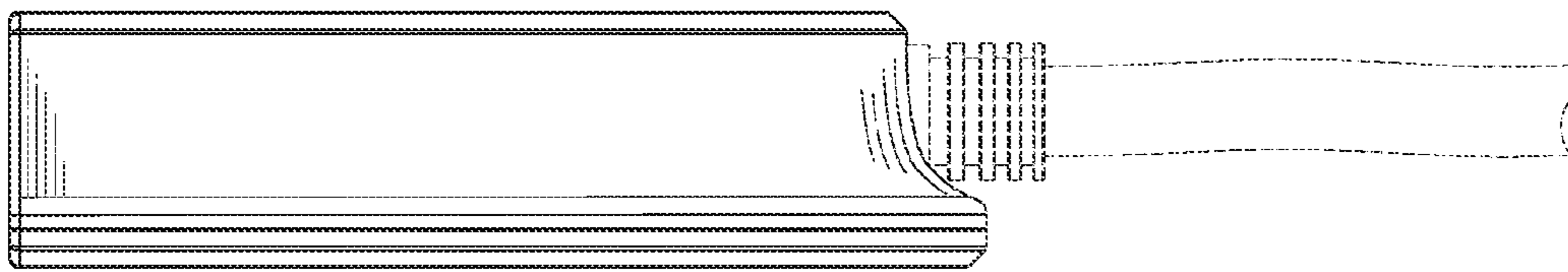

FIG.3

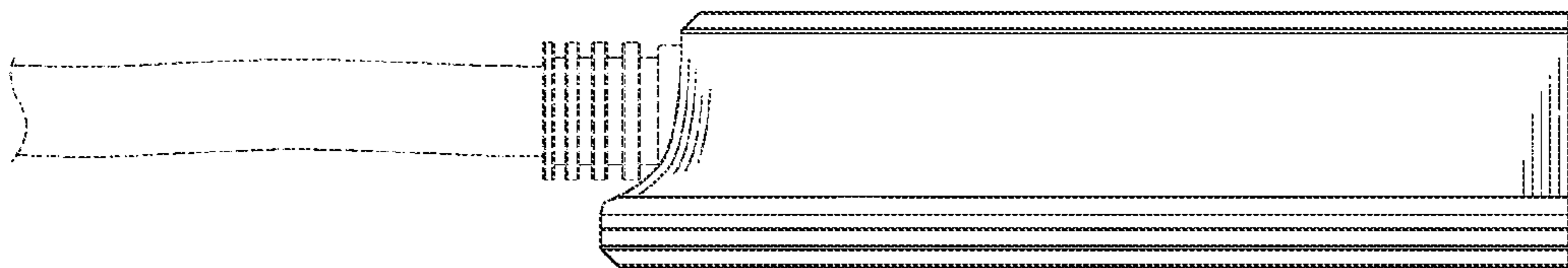

FIG.4

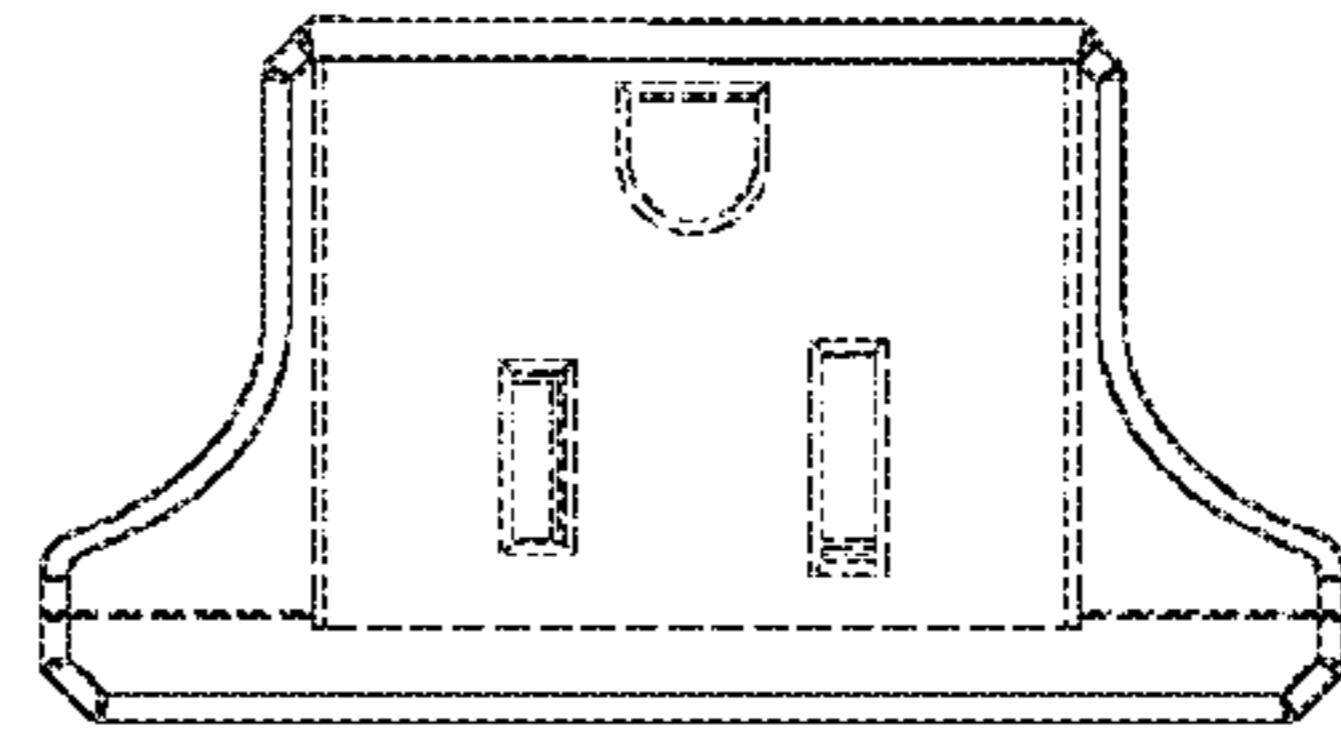

FIG. 5

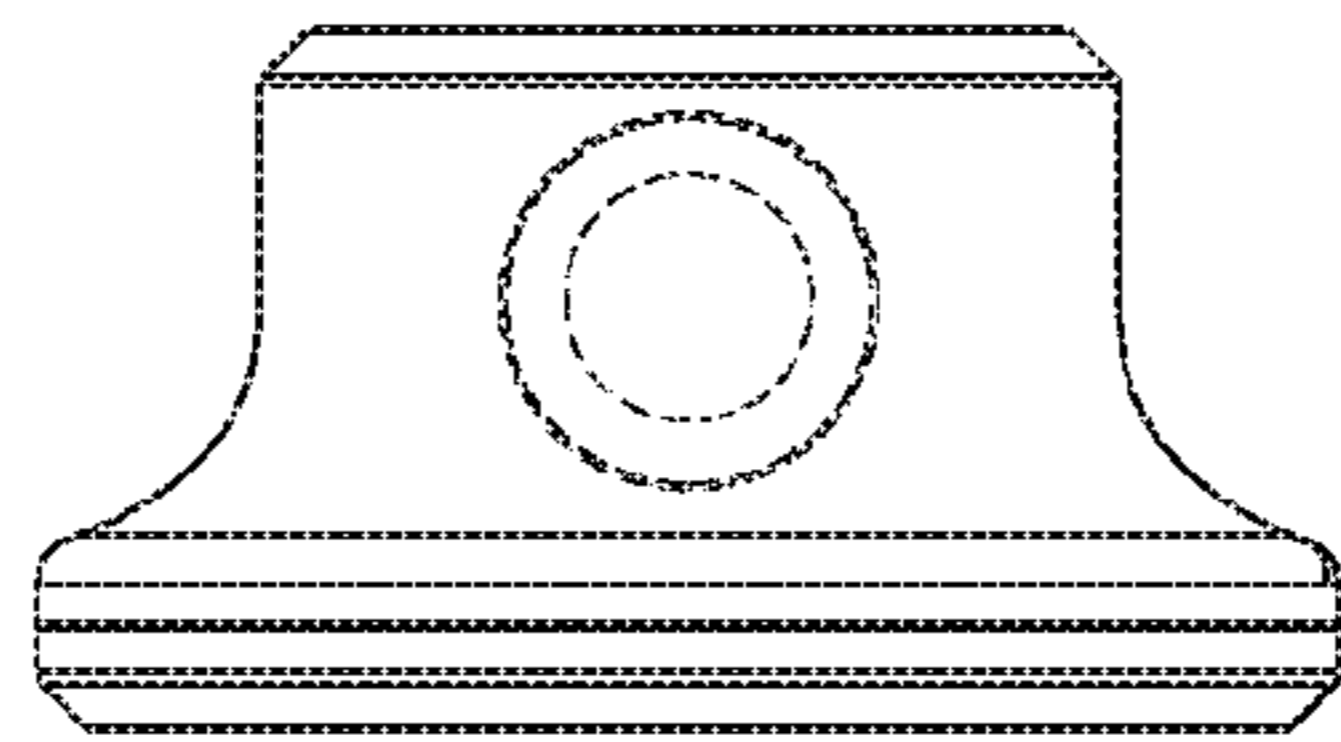

FIG. 6

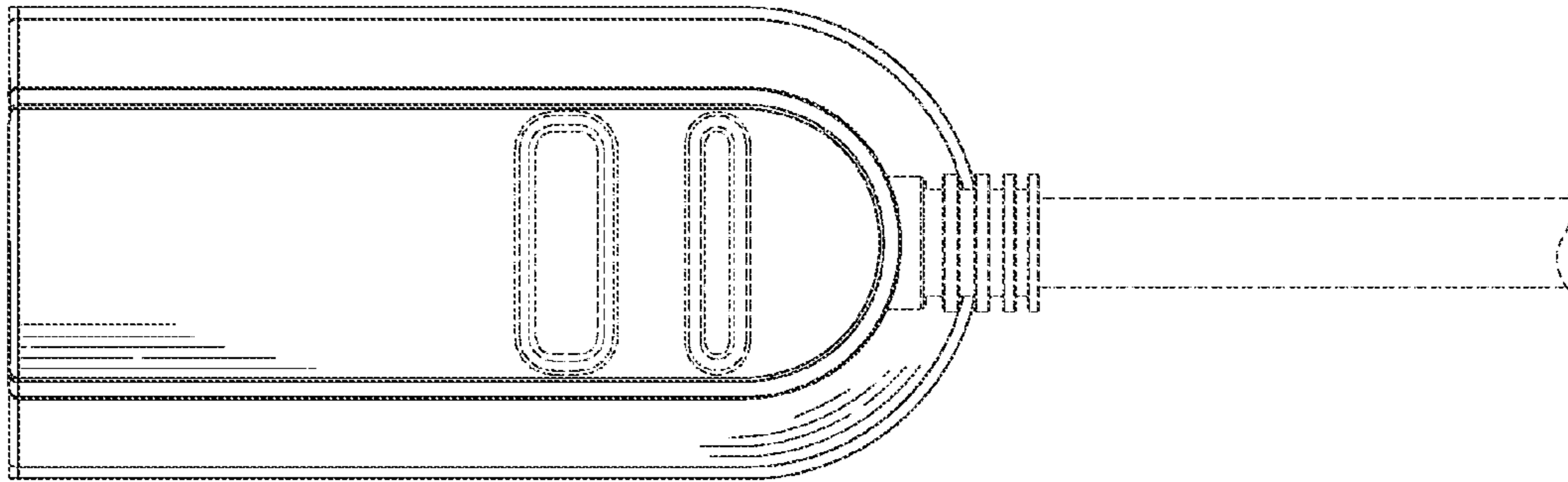

FIG. 7

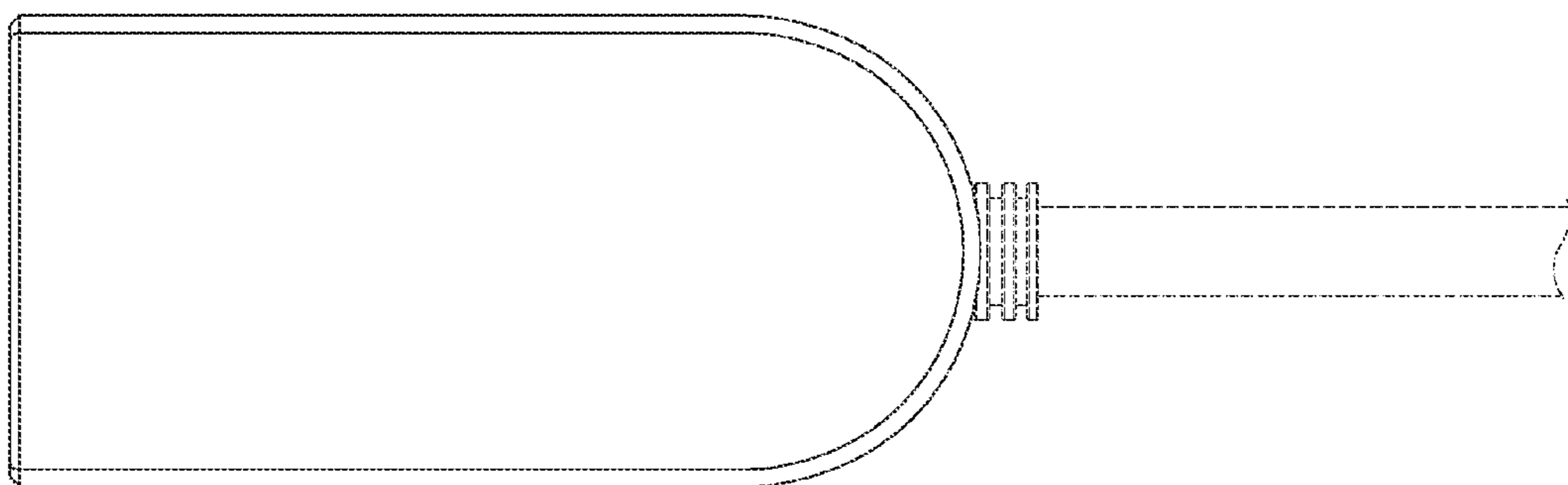

FIG. 8

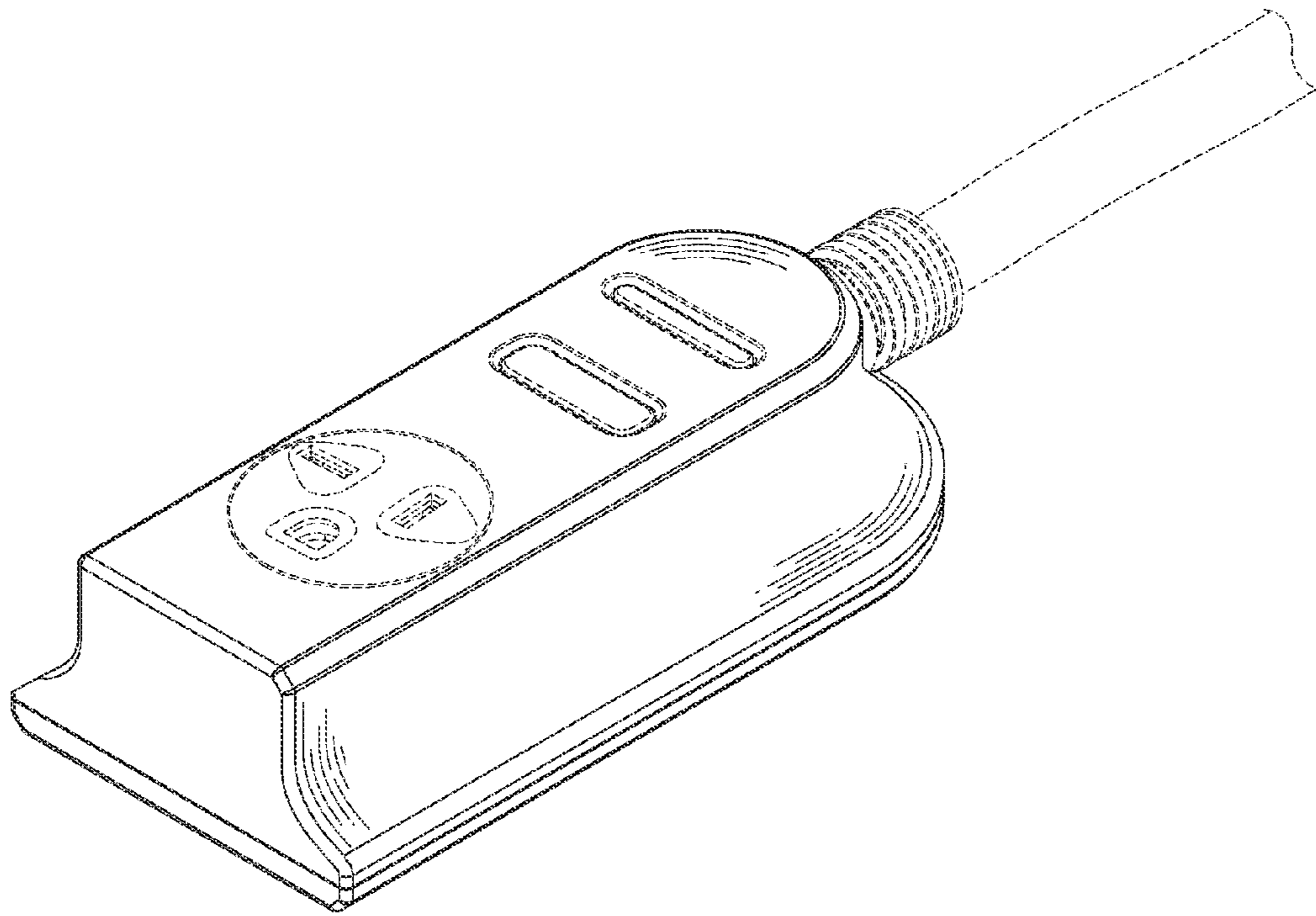

FIG.9

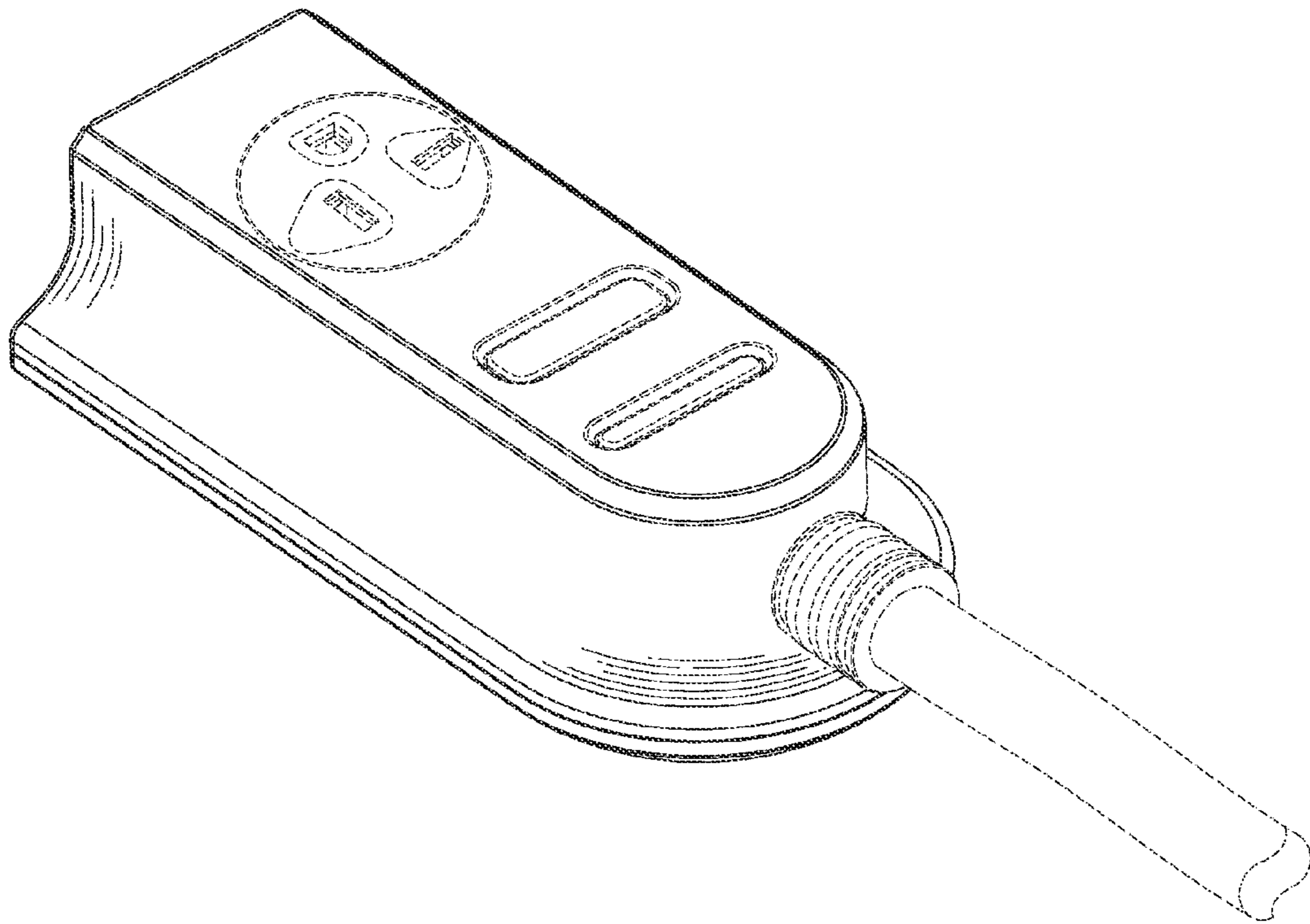

FIG. 10

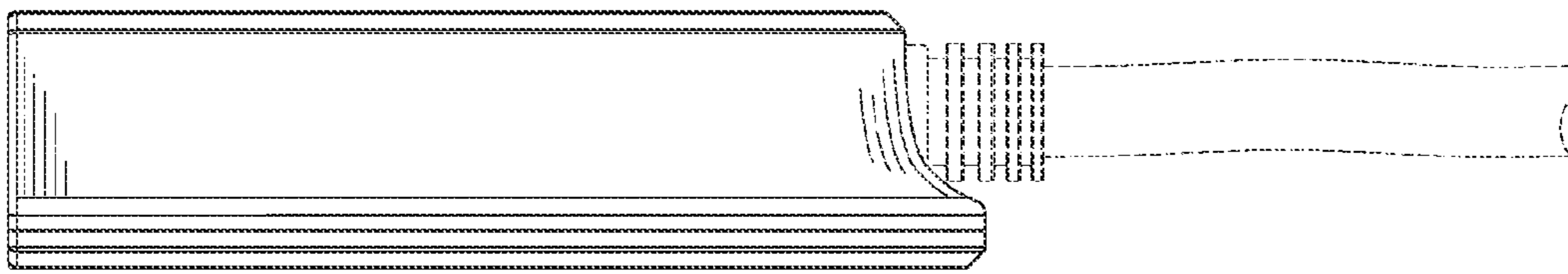

FIG. 11

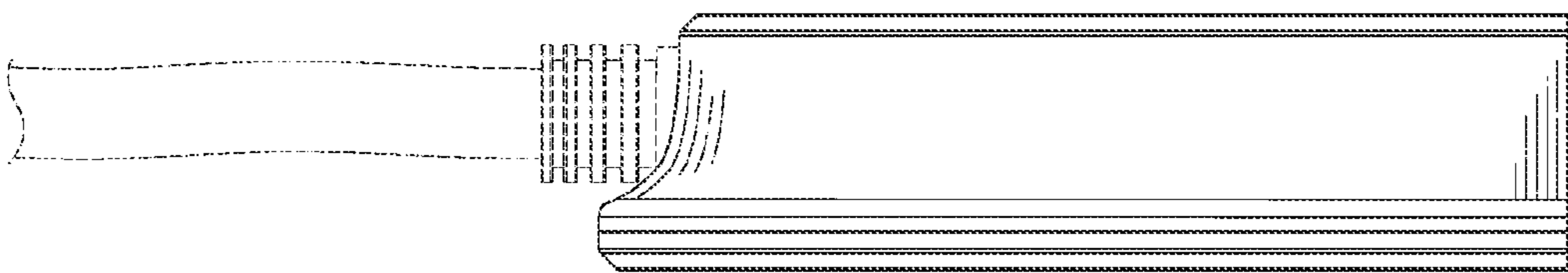

FIG. 12

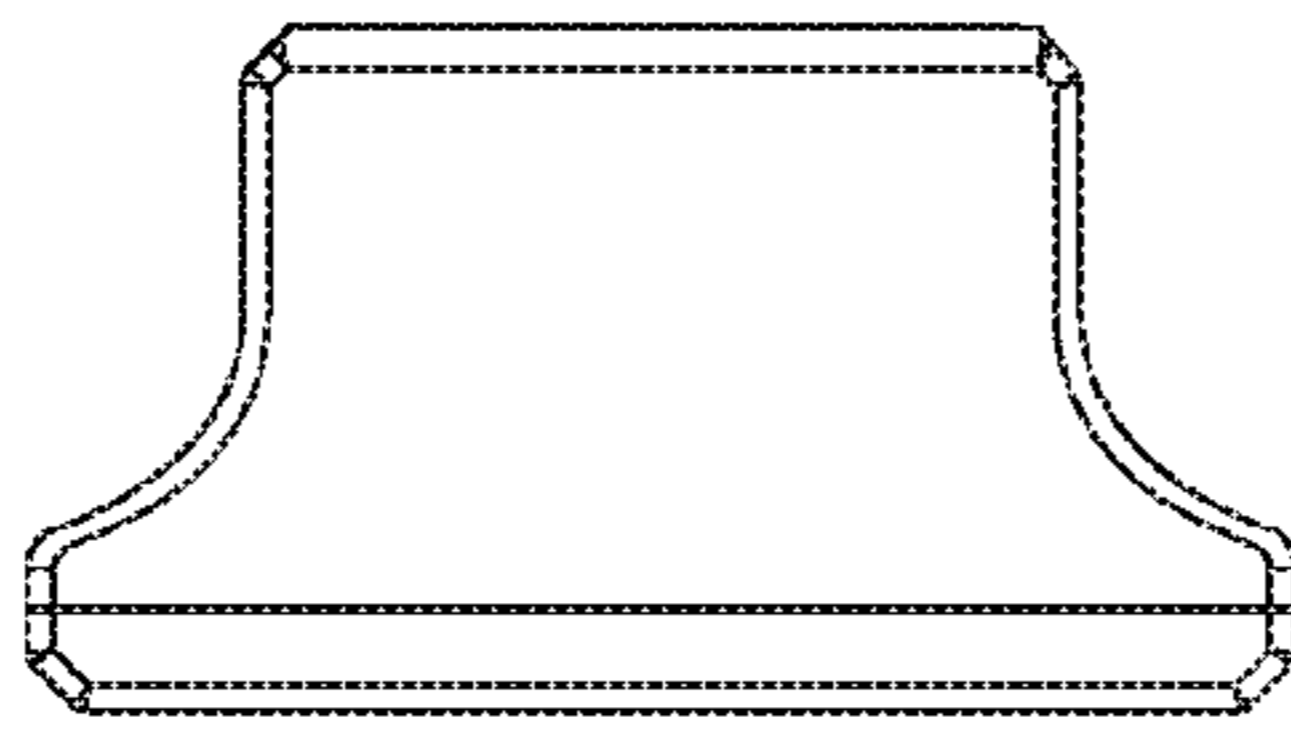

FIG. 13

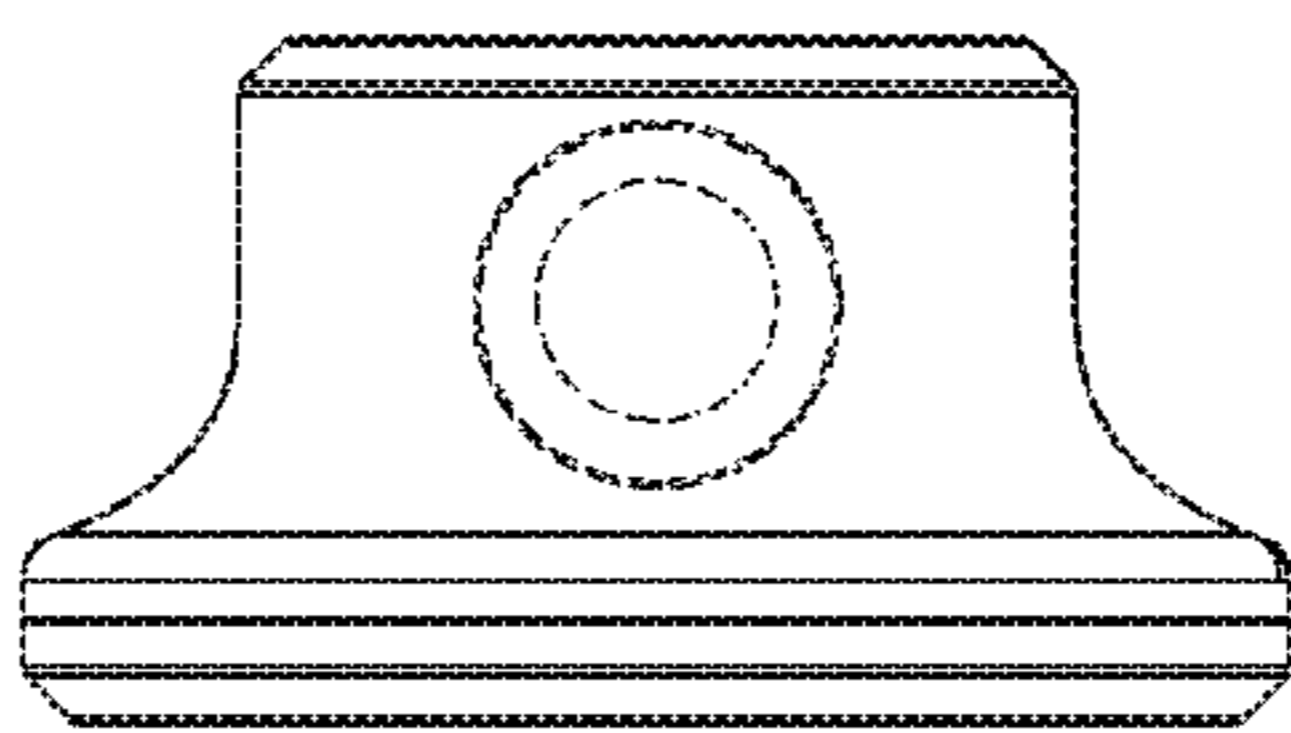

FIG. 14

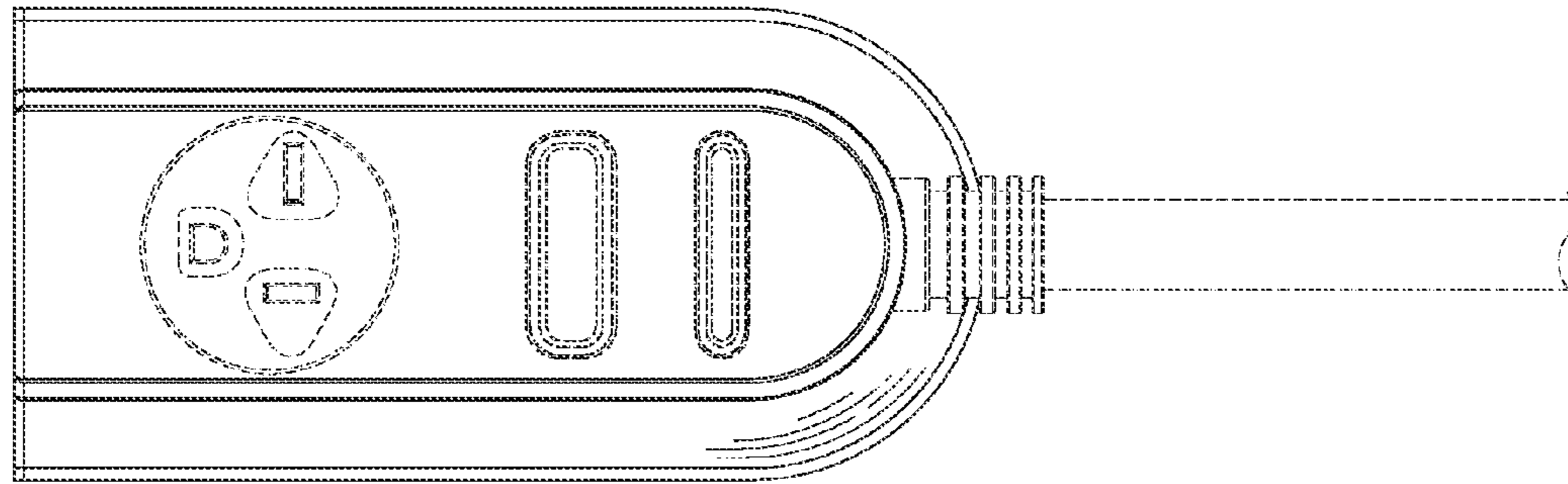

FIG. 15

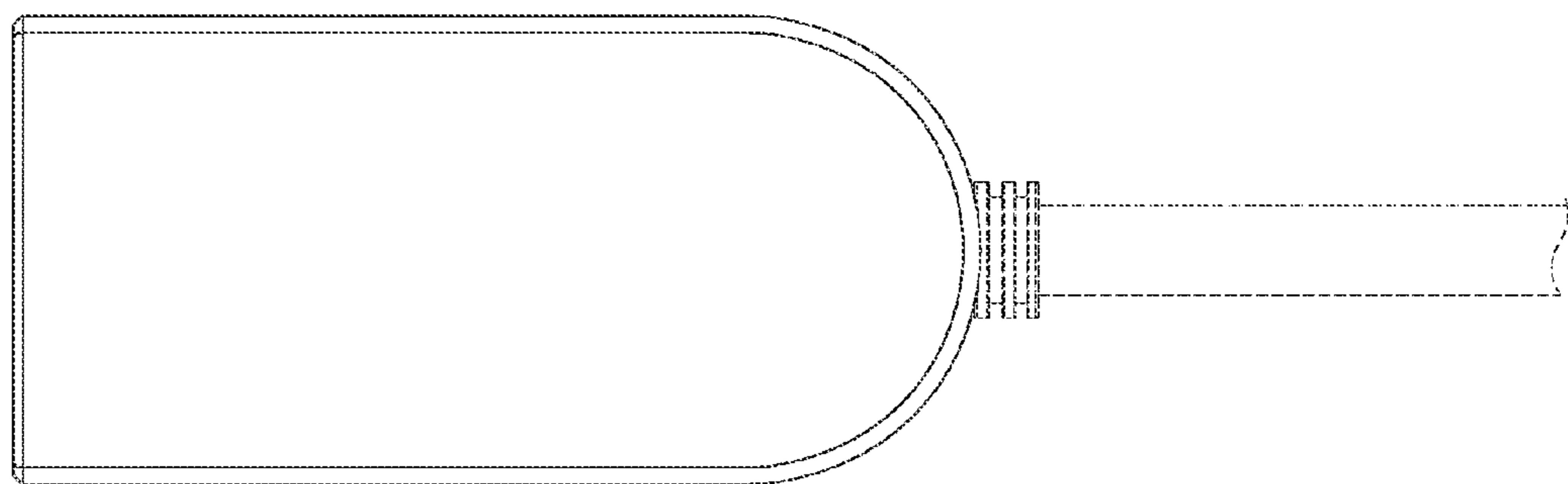

FIG. 16