



US00D693297S

(12) **United States Design Patent**
Inskeep

(10) **Patent No.:** **US D693,297 S**

(45) **Date of Patent:** **** Nov. 12, 2013**

(54) **PORTABLE POWER PACK**

(71) Applicant: **Mathew Inskeep**, Boca Raton, FL (US)

(72) Inventor: **Mathew Inskeep**, Boca Raton, FL (US)

(**) Term: **14 Years**

(21) Appl. No.: **29/450,396**

(22) Filed: **Mar. 18, 2013**

(51) **LOC (9) Cl.** **13-02**

(52) **U.S. Cl.**
USPC **D13/108; D13/103**

(58) **Field of Classification Search**
USPC D13/103, 107-110, 118-119, 184, 199;
D14/217, 251, 253, 432, 434;
320/107-115; 429/96-100, 163, 176
See application file for complete search history.

(56) **References Cited**

U.S. PATENT DOCUMENTS

D343,381 S *	1/1994	Inukai et al.	D13/107
D353,361 S *	12/1994	Nagele et al.	D13/103
D361,978 S *	9/1995	Shirai et al.	D13/103
D402,641 S *	12/1998	Heijnen	D13/184
D432,082 S *	10/2000	Chang	D13/123

D483,725 S *	12/2003	Thompson et al.	D13/184
D544,437 S *	6/2007	Hussaini et al.	D13/107
D548,181 S *	8/2007	Krieger et al.	D13/110
D550,613 S *	9/2007	Hamasaki	D13/103
D612,329 S *	3/2010	Guccione et al.	D13/108
D632,643 S *	2/2011	Tanaka et al.	D13/103
D639,736 S *	6/2011	Su	D13/110
D661,249 S *	6/2012	Smith et al.	D13/110
D676,380 S *	2/2013	Sun	D13/108
D682,777 S *	5/2013	Gupta et al.	D13/103

* cited by examiner

Primary Examiner — Rosemary K Tarcza

(57) **CLAIM**

I claim the ornamental design for a portable power pack, as shown in the attached drawings.

DESCRIPTION

FIG. 1 is a top perspective view of the portable power pack showing my new design.

FIG. 2 is a bottom perspective view.

FIG. 3 is a top view thereof.

FIG. 4 is a bottom view thereof.

FIG. 5 is a left side view.

FIG. 6 is a front view thereof; and,

FIG. 7 is a back view thereof.

1 Claim, 3 Drawing Sheets

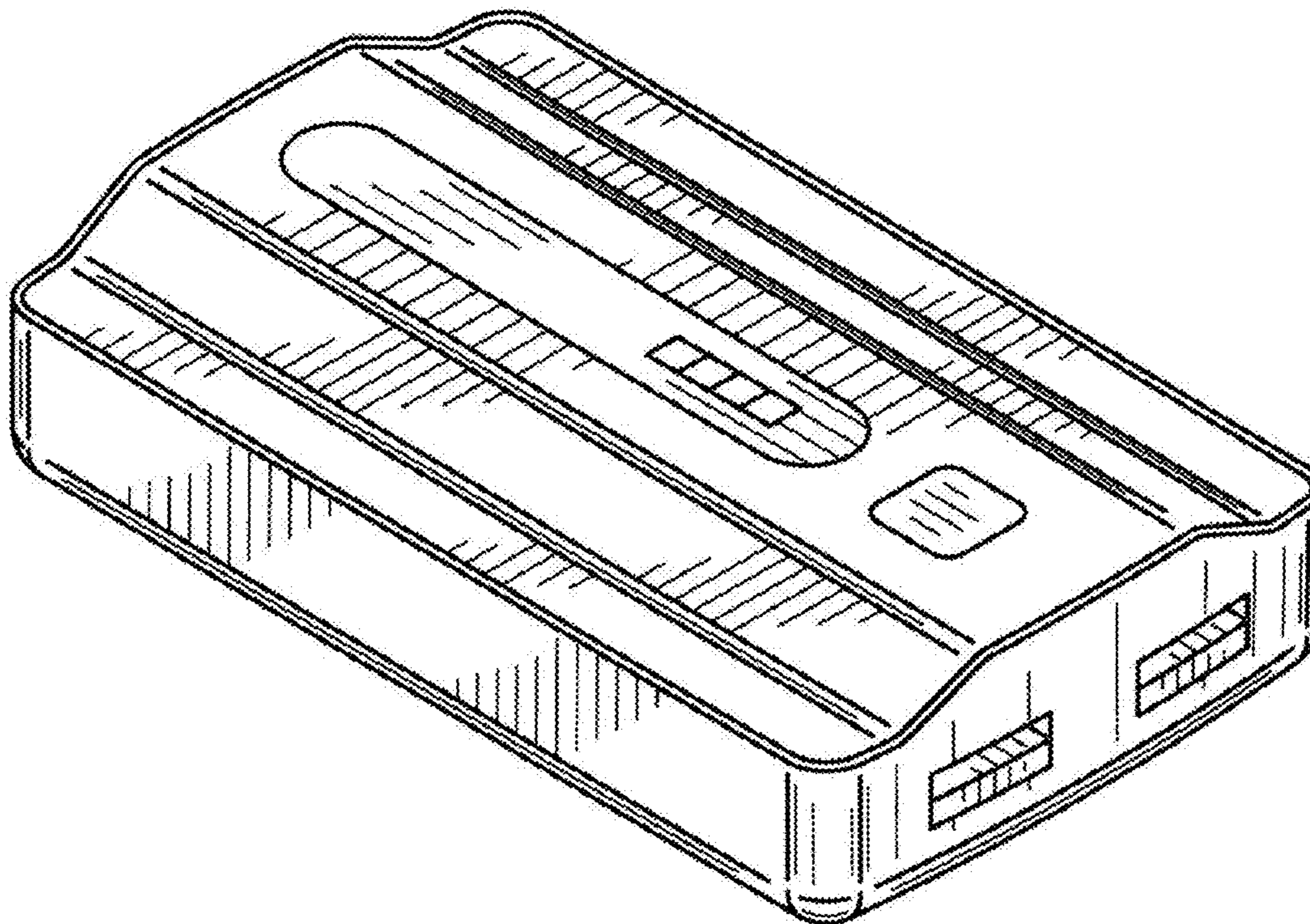

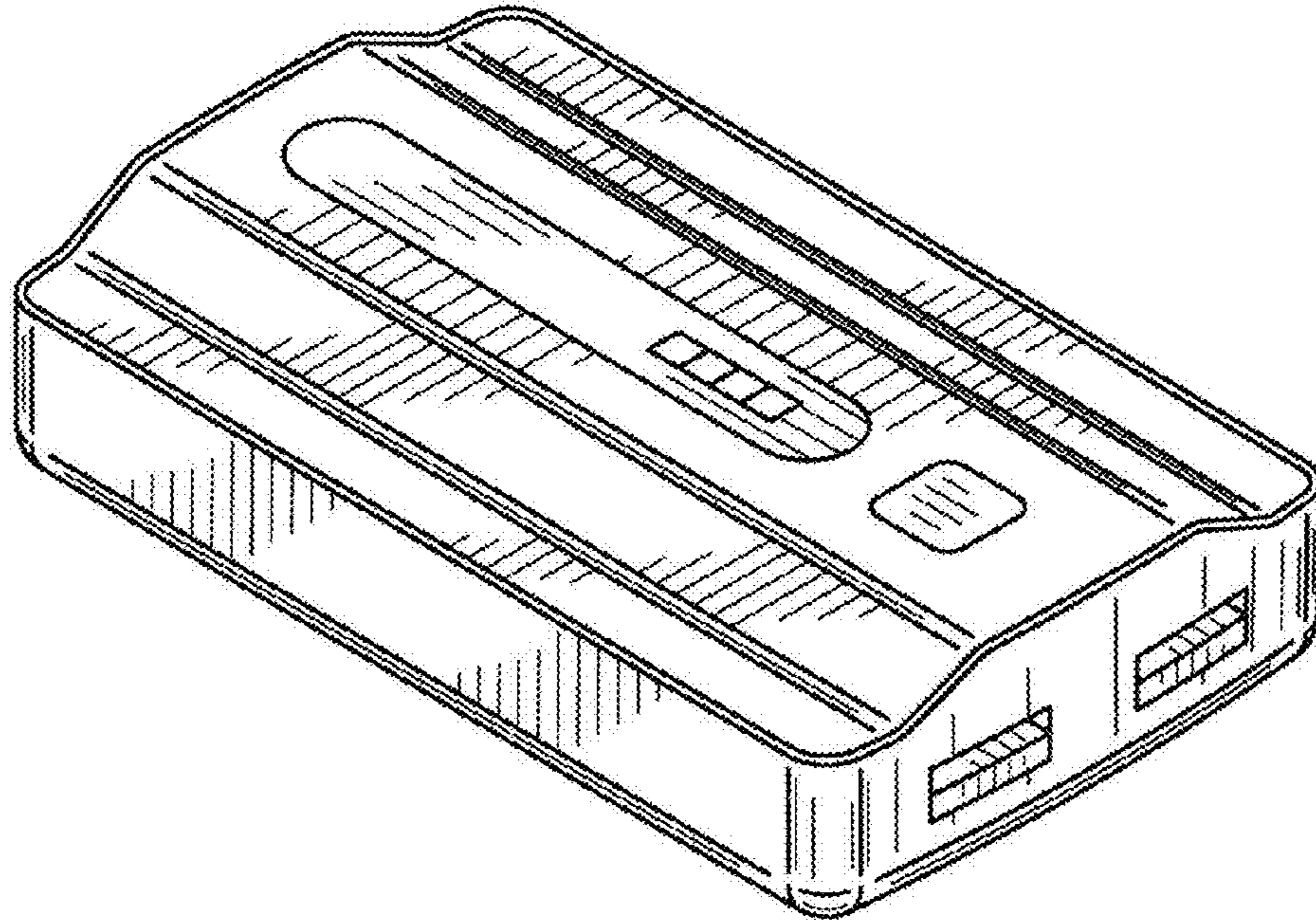

FIG. 1

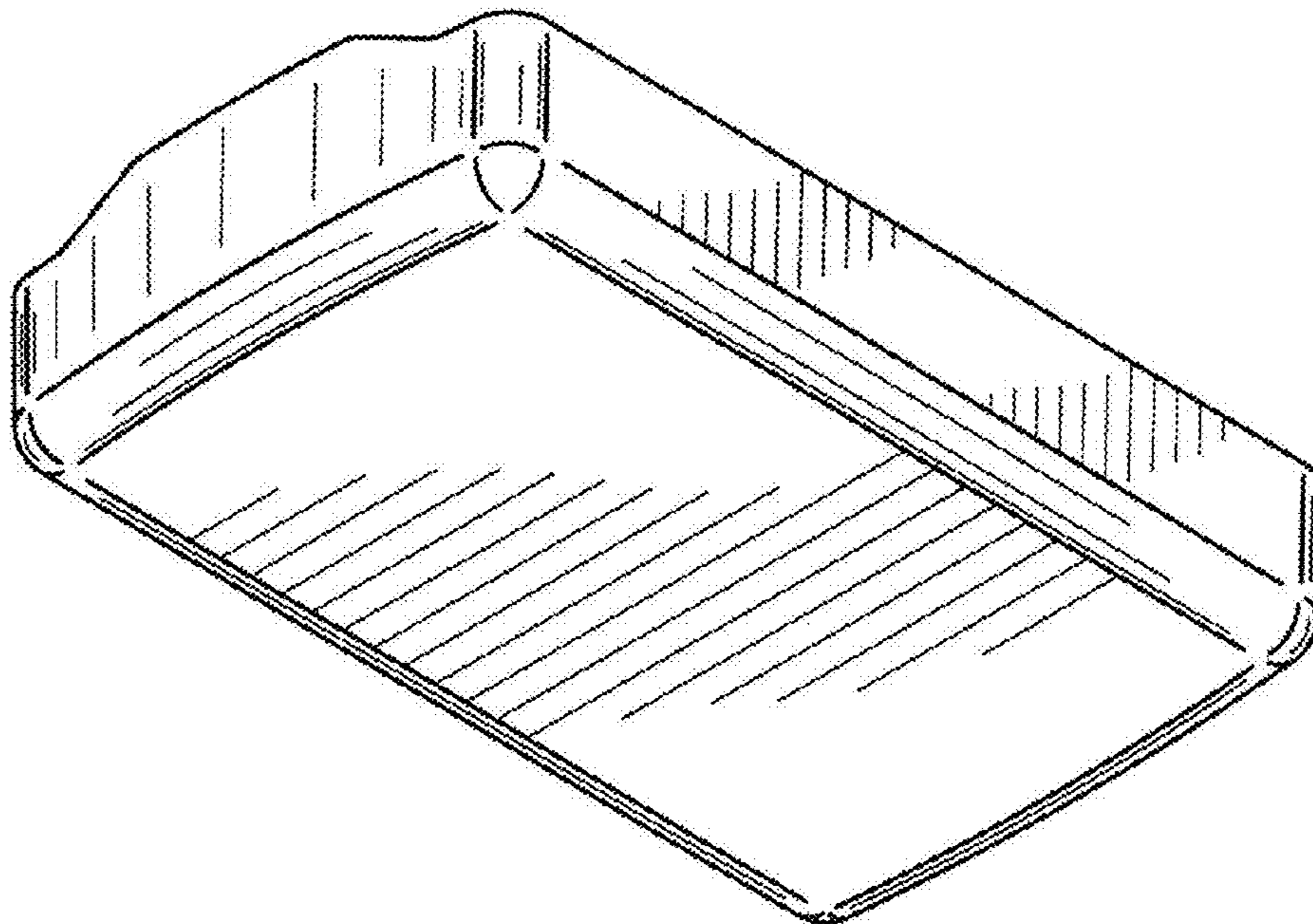

FIG. 2

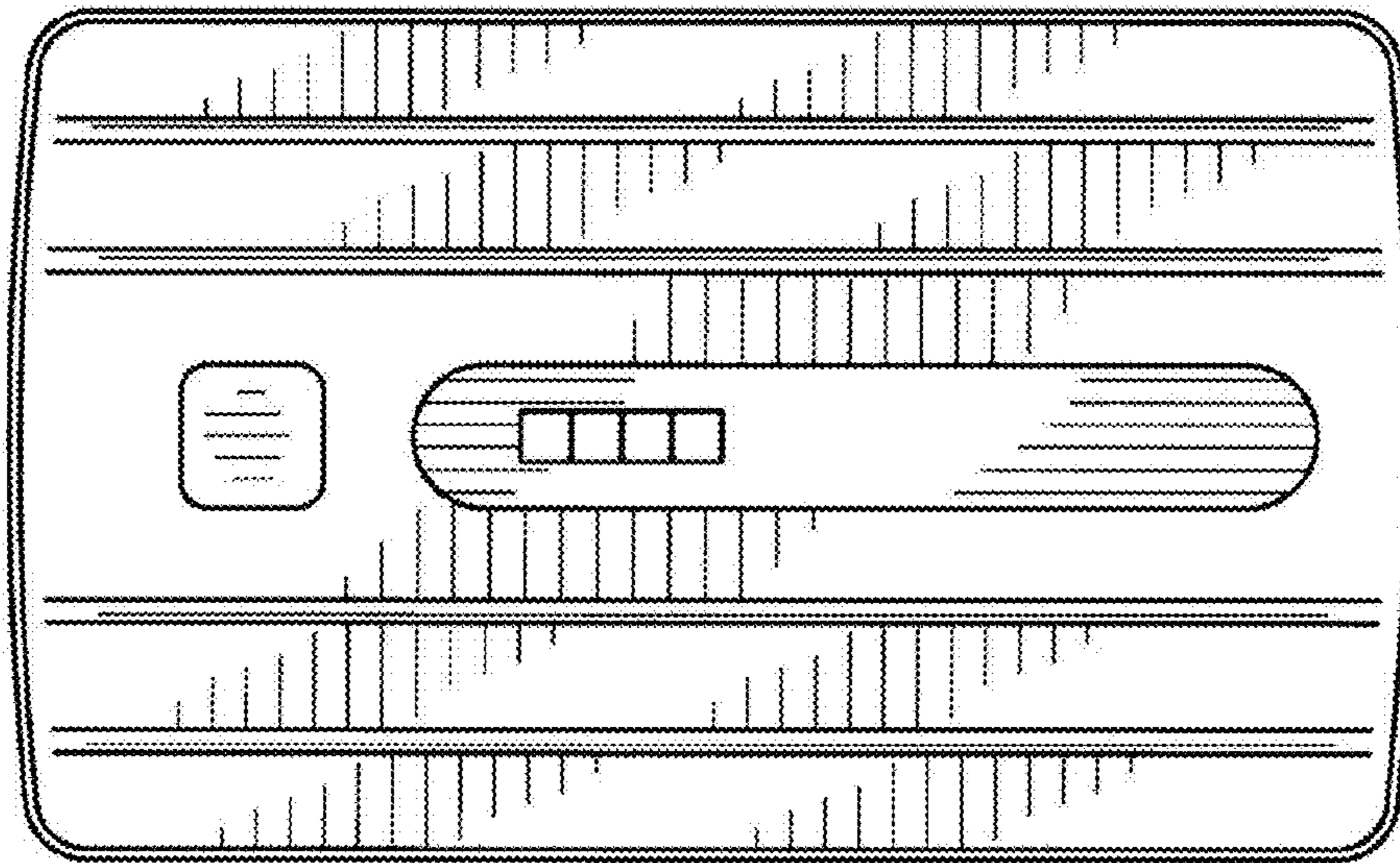

FIG. 3

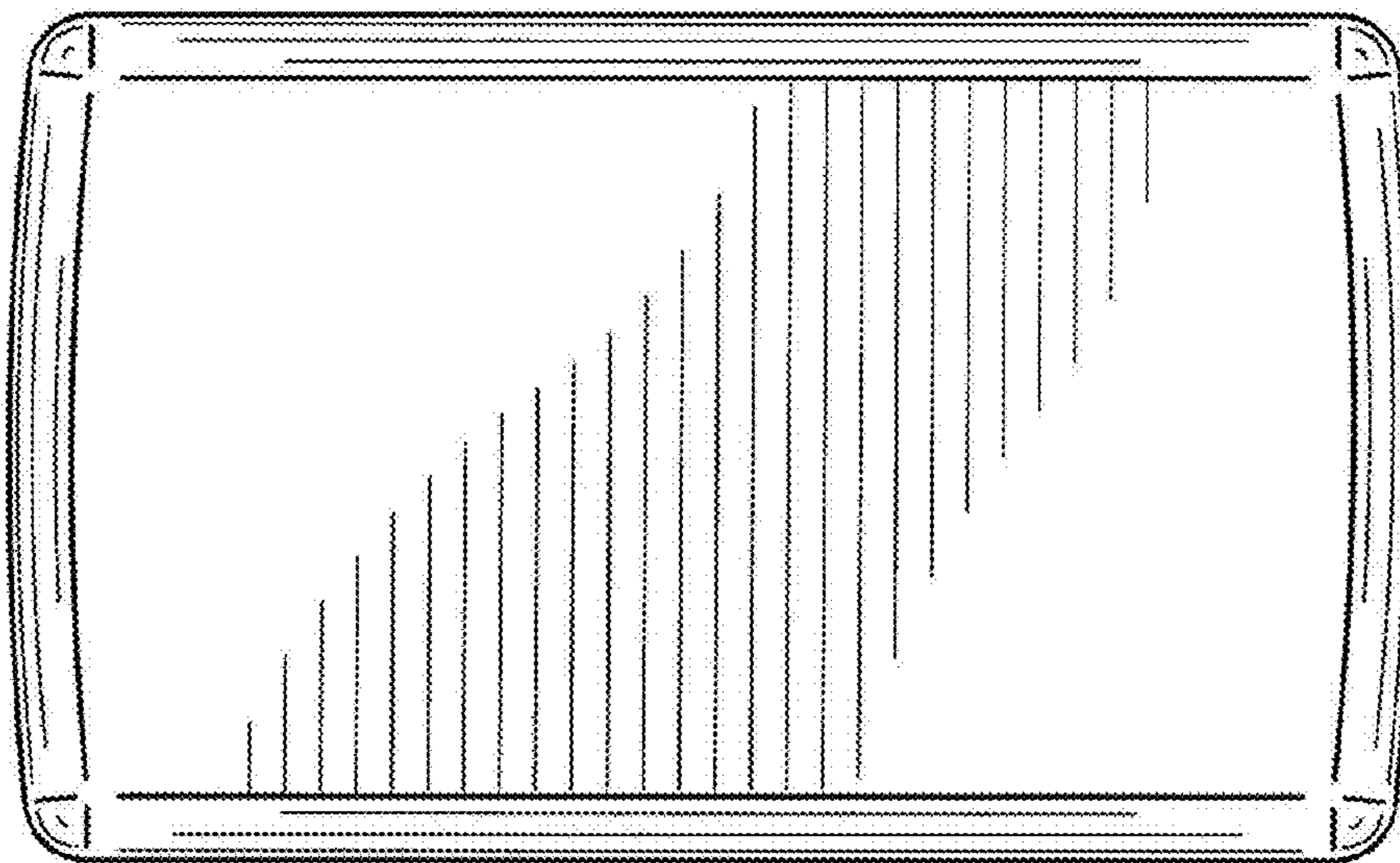

FIG. 4

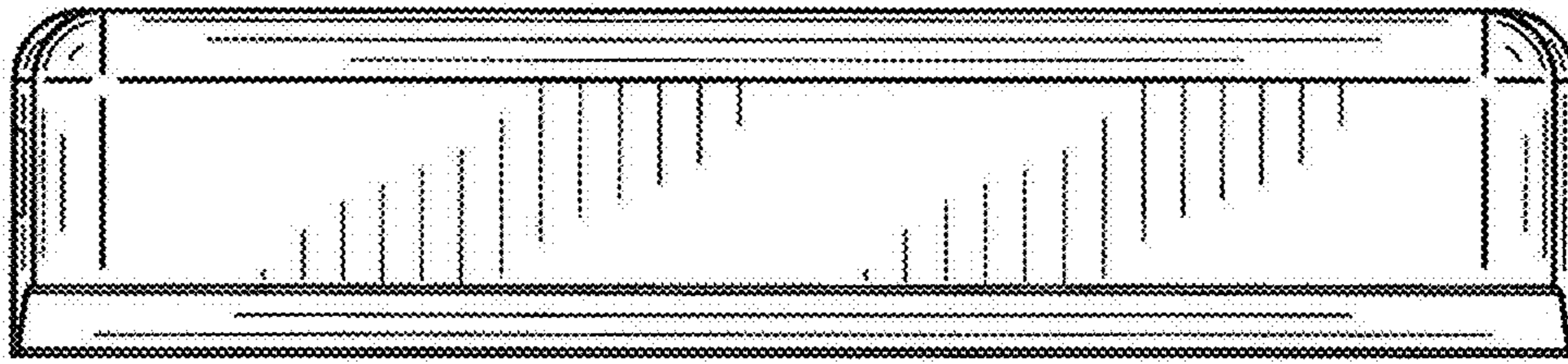

FIG. 5

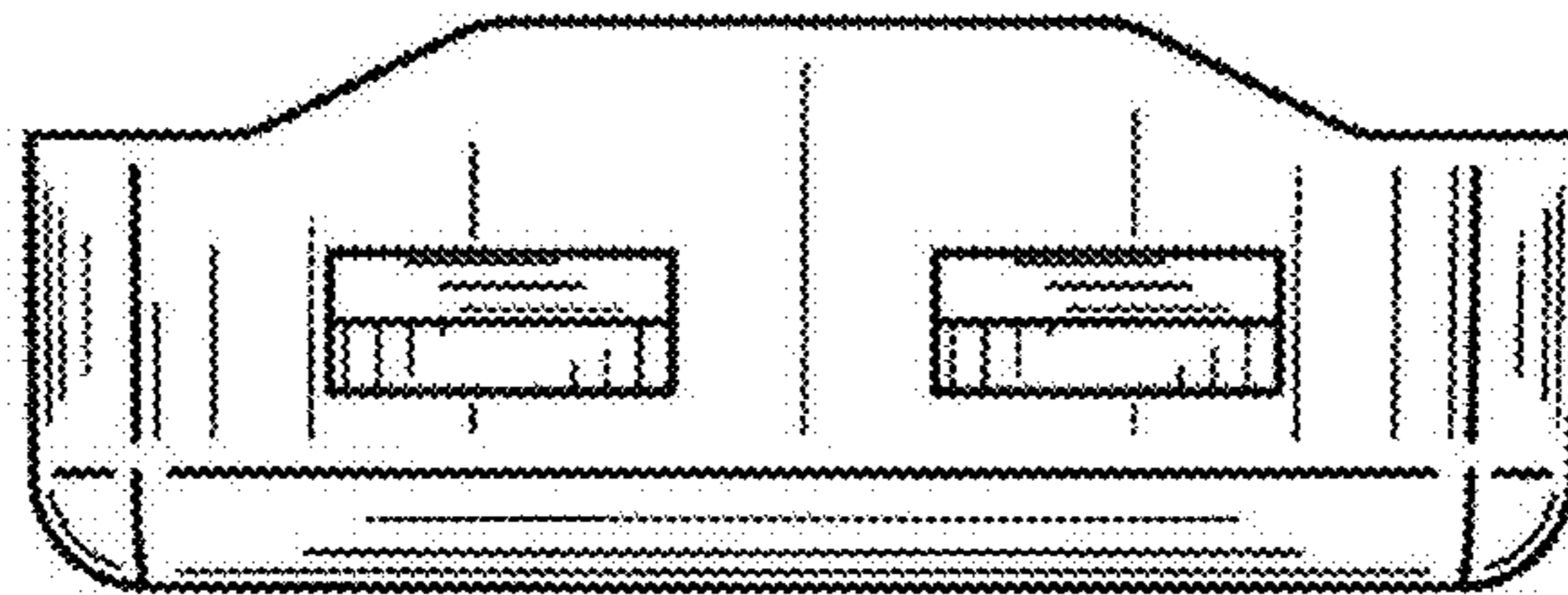

FIG. 6

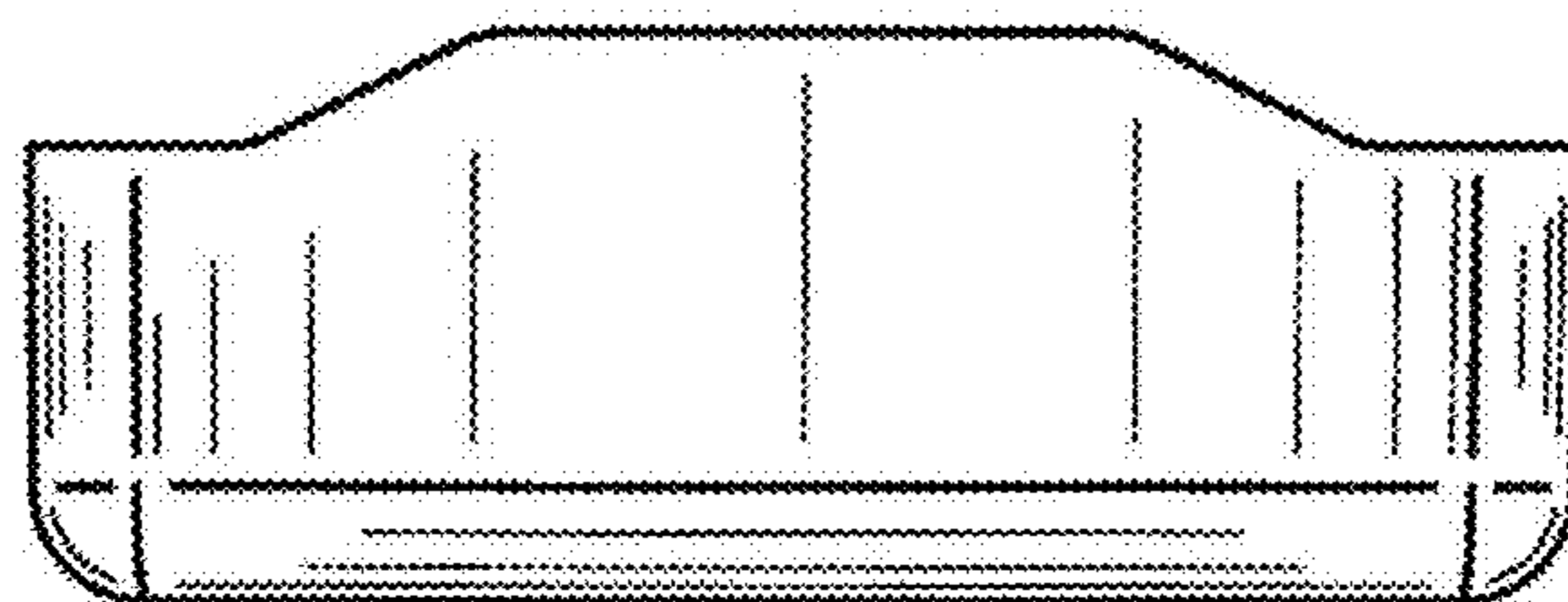

FIG. 7