



US00D693280S

(12) **United States Design Patent**  
**Shinagawa**

(10) **Patent No.:** **US D693,280 S**

(45) **Date of Patent:** **\*\* Nov. 12, 2013**

(54) **BRAKE DISC FOR A MOTORCYCLE**

(75) Inventor: **Yoshinori Shinagawa**, Takatsuki (JP)

(73) Assignee: **Sunstar Engineering Inc.**, Takatsuki-shi (JP)

(\*\*) Term: **14 Years**

(21) Appl. No.: **29/430,580**

(22) Filed: **Aug. 28, 2012**

(30) **Foreign Application Priority Data**

Feb. 28, 2012 (JP) ..... 2012-041019

Aug. 3, 2012 (JP) ..... 2012-172670

Aug. 3, 2012 (JP) ..... D2012-018619

(51) **LOC (9) Cl.** ..... **12-16**

(52) **U.S. Cl.**  
USPC ..... **D12/180**

(58) **Field of Classification Search**  
USPC ..... D12/179, 180, 110; 188/73.1, 73.2,  
188/71.1, 26, 344, 218 XL, 264 A,  
188/24.11-24.13, 264 AA, 250 E, 250 B,  
188/73.43, 73.45; 192/70.16; 180/219, 220  
See application file for complete search history.

(56) **References Cited**

**U.S. PATENT DOCUMENTS**

D581,329 S *	11/2008	Ohigashi et al. ....	D12/180
8,353,391 B2 *	1/2013	Fujita et al. ....	188/218 XL
2005/0161296 A1 *	7/2005	Okabe ..... ..	188/218 XL
2006/0272906 A1 *	12/2006	Gonska ..... ..	188/218 XL
2007/0102247 A1 *	5/2007	Takenaka et al. ....	188/26
2008/0185945 A1 *	8/2008	Low ..... ..	312/257.1
2008/0302616 A1 *	12/2008	Kao ..... ..	188/218 XL
2010/0051398 A1 *	3/2010	Spacek ..... ..	188/218 XL
2010/0101902 A1 *	4/2010	Kano et al. ....	188/218 XL
2010/0282551 A1 *	11/2010	Ruopp et al. ....	188/218 XL

**OTHER PUBLICATIONS**

Brake Rotor on p. 2 of 5. [Retrieved on Mar. 25, 2013,]. Retrieved from the internet: [http://www.motorcyclepowersportsnews.com/item/84988/stopping\\_power.aspx](http://www.motorcyclepowersportsnews.com/item/84988/stopping_power.aspx).\*

Custom Chrome® 2005 catalog, brake rotor on pp. 13.70 and 13.73 .Brake Rotor on p. 2 of 5. [Retrieved on Mar. 25, 2013,]. Retrieved from the internet: [http://www.motorcyclepowersportsnews.com/item/84988/stopping\\_power.aspx](http://www.motorcyclepowersportsnews.com/item/84988/stopping_power.aspx).\*

\* cited by examiner

*Primary Examiner* — Susan M Lee

*Assistant Examiner* — Linda Brooks

(74) *Attorney, Agent, or Firm* — Kratz, Quintos & Hanson, LLP

(57) **CLAIM**

The ornamental design for a brake disc for a motorcycle, as shown and described.

**DESCRIPTION**

FIG. 1 is a perspective view of the front side of the brake disc of the present invention;

FIG. 2 is a perspective view of the back side thereof;

FIG. 3 is a front view thereof;

FIG. 4 is a back view thereof;

FIG. 5 is a right side view thereof;

FIG. 6 is a left side view thereof;

FIG. 7 is a plan view thereof;

FIG. 8 is a bottom view thereof;

FIG. 9 is a cross-sectional view taken along lines 9-9 of FIG. 3;

FIG. 10 is an enlarged view of the portion of FIG. 9 taken along lines 10-10 thereof;

FIG. 11 is an enlarged perspective view of the sold line portion of FIG. 1; and,

FIG. 12 is an enlarged perspective view of the sold line portion of FIG. 2.

The broken lines shown in the drawings are included for the purpose of illustrating environmental structure and form no part of the claimed design.

**1 Claim, 12 Drawing Sheets**

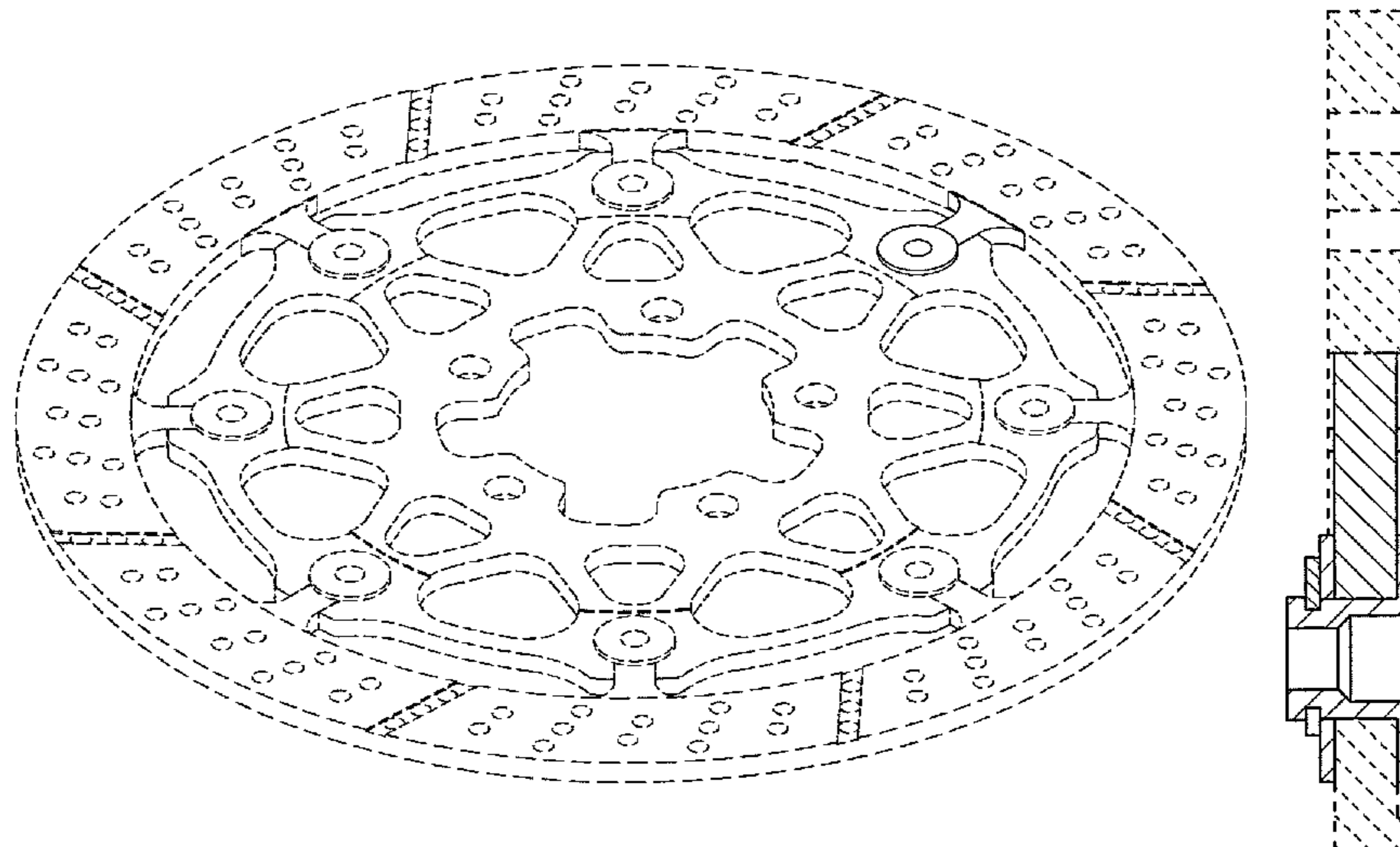

FIG. 1

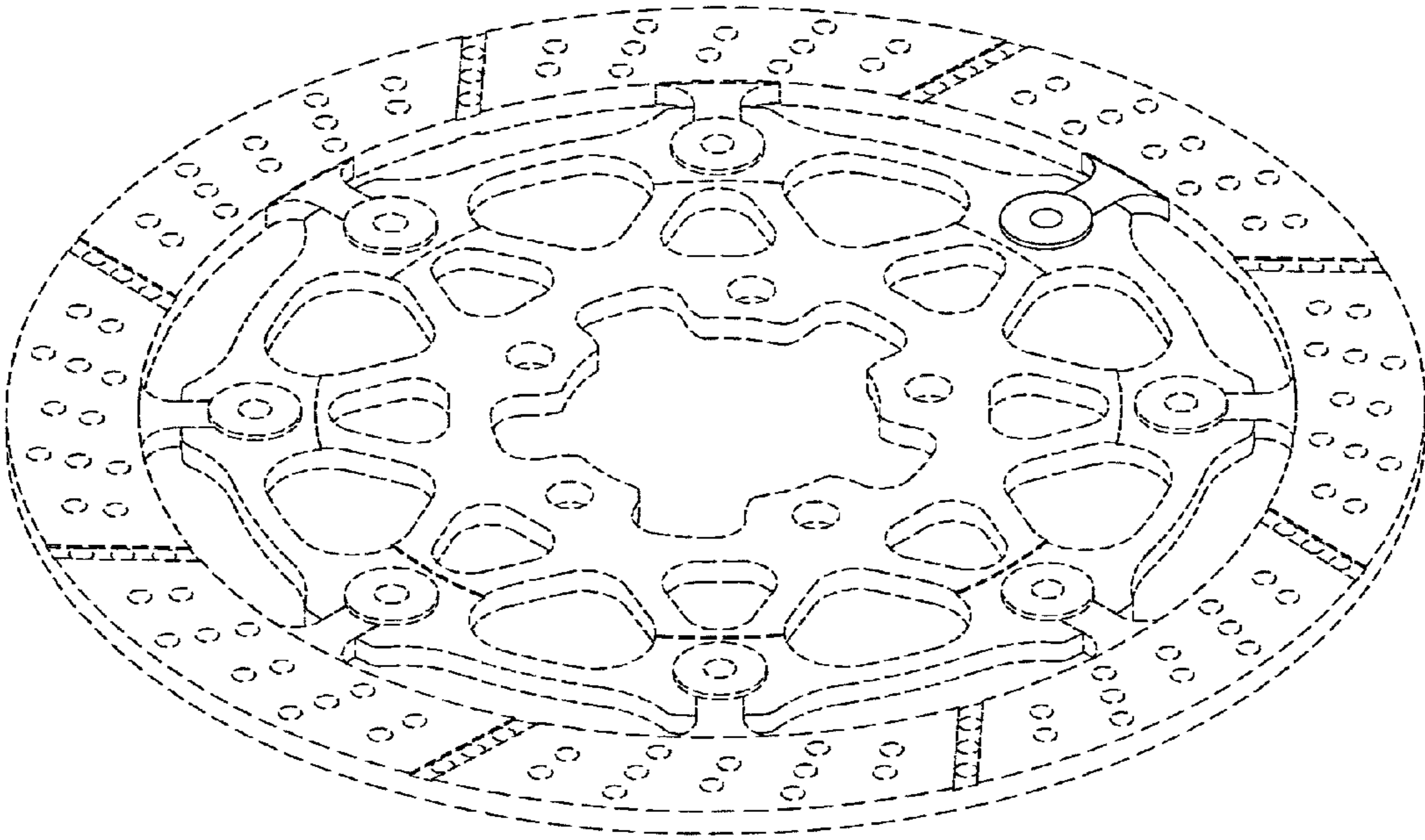

FIG. 2

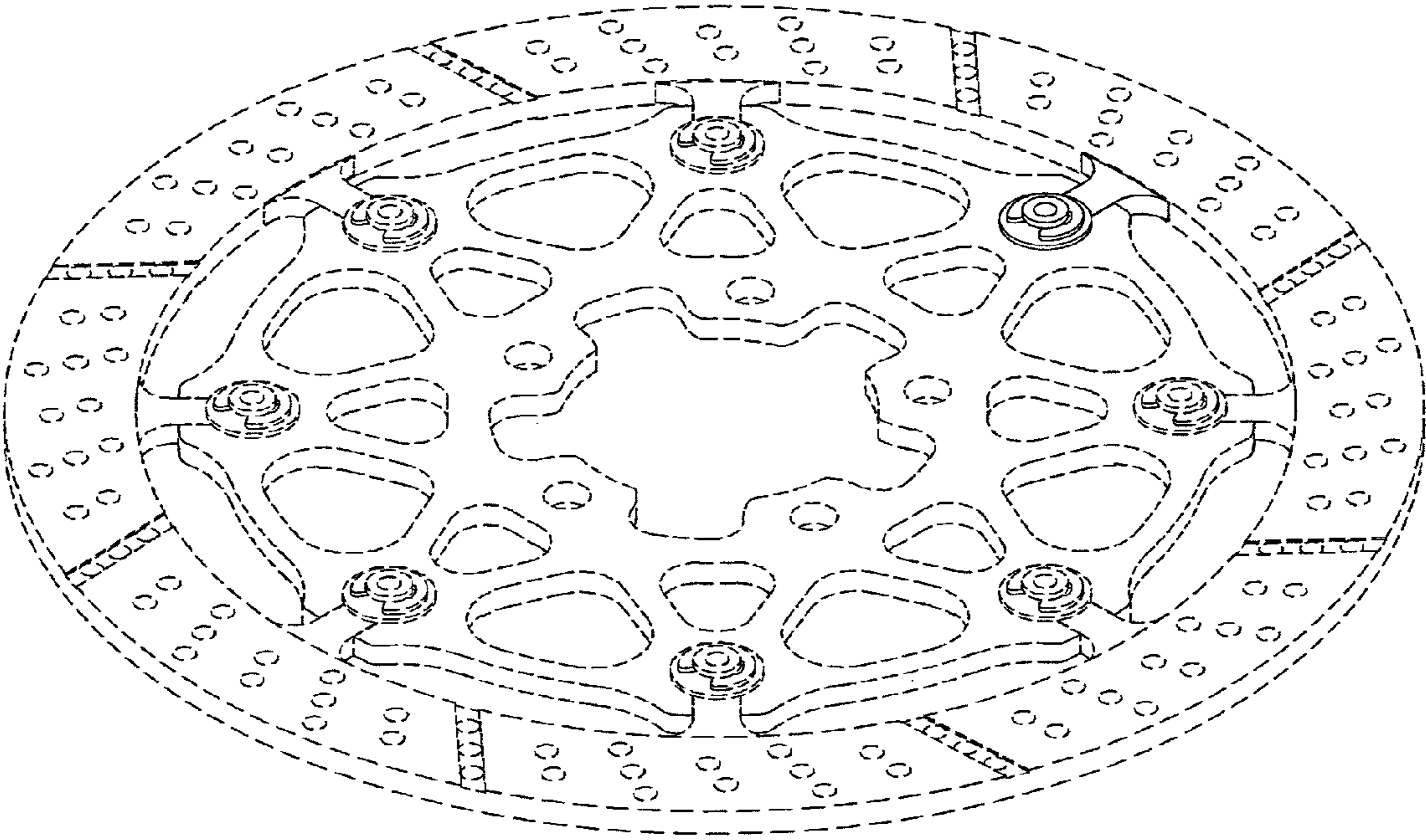

FIG. 3

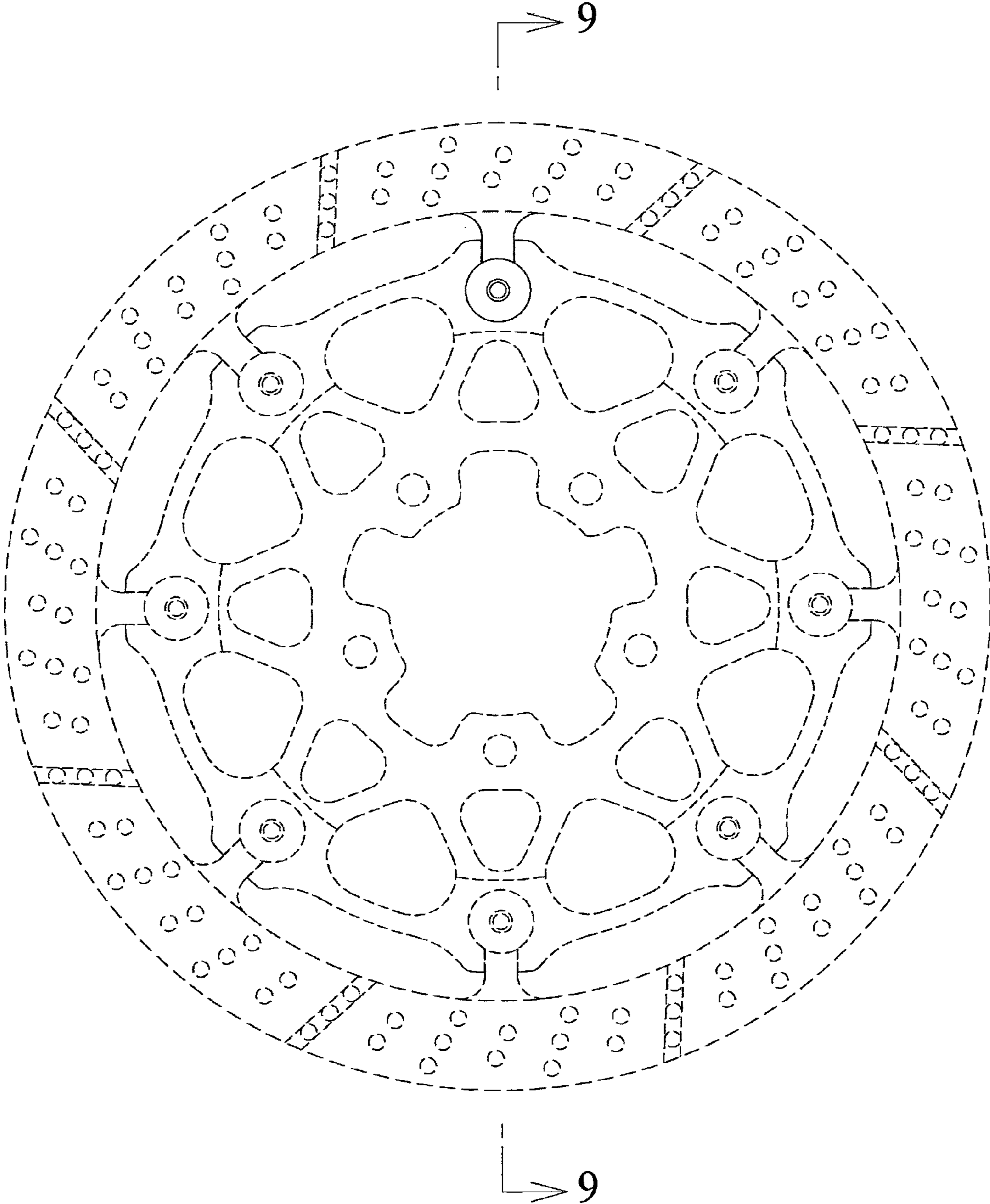

FIG. 4

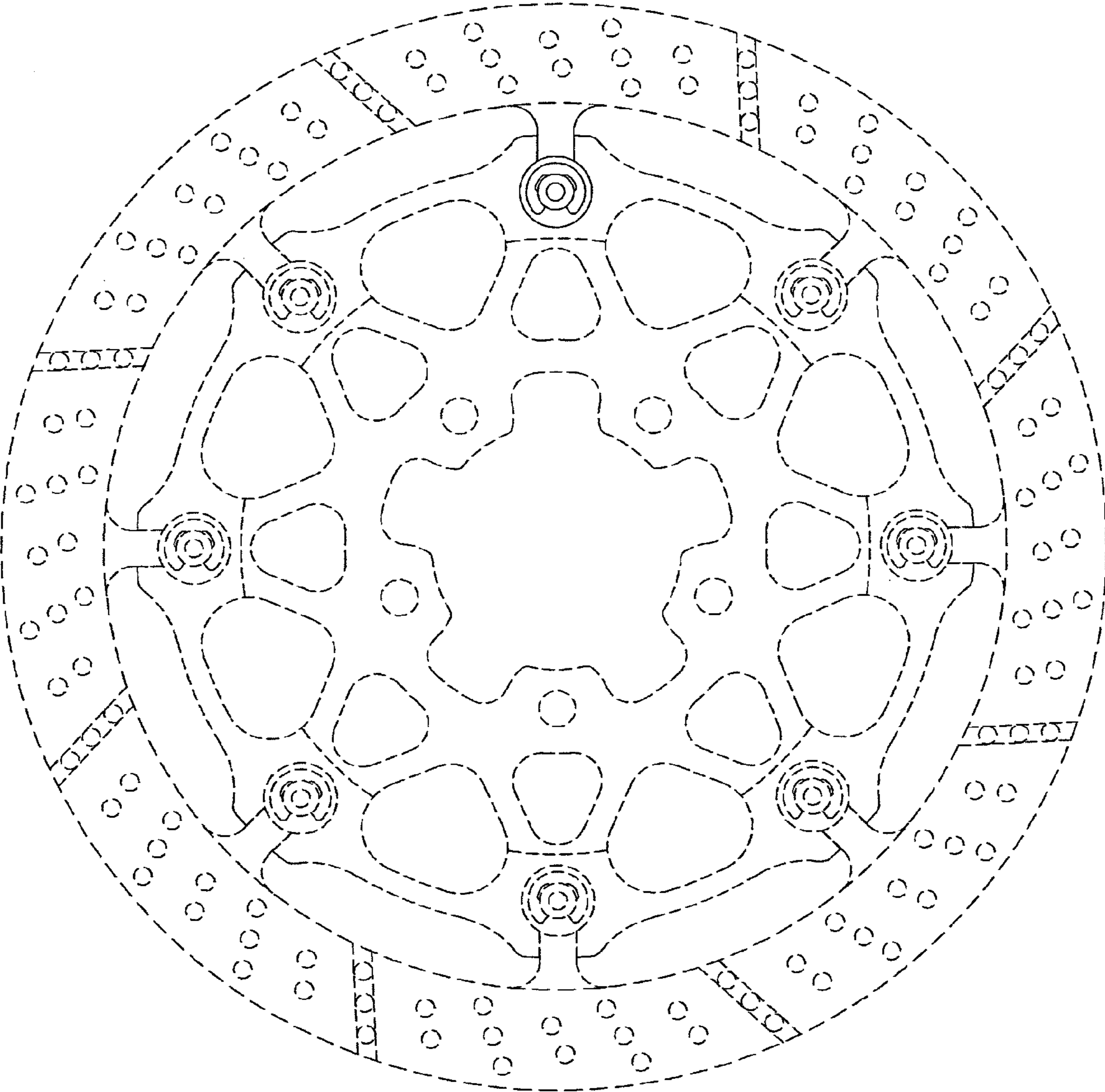

FIG. 5



FIG. 6



FIG. 7

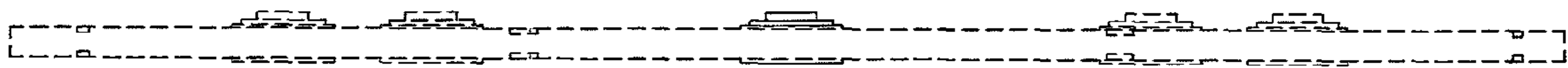



FIG. 8

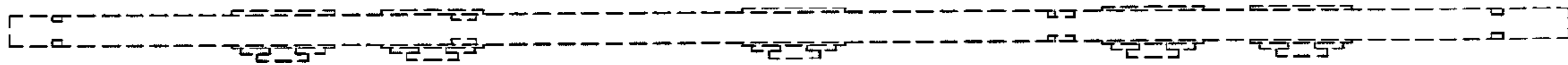

FIG.9

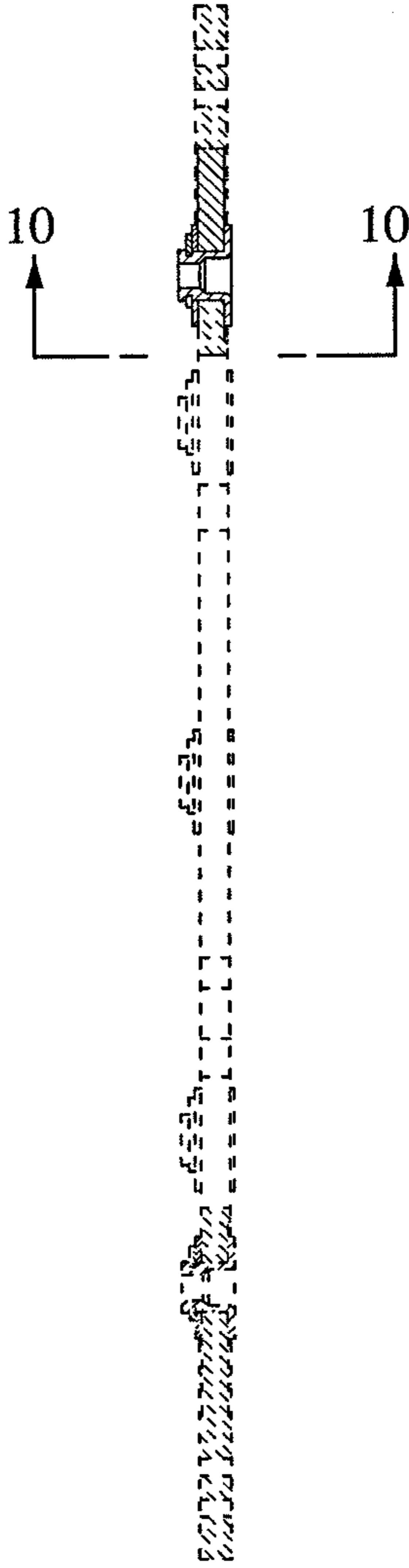

FIG.10

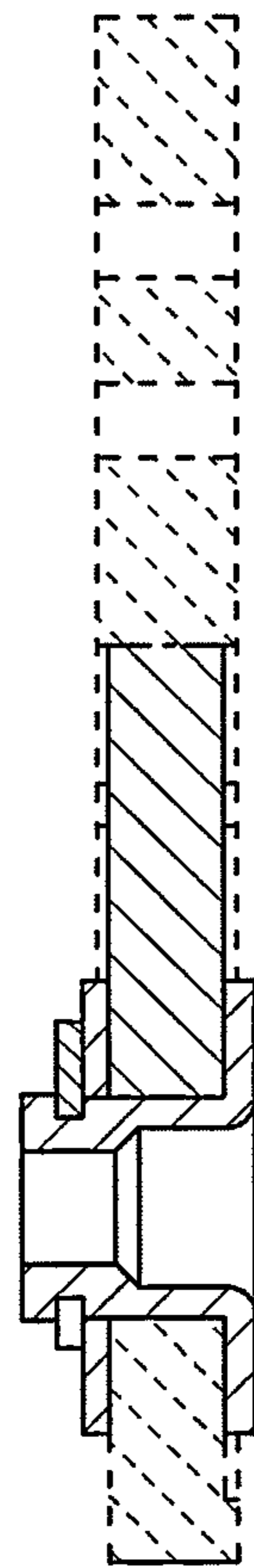

FIG. 11

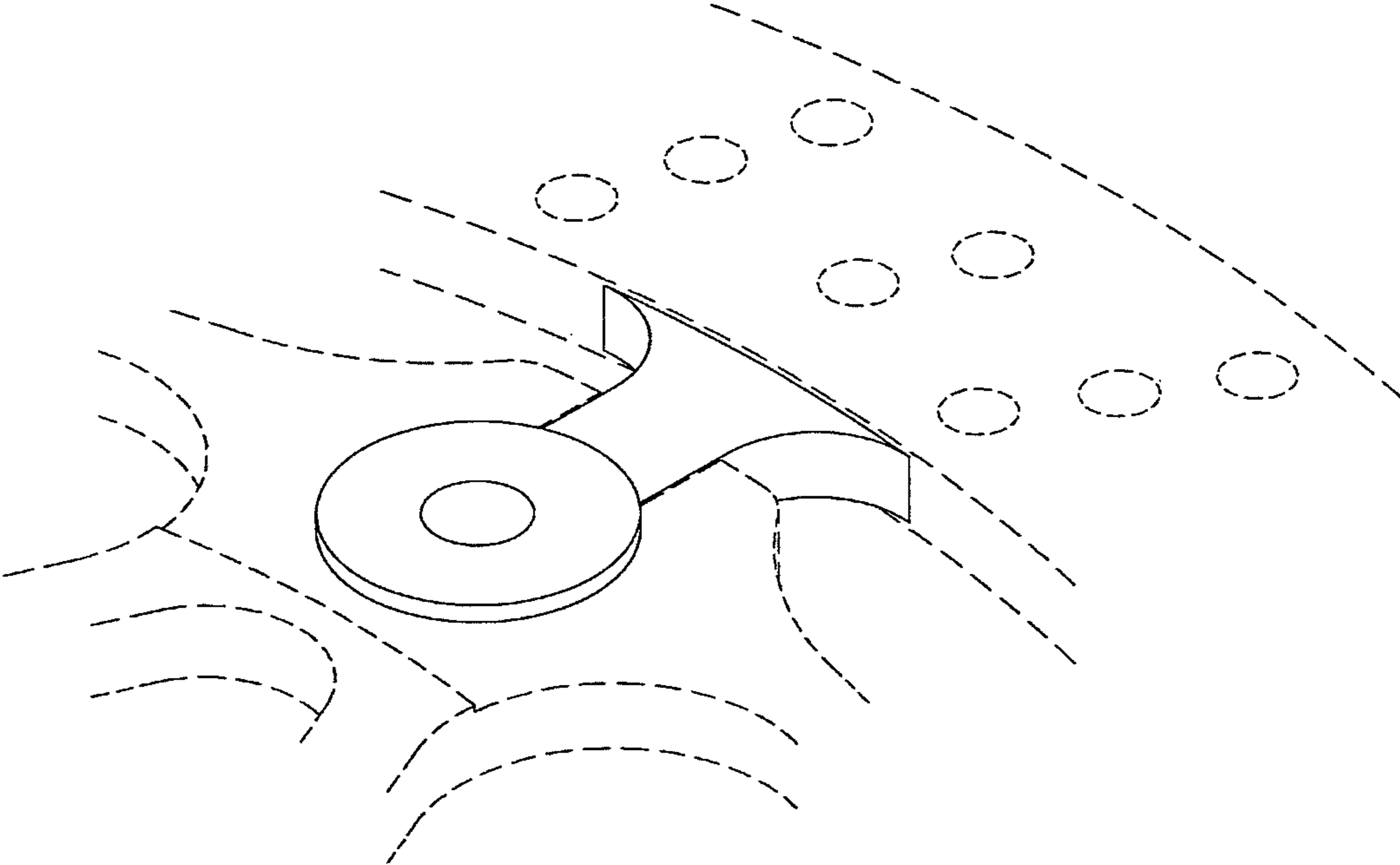

FIG. 12

