



US00D693248S

(12) **United States Design Patent**
Anderssen et al.

(10) **Patent No.:** **US D693,248 S**

(45) **Date of Patent:** **** Nov. 12, 2013**

(54) **LOCATION TRACKING DEVICE**

600/443, 453, 459, 465, 479, 500, 502, 595,
600/485, 481, 483

(71) Applicant: **Evado Filip Holding Ltd.**, London (GB)

See application file for complete search history.

(72) Inventors: **Torbjørn Anderssen**, Oslo (NO); **Sten Kirkbak**, Trondheim (NO); **Pål Selnaes**, Morrisville, NC (US); **William Herbert Darden, IV**, Cary, NC (US); **Espen Voll**, Oslo (NO)

(56) **References Cited**

U.S. PATENT DOCUMENTS

5,835,013	A	*	11/1998	Duterte	340/539.23
D416,502	S	*	11/1999	Autry et al.	D10/65
D474,414	S	*	5/2003	Ikeda et al.	D10/78
D488,731	S	*	4/2004	Barr	D10/65
D524,665	S	*	7/2006	Taisto	D10/65
D549,116	S	*	8/2007	Rhine et al.	D10/65
D614,979	S	*	5/2010	McNames et al.	D10/65
D655,215	S	*	3/2012	Daniel	D10/65
D659,037	S	*	5/2012	Madsen et al.	D10/65
2011/0192960	A1	*	8/2011	Feng et al.	250/214 R

(73) Assignee: **Evado Filip Holding Ltd.**, London (GB)

(**) Term: **14 Years**

* cited by examiner

(21) Appl. No.: **29/441,424**

(22) Filed: **Jan. 4, 2013**

Primary Examiner — Antoine D Davis

(51) **LOC (9) Cl.** **10-04**

(74) *Attorney, Agent, or Firm* — Coats & Bennett, P.L.L.C.

(52) **U.S. Cl.**
USPC **D10/65; D10/70**

(58) **Field of Classification Search**

USPC D10/65, 70, 75, 78; D14/138 R, 138 AA, D14/138 AB, 138 AC, 138 AD, 341-347, D14/507-510, 136, 167, 168, 496, 498, 499, D14/500, 125-134, 239, 371, 374-377, 440, D14/450, 448, 336, 342; 343/702; 345/87, 345/104, 133, 156, 168, 173, 901-905, 345/165; 348/180, 184, 315, 739, 836, 838, 348/325; 364/444, 499; 701/408-418, 431, 701/432, 537; 312/7.2; 341/12; 720/605, 720/669, 600, 655; 369/99, 197; 455/344, 455/347, 575.1; 250/221, 338.3, 340, 239, 250/342, 341, DIG. 1, 353; 307/116, 117; 340/521, 527, 541, 567, 540, 568.2, 340/539.23, 635, 687; 315/159; 324/72.5, 324/556, 133, 149, 503, 543, 555, 66, 72, 324/754, 115, 141, 522; 73/615, 624, 627, 73/644, 514.33, 514.34, 510, 513, 527, 73/530; 356/3.01-5.15; 235/105; 377/5, 377/24.2, 26; 702/155, 160, 176, 78, 79, 702/82, 91-95, 104, 116, 141, 150, 151, 702/154, 127, 131, 182, 183, 189; 600/437,

(57) **CLAIM**

The ornamental design for a location tracking device, as shown and described.

DESCRIPTION

FIG. 1 is a top perspective view of a first embodiment of a location tracking device showing our new design.
FIG. 2 is a bottom perspective view of the location tracking device.
FIG. 3 is a top view of the location tracking device.
FIG. 4 is a bottom view of the location tracking device.
FIG. 5 is a side view of the first side of the location tracking device.
FIG. 6 is a side view of the second side of the location tracking device.
FIG. 7 is a side view of the third side of the location tracking device.
FIG. 8 is a side view of the fourth side of the location tracking device.
FIG. 9 is a top perspective view of a second embodiment of a location tracking device showing our new design.

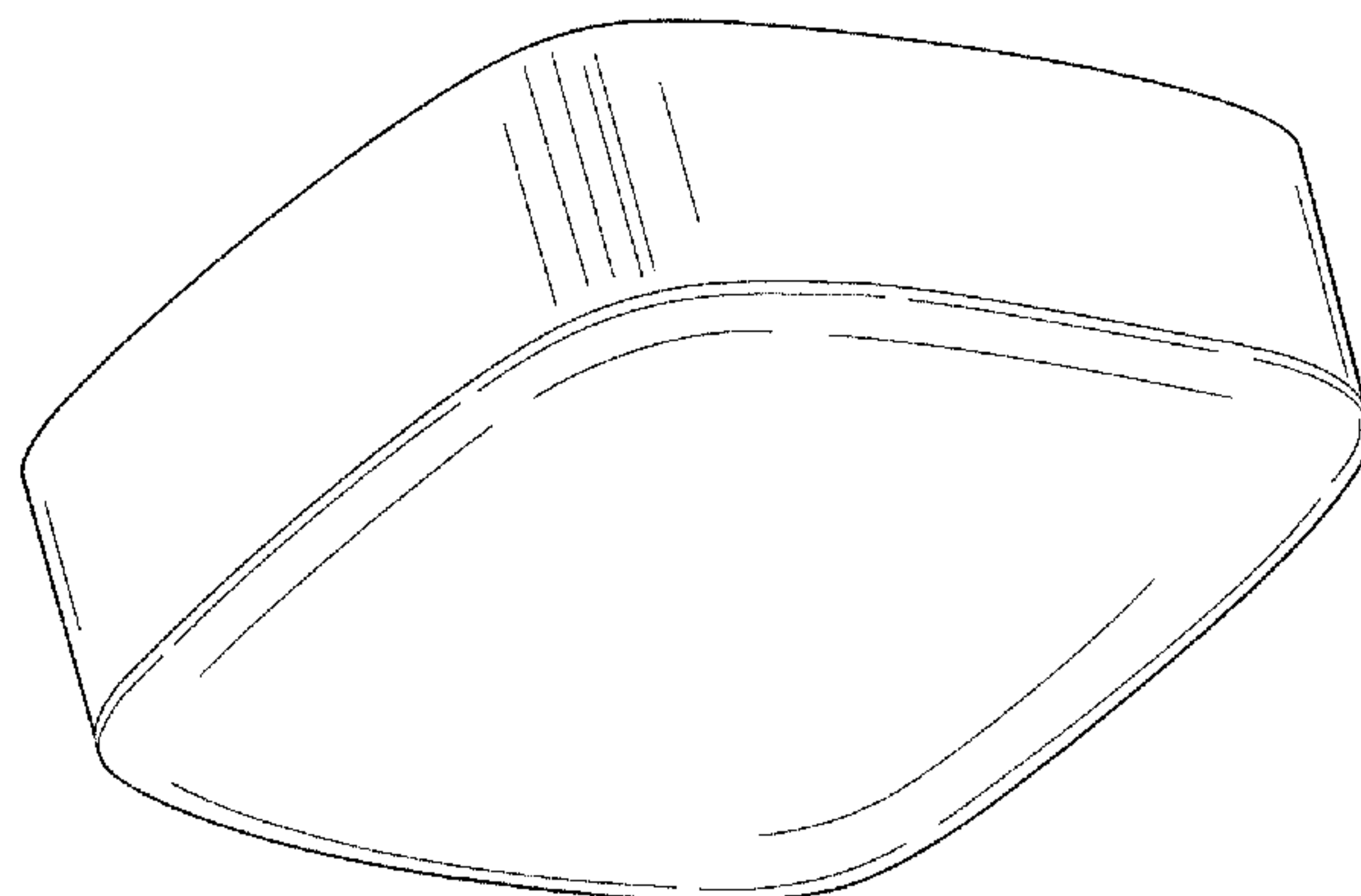
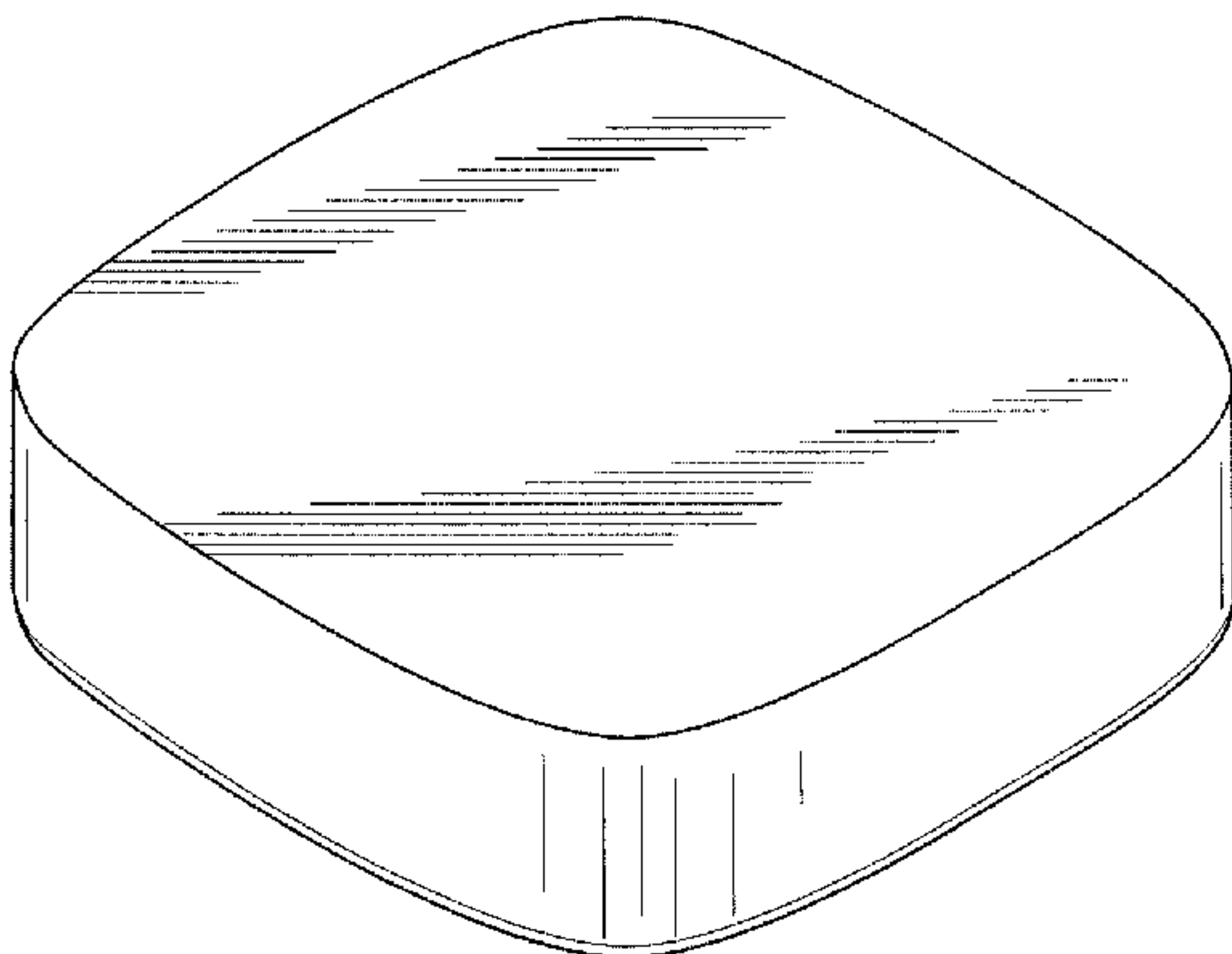

FIG. **10** is a bottom perspective view of the location tracking device.

FIG. **11** is a top view of the location tracking device.

FIG. **12** is a bottom view of the location tracking device.

FIG. **13** is a side view of the first side of the location tracking device.

FIG. **14** is a side view of the second side of the location tracking device.

FIG. **15** is a side view of the third side of the location tracking device; and,

FIG. **16** is a side view of the fourth side of the location tracking device.

Throughout the Figures, aspects shown in broken lines are not considered a portion of the claimed ornamental design.

1 Claim, 12 Drawing Sheets

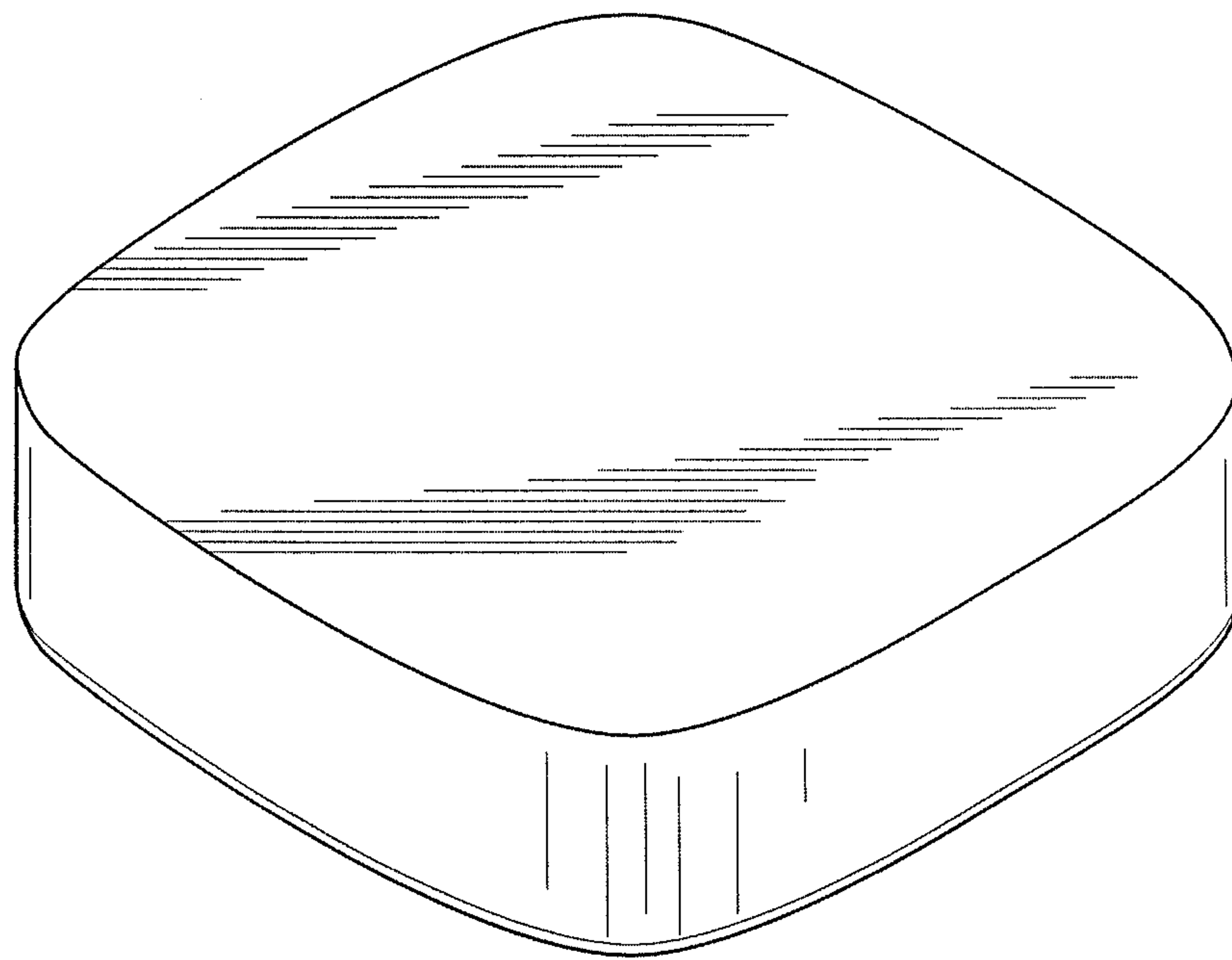

FIG. 1

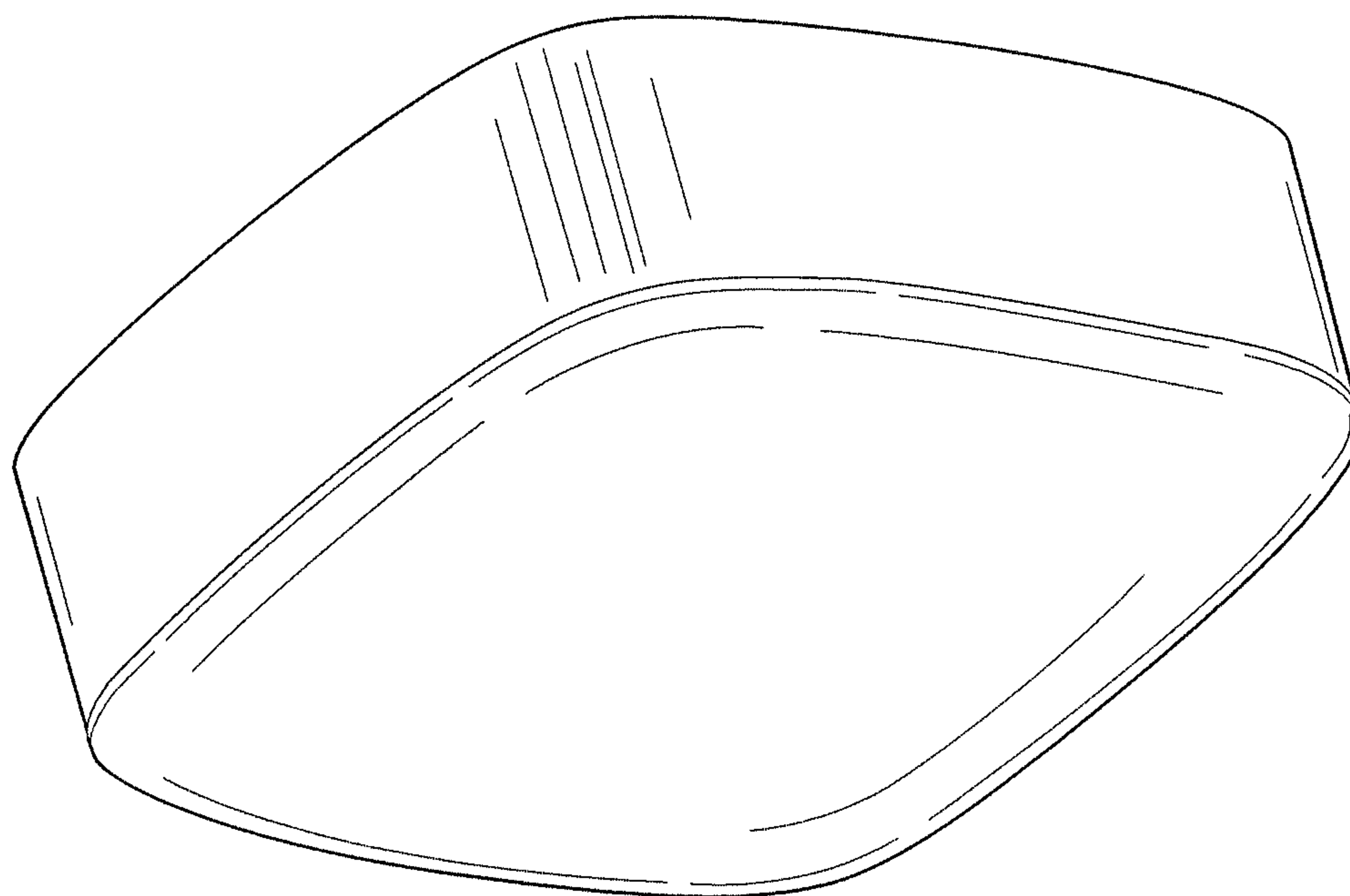

FIG. 2

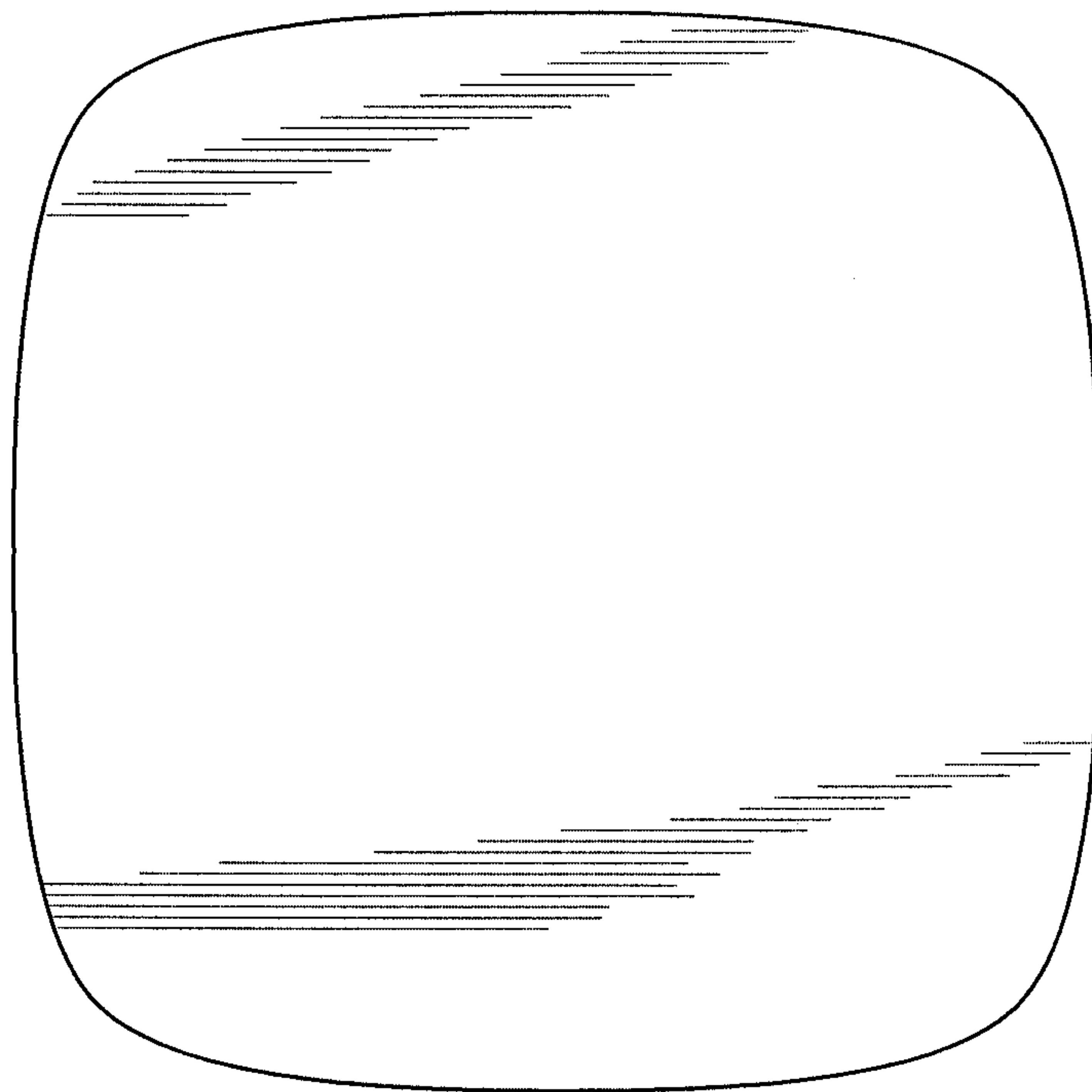

FIG. 3

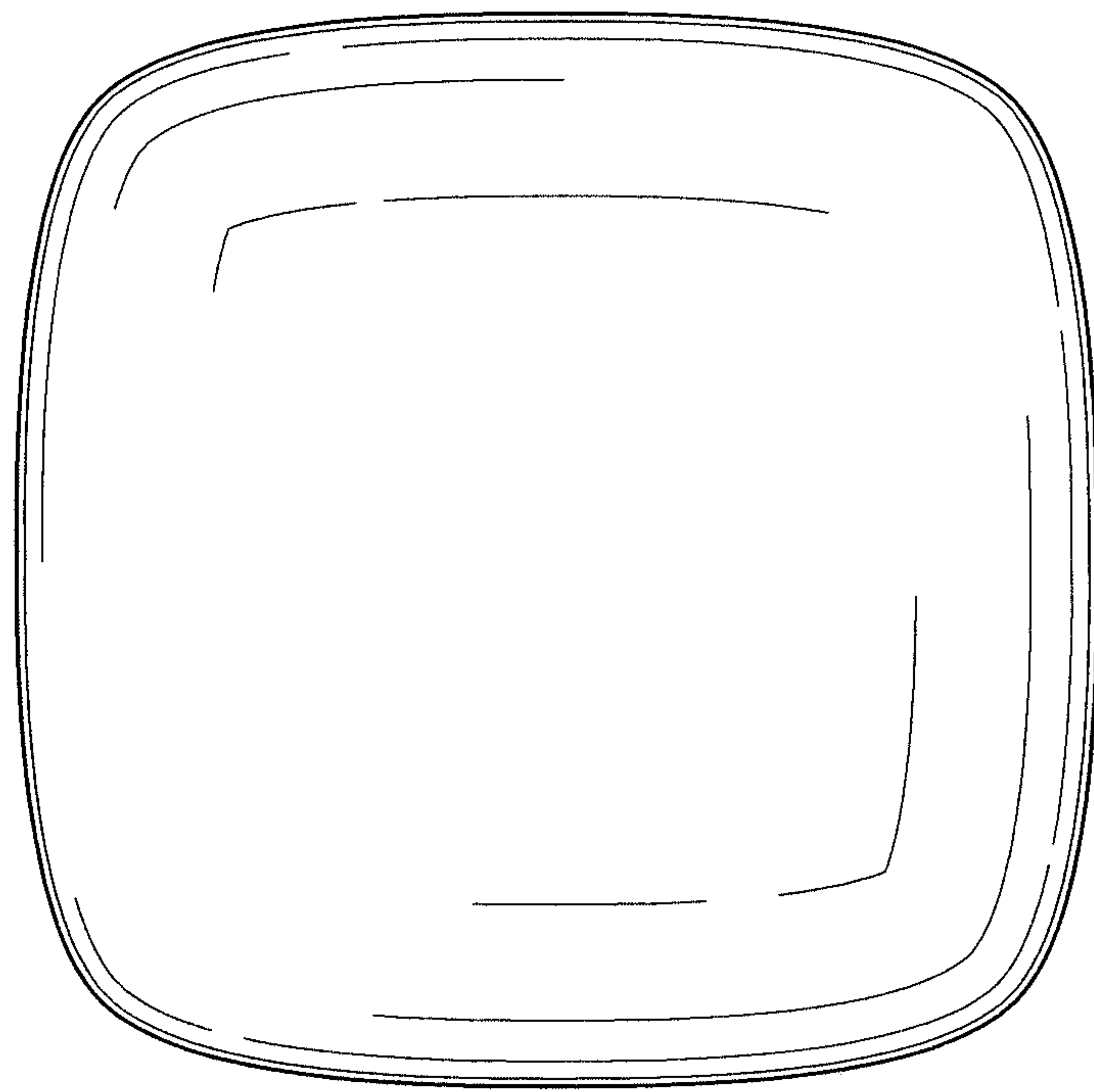

FIG. 4

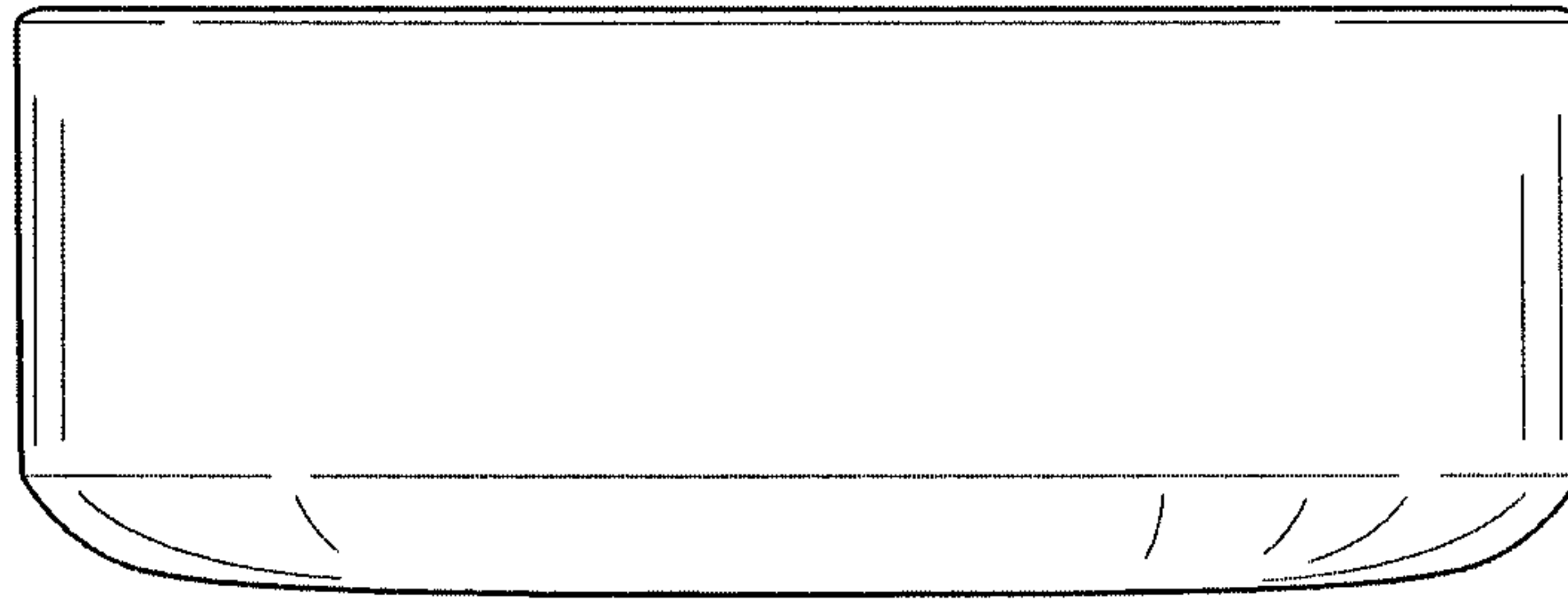

FIG. 5

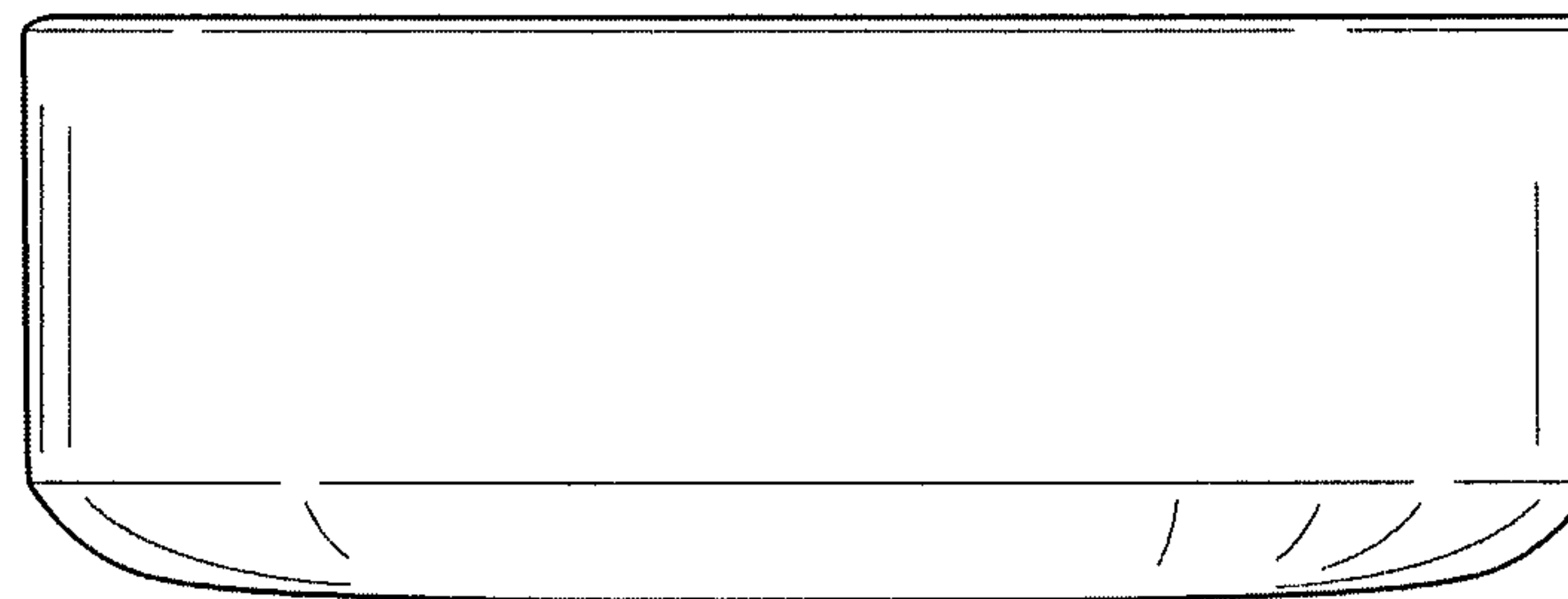

FIG. 6

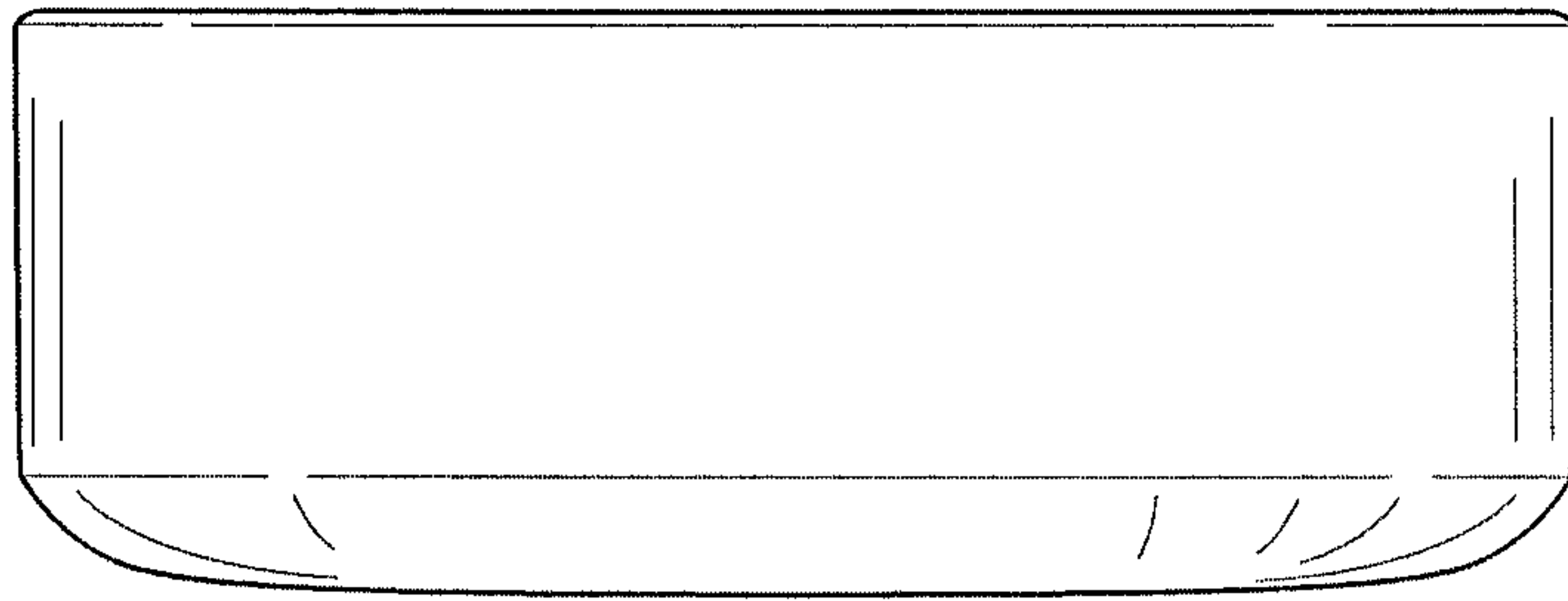

FIG. 7

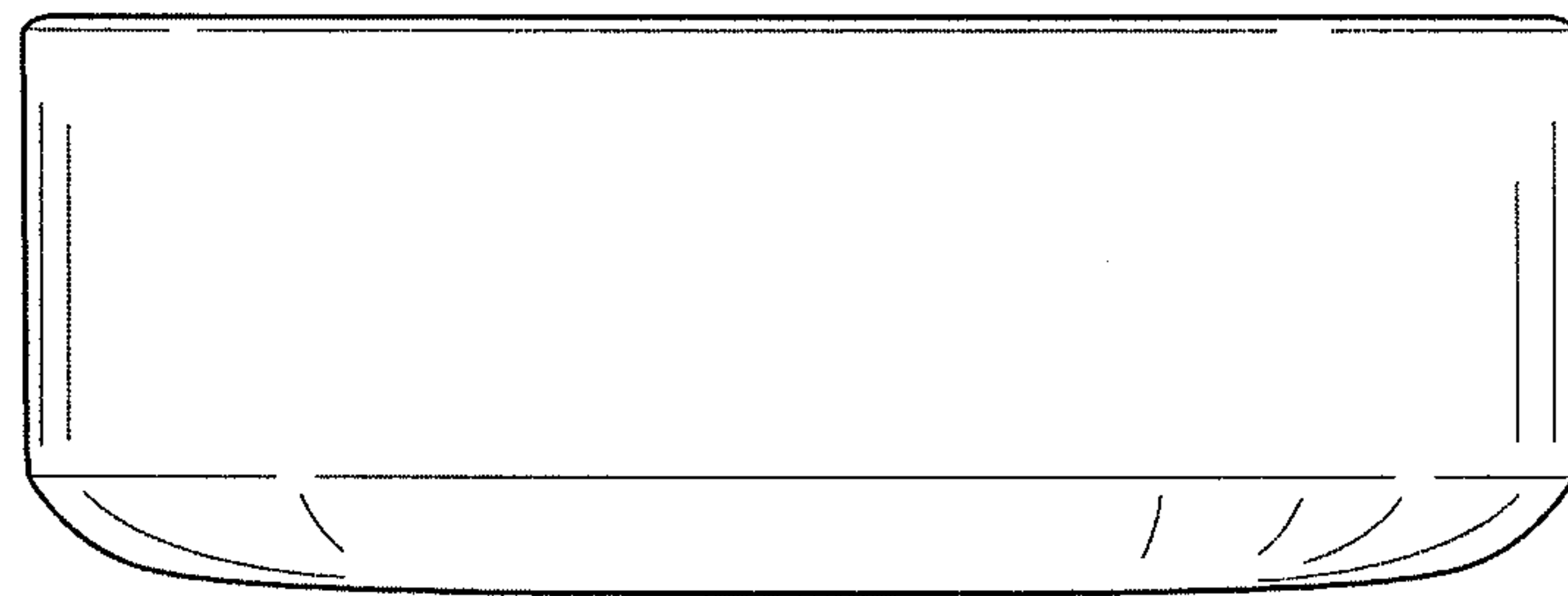

FIG. 8

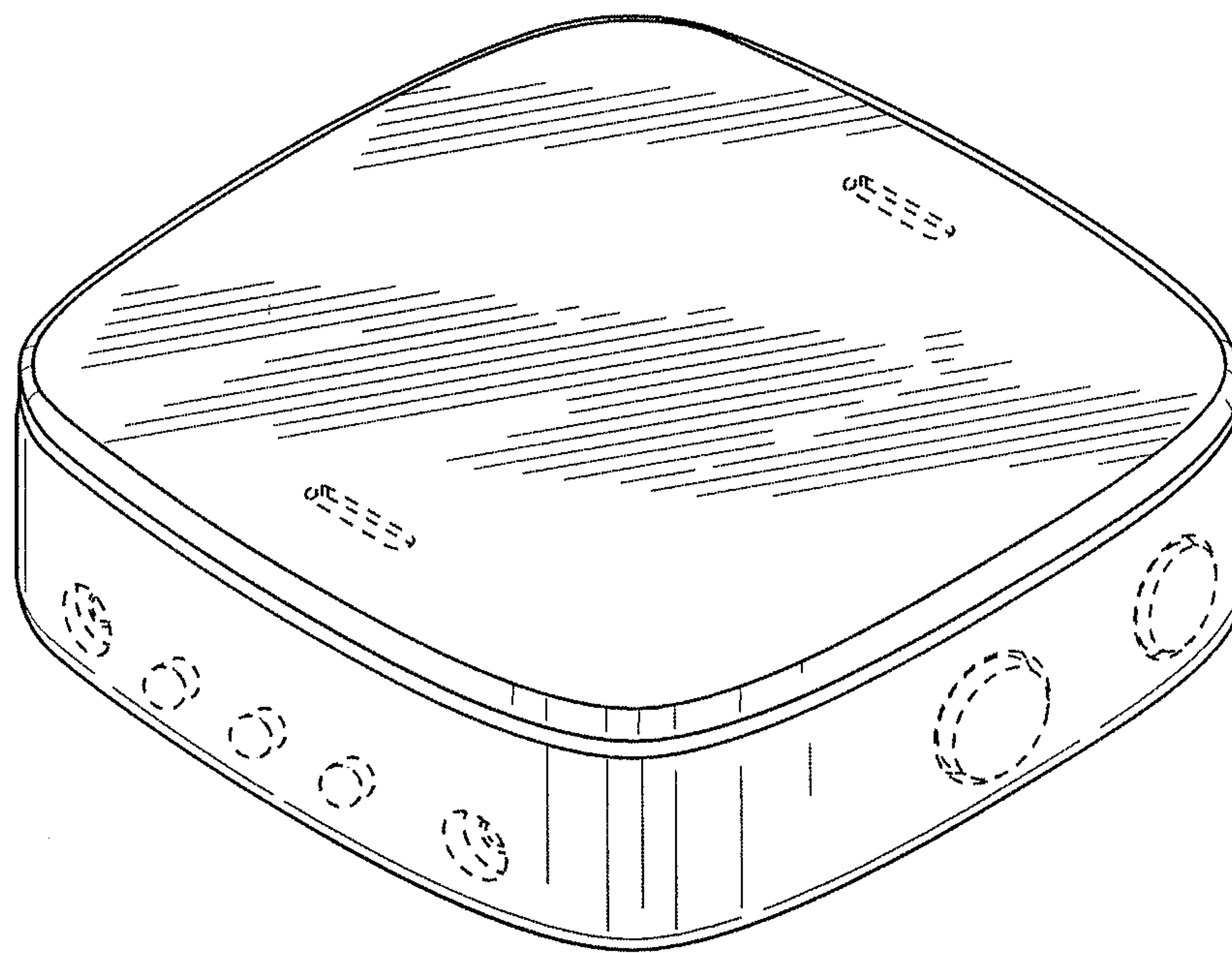

FIG. 9

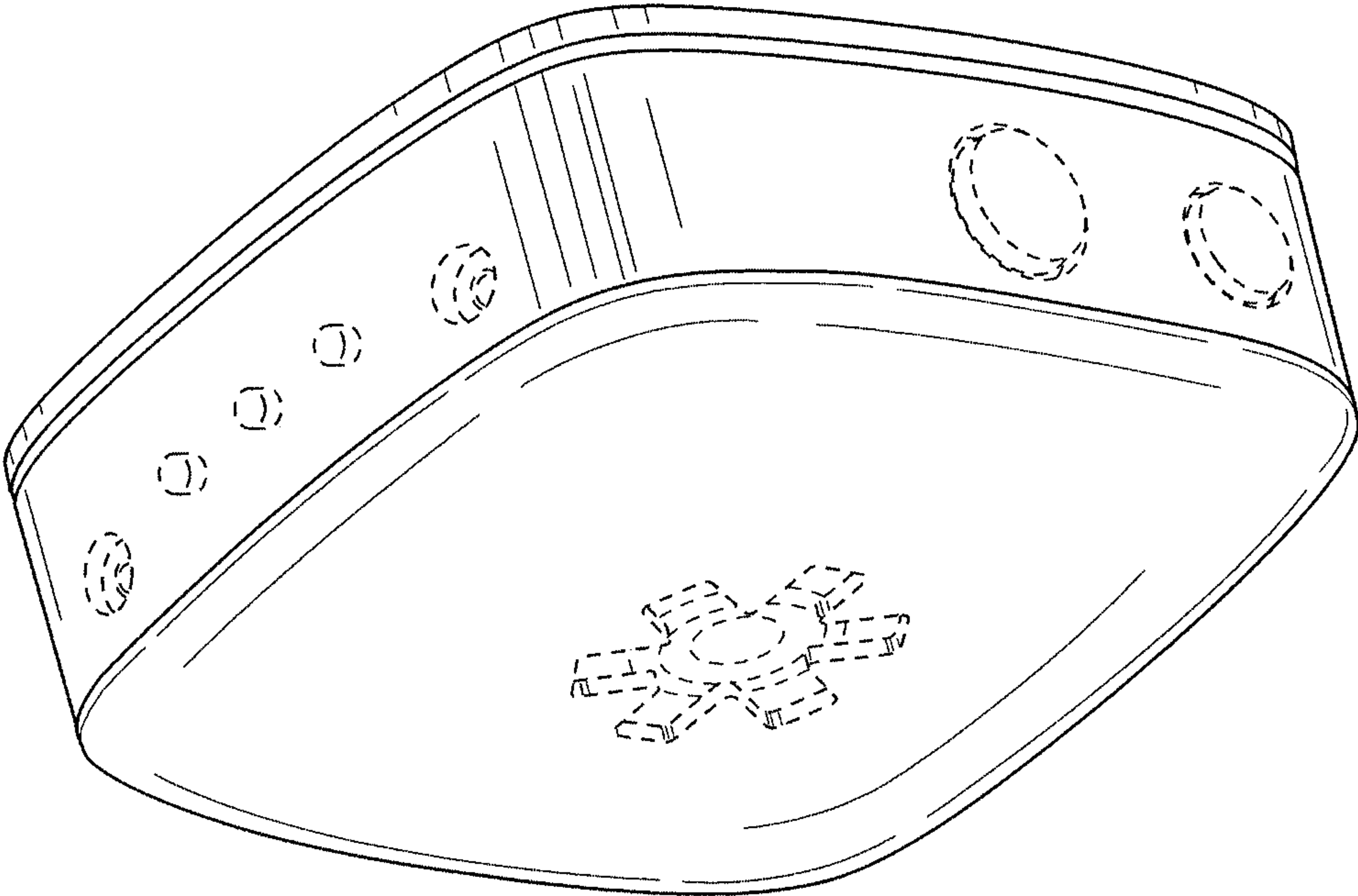

FIG. 10

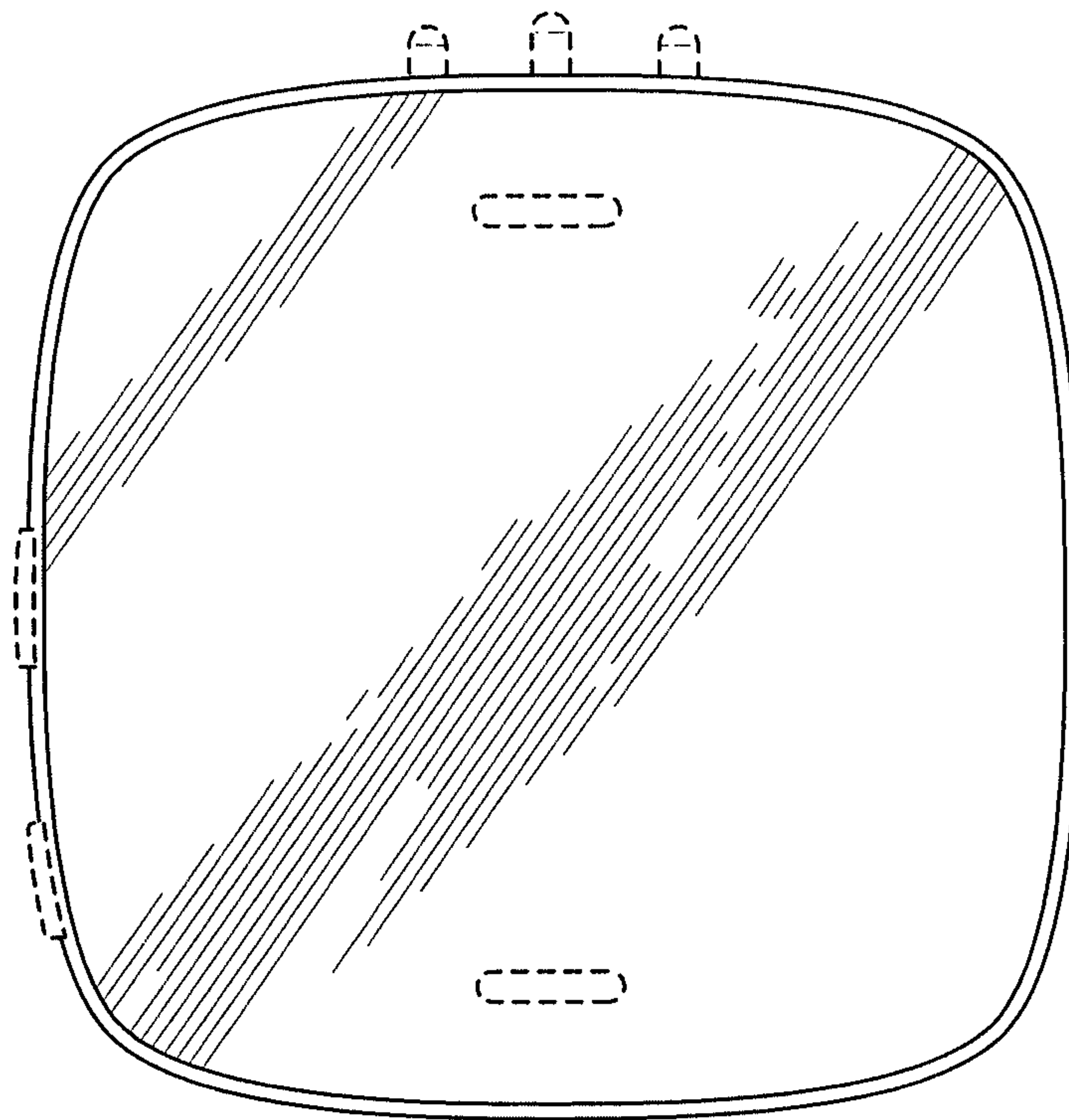

FIG. 11

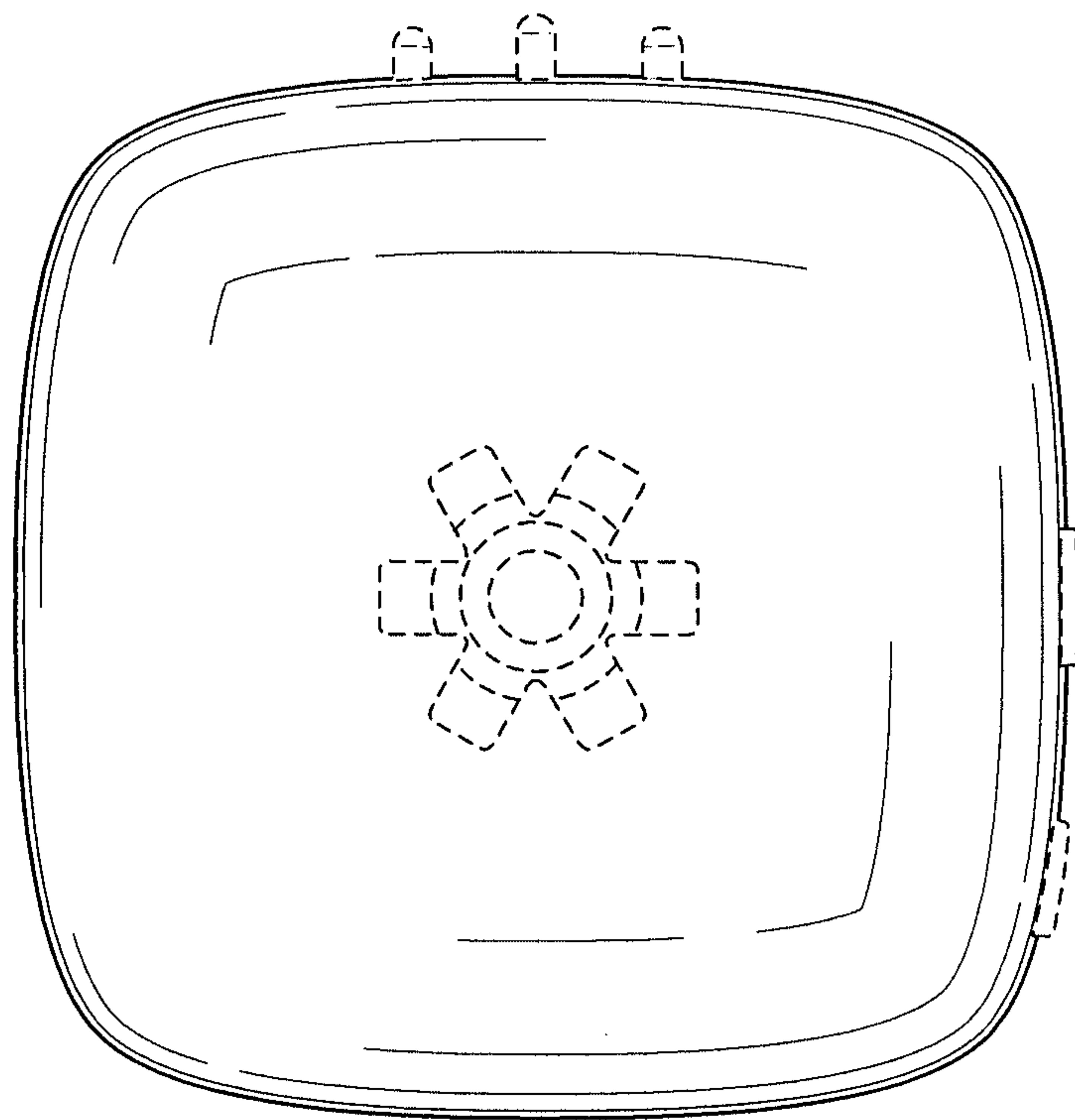

FIG. 12

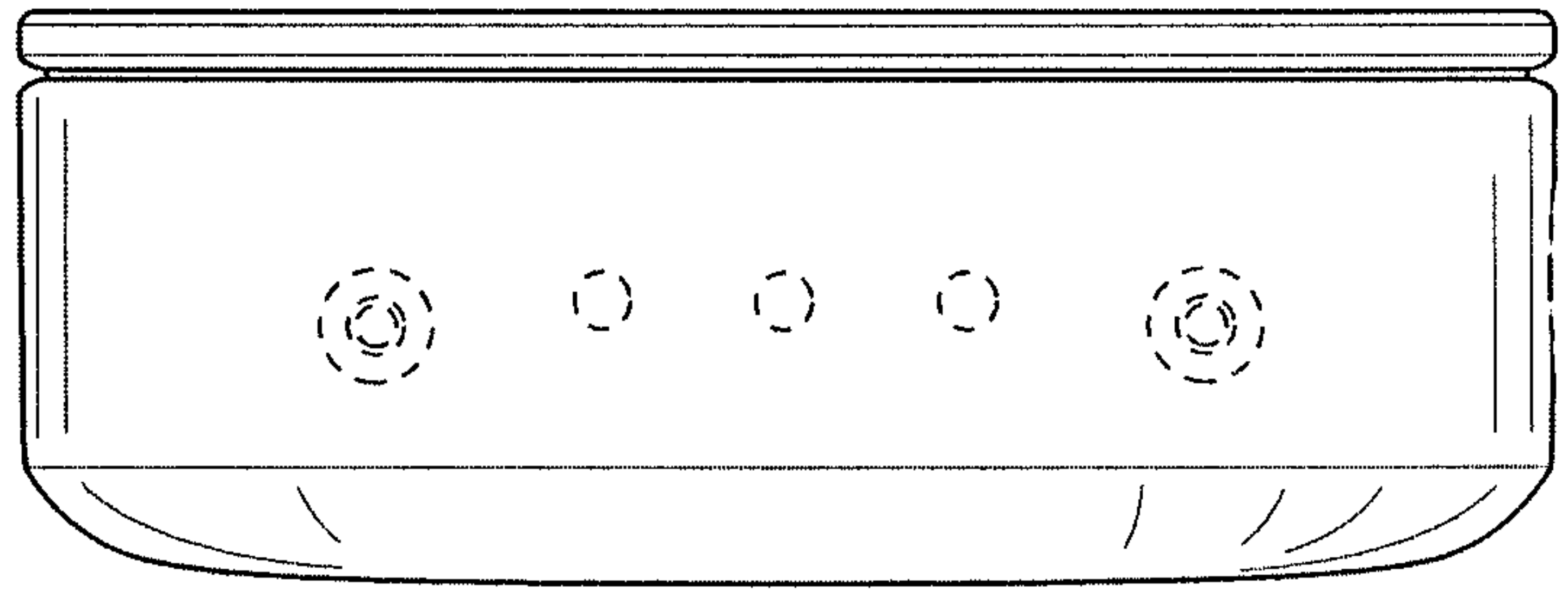

FIG. 13

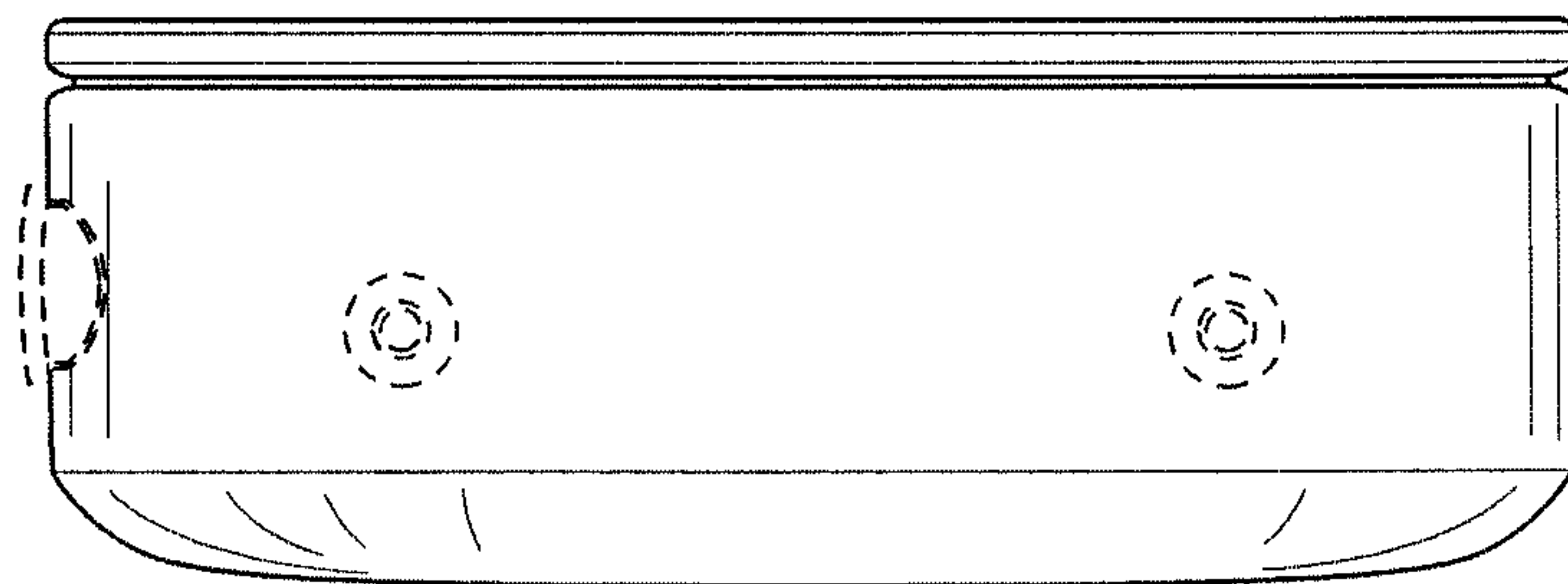

FIG. 14

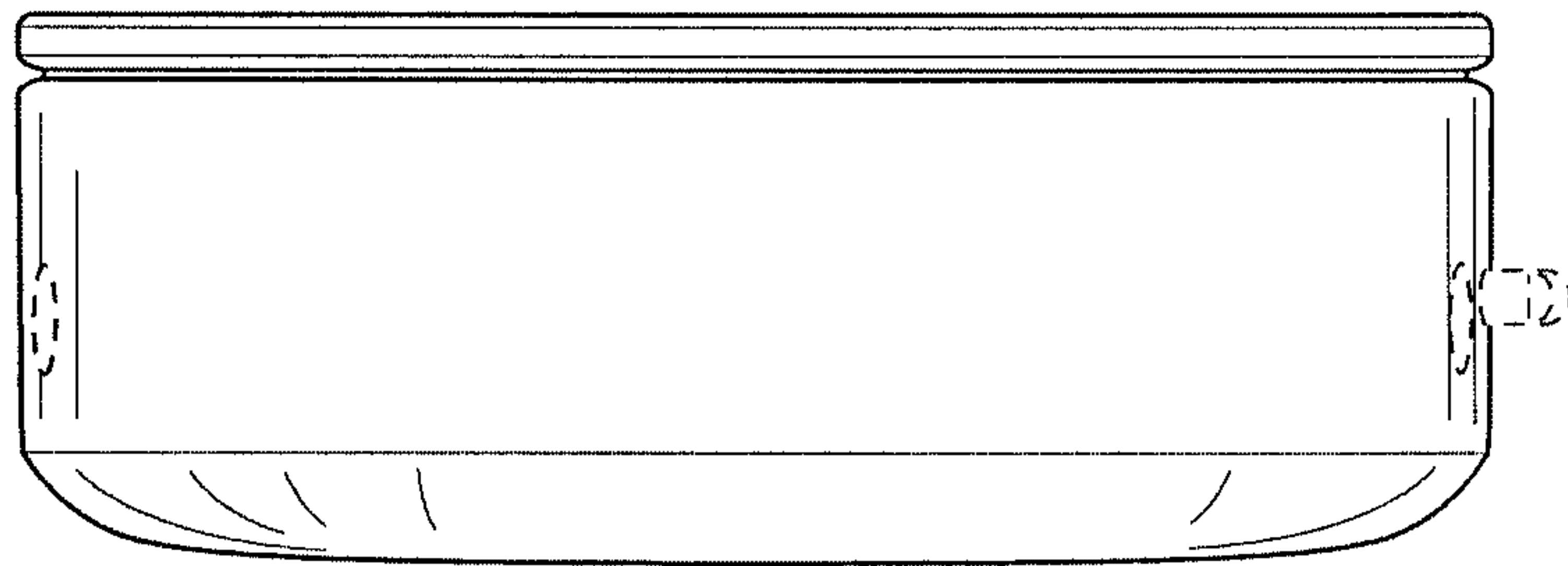

FIG. 15

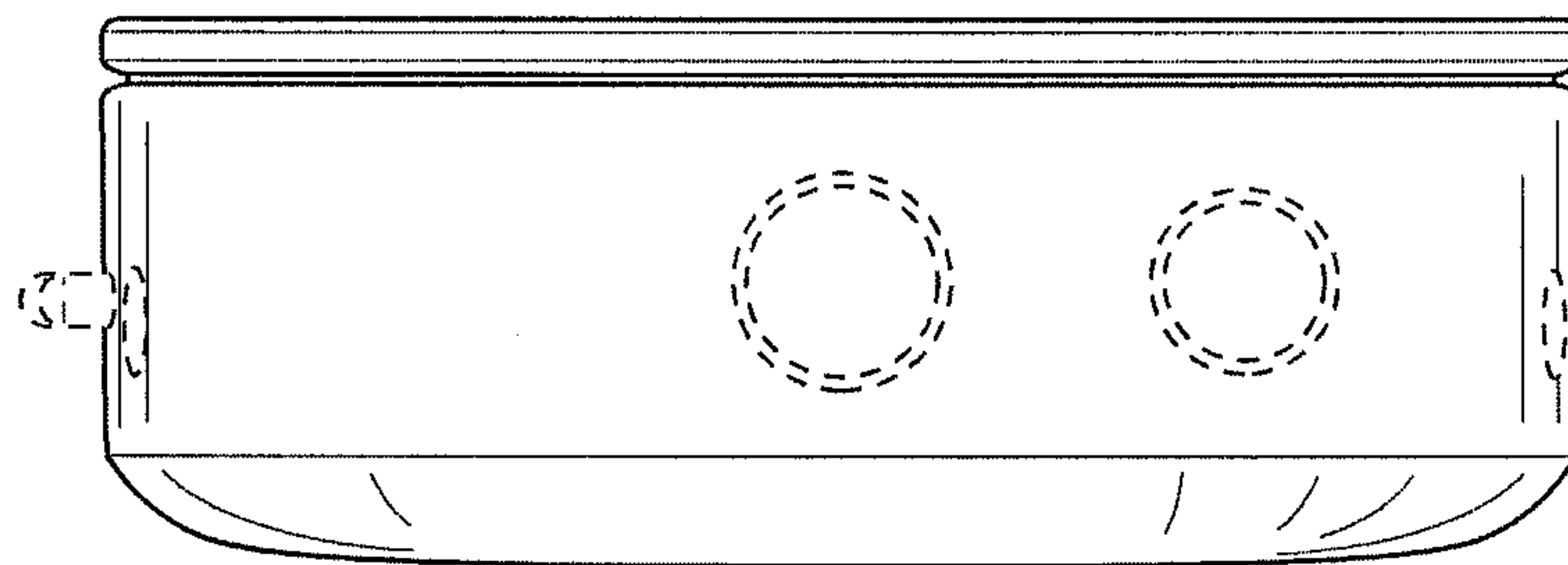

FIG. 16