



US00D693197S

(12) **United States Design Patent**
Hutchfield et al.

(10) **Patent No.:** **US D693,197 S**

(45) **Date of Patent:** **** Nov. 12, 2013**

(54) **HAND OPERATED CRIMPING TOOL**

(75) Inventors: **John Hutchfield**, Sudbury (GB); **Niklas Jonasson**, Mora (SE); **Lars-Olov Persson**, Alvdalen (SE)

(73) Assignee: **Pressmaster AB**, Alvdalen (SE)

(**) Term: **14 Years**

(21) Appl. No.: **29/420,656**

(22) Filed: **May 11, 2012**

(30) **Foreign Application Priority Data**

Feb. 8, 2012 (EM) 001988346-0003

(51) **LOC (9) Cl.** **08-05**

(52) **U.S. Cl.**
USPC **D8/51**

(58) **Field of Classification Search**
USPC D8/60, 51, 52, 54, 59, 32; 72/370.12,
72/316-322, 300, 352, 381; 29/268, 270,
29/750, 751, 753
See application file for complete search history.

(56) **References Cited**

U.S. PATENT DOCUMENTS

D303,917 S * 10/1989 Hatfield D8/51
5,195,353 A * 3/1993 Erbrick et al. 72/409.11
5,992,002 A * 11/1999 Hung 29/566.4
D455,325 S * 4/2002 Steiner D8/51
6,637,060 B2 * 10/2003 Lu 7/107

D504,296 S * 4/2005 Chen D8/52
D506,660 S * 6/2005 Chen D8/52
6,948,234 B1 * 9/2005 Steiner 29/751
D543,429 S * 5/2007 Norin D8/52
D544,323 S * 6/2007 Hutchfield D8/52
D558,014 S * 12/2007 Hutchfield D8/52

* cited by examiner

Primary Examiner — Sheryl Lane

(74) *Attorney, Agent, or Firm* — Dickstein Shapiro LLP

(57) **CLAIM**

The ornamental design for a hand operated crimping tool, as shown and described.

DESCRIPTION

FIG. 1 is a front, left side, and top perspective view of a hand operated crimping tool, showing the new design;
FIG. 2 is a front, right side, and top perspective view thereof;
FIG. 3 is a front view thereof;
FIG. 4 is a rear view thereof;
FIG. 5 is a bottom view thereof;
FIG. 6 is a top view thereof;
FIG. 7 is a left side view thereof;
FIG. 8 is a right side view thereof;
FIG. 9 is a front, left side, and bottom perspective view thereof;
FIG. 10 is a front, right side, and bottom perspective view thereof;
FIG. 11 is an enlarged version of FIG. 5;
FIG. 12 is an enlarged version of FIG. 7; and,
FIG. 13 is an enlarged version of FIG. 8.
The broken lines of the crimping tool form no part of the claimed design.

1 Claim, 9 Drawing Sheets

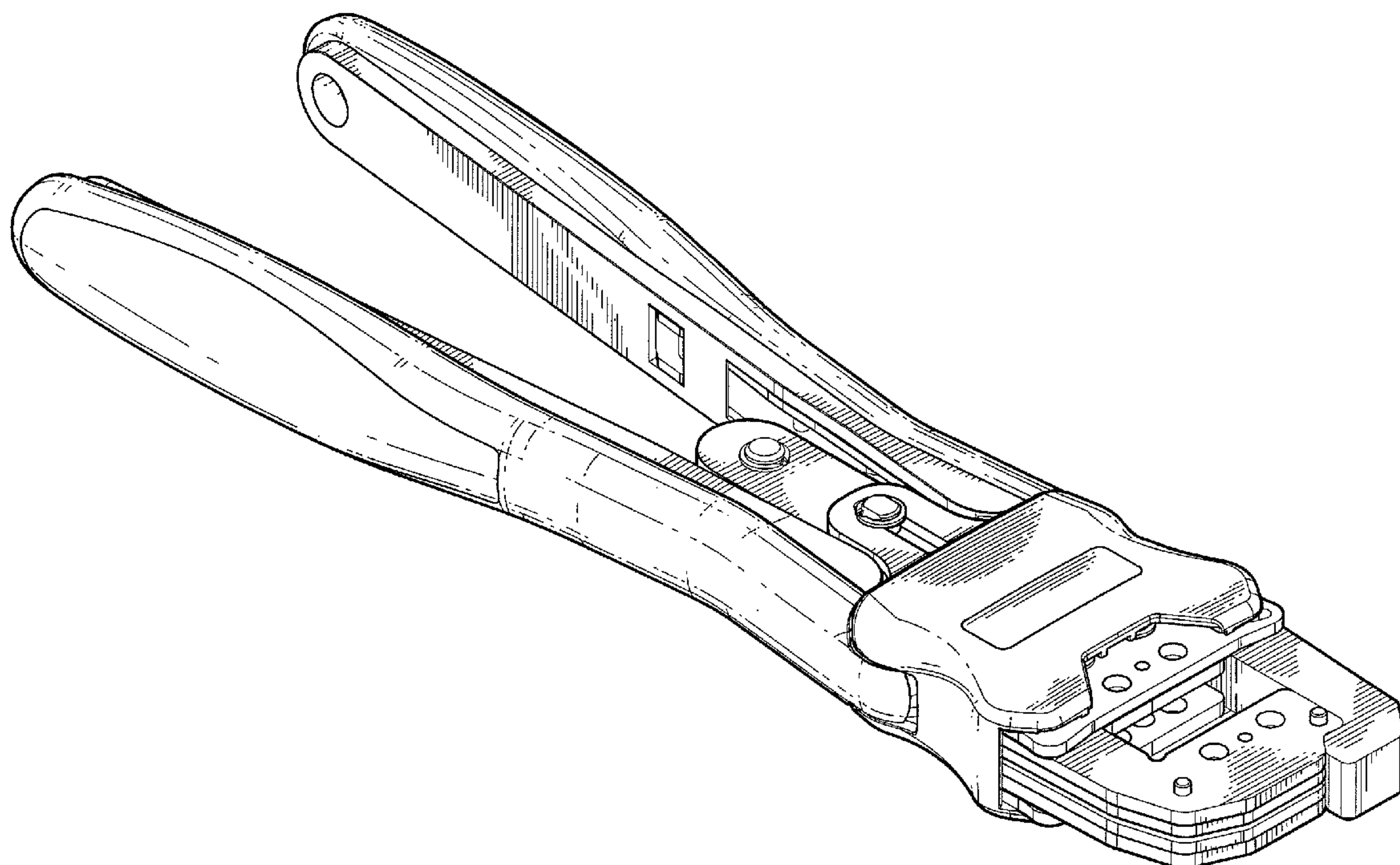

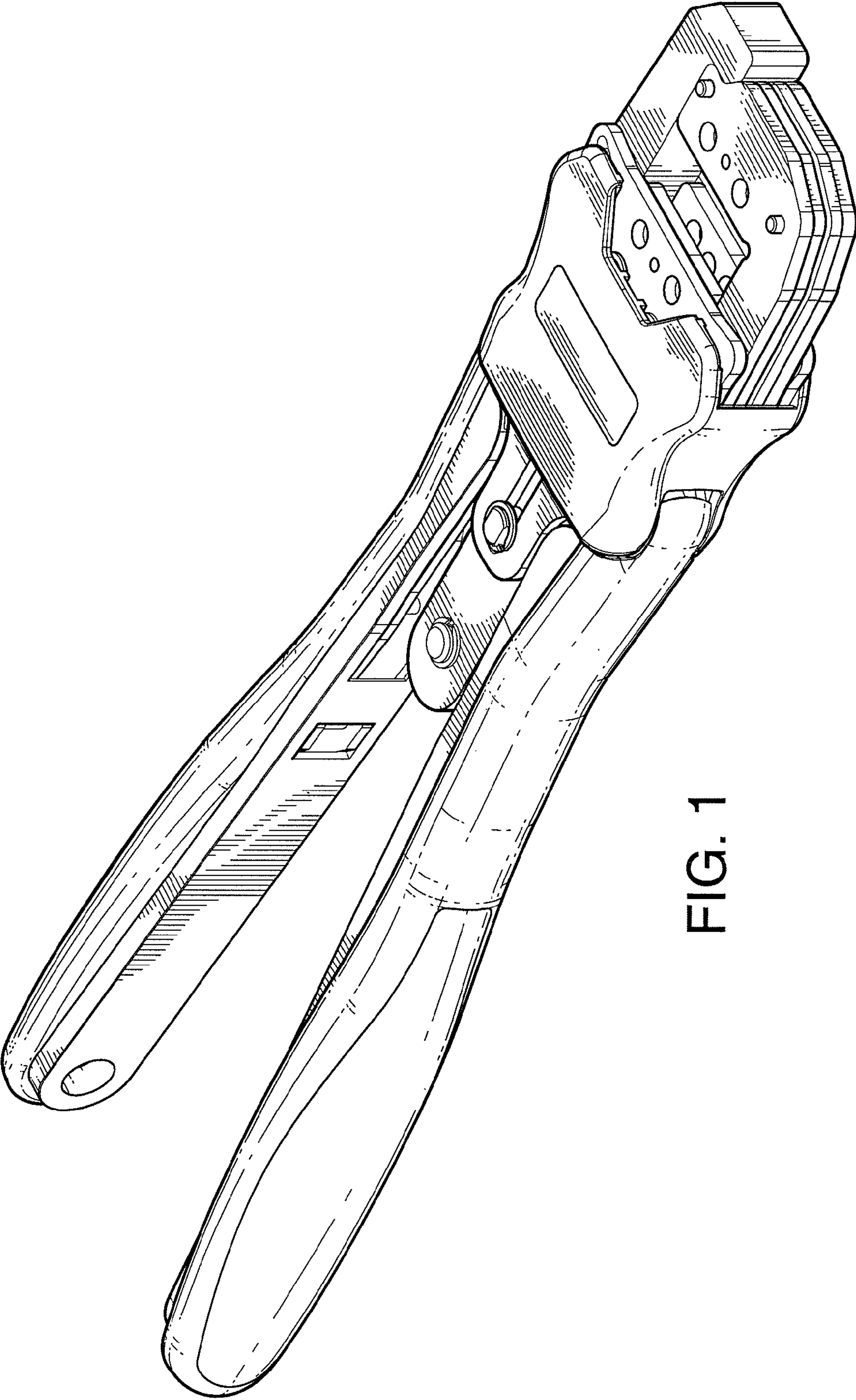

FIG. 1

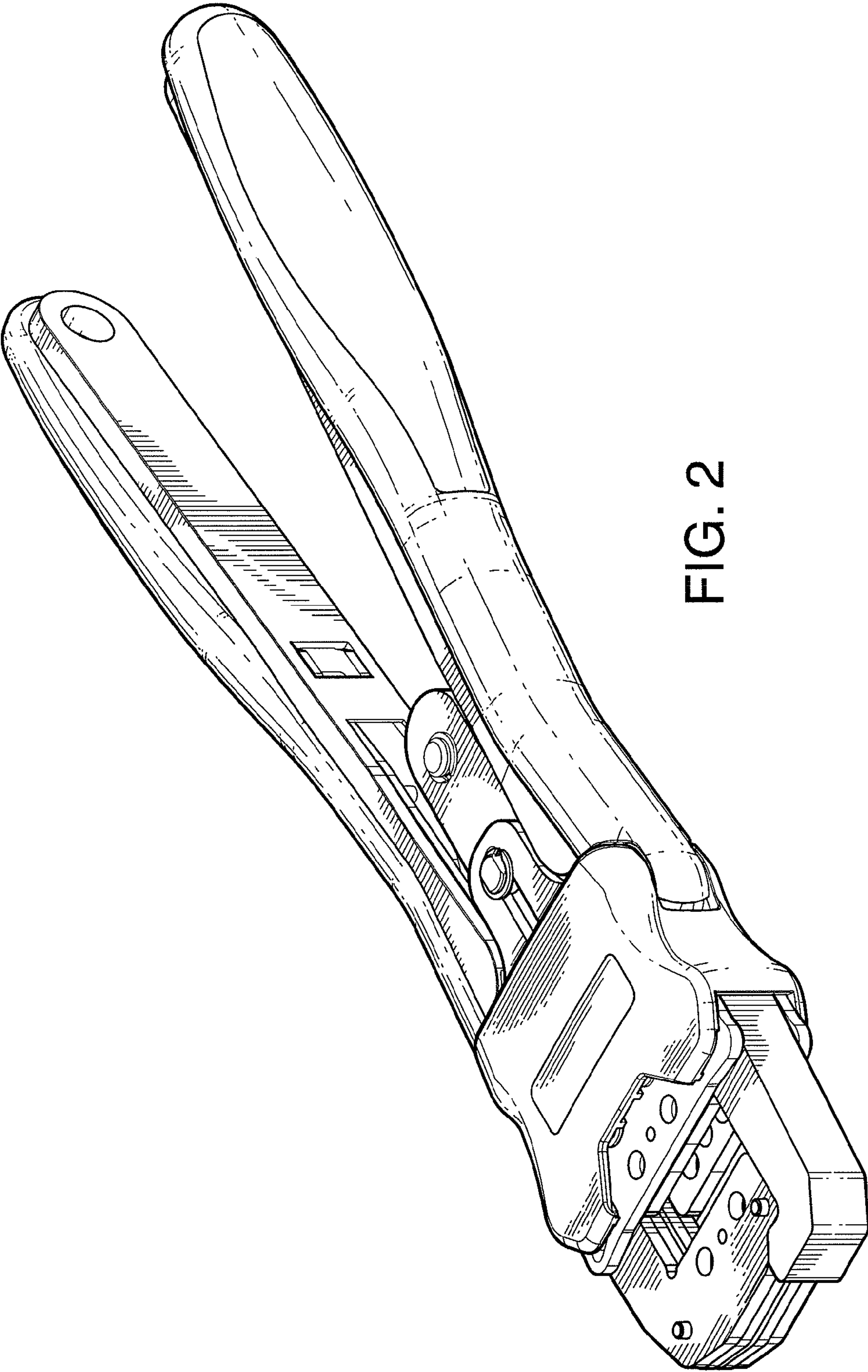

FIG. 2

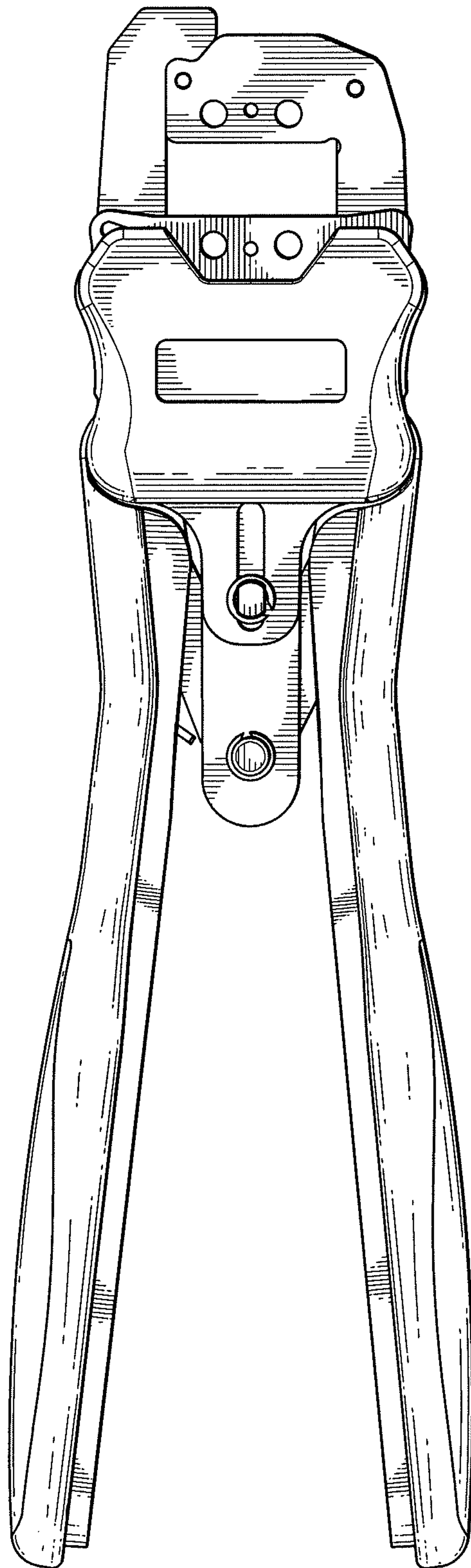

FIG. 3

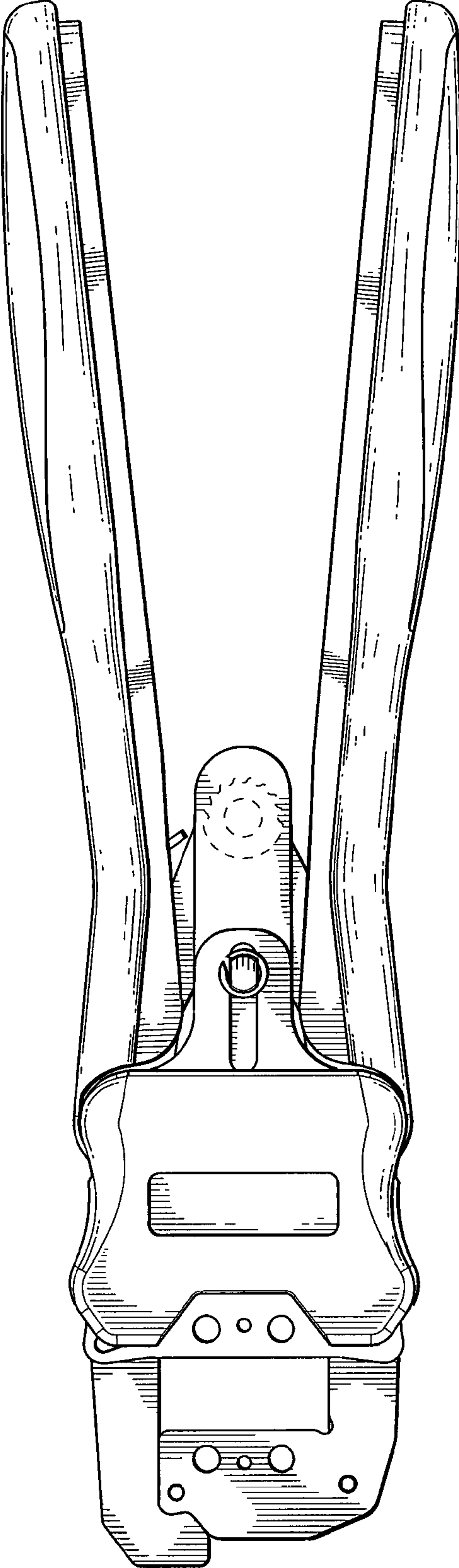

FIG. 4

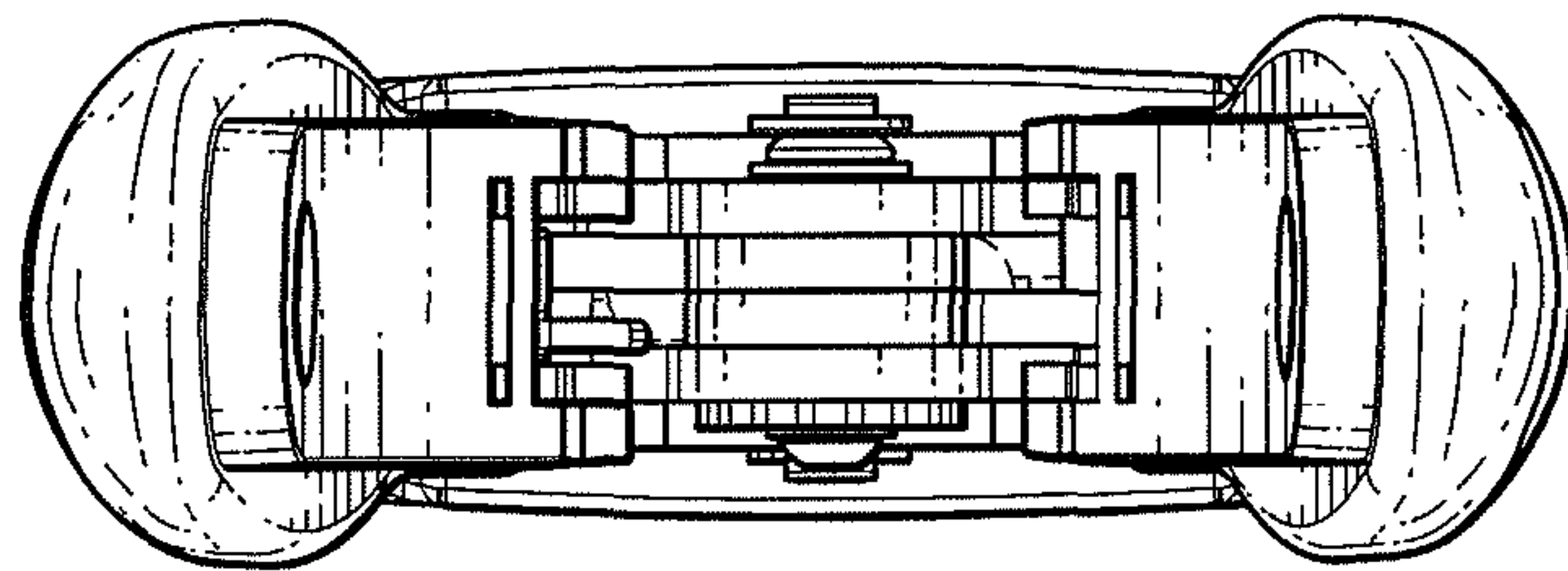

FIG. 5

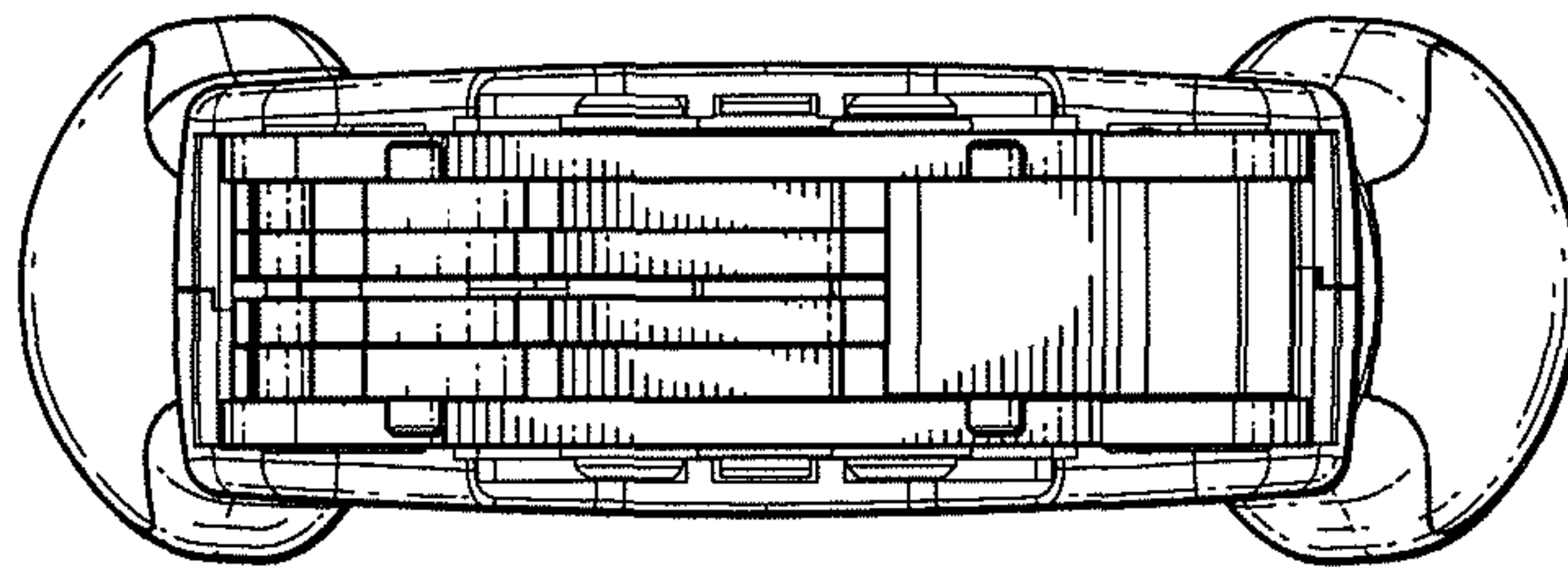

FIG. 6

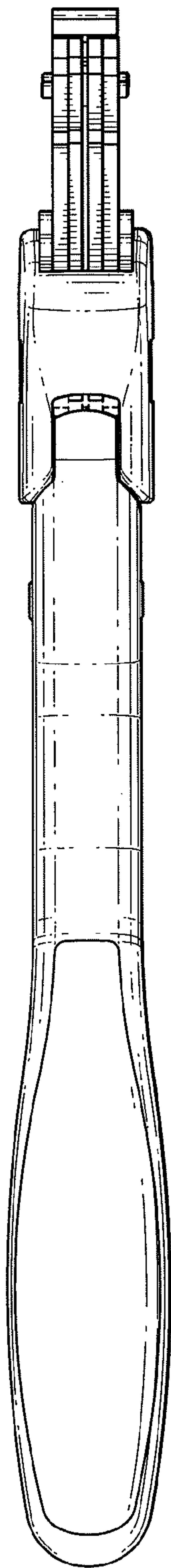

FIG. 7

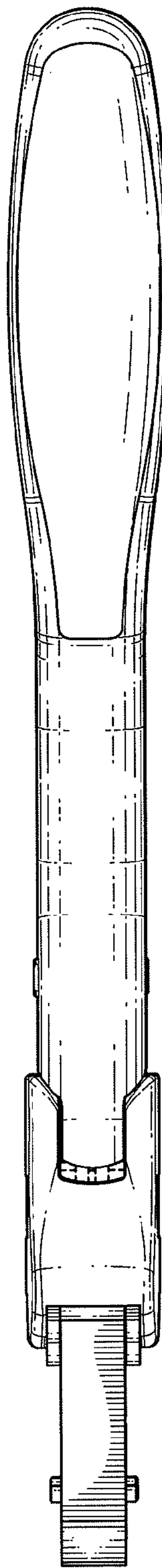

FIG. 8

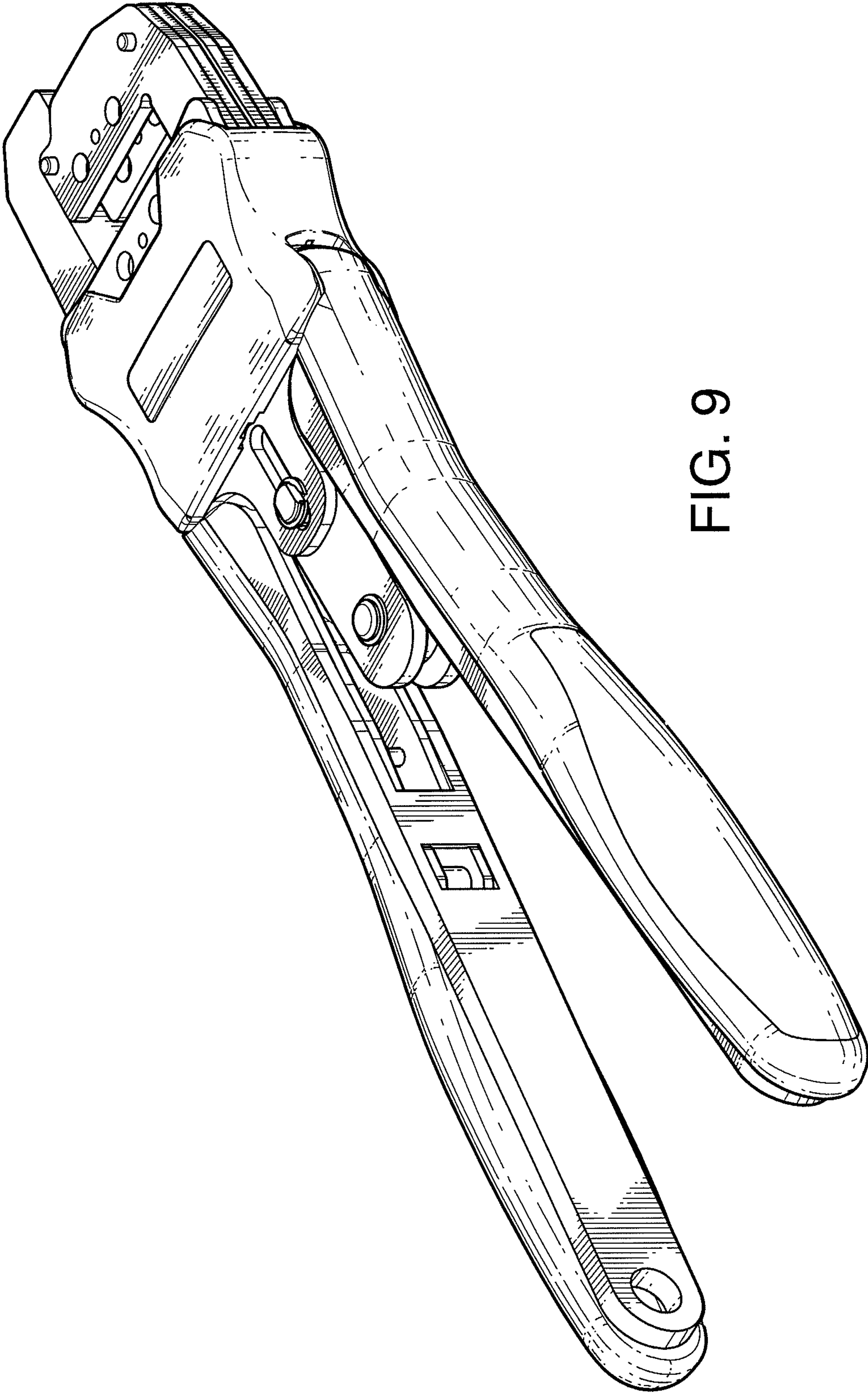

FIG. 9

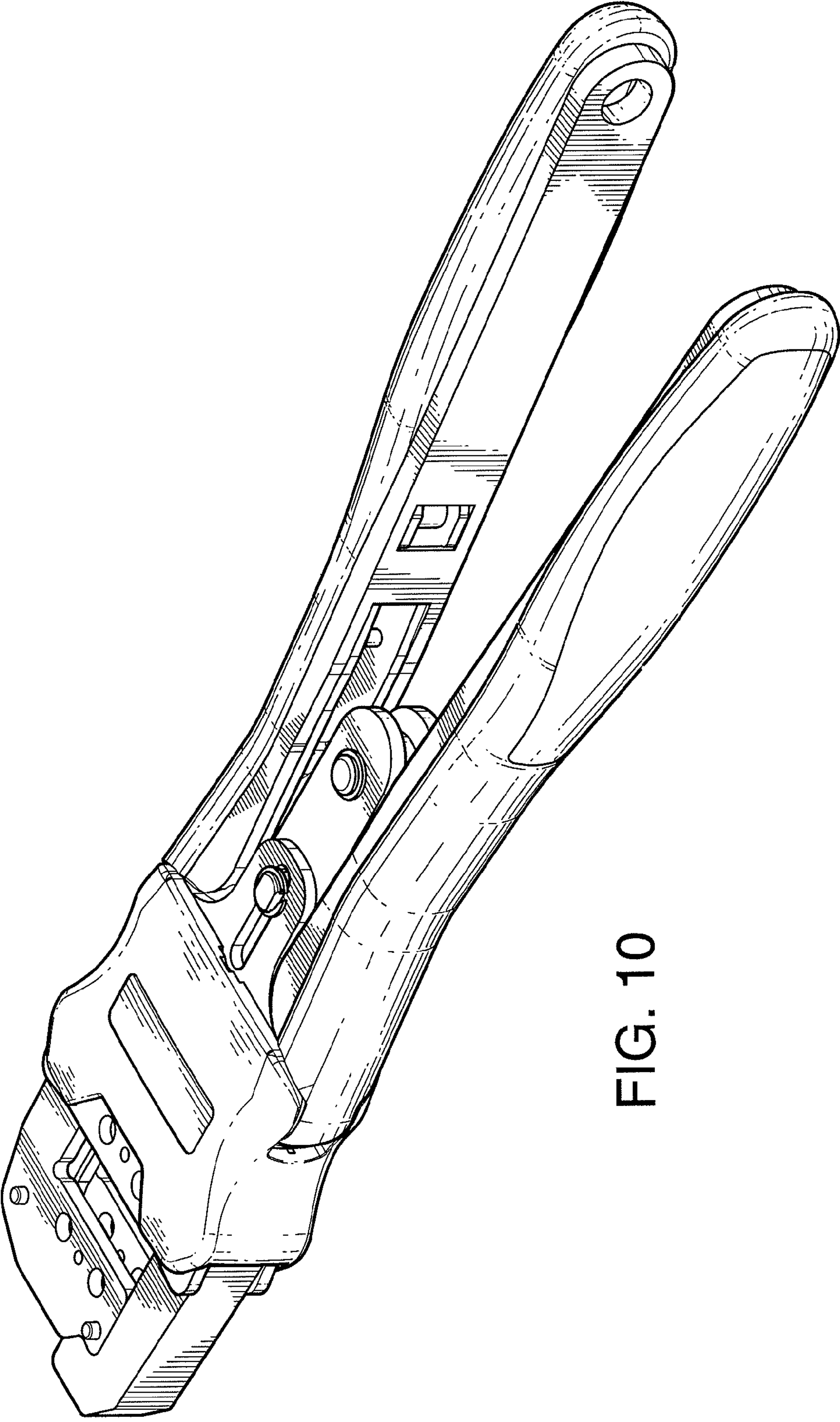

FIG. 10

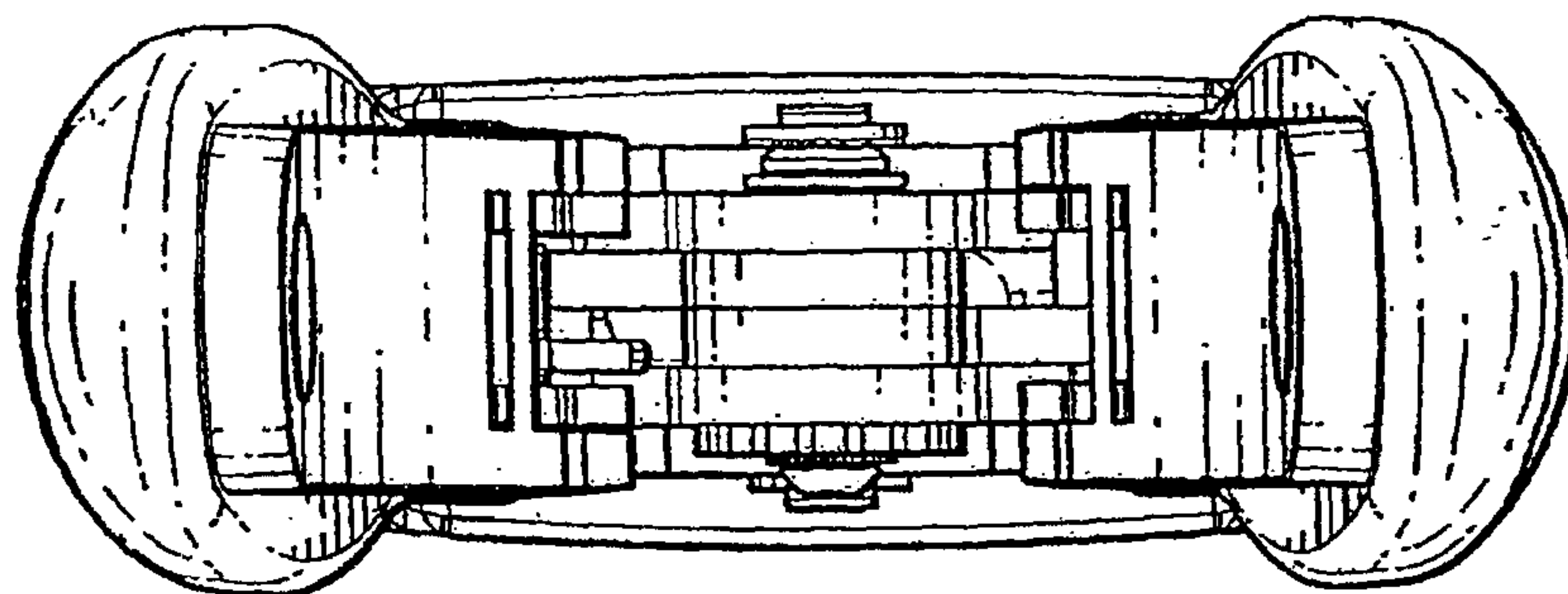

FIG. 11

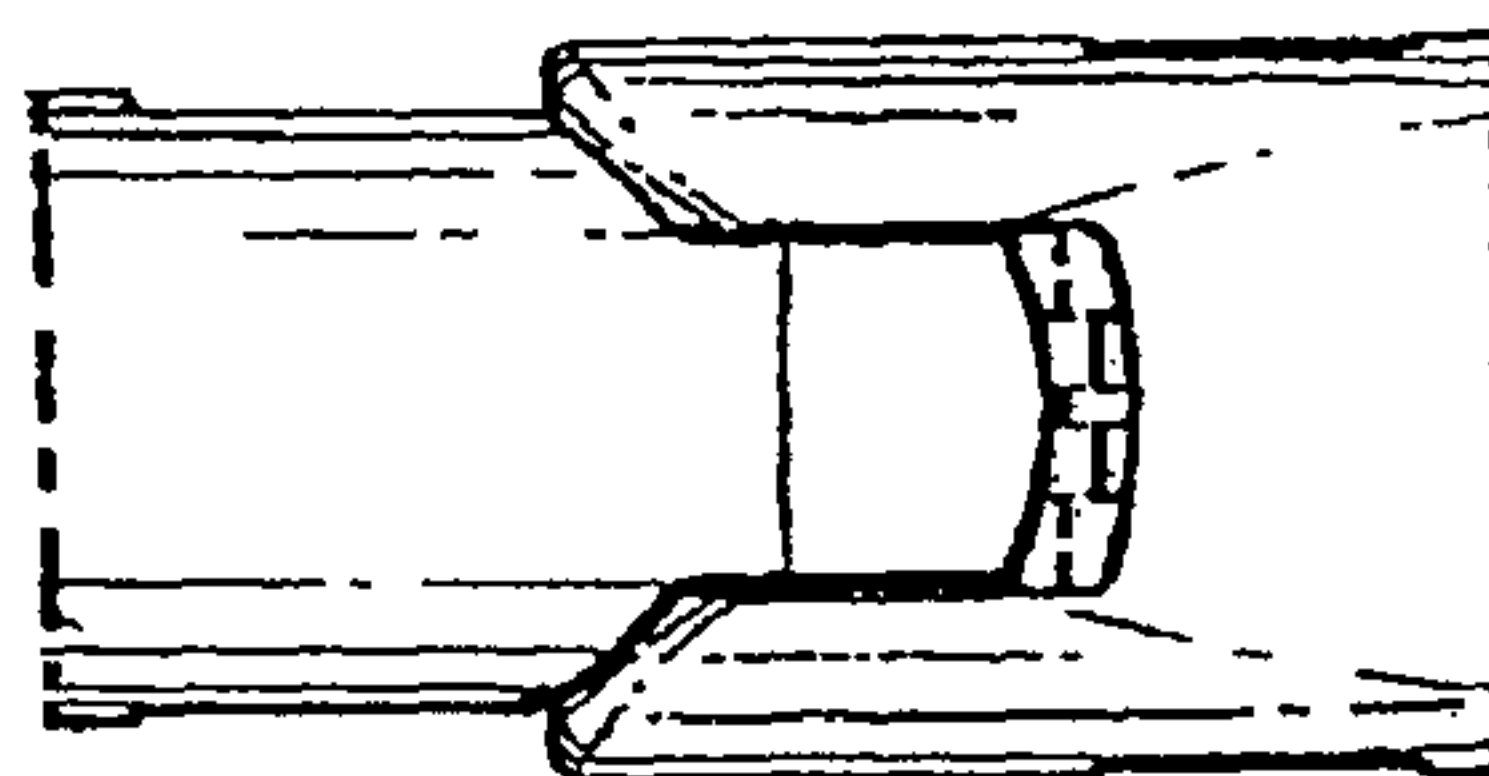

FIG. 12

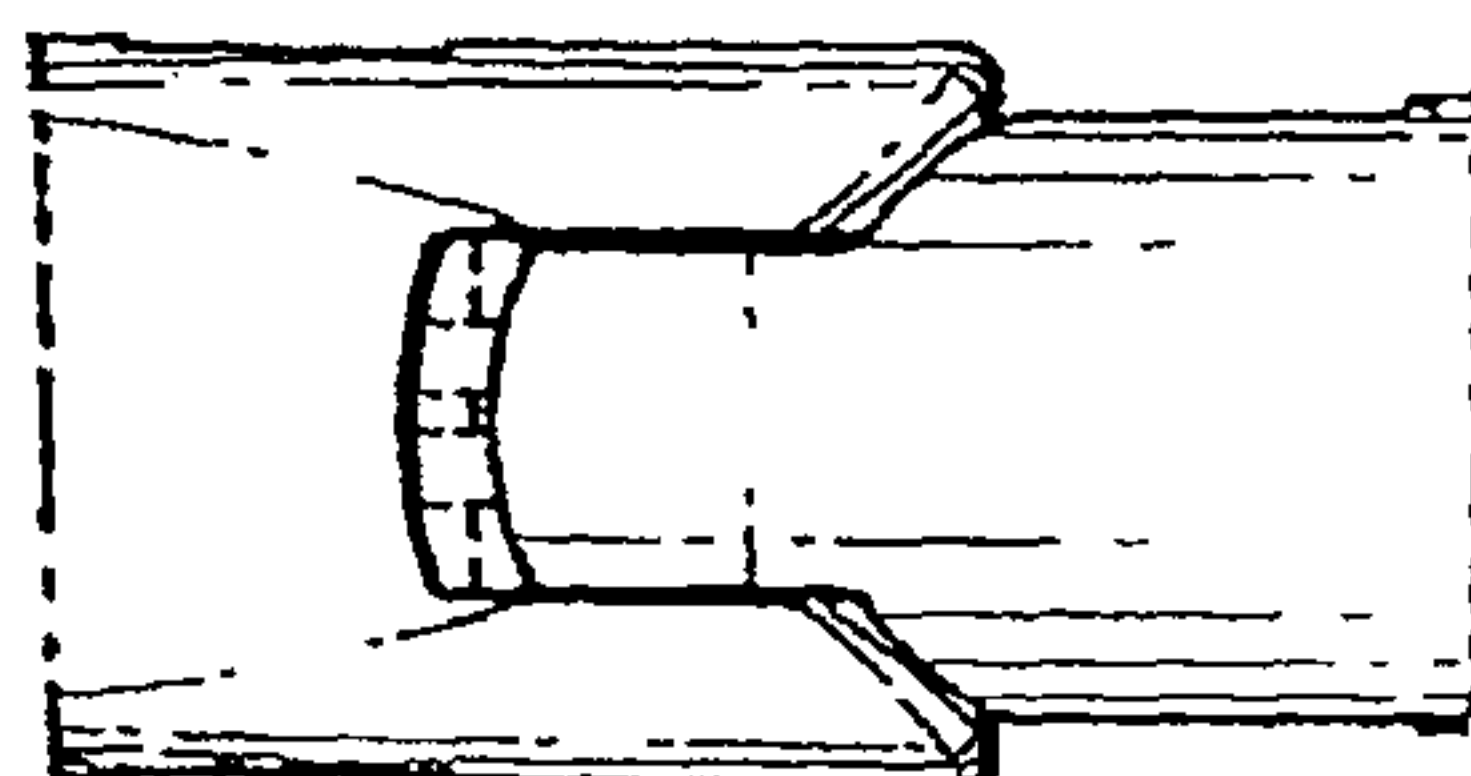

FIG. 13