

US00D693181S

(12) **United States Design Patent**  
**Chase**

(10) **Patent No.:** **US D693,181 S**

(45) **Date of Patent:** **\*\* Nov. 12, 2013**

(54) **BOWL**

(71) Applicant: **Target Brands, Inc.**, Minneapolis, MN (US)

(72) Inventor: **Mark Robert Chase**, Minneapolis, MN (US)

(73) Assignee: **Target Brands, Inc.**, Minneapolis, MN (US)

(\*\*) Term: **14 Years**

(21) Appl. No.: **29/449,134**

(22) Filed: **Mar. 14, 2013**

(51) **LOC (9) Cl.** ..... **07-01**

(52) **U.S. Cl.**  
USPC ..... **D7/586**

(58) **Field of Classification Search**

USPC ..... D7/562, 586, 545, 561, 560, 500, 543,  
D7/360, 361, 552.1, 354, 555, 566, 504,  
D7/587, 565, 601, 602, 505, 558; D1/122;  
D30/130; 220/751, 23.4, 574; D9/643,  
D9/744; 215/382, 400

See application file for complete search history.

(56) **References Cited**

**U.S. PATENT DOCUMENTS**

2,085,238	A *	6/1937	Towell	.....	229/102.5
D110,176	S *	6/1938	Donchian	.....	D7/554.1
D338,809	S *	8/1993	Bennett	.....	D7/584
D384,862	S *	10/1997	Hayes et al.	.....	D7/584
D408,223	S *	4/1999	Henry	.....	D7/545
D432,868	S	10/2000	Tan		
6,141,034	A *	10/2000	McCutchen	.....	348/36
D433,879	S *	11/2000	Emrani	.....	D7/584
D461,102	S *	8/2002	Suzuki	.....	D7/566
D511,437	S *	11/2005	Brown	.....	D7/602
D534,768	S	1/2007	Mansfield		
D541,107	S	4/2007	Mansfield		
D543,787	S *	6/2007	Wasserman et al.	.....	D7/570
D552,423	S *	10/2007	Friedland et al.	.....	D7/545

(Continued)

**OTHER PUBLICATIONS**

“Acer Home HG-TVSK-012 Double Layer Art Decor Heptagon Bowl”, printed from [www.faucetsdiscounter.com/product\\_info.php?manufacturers\\_id=33&products\\_id=578](http://www.faucetsdiscounter.com/product_info.php?manufacturers_id=33&products_id=578) &osCsid=6fe8bc60aed323402d40e61e597b61eb on Mar. 2, 2013 (2 pages).

(Continued)

*Primary Examiner* — Cynthia Underwood

(74) *Attorney, Agent, or Firm* — Griffiths & Seaton PLLC; JoAnn M. Seaton

(57) **CLAIM**

The ornamental design for a bowl, as shown and described.

**DESCRIPTION**

FIG. 1 is a front, perspective view of a bowl showing our new design;

FIG. 2 is a front view thereof;

FIG. 3 is a rear view thereof;

FIG. 4 is a right side view thereof, the left side view being a mirror image of the right side view;

FIG. 5 is a top view thereof; and

FIG. 6 is a bottom view thereof.

FIG. 7 is a front, perspective view of a bowl shown in a configuration of use with the broken lines representing environmental subject matter and forming no part of the claim;

FIG. 8 is a front perspective view showing the bowl in another environment of use;

FIG. 9 is a front view thereof;

FIG. 10 is a rear view thereof;

FIG. 11 is a right side view thereof, the left side view being a mirror image of the right side view;

FIG. 12 is a top view thereof; and,

FIG. 13 is a bottom view thereof.

The features shown in broken lines represent environmental subject matter and form no part of the claim.

**1 Claim, 13 Drawing Sheets**

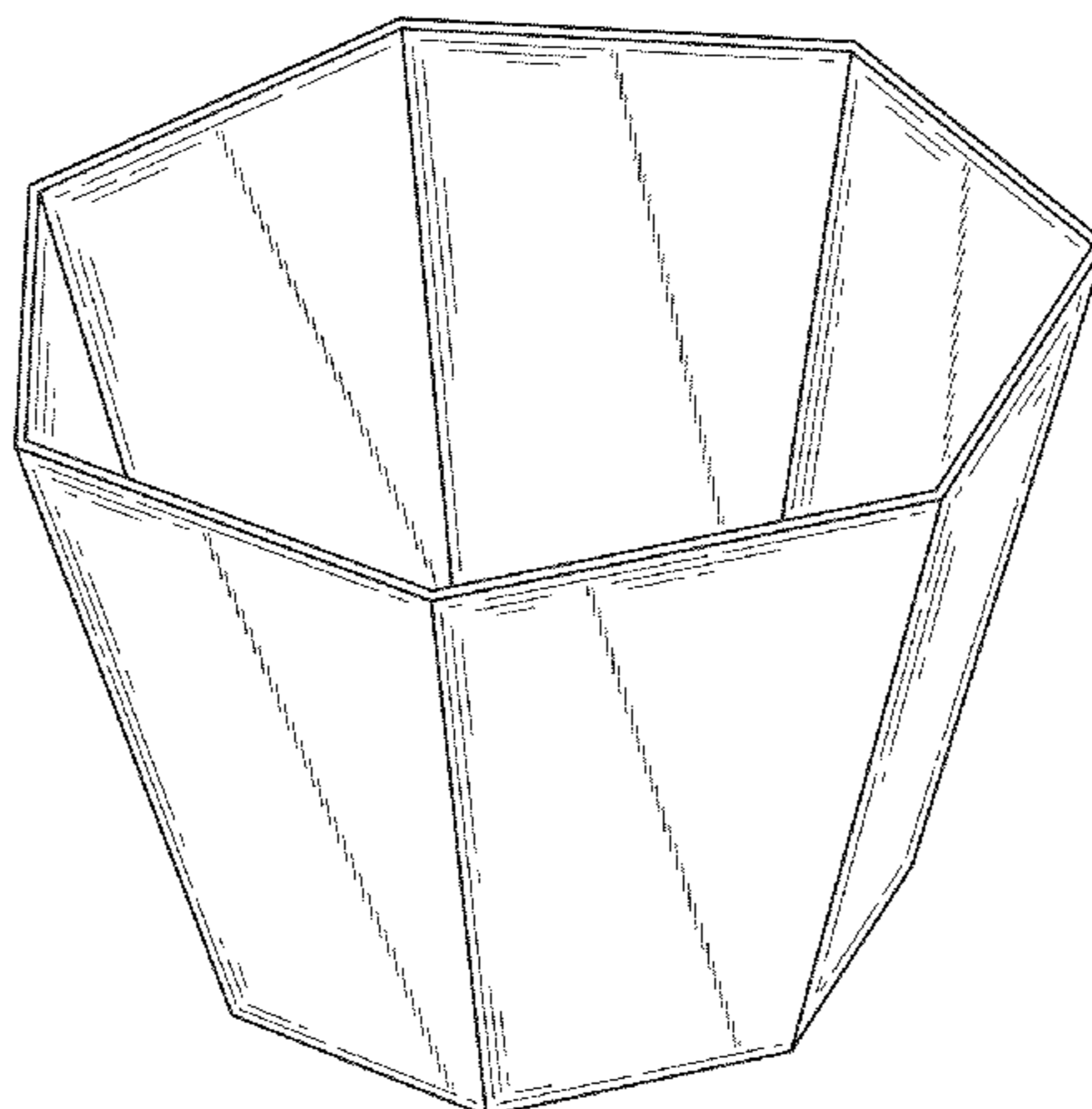

(56)

**References Cited**

**OTHER PUBLICATIONS**

U.S. PATENT DOCUMENTS

D578,414 S	10/2008	Owen	
D578,829 S *	10/2008	Freeman .....	D7/584
D597,311 S	8/2009	Knutson et al.	
D613,837 S *	4/2010	Slothower et al. ....	D23/295
D658,009 S	4/2012	Davis et al.	
D673,813 S *	1/2013	Abel et al. ....	D7/584
D679,148 S *	4/2013	Schwartz et al. ....	D7/629
2001/0015399 A1 *	8/2001	LaMotte .....	248/165

“Stueben Blue, Six Sided Bowl”, printed from [www.nadeausauction.com/lotdetails/?lot=58685](http://www.nadeausauction.com/lotdetails/?lot=58685) on Feb. 11, 2013 (2 pages).

“How I Turn Straight Sided Bowls”, printed from <http://turnspain.com/other-pages/how-to-turn-straight-sided-bowls> publicly available as early Aug. 12, 2012, per <http://web.archive.org> (5 pages).

\* cited by examiner

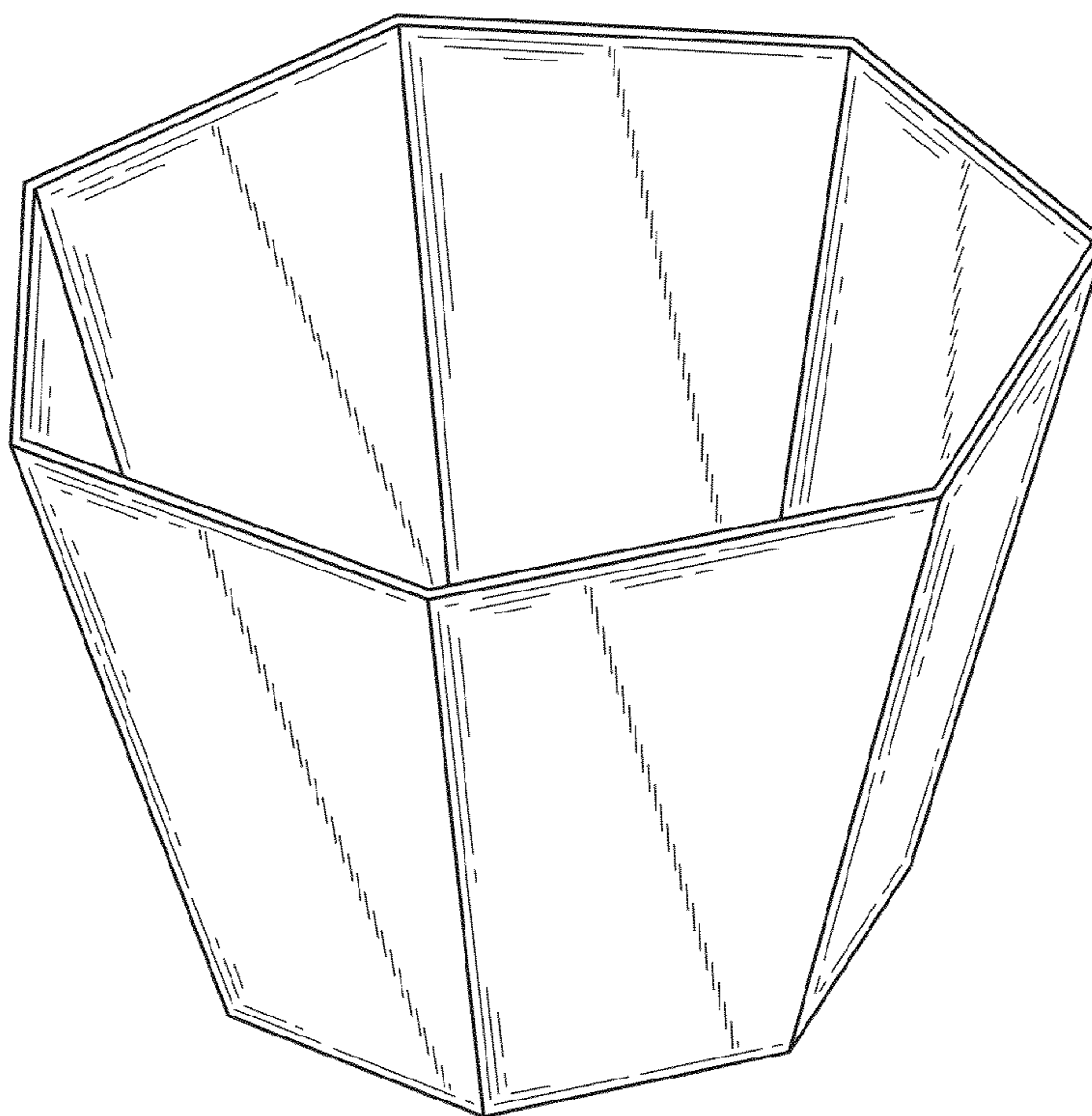

**FIG. 1**

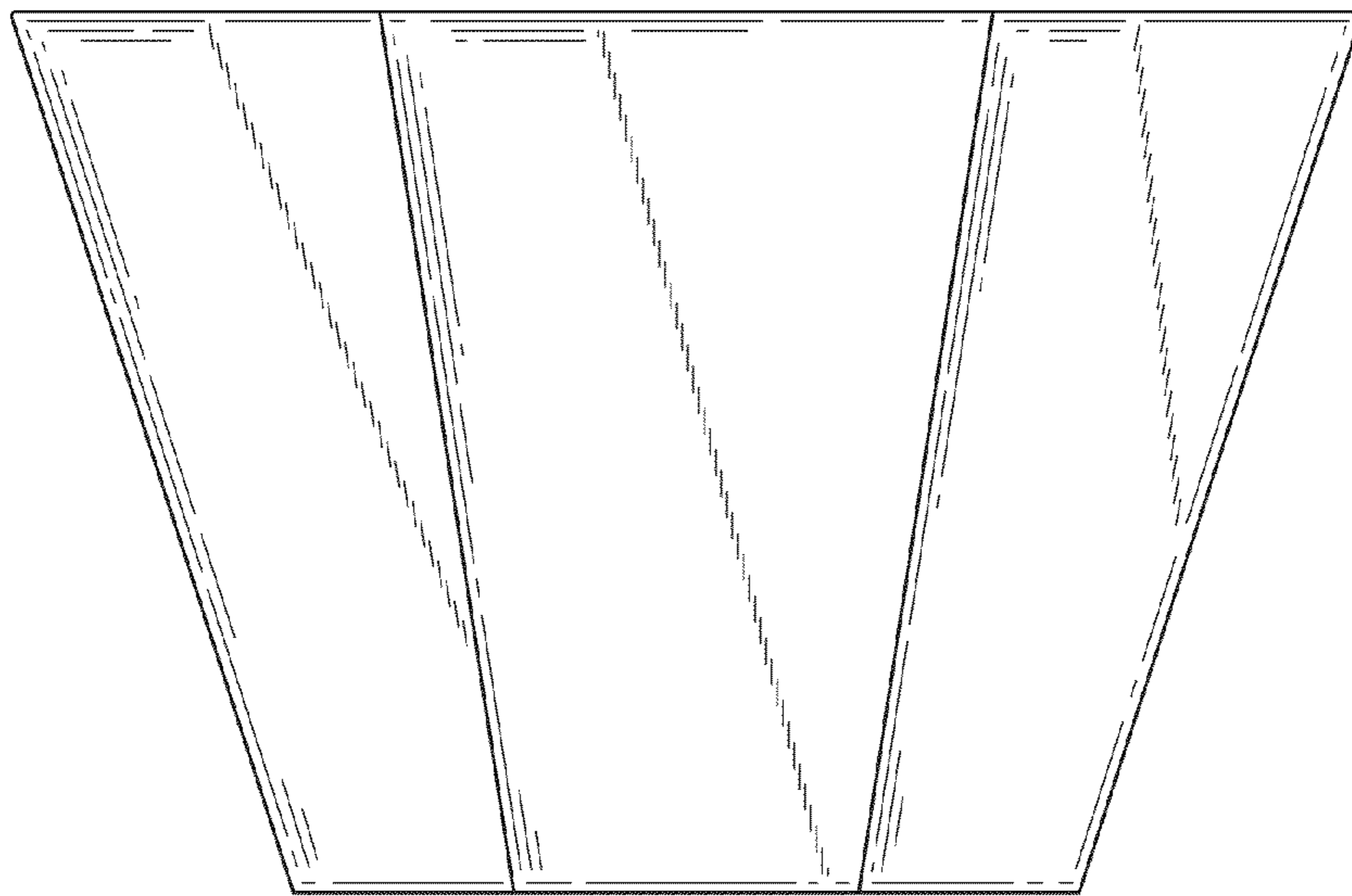

FIG. 2

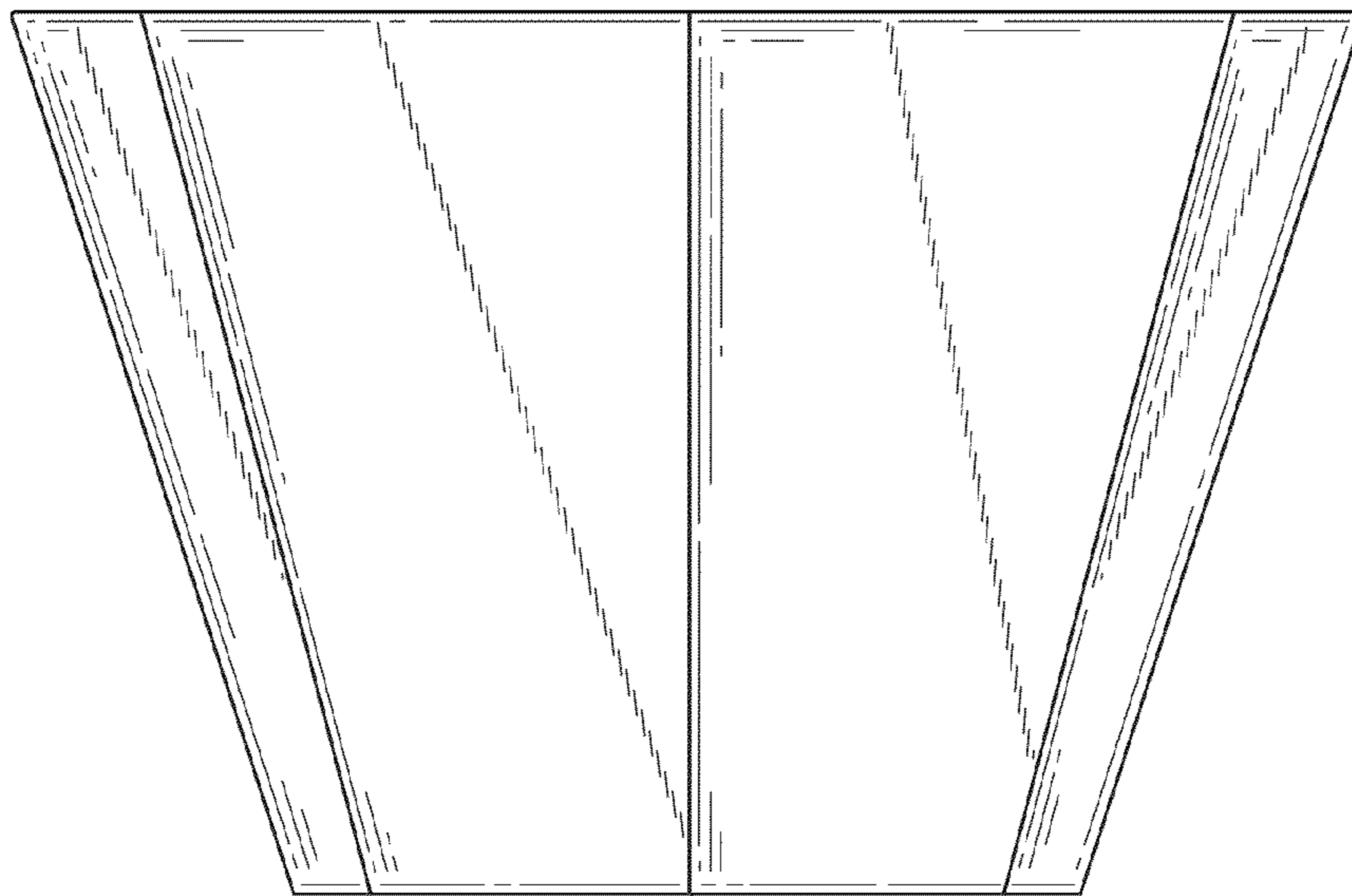

FIG. 3

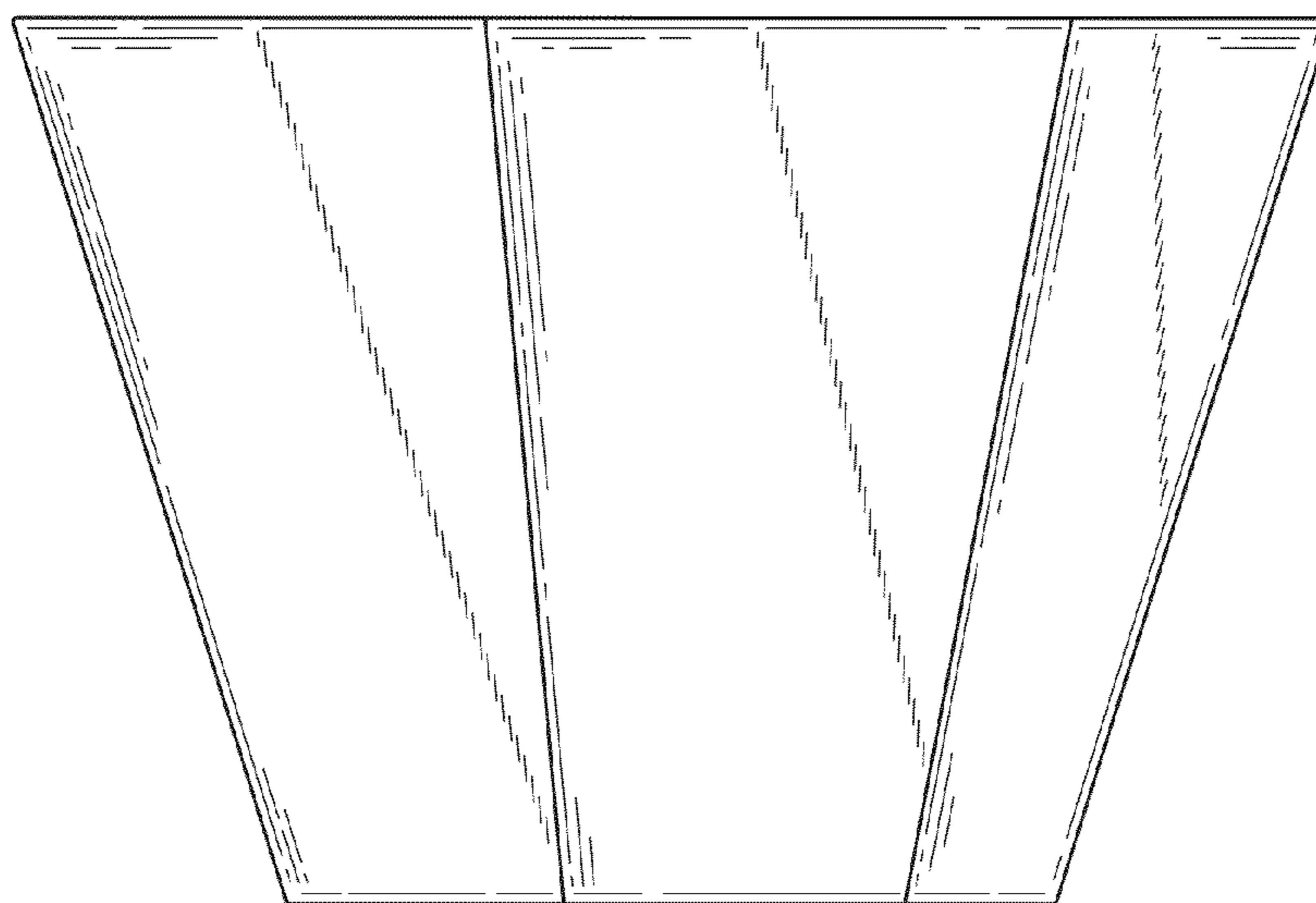

FIG. 4

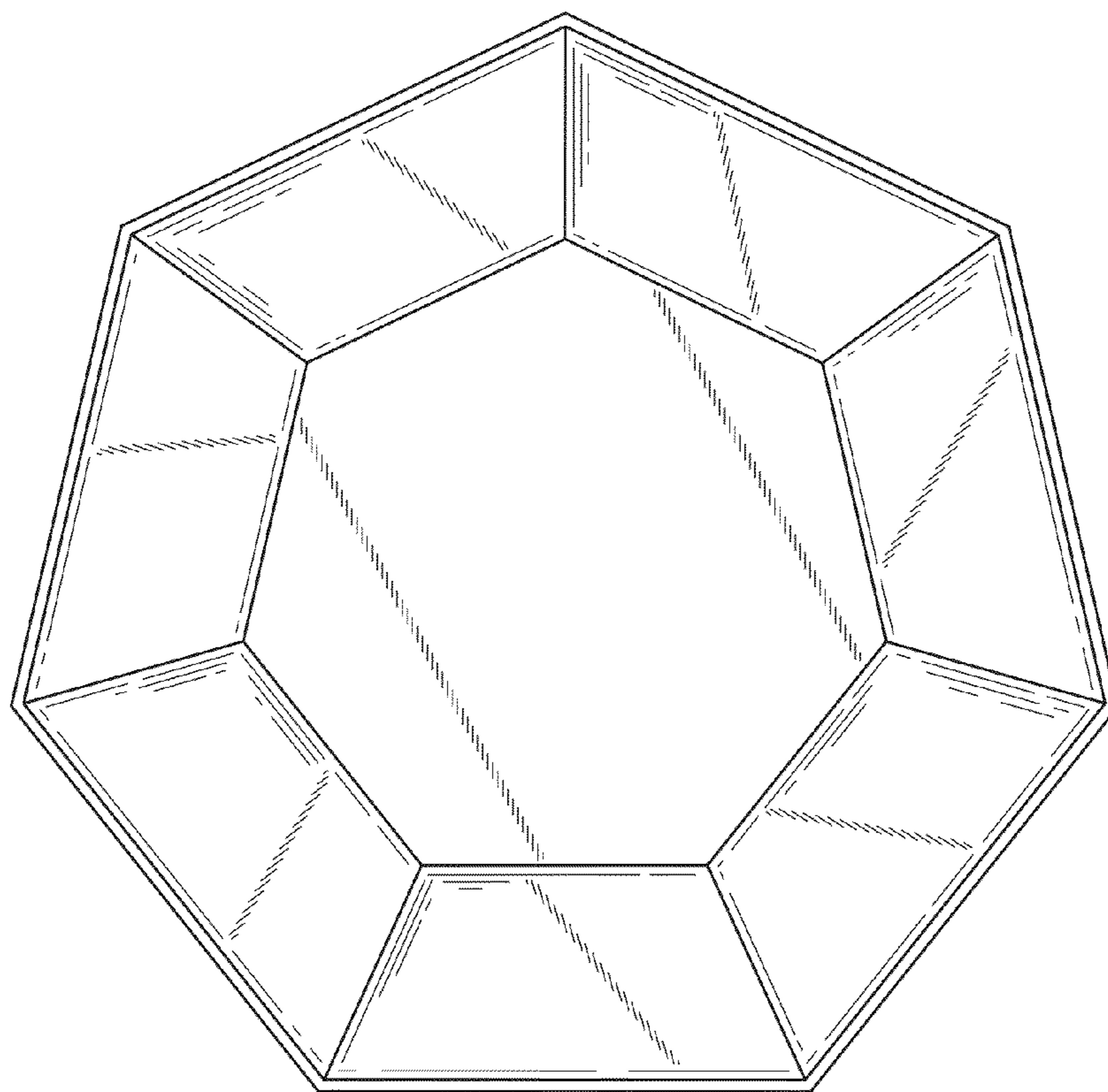

FIG. 5

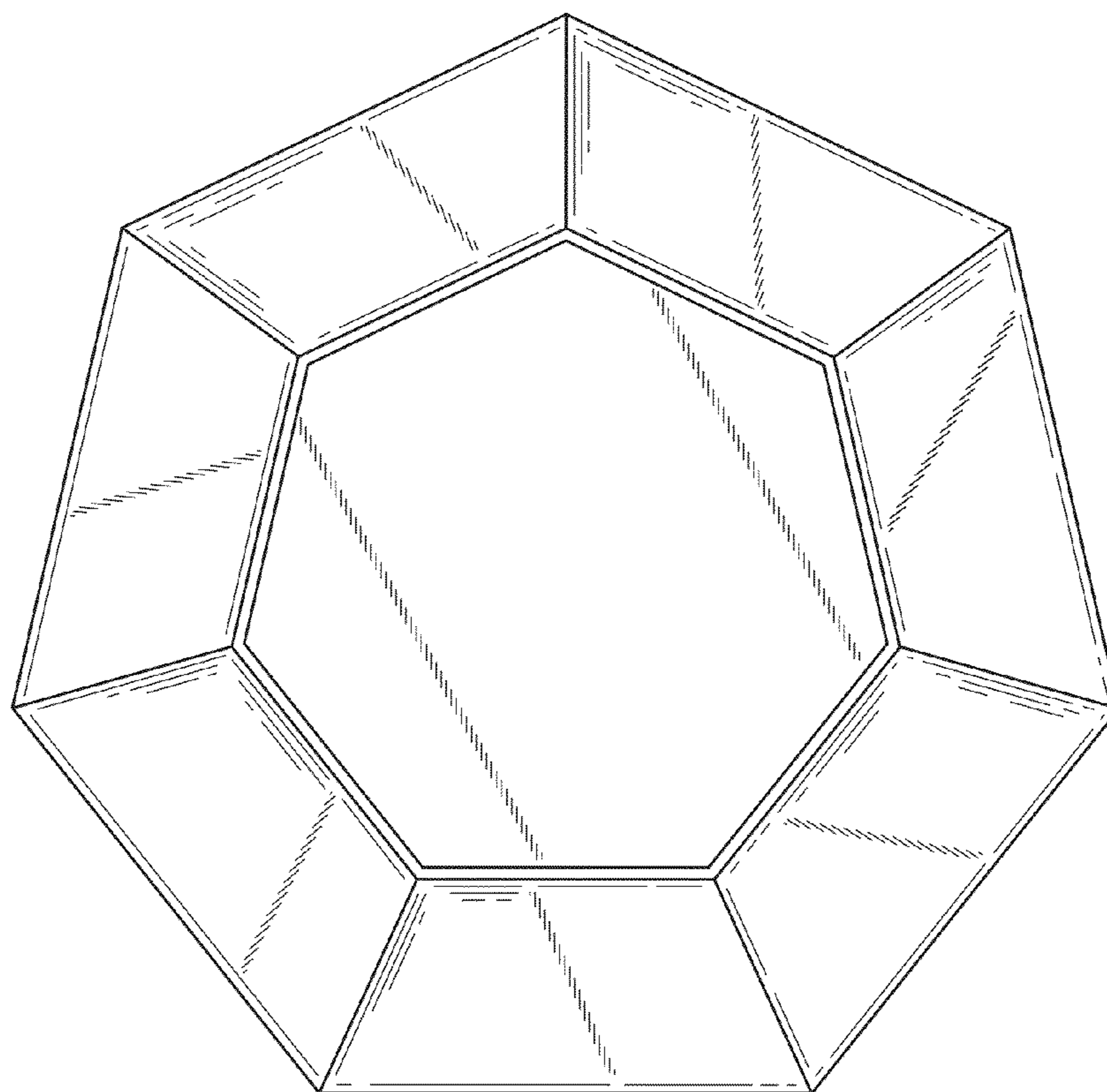

FIG. 6



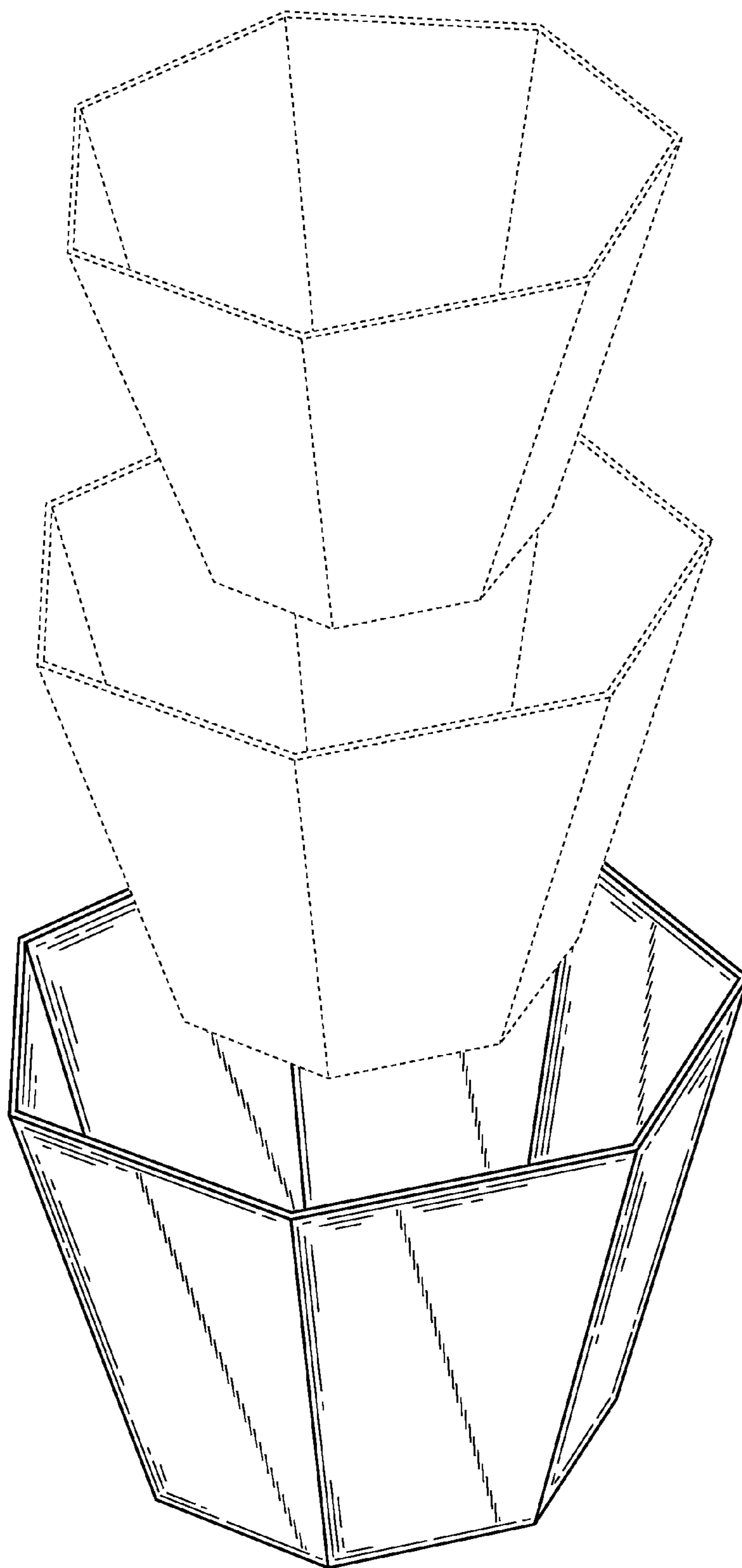

FIG. 7

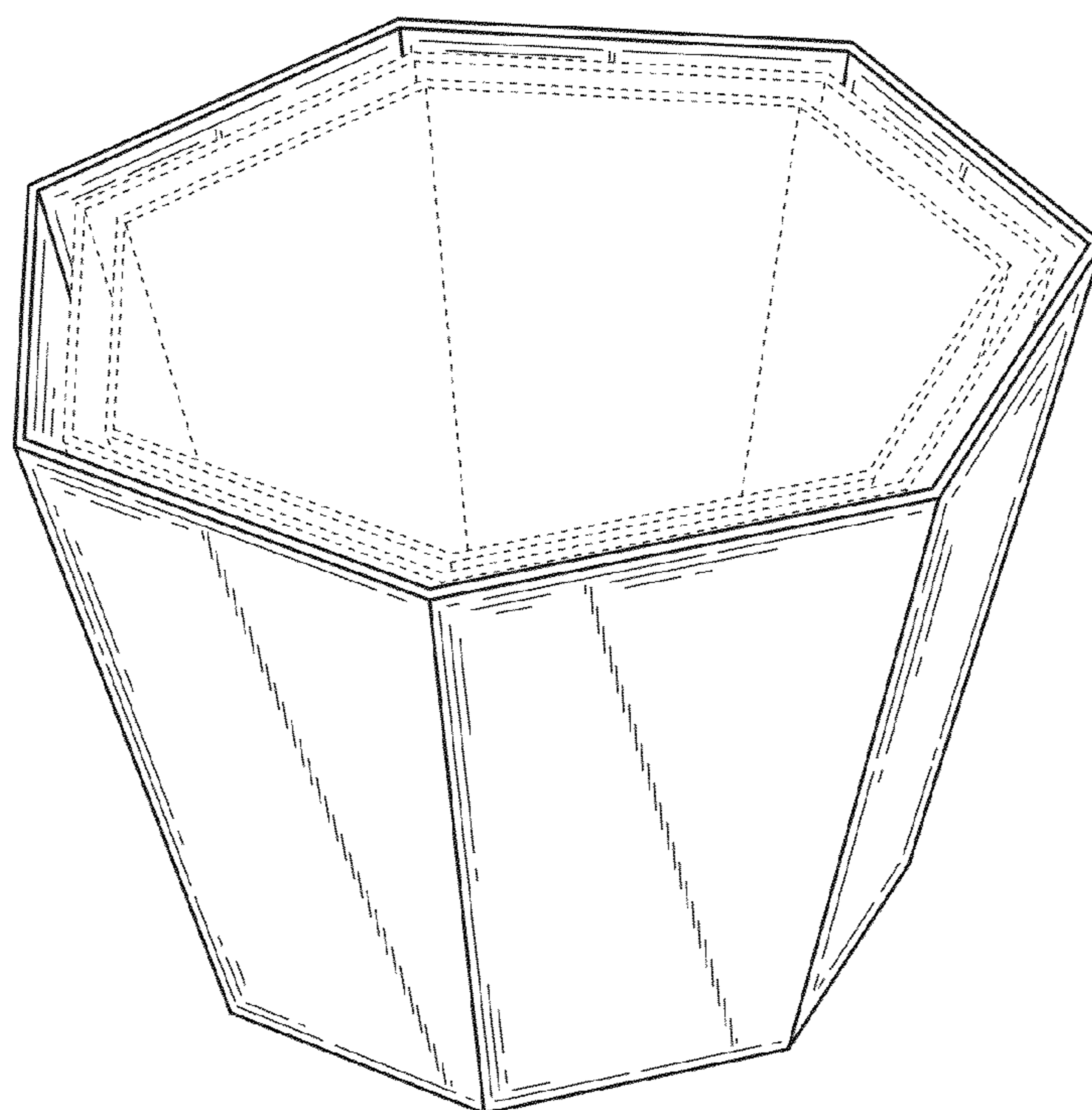

FIG. 8

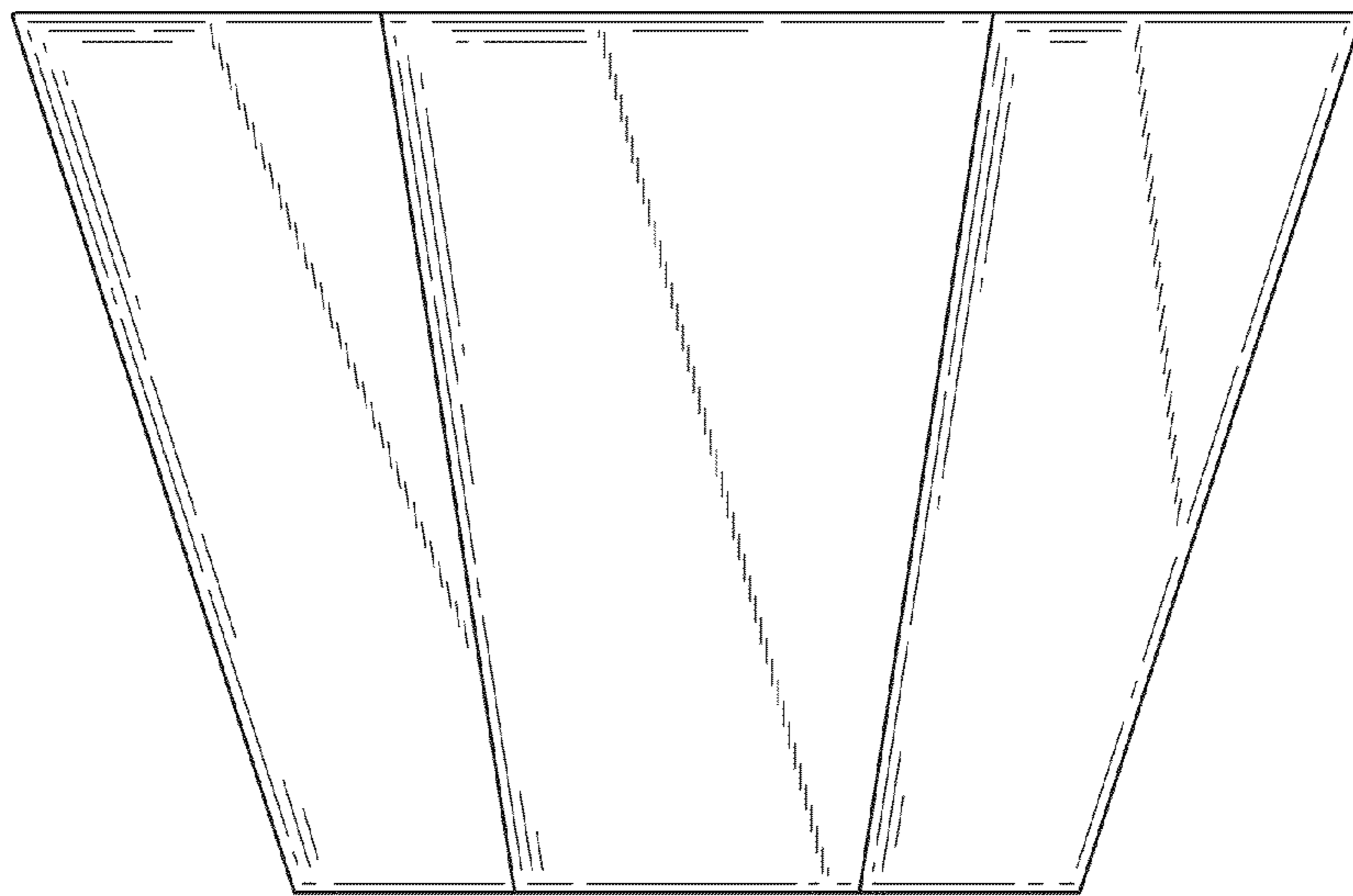

FIG. 9

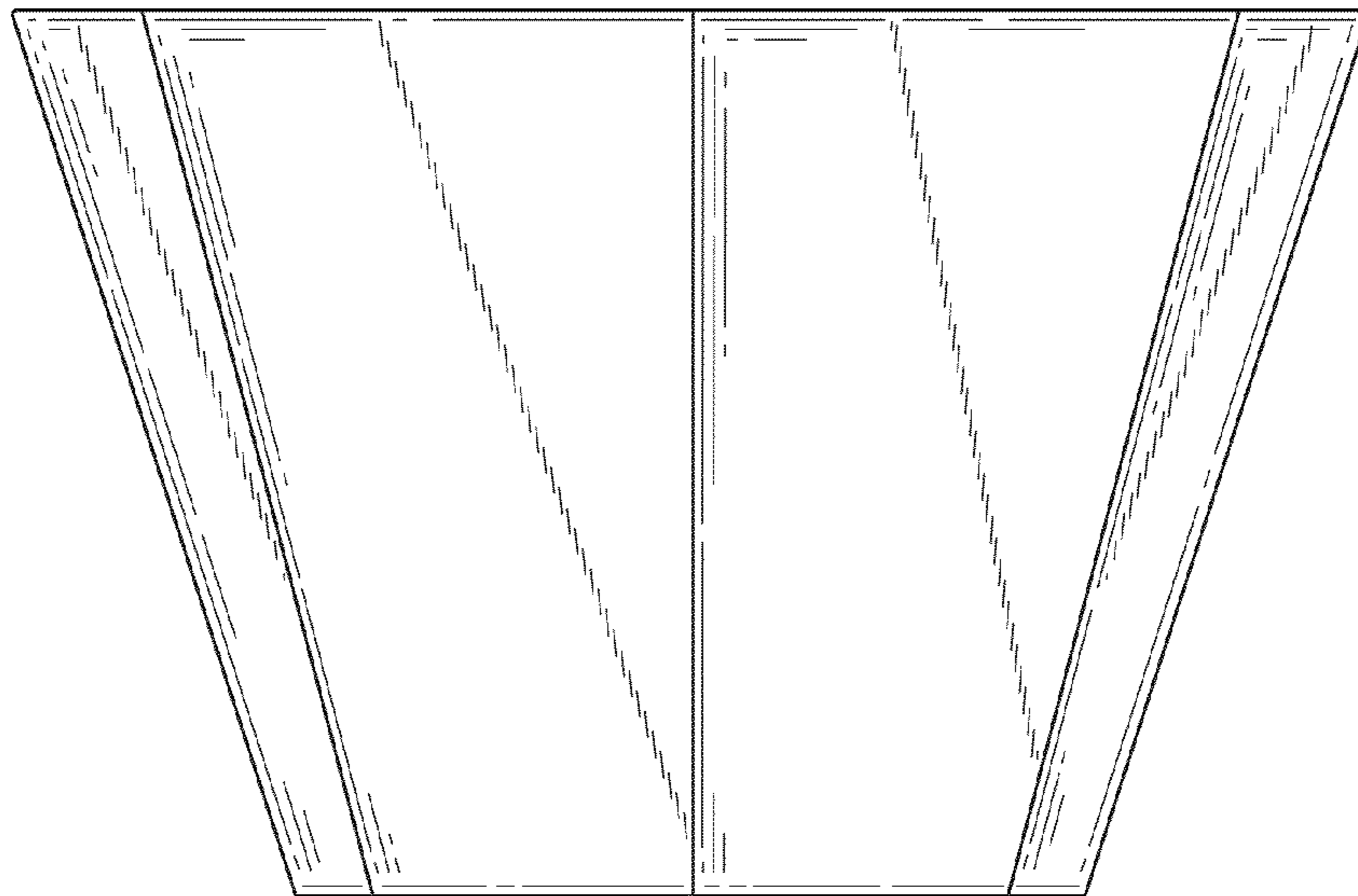

FIG. 10

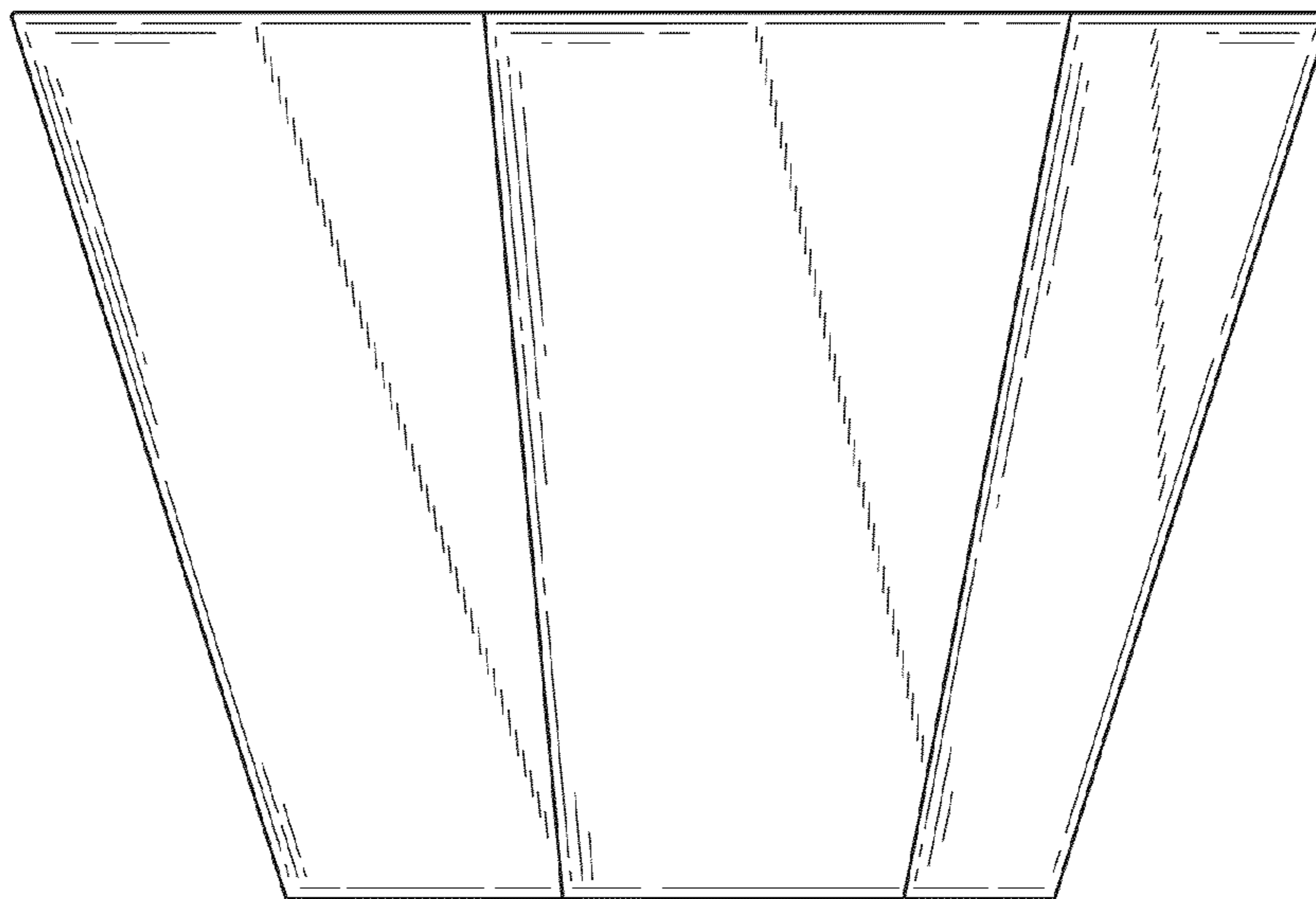

FIG. 11

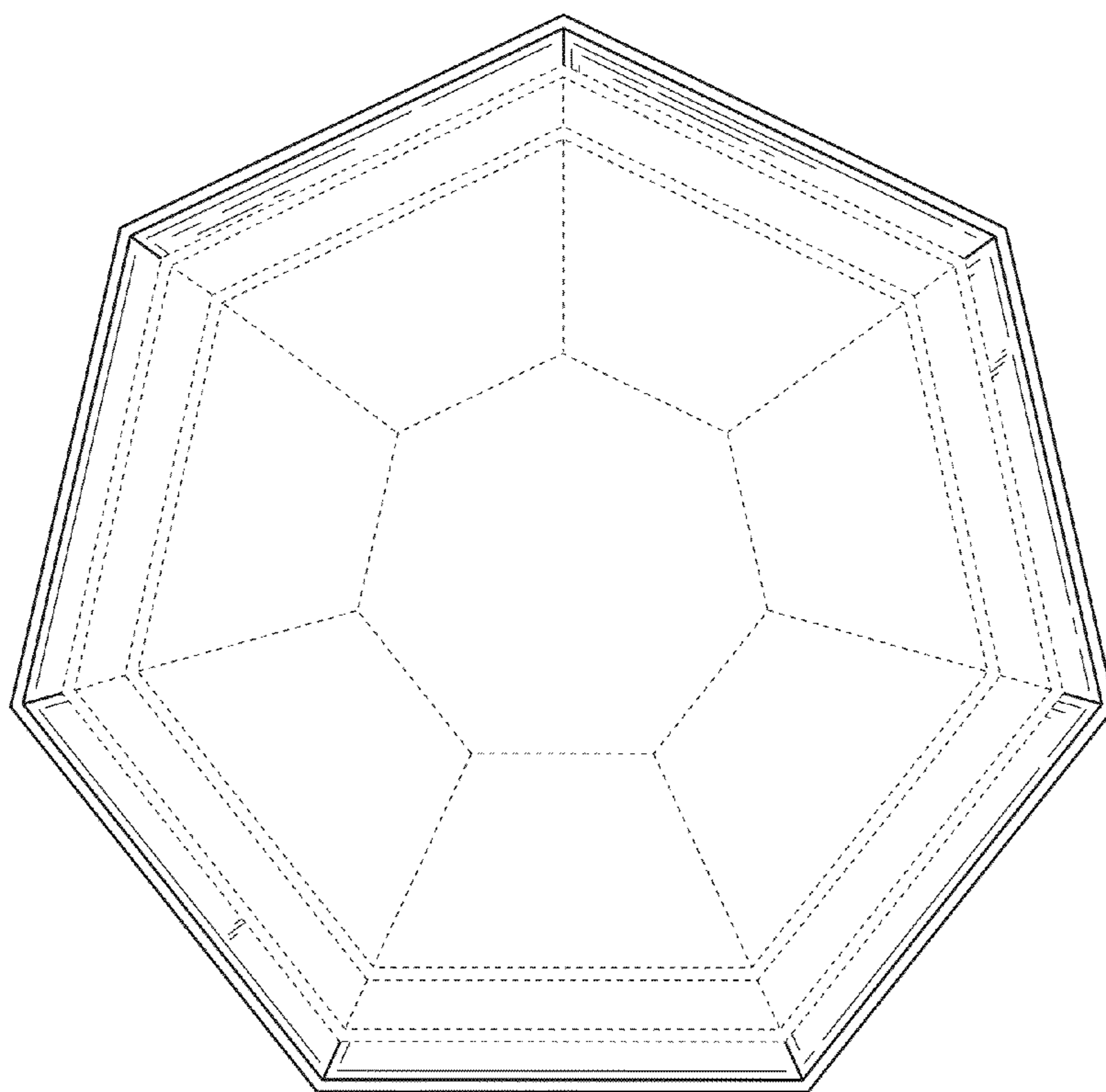

FIG. 12

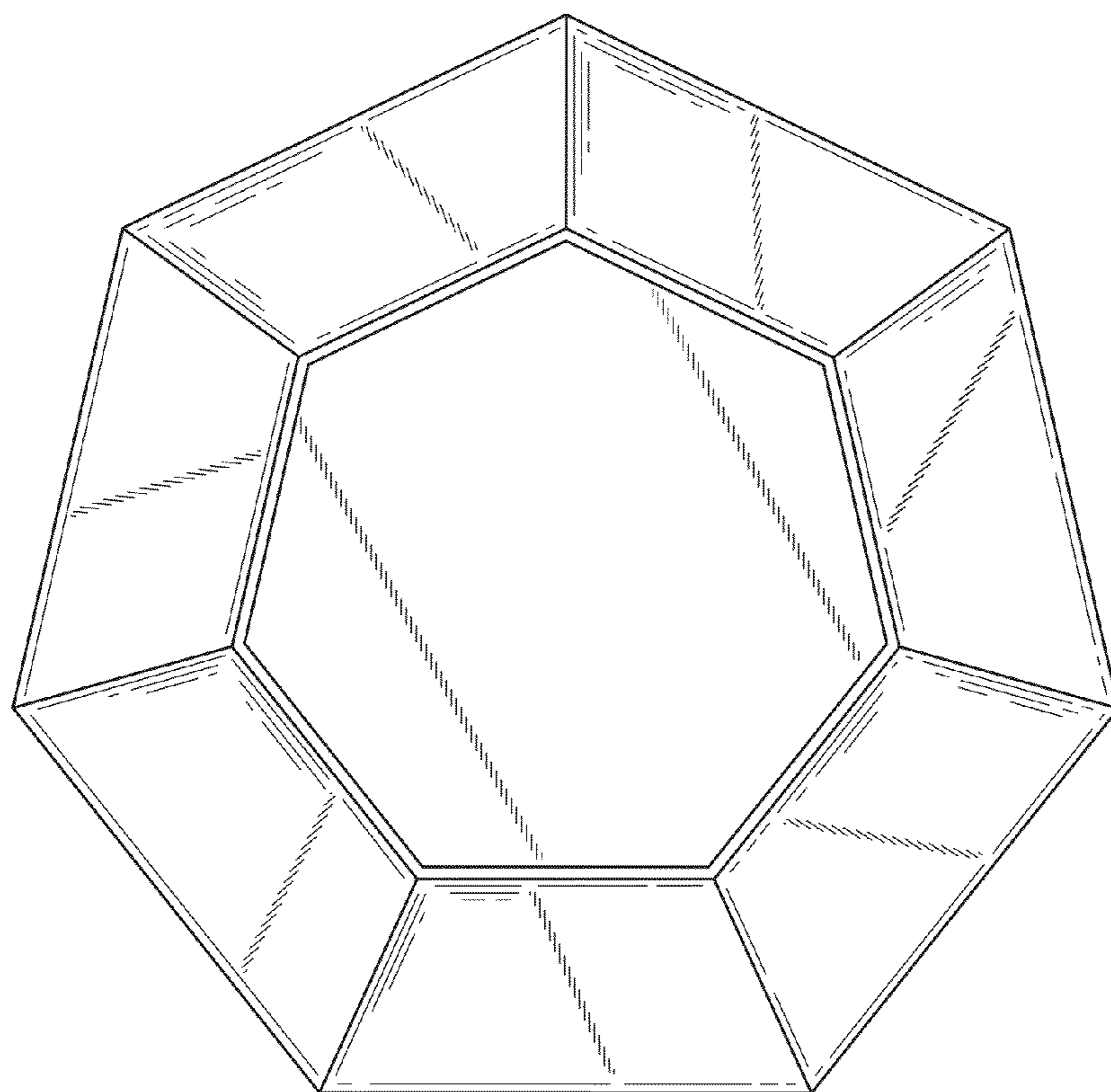

FIG. 13