



US00D693127S

(12) **United States Design Patent**  
**Xi et al.**

(10) **Patent No.:** **US D693,127 S**  
(45) **Date of Patent:** **\*\* Nov. 12, 2013**

(54) **ORAL CARE IMPLEMENT**

FOREIGN PATENT DOCUMENTS

(71) Applicant: **Colgate-Palmolive Company**, New York, NY (US)

CN 3299694 6/2003  
CN 3362295 4/2004

(Continued)

(72) Inventors: **Wen Jin Xi**, Shanghai (CN); **Guang Sheng Guo**, Yangzhou (CN); **Kai Zhang**, Yangzhou (CN)

OTHER PUBLICATIONS

CN 3505549D Registered Design, (Sheng, Dafang) Feb. 15, 2006, [online]. [retrieved on Apr. 10, 2013] Retrieved from the State Intellectual Property Office's CNIPR Database using the Internet: <URL: http://www.cnipr.com>.\*

(Continued)

(\*\*) Term: **14 Years**

*Primary Examiner* — Melanie H Tung  
*Assistant Examiner* — Lavone D Tabor

(21) Appl. No.: **29/433,357**

(74) *Attorney, Agent, or Firm* — Ryan M. Flandro

(22) Filed: **Sep. 28, 2012**

(51) **LOC (9) Cl.** ..... **04-02**

(52) **U.S. Cl.**  
USPC ..... **D4/107**

(57) **CLAIM**

The ornamental design for an oral care implement, as shown and described.

(58) **Field of Classification Search**  
USPC ..... D4/101, 104–112, 124–126, 132–134, D4/136, 138; 15/110, 143.1, 159.1, 160, 15/167.1, 167.2; 132/308–311; 601/139, 601/141, 142

**DESCRIPTION**

FIG. 1 is a right front perspective view of an oral care implement according to a first embodiment of the new design; FIG. 2 is a front view thereof; FIG. 3 is a rear view thereof; FIG. 4 is a left side view thereof; FIG. 5 is a right side view thereof; FIG. 6 is a top view thereof; FIG. 7 is a bottom view thereof; FIG. 8 is a right front perspective view of an oral care implement according to a second embodiment of the new design; FIG. 9 is a front view thereof; FIG. 10 is a rear view thereof; FIG. 11 is a left side view thereof; FIG. 12 is a right side view thereof; FIG. 13 is a top view thereof; and, FIG. 14 is a bottom view thereof.

See application file for complete search history.

(56) **References Cited**

U.S. PATENT DOCUMENTS

D155,668	S	*	10/1949	Zandberg et al.	.....	D4/107
D209,574	S		12/1967	Zandberg et al.		
D276,005	S		10/1984	Fido		
D278,661	S		5/1985	Gelsen		
D375,205	S	*	11/1996	Lewkowicz	.....	D4/104
5,590,436	A	*	1/1997	Wright et al.	.....	15/105
D386,905	S	*	12/1997	Brady et al.	.....	D4/104
D387,203	S		12/1997	Matharu		
D388,254	S		12/1997	Schiffer		

(Continued)

**1 Claim, 8 Drawing Sheets**

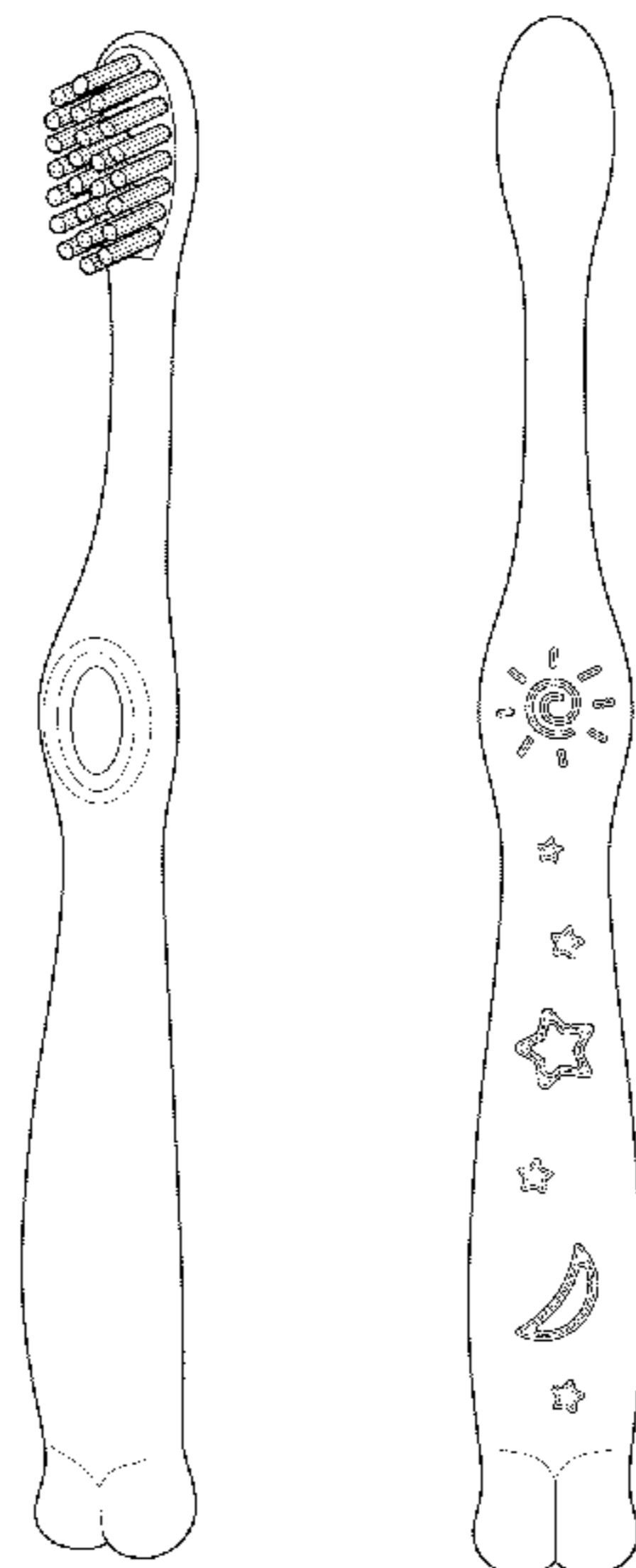

(56)

References Cited

U.S. PATENT DOCUMENTS

D395,757 S 7/1998 Schiffer  
 D397,872 S 9/1998 Moskovich et al.  
 D410,078 S 5/1999 Doubet et al.  
 D410,787 S 6/1999 Barre et al.  
 D411,366 S 6/1999 Landauer  
 D411,683 S 6/1999 Moskovich et al.  
 D414,940 S 10/1999 Weiss  
 D416,686 S 11/1999 Meeker et al.  
 6,026,532 A 2/2000 Catanzaro  
 D426,958 S 6/2000 Moskovich et al.  
 D434,563 S 12/2000 Lim et al.  
 D438,012 S 2/2001 Cheong et al.  
 D438,385 S 3/2001 Harada  
 D442,785 S 5/2001 Harada  
 D446,019 S 8/2001 Hansen et al.  
 D452,380 S 12/2001 Cheong et al.  
 D456,136 S 4/2002 Roehrig  
 D458,453 S 6/2002 Baertschi  
 D458,757 S 6/2002 Dunn et al.  
 D462,178 S 9/2002 Moskovich et al.  
 D463,131 S 9/2002 Winter et al.  
 D463,132 S 9/2002 Winter et al.  
 D463,668 S 10/2002 Yoshimoto et al.  
 D464,796 S 10/2002 Winter et al.  
 D469,960 S 2/2003 Ping  
 D475,530 S 6/2003 Dunn  
 D478,727 S 8/2003 Wong  
 D478,728 S 8/2003 Wong  
 D479,047 S 9/2003 Wong  
 D482,531 S 11/2003 Wong  
 D483,568 S 12/2003 Jamson  
 D488,301 S 4/2004 Xi  
 D498,362 S 11/2004 Xi  
 D499,885 S 12/2004 Xi  
 D505,264 S 5/2005 Chen  
 D510,482 S 10/2005 Jimenez  
 D510,807 S 10/2005 Jimenez  
 D513,126 S 12/2005 Jimenez et al.  
 D514,813 S 2/2006 Moskovich et al.  
 D531,413 S 11/2006 Wong  
 D531,414 S 11/2006 Wong  
 D555,359 S 11/2007 Chen et al.  
 D558,980 S 1/2008 Jimenez et al.  
 D559,546 S 1/2008 Wong  
 D565,844 S 4/2008 Wong  
 D577,493 S 9/2008 Wong  
 D585,197 S 1/2009 Crossman  
 D596,406 S \* 7/2009 Xi ..... D4/104  
 D606,319 S \* 12/2009 Xi ..... D4/104  
 7,774,888 B2 8/2010 Chen

D635,775 S 4/2011 Kalbfeld et al.  
 D640,469 S 6/2011 Nanda  
 D652,627 S 1/2012 Nanda  
 D664,359 S \* 7/2012 Xi et al. .... D4/104

FOREIGN PATENT DOCUMENTS

CN 3376498 7/2004  
 CN 3406087 11/2004  
 CN 3409456 12/2004  
 CN 3409461 12/2004  
 CN 3420573 1/2005  
 CN 3438265 4/2005  
 CN 3616973 3/2007  
 CN 300937681 6/2009  
 CN 301525815 4/2011  
 HK 0601011.0 5/2006  
 JP 1397459 S \* 9/2010  
 KR 30-0486411-1 S \* 7/2008  
 KR 30-0528940 S \* 5/2009  
 MY 01-00095 2/2001  
 RU D51563 12/2002  
 RU D52578 6/2003  
 RU D53051 9/2003  
 RU D54969 8/2004  
 RU D55985 1/2005  
 RU D58058 11/2005  
 RU D69782 4/2009  
 RU D75347 7/2010  
 RU D78891 7/2011  
 TR 200605294 11/2006

OTHER PUBLICATIONS

CN 3340090 Registered Design, (Chen, Xinglong) Dec. 17, 2003, [online], [retrieved on Apr. 4, 2011] Retrieved from the Questel Intellectual Property Portal Design Database using the Internet: <URL: <http://www.orbit.com>>.\*  
 DE 40704608-0002 Registered Design, (Bürstenmann GmbH) Dec. 10, 2007, [online], [retrieved on Apr. 11, 2013]. Retrieved from the Designs Register of the German Patent and Trade Mark Office using the Internet: <URL: <http://register.dmpa.de>>.\*  
 Baby Best Buy in Thailand Oral-B Stages 2 website, 2006, <http://www.babybestbuy.in.th/shop/oral-b-kid-toothbrush>.  
 Colgate Fundraiser Australia website, 2012, <http://www.colgatefundraiser.com.au>.  
 Eeendeavors Colgate Kids Toothbrush website, 2012, <http://eeendeavors.com/0-75-off-colgate-kids-toothbrush>.  
 Silver Care Antibacterial Range—Kids Toothbrushes website, 2012, [http://www.piave.com/ing/line\\_silver\\_care\\_kiddies\\_tooth-brushes](http://www.piave.com/ing/line_silver_care_kiddies_tooth-brushes).

\* cited by examiner

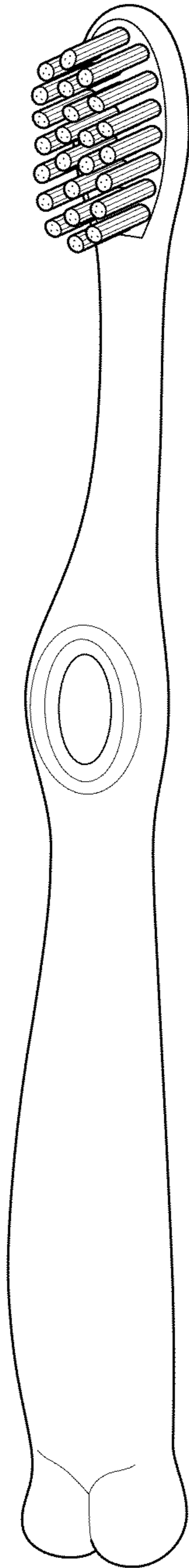

FIG. 1

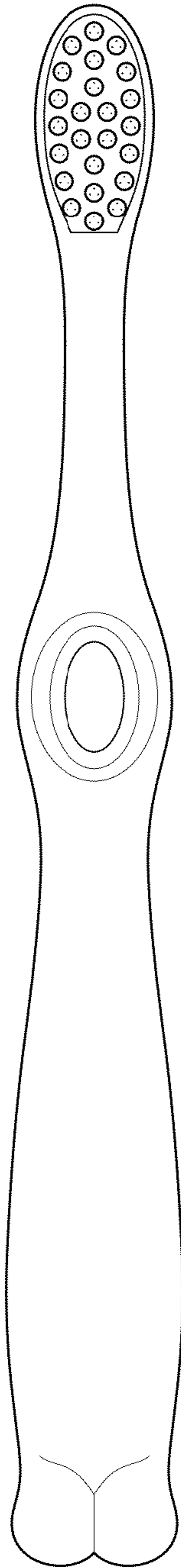

FIG. 2



FIG. 3

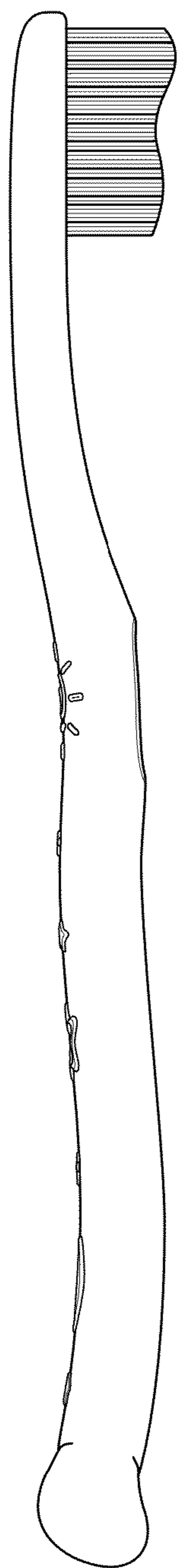

FIG. 4

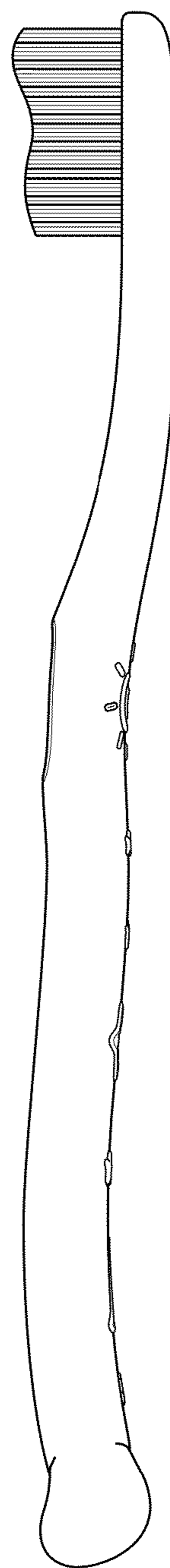

FIG. 5

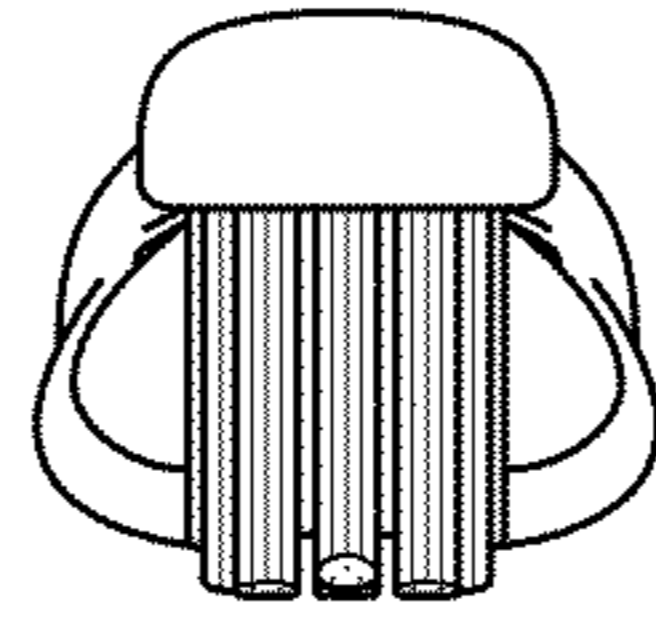

FIG. 6

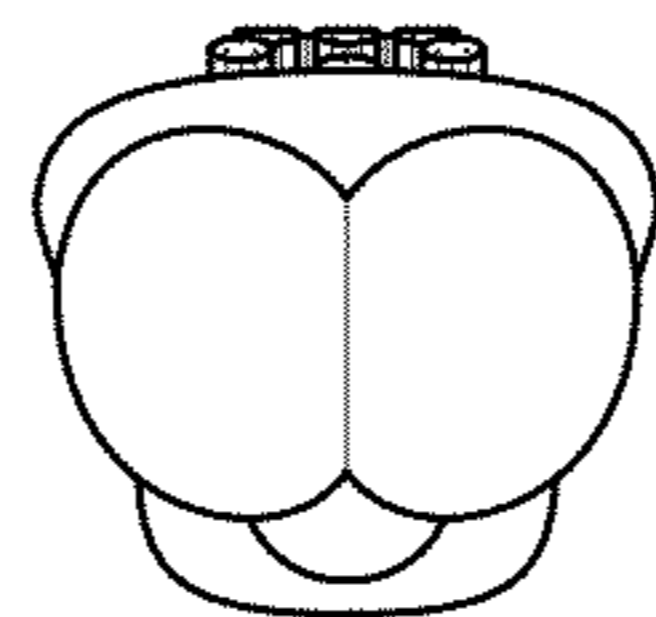

FIG. 7

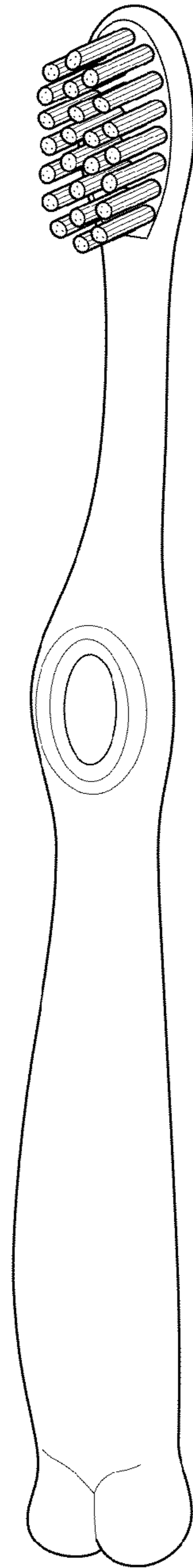

FIG. 8

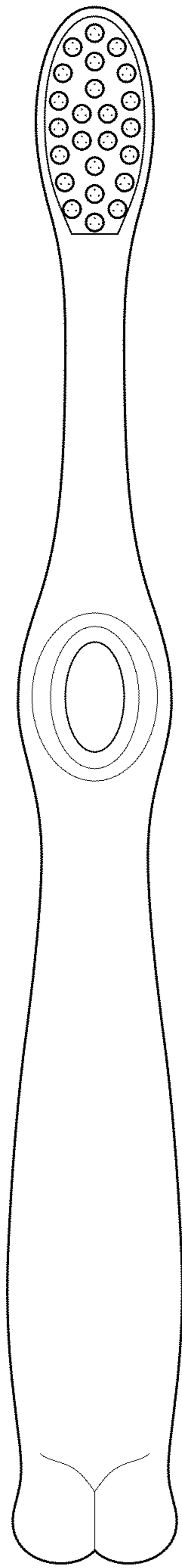

FIG. 9

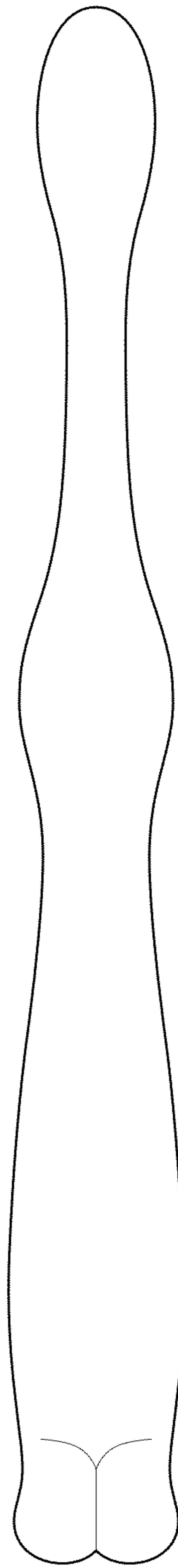

FIG. 10



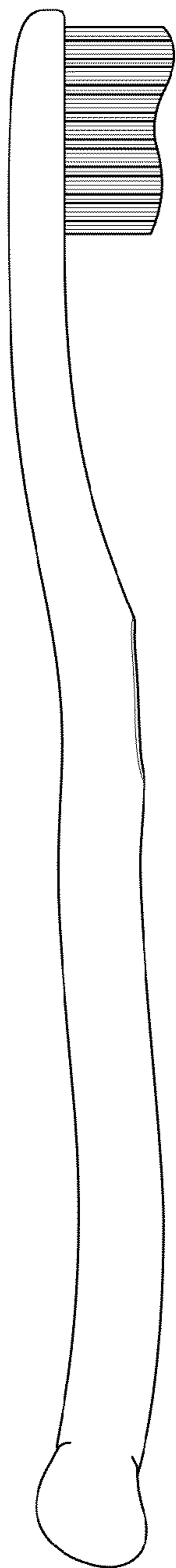

FIG. 11

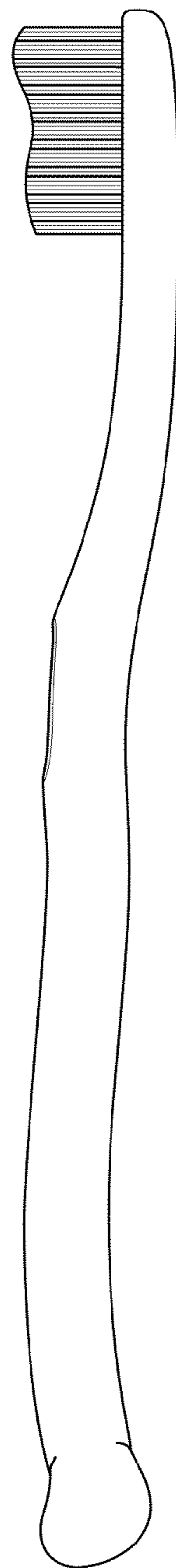

FIG. 12

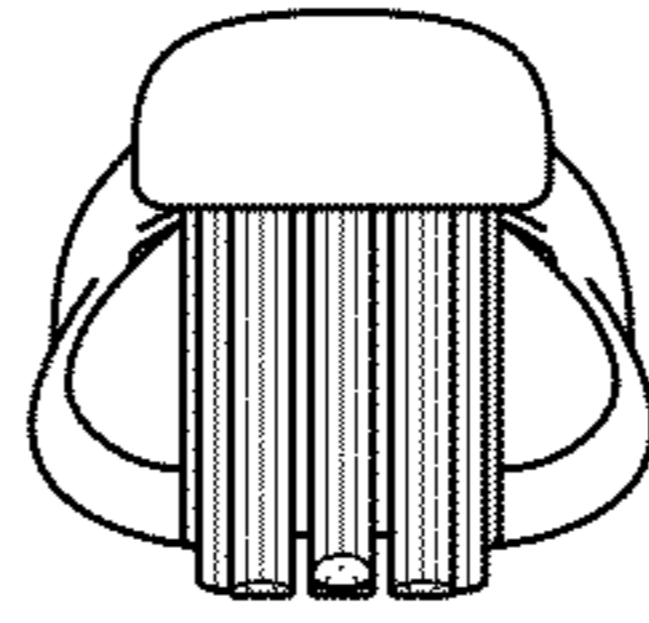

FIG. 13

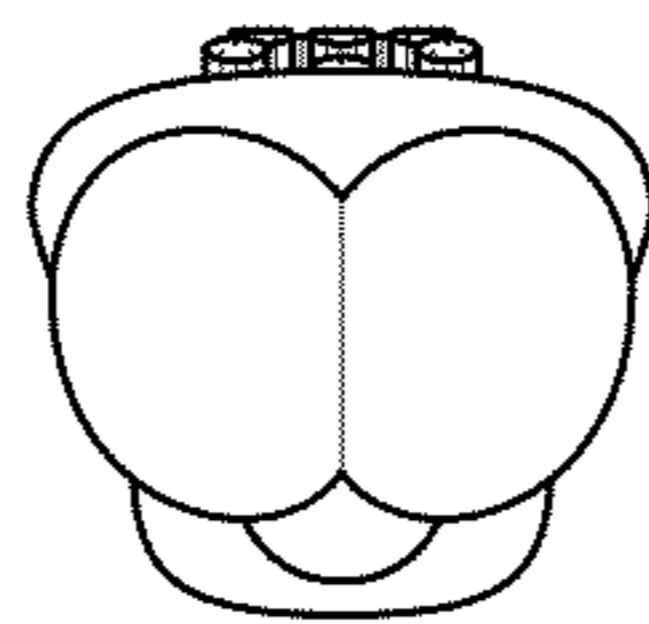

FIG. 14