

US00D692995S

(12) **United States Design Patent**
Cogswell

(10) **Patent No.:** **US D692,995 S**
(45) **Date of Patent:** **** Nov. 5, 2013**

(54) **ODOR ELIMINATING APPARATUS FOR TOILETS AND THE LIKE**

D667,944 S *	9/2012	Richard et al.	D23/366
2006/0277671 A1	12/2006	Jones	
2008/0109950 A1	5/2008	Exiga	
2011/0041241 A1	2/2011	Frank	
2011/0203040 A1	8/2011	Brown	

(71) Applicant: **Potty Fresh Pro LLC**, Ft. Lauderdale, FL (US)

FOREIGN PATENT DOCUMENTS

(72) Inventor: **David Lee Cogswell**, Ft. Lauderdale, FL (US)

CA	1305295	9/1989
CA	2522714	11/2005
CN	2139601	8/1993

(73) Assignee: **Cogswell Innovation, Inc.**, Fort Lauderdale, FL (US)

(Continued)

(**) Term: **14 Years**

OTHER PUBLICATIONS

(21) Appl. No.: **29/452,306**

Chverchko, "Indiana Inventor to Exhibit "Bowl Breeze" at America's Largest Invention Show", Inpex, Apr. 24, 2007.

(22) Filed: **Apr. 15, 2013**

(Continued)

(51) **LOC (9) Cl.** **28-99**

Primary Examiner — Sandra Snapp

(52) **U.S. Cl.**
USPC **D23/366**

(74) *Attorney, Agent, or Firm* — Gottlieb, Rackman & Reisman, P.C.

(58) **Field of Classification Search**
USPC D23/355-369; D28/5, 6; 261/DIG. 17, 261/DIG. 42, DIG. 65, DIG. 88, DIG. 89, 261/DIG. 47, DIG. 55, DIG. 70; 392/356, 392/390, 392, 394, 395; 239/34, 44, 53, 55, 239/56, 326, 60, 308
See application file for complete search history.

(57) **CLAIM**

The ornamental design for an odor eliminating apparatus for toilets and the like, as shown and described.

DESCRIPTION

(56) **References Cited**

U.S. PATENT DOCUMENTS

3,869,737 A	3/1975	Stevenson	
4,317,242 A	3/1982	Stamper	
4,472,841 A	9/1984	Faulkner	
6,041,449 A	3/2000	Brown	
6,457,186 B1	10/2002	Stewart	
6,643,850 B2	11/2003	Chasen	
6,678,900 B2	1/2004	Ware	
6,948,192 B2	9/2005	Hipponsteel	
7,797,766 B2	9/2010	Ellinger	
7,987,527 B1	8/2011	Shumaker	
D667,750 S *	9/2012	McKay	D11/143

FIG. 1 is a perspective view showing my new design; FIG. 2 is a top plan view thereof; FIG. 3 is a front elevational view thereof; FIG. 4 is a right side elevational view thereof; FIG. 5 is a left side elevational view thereof; FIG. 6 is a rear elevational view thereof; FIG. 7 is a bottom plan view thereof; and, FIG. 8 is a perspective view showing an odor eliminating apparatus positioned on a toilet. The broken lines in FIG. 8 showing the toilet and in FIG. 6 showing screws are for the purposes of illustrating environment and form no part of the claimed design.

1 Claim, 5 Drawing Sheets

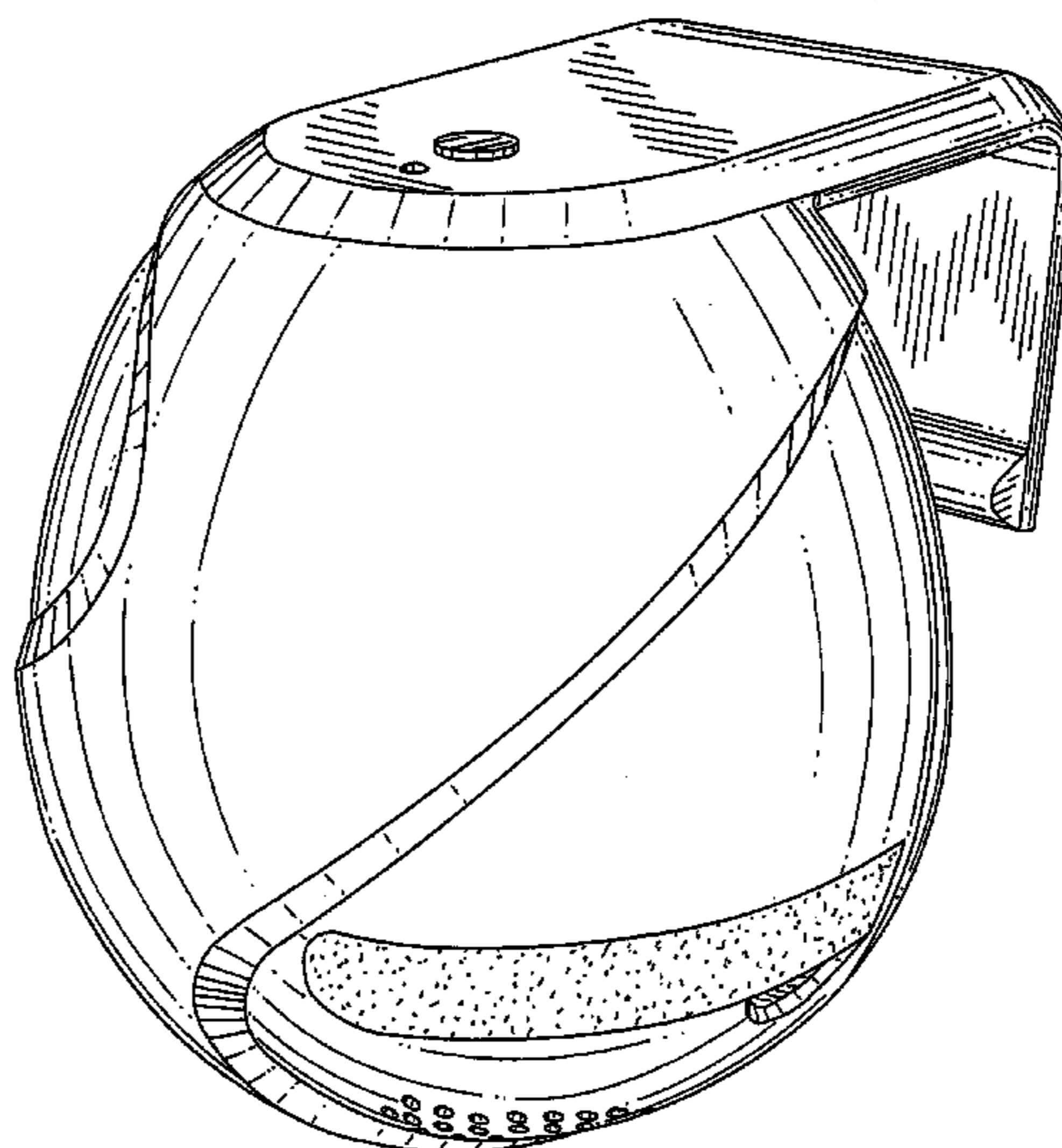

(56)

References Cited

FOREIGN PATENT DOCUMENTS

CN	2403833	11/2000
CN	2642865	9/2004
CN	1566552	1/2005
EP	0289696	11/1988
EP	0748902	12/1996
GB	2272710	11/1992
JP	2009279324	5/2008
KR	20030004949	1/2003
KR	20070011220	1/2007
KR	20100107642	10/2010
KR	2000116370	11/2010
KR	101058923	8/2011
NL	1007447	5/1999

WO	WO9822667	5/1998
WO	WO2004007855	1/2004
WO	WO2004094738	11/2004
WO	WO2005068736	7/2005
WO	WO2007/058931	5/2007
WO	WO2009040788	4/2009

OTHER PUBLICATIONS

Innovative Products, MD, Inc, "Automated Toilet Bowl Deoderizer Steril", Maydealing.com, Aug. 31, 2012.

Allegro Medical Supplies, "Brondell Breeze Deodorizing Toilet Seat", allegro medical.com, Aug. 31, 2012.

Altech Technology Concepts, "Toilet Ventilating and Deoderizing Accessory", patentdata.com, Aug. 31, 2012.

* cited by examiner

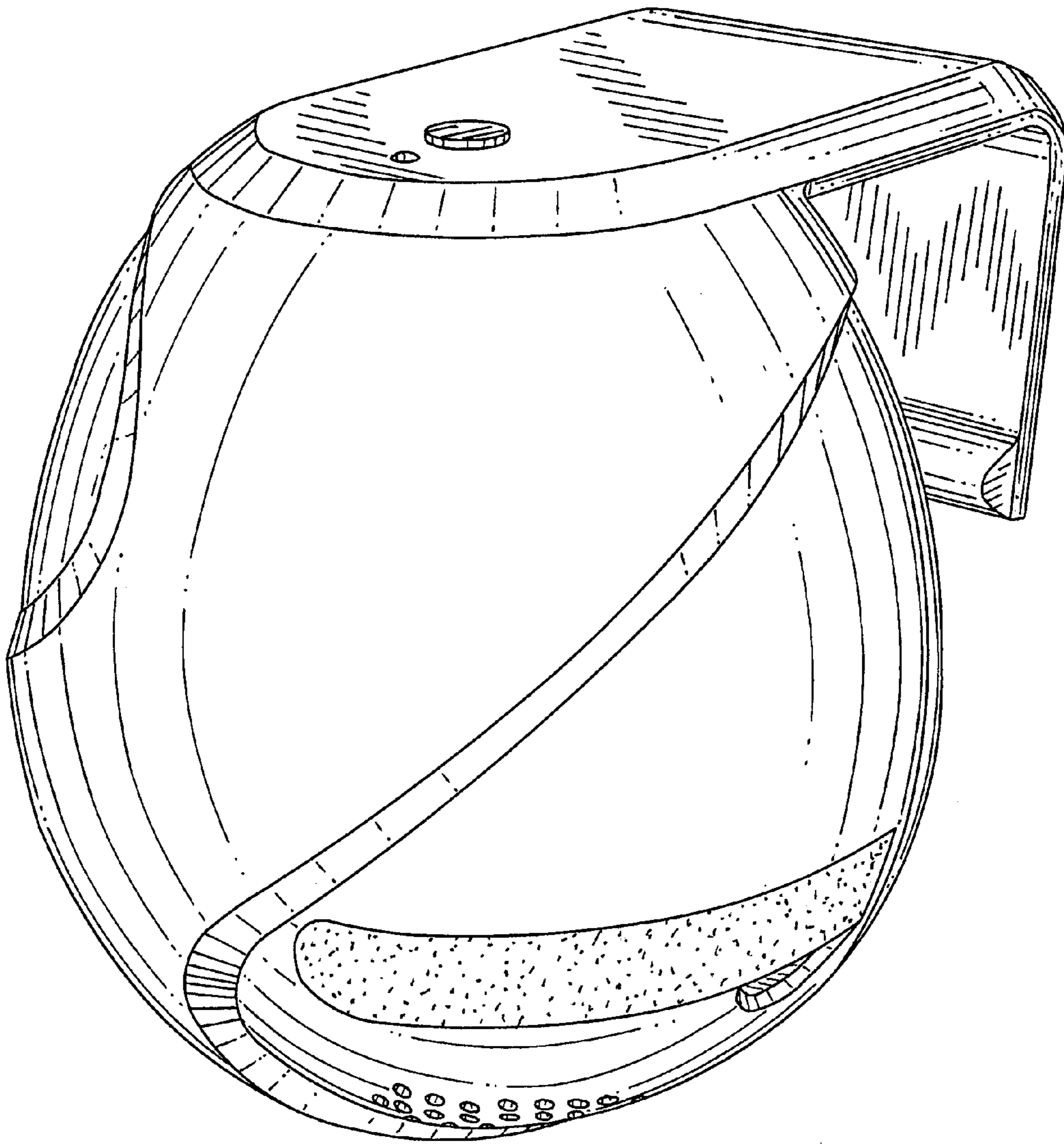

FIG. 1

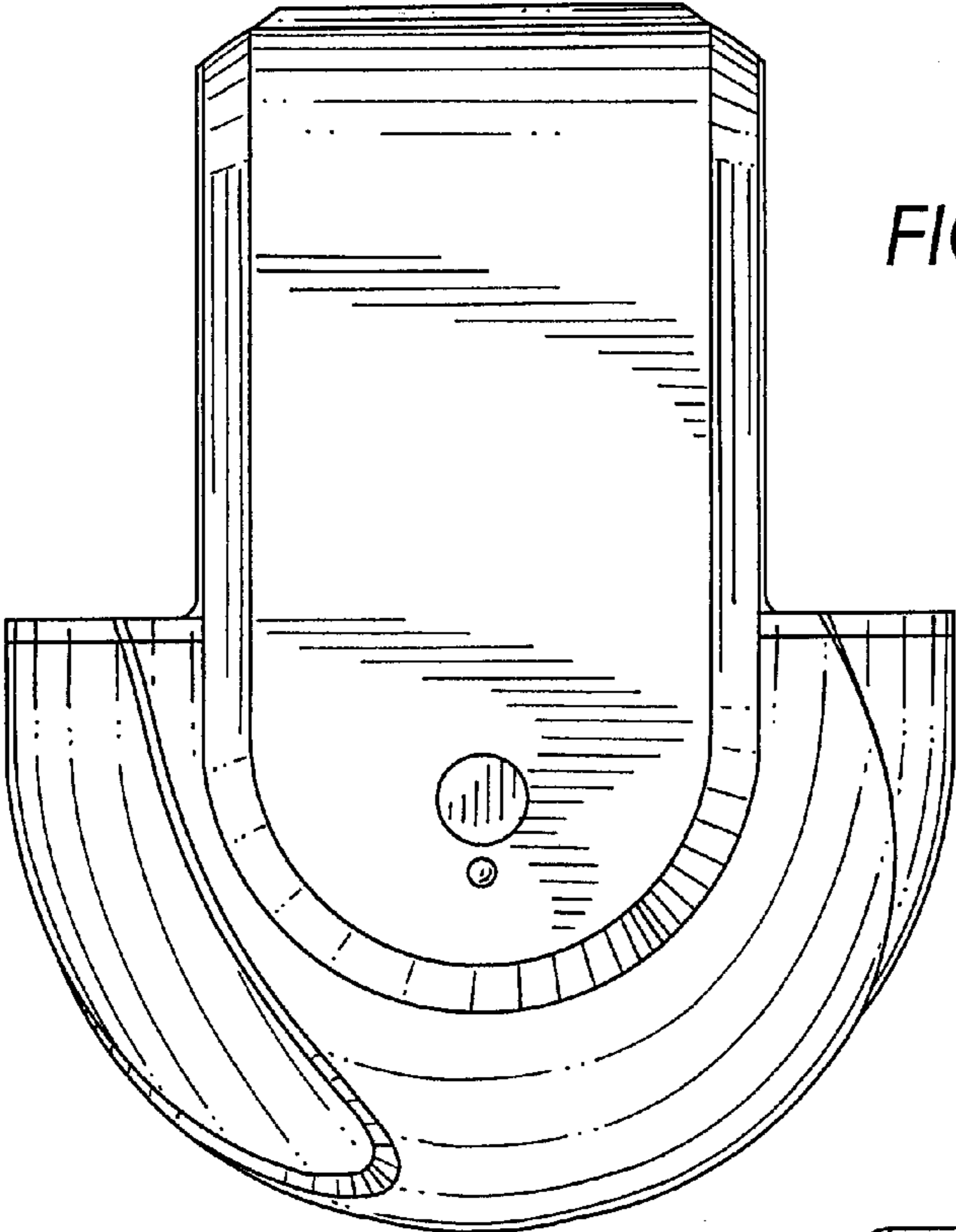

FIG. 2

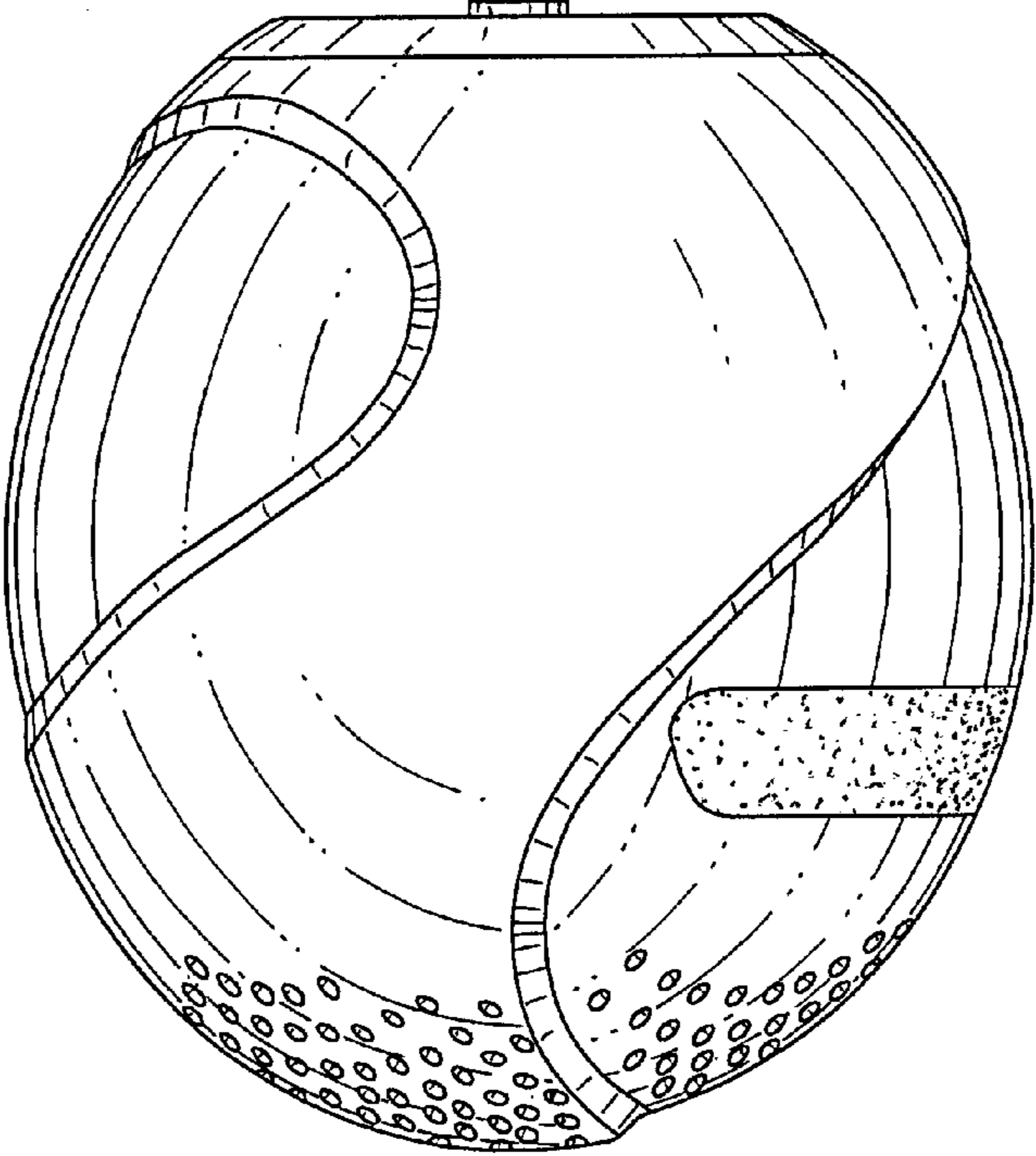

FIG. 3

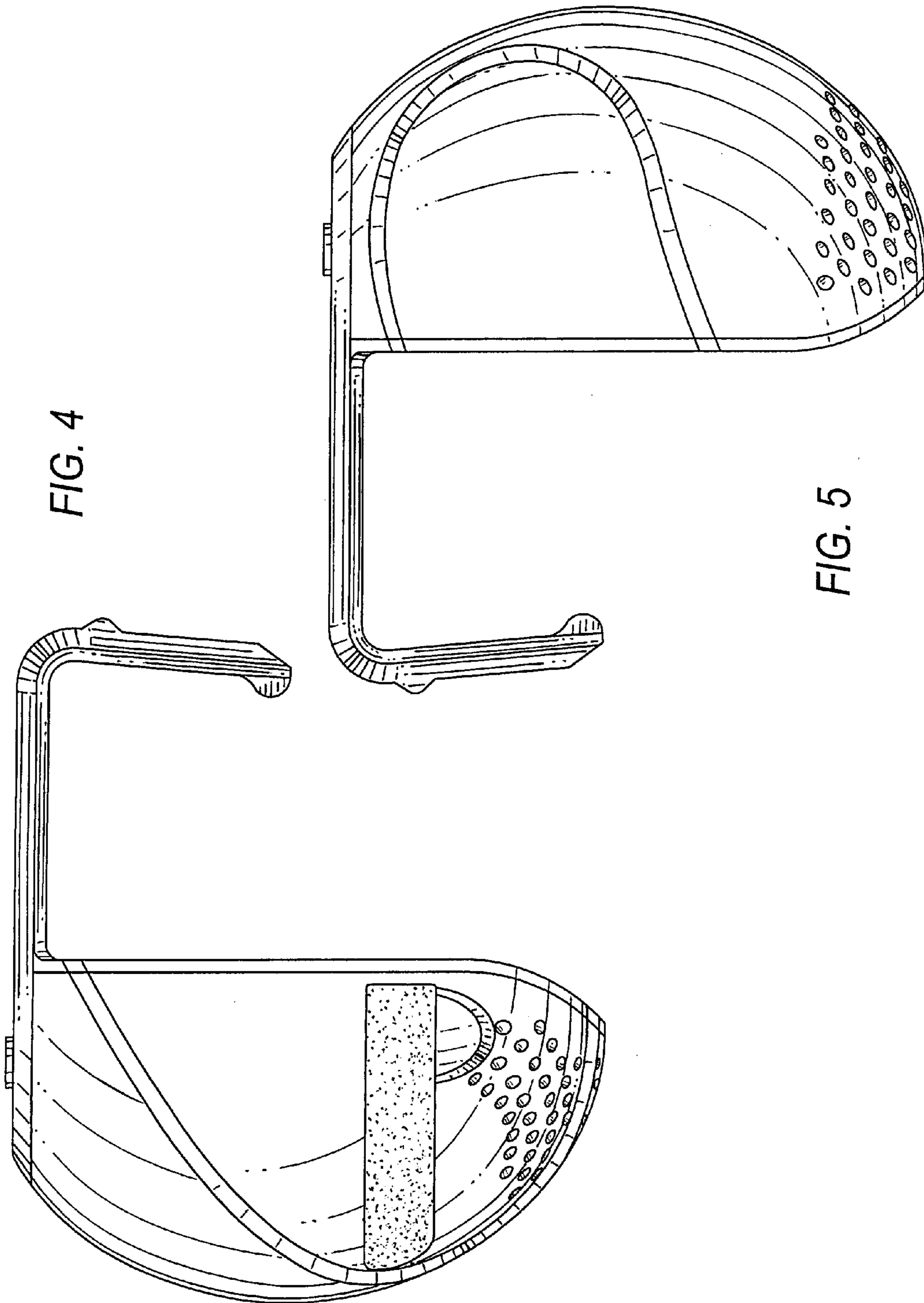

FIG. 4

FIG. 5

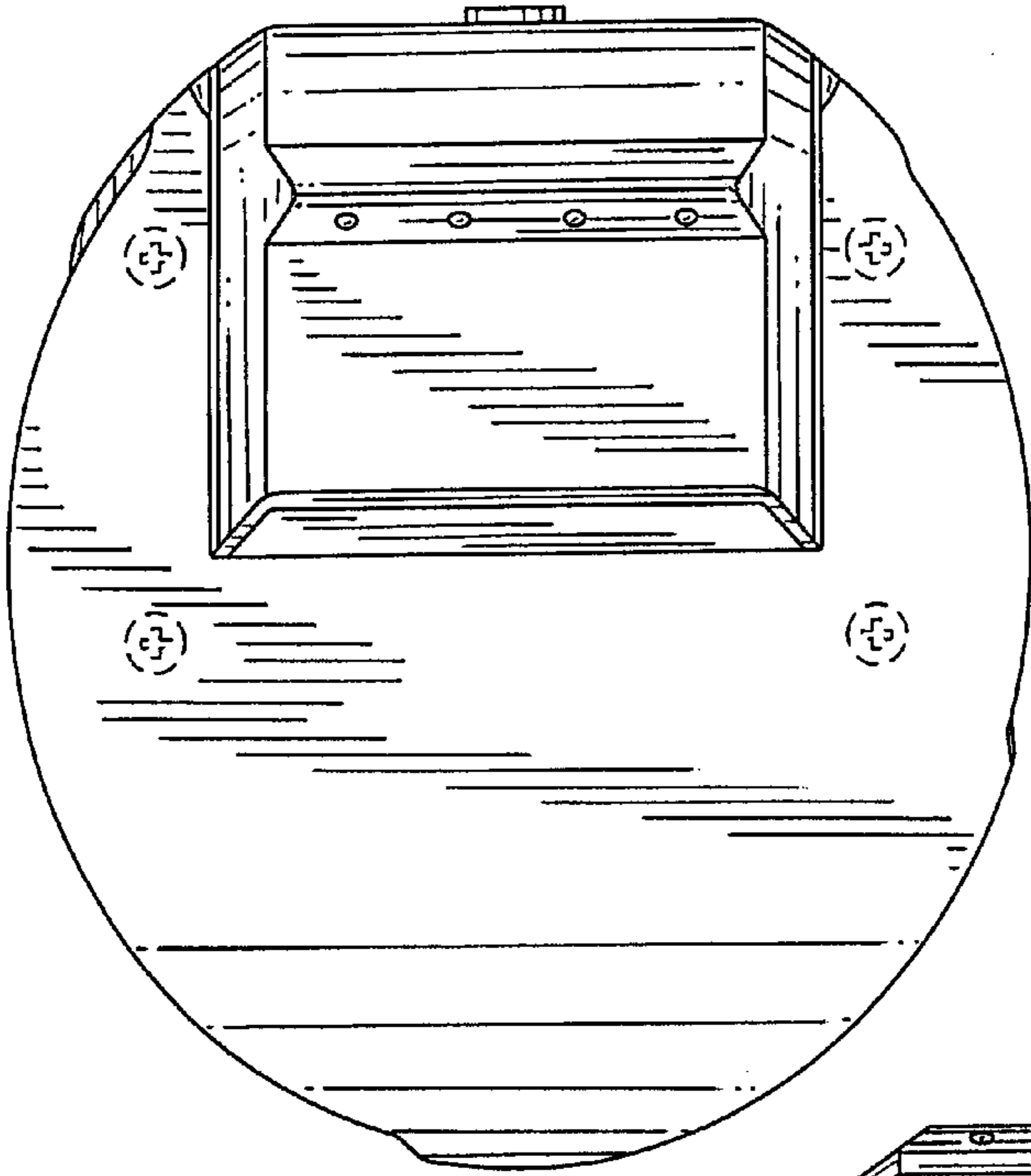

FIG. 6

FIG. 7

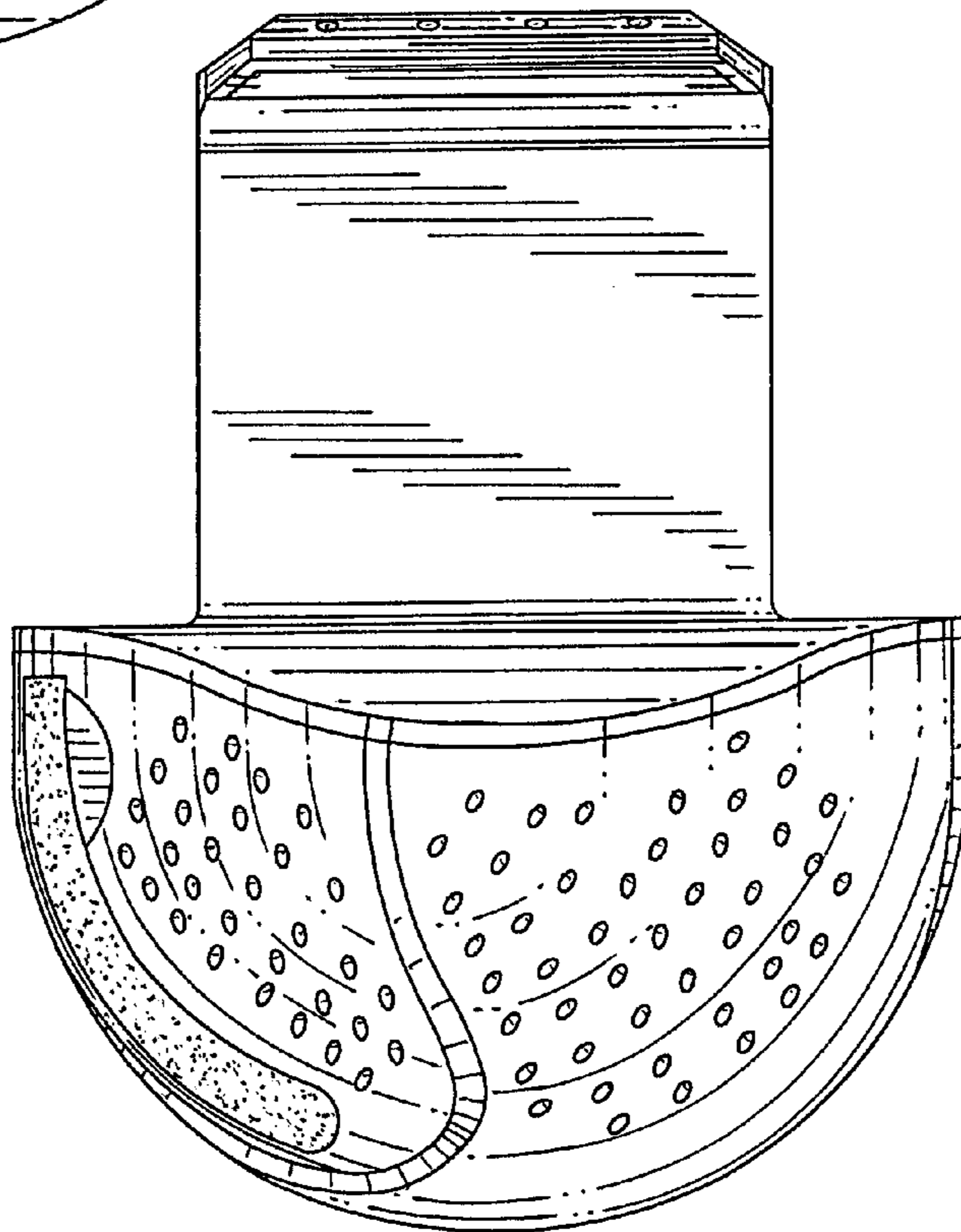

FIG. 8

