



US00D692861S

(12) **United States Design Patent**
Paterson

(10) **Patent No.:** **US D692,861 S**

(45) **Date of Patent:** **** Nov. 5, 2013**

(54) **SPEAKER**

(75) Inventor: **Michael Edward James Paterson,**
Wanchai (HK)

(73) Assignee: **Koninklijke Philips N.V.,** Eindhoven
(NL)

(**) Term: **14 Years**

(21) Appl. No.: **29/426,727**

(22) Filed: **Jul. 10, 2012**

(30) **Foreign Application Priority Data**

Jan. 10, 2012 (EM) 001973397-0002

Jan. 30, 2012 (EM) 001983107-0002

(51) **LOC (9) Cl.** **14-03**

(52) **U.S. Cl.**
USPC **D14/214**

(58) **Field of Classification Search**
USPC D14/167, 172, 194–196, 204, 207,
D14/209.1, 210–216, 221, 222; 181/143,
181/144, 147, 148, 150, 153, 157, 198,
181/199; 381/300–303, 306, 332, 333, 336,
381/345, 361–364, 386–388

See application file for complete search history.

(56) **References Cited**

U.S. PATENT DOCUMENTS

D372,917 S *	8/1996	Kobayashi	D14/214
D535,976 S *	1/2007	Ng et al.	D14/214
D548,224 S *	8/2007	Taylor	D14/216
D606,962 S *	12/2009	Wada	D14/149
D641,338 S *	7/2011	Chen	D14/209.1
D661,687 S *	6/2012	Yoshiizumi	D14/214
D662,081 S *	6/2012	Yoshiizumi	D14/214
D670,271 S *	11/2012	Tzeng	D14/216
D672,334 S *	12/2012	Tzeng	D14/212
D676,418 S *	2/2013	Suzuki	D14/209.1
D677,244 S *	3/2013	Funayama	D14/209.1
D678,244 S *	3/2013	Behar et al.	D14/214
D681,604 S *	5/2013	Funayama	D14/209.1

* cited by examiner

Primary Examiner — Keli L Hill

(57) **CLAIM**

The ornamental design for a speaker, as shown and described.

DESCRIPTION

FIG. 1 is a perspective view showing my design;
FIG. 2 is a front elevational view thereof;
FIG. 3 is a rear elevational view thereof;
FIG. 4 is a right side elevational view thereof;
FIG. 5 is a left side elevational view thereof;
FIG. 6 is a top plan view thereof; and,
FIG. 7 is a bottom plan view thereof.
The broken lines shown are included for the purpose of illustrating portions of the speaker that form no part of the claim.

1 Claim, 4 Drawing Sheets

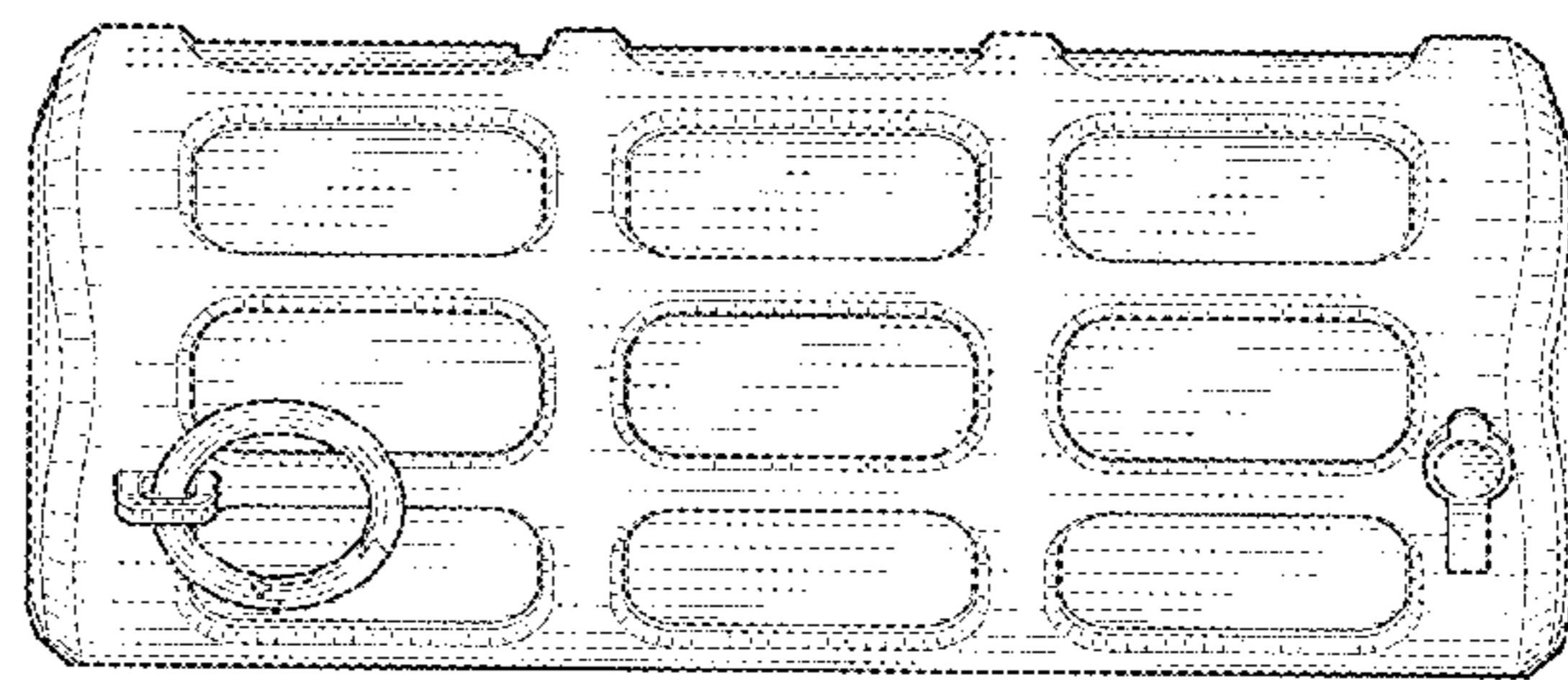
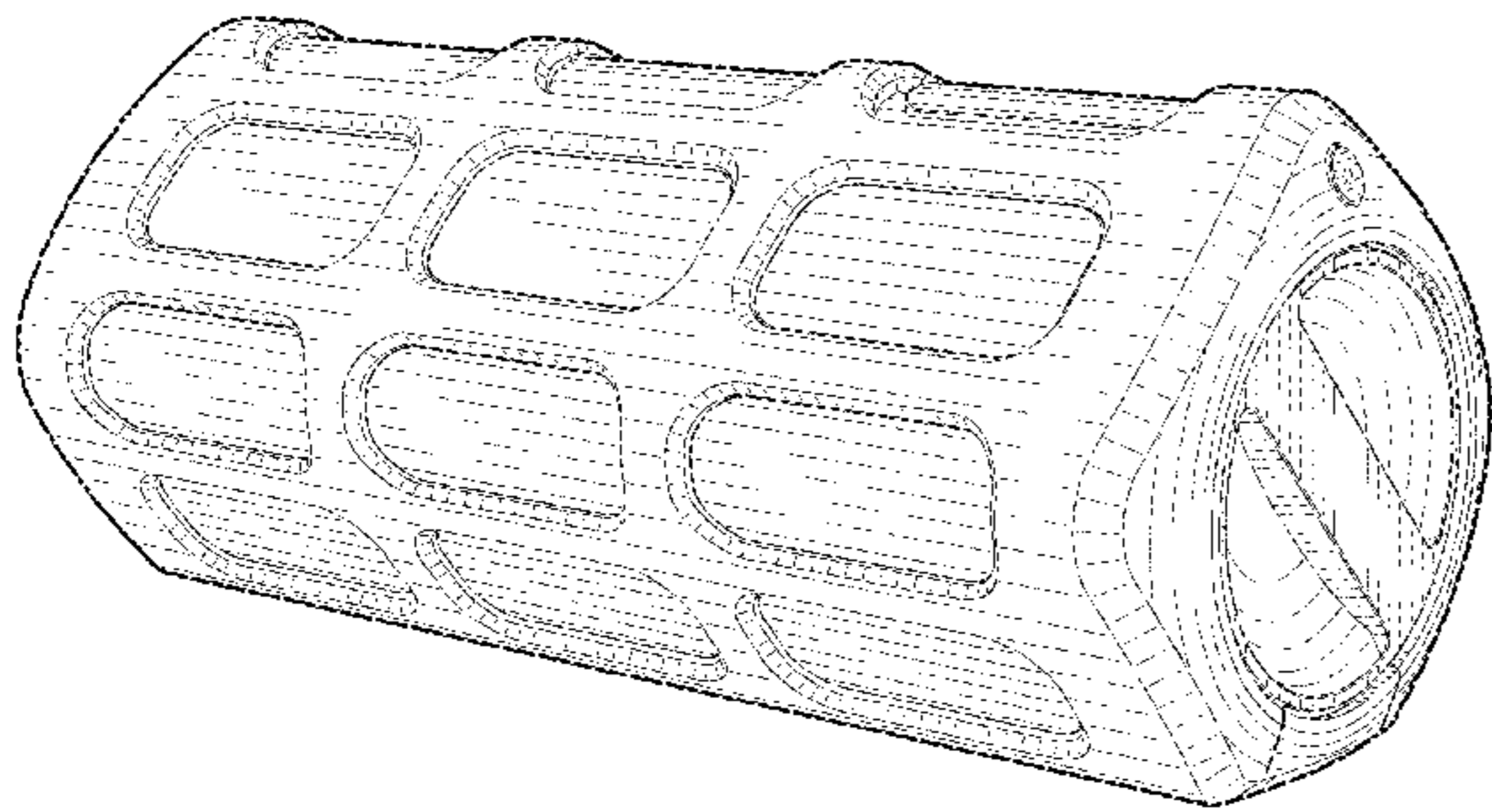

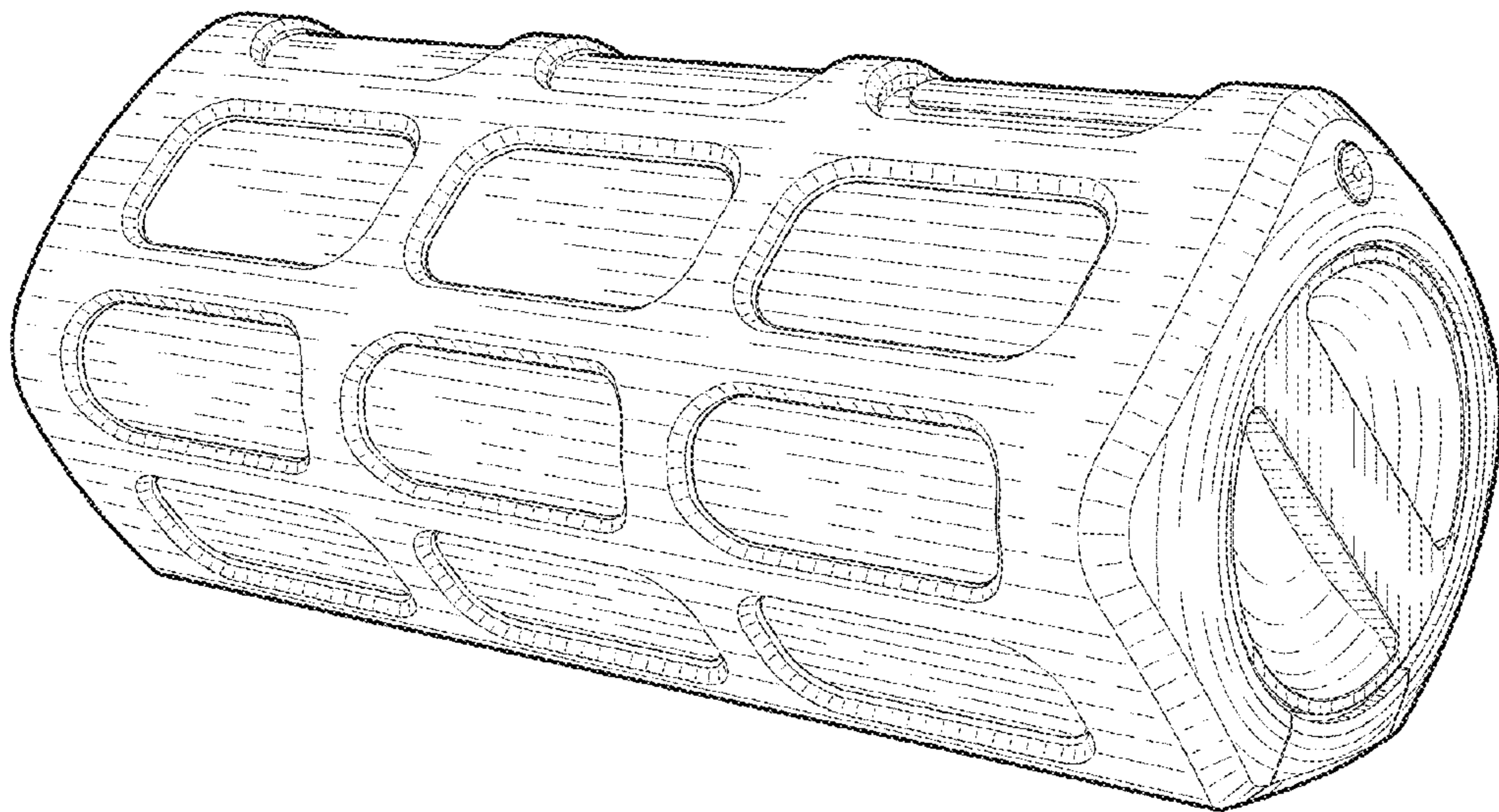

FIG. 1

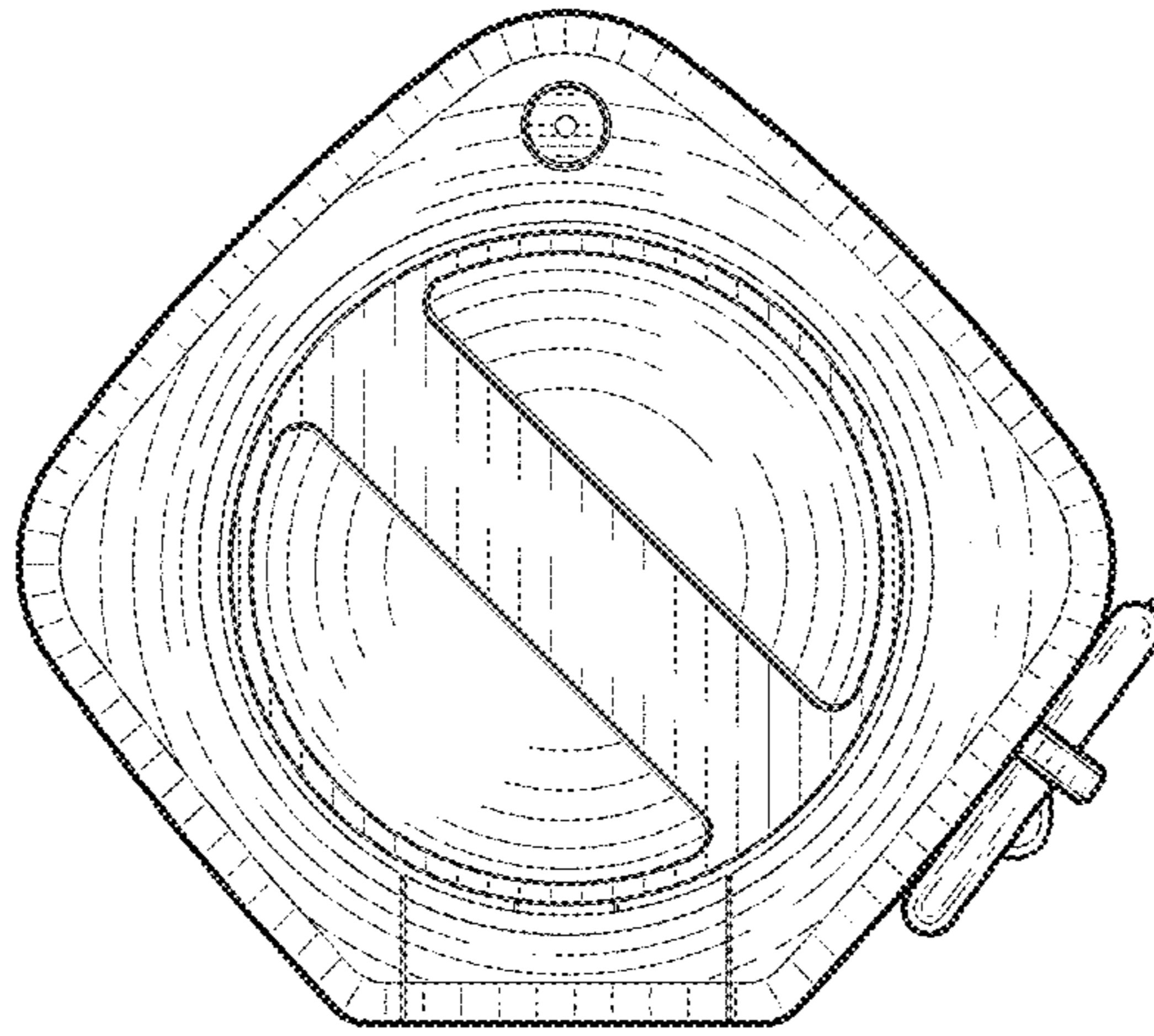

FIG. 2

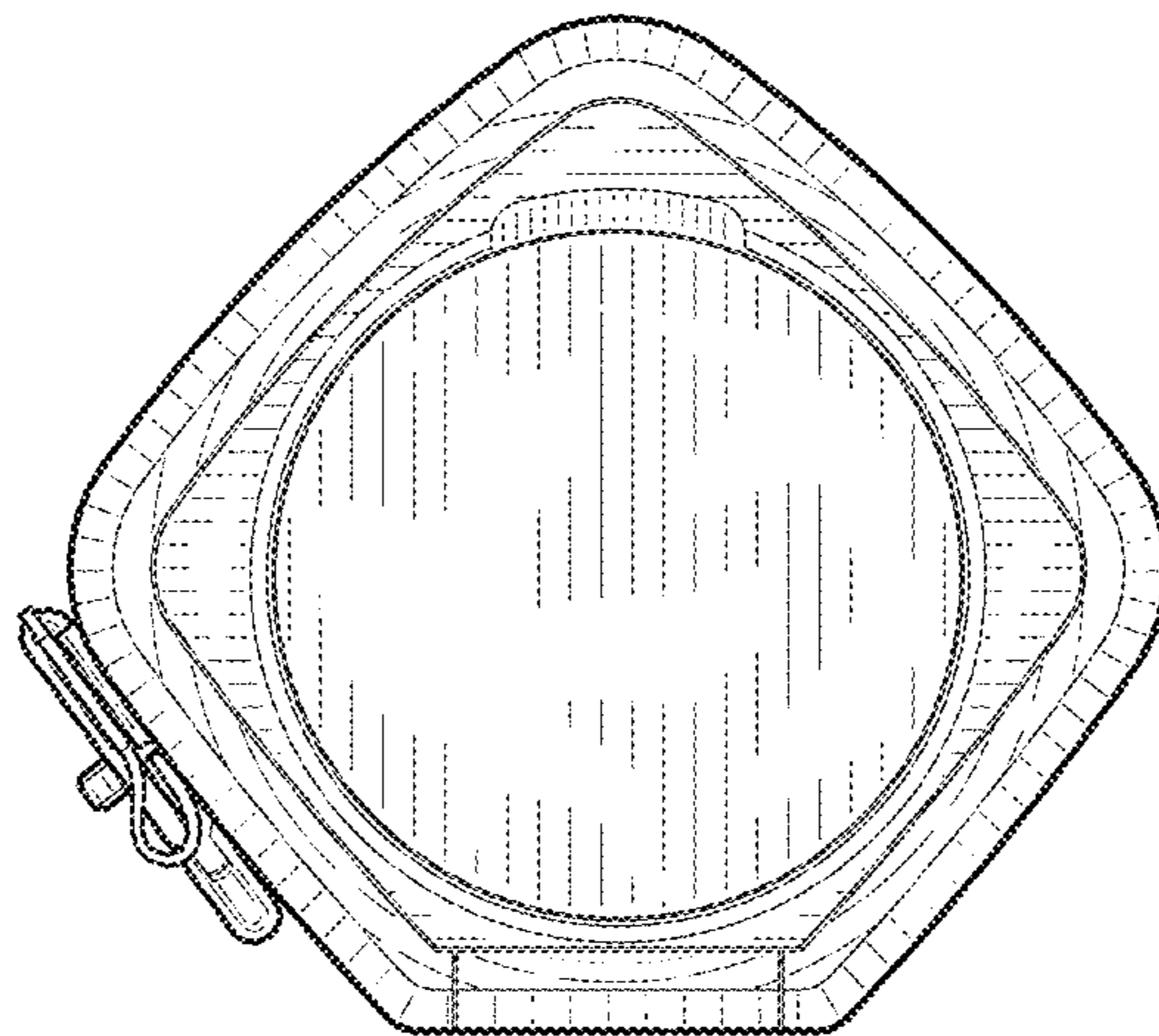

FIG. 3

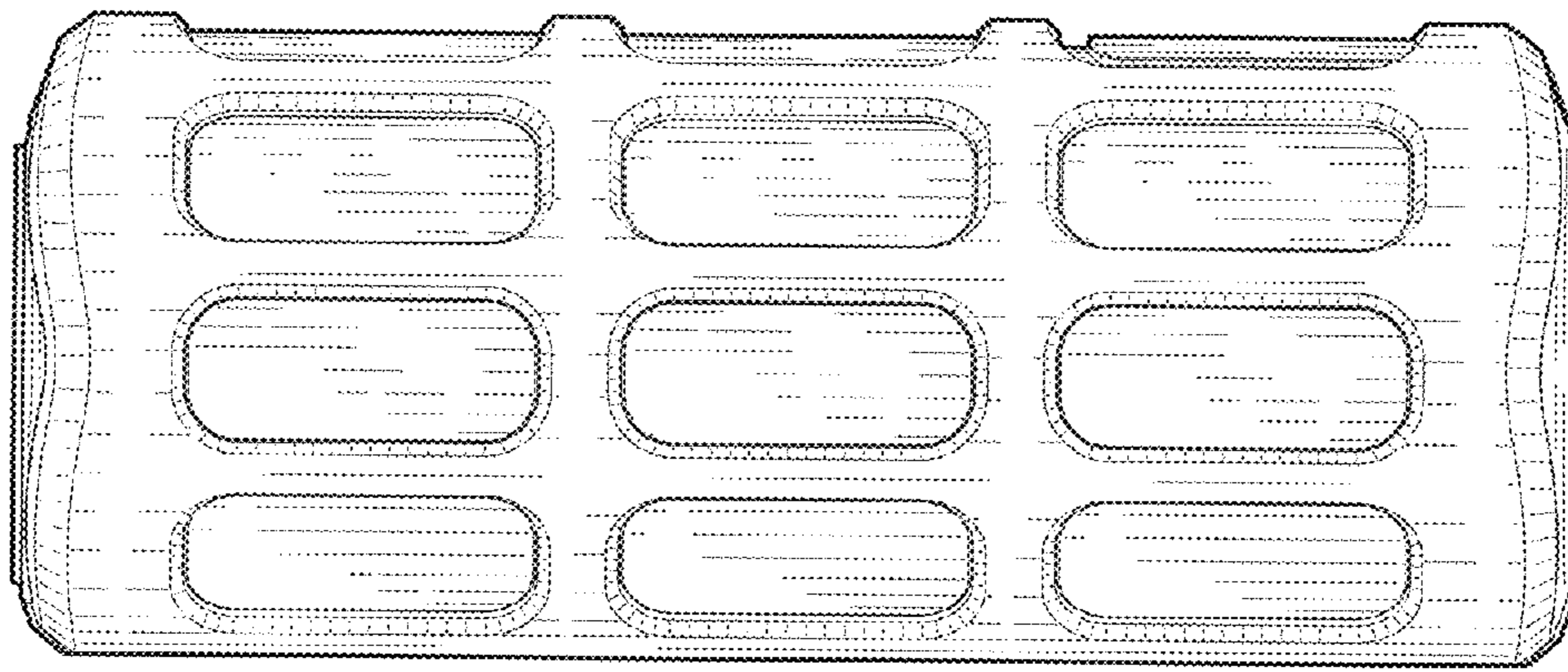

FIG. 4

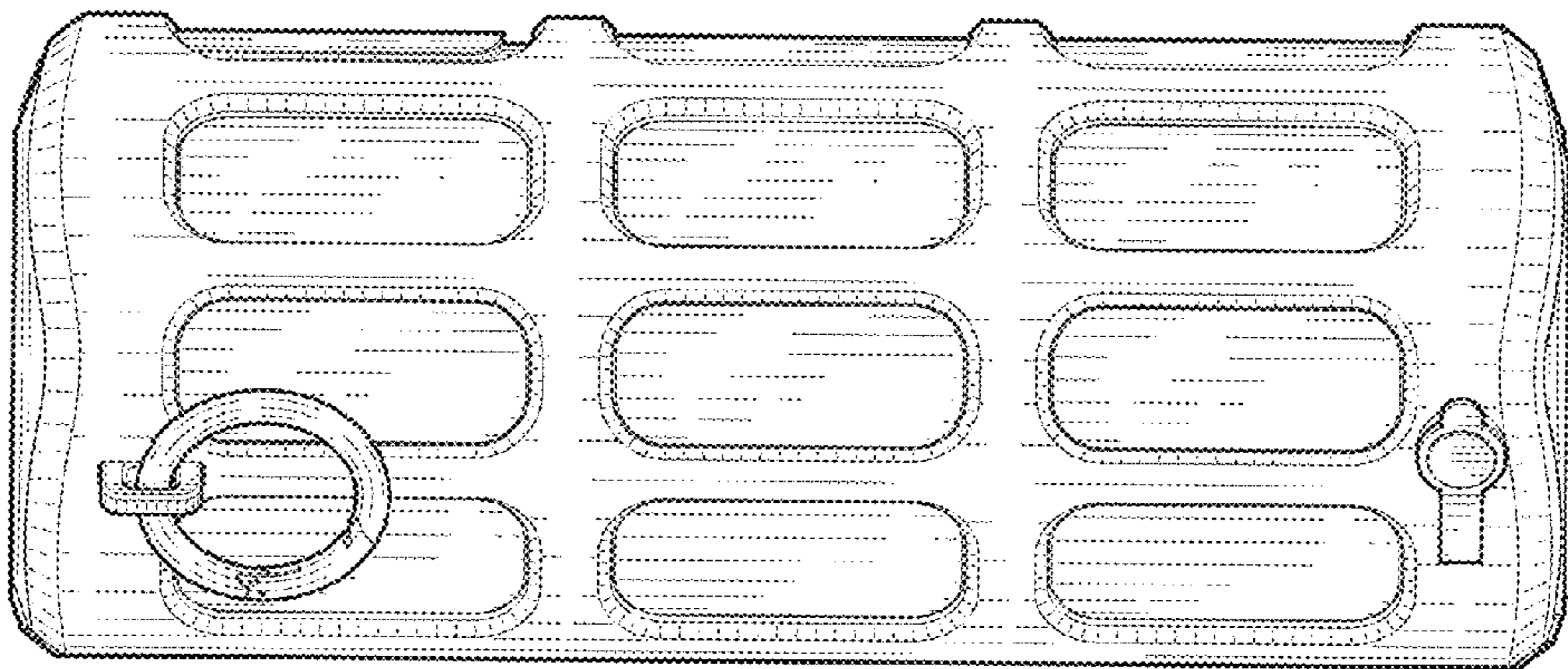

FIG. 5

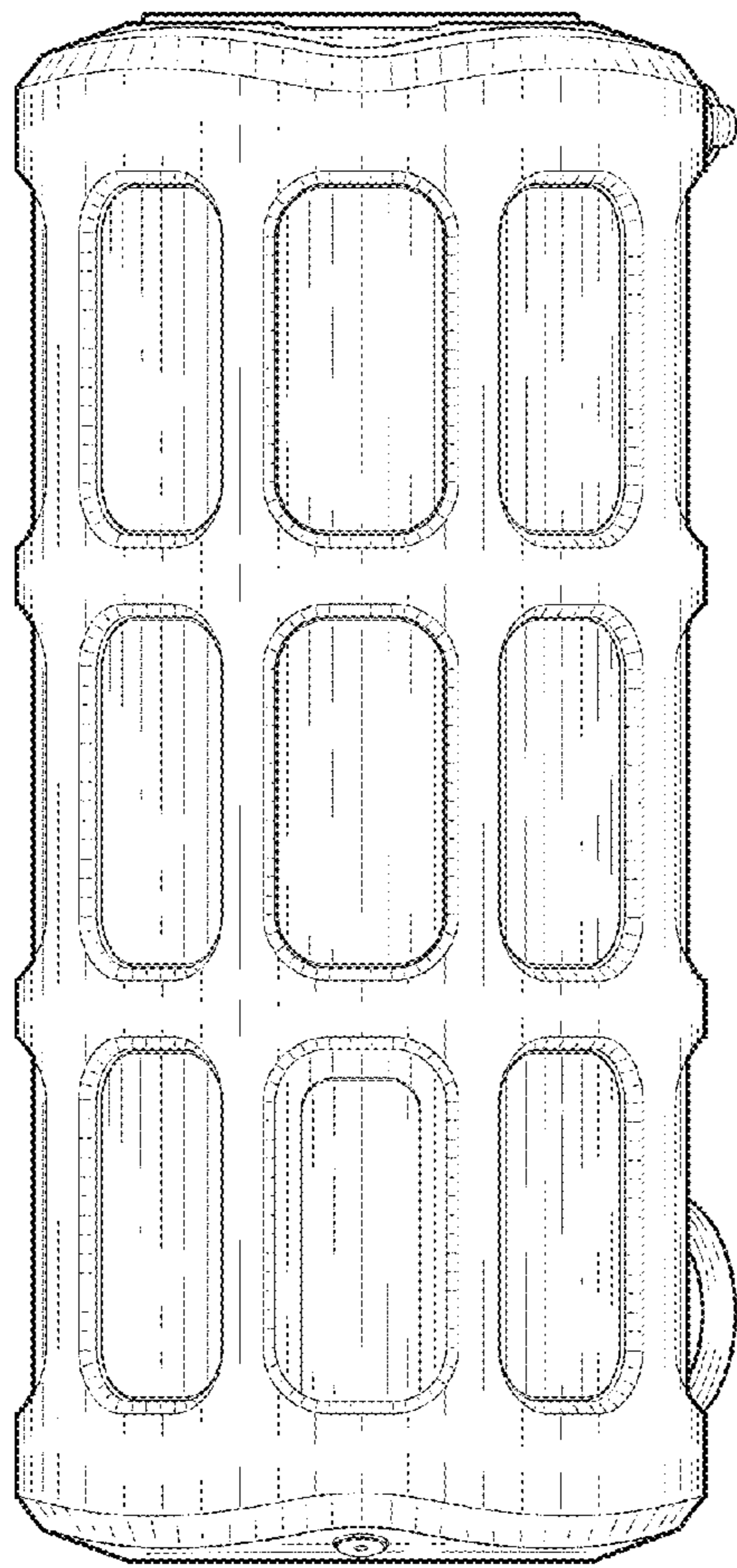

FIG. 6

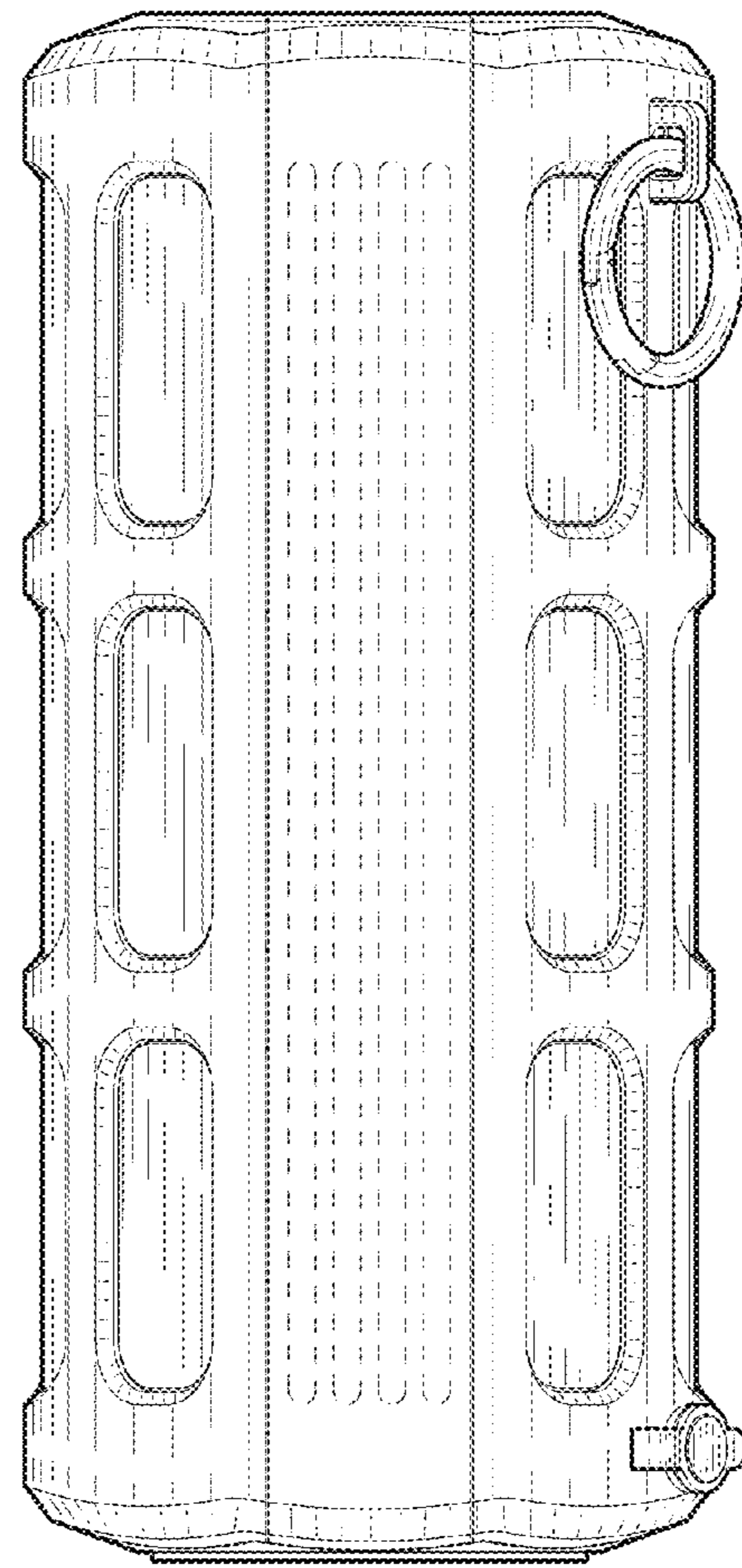

FIG. 7