



US00D692788S

(12) **United States Design Patent**
Silverman et al.

(10) **Patent No.:** **US D692,788 S**

(45) **Date of Patent:** **** Nov. 5, 2013**

(54) **CALIBRATION STATION**

604/503, 65, 66, 67, 182; 702/19, 40;
221/65, 135; 235/451, 422.01; 95/87;
96/101, 106; 366/286, 207

(71) Applicant: **Lifeloc Technologies, Inc.**, Wheat
Ridge, CO (US)

See application file for complete search history.

(72) Inventors: **Kelly Silverman**, Denver, CO (US);
Mark Lary, Littleton, CO (US);
Christina Wamsley, Idaho Springs, CO
(US); **Gurumurthi Ravishankar**,
Englewood, CO (US); **Brandon**
Wellborn, Arvada, CO (US)

(56) **References Cited**

U.S. PATENT DOCUMENTS

D677,184 S * 3/2013 Kluser et al. D10/78

* cited by examiner

(73) Assignee: **Lifeloc Technologies, Inc.**, Wheat
Ridge, CO (US)

Primary Examiner — Antoine D Davis

(74) *Attorney, Agent, or Firm* — HolzerIPLaw, PC

(**) Term: **14 Years**

(57) **CLAIM**

We claim the ornamental design for a calibration station, as
shown and described.

(21) Appl. No.: **29/444,555**

DESCRIPTION

(22) Filed: **Jan. 31, 2013**

(51) **LOC (9) Cl.** **10-04**

(52) **U.S. Cl.**

USPC **D10/81; D10/78**

(58) **Field of Classification Search**

USPC D10/75, 78, 81; D24/216, 232–234;
73/1.01, 1.02–1.08, 1.16, 19.01–19.02,
73/23.2–23.27, 23.3, 23.35–24.01, 52,
73/53.01, 61.52–61.61, 864.21, 431,
73/864.73, 31.03, 31.05, 866.5, 864.84,
73/864.23, 61.55, 863.01, 866; 204/253,
204/400, 403.01, 403.02, 403.04, 403.05,
204/403.1, 403.11, 403.14; 205/775, 777.5,
205/778, 792; 210/656–660, 198.2, 635,
210/101, 103; 250/252.1, 251, 25, 266,
250/281–300, 305, 336.1, 338.1, 338.5,
250/339.07, 339.13, 343, 349, 239, 910;
356/446, 246, 301–337, 451, 72, 73;
422/50–53, 62–82, 83–98, 239.2, 400,
422/401, 404; 435/4, 283.1–284.1, 286.5,
435/287.1, 287.2, 806, 13, 14, 287.4, 287.7,
435/287.94, 6.18; 436/43–54, 68, 900, 514,
436/530, 95; 600/300, 301, 309, 322, 345,
600/347, 365, 393, 578, 583, 584; 604/207,

FIG. 1 is a first perspective view of a calibration station
according to our new design.

FIG. 2 is a second perspective view thereof with a mouthpiece
attached thereto.

FIG. 3 is a third perspective view thereof with a breath alcohol
content analyzer and a calibration gas tank attached thereto.

FIG. 4 is a fourth perspective view thereof.

FIG. 5 is a top plan view thereof.

FIG. 6 is a top plan view thereof with a mouthpiece attached
thereto.

FIG. 7 is a bottom plan view thereof.

FIG. 8 is a front elevation view thereof.

FIG. 9 is a front elevation view thereof with a mouthpiece
attached thereto.

FIG. 10 is a rear elevation view thereof

FIG. 11 is a right-side elevation view thereof; and,

FIG. 12 is a left-side elevation view thereof.

The broken lines shown in each of FIGS. 2, 3, 6, and 9 depict
one or more of a breath alcohol content analyzer, a calibration
gas tank, and a mouthpiece, all of which form no part of the
claimed design.

1 Claim, 12 Drawing Sheets

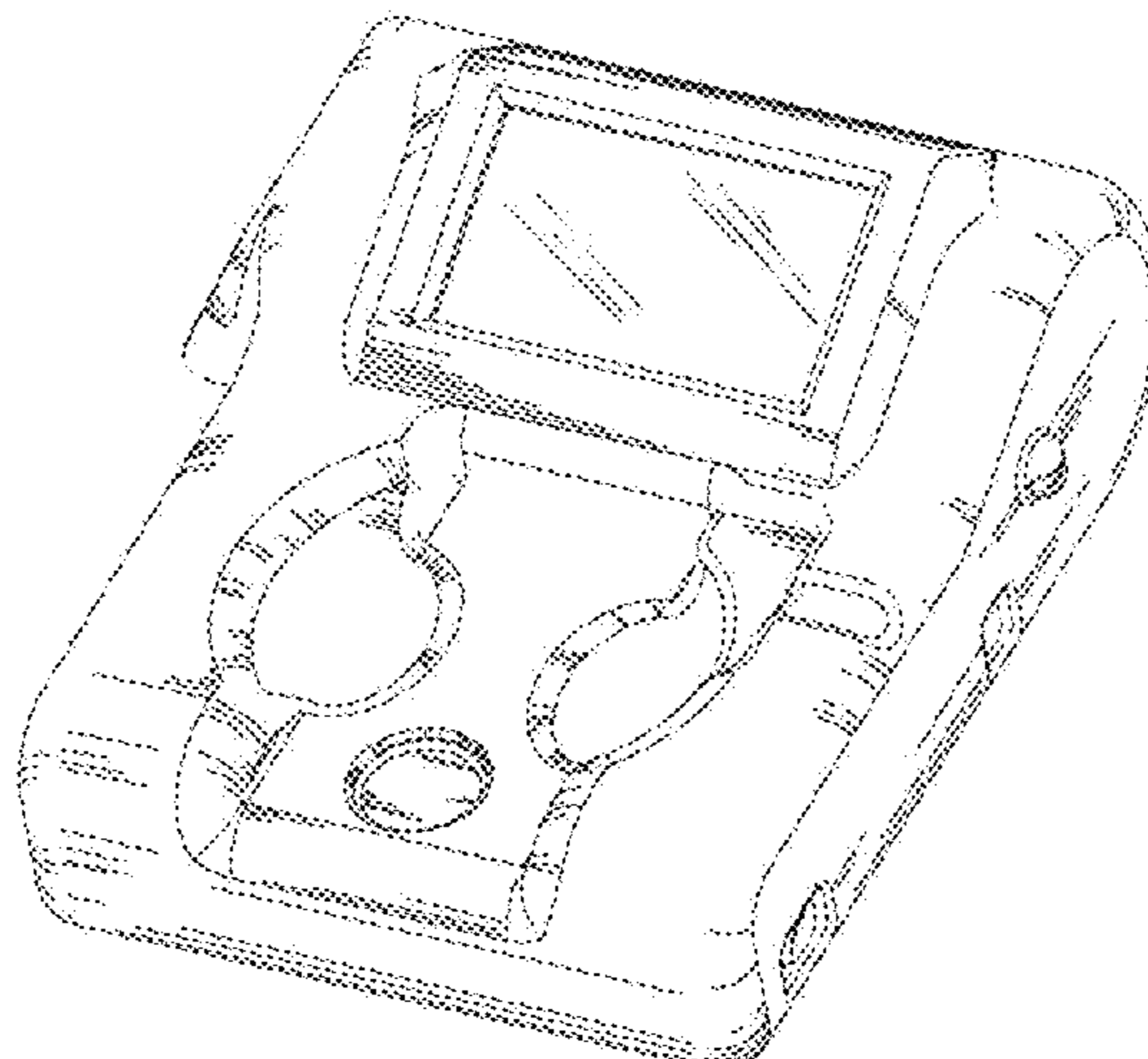

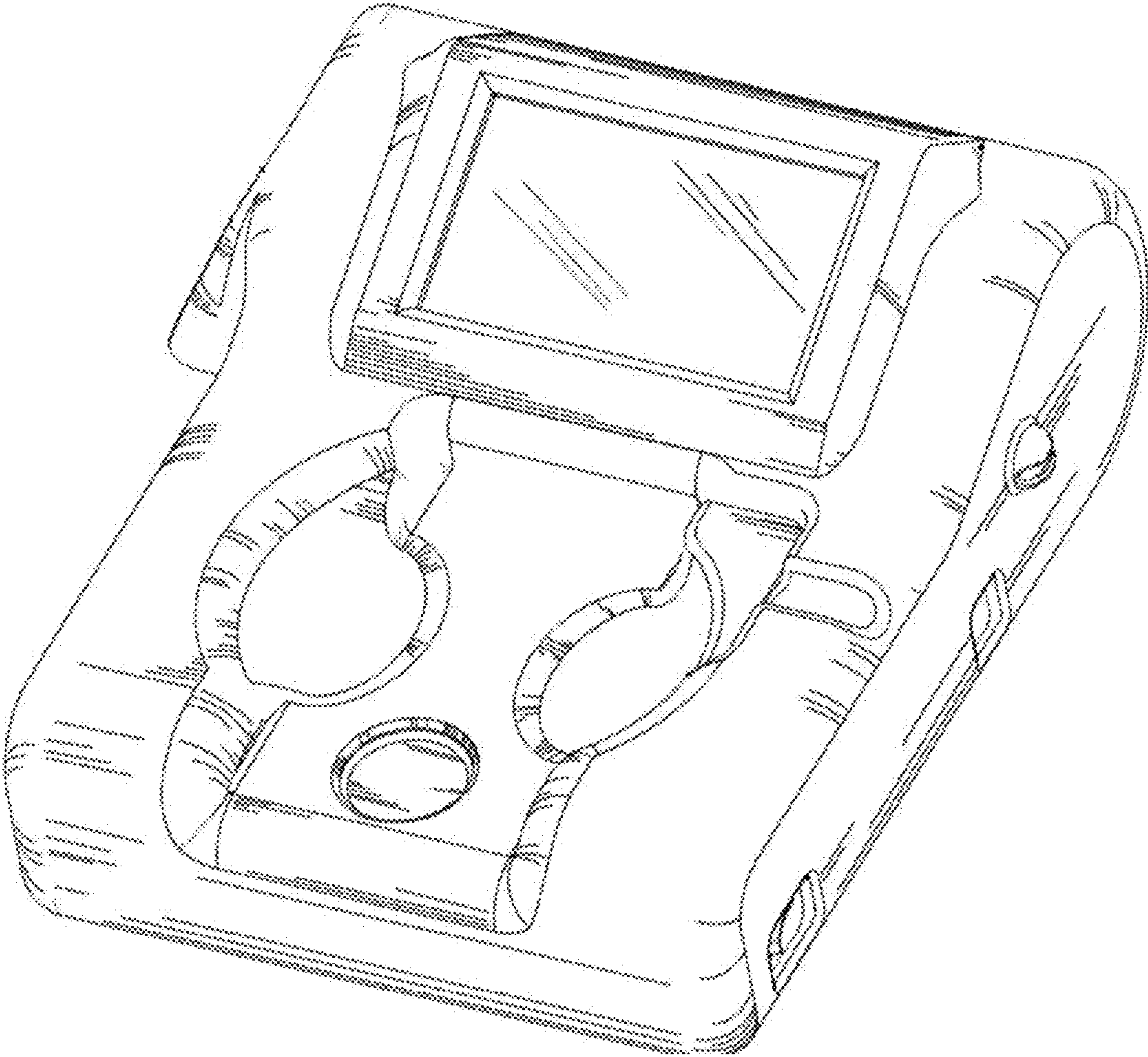

FIG. 1

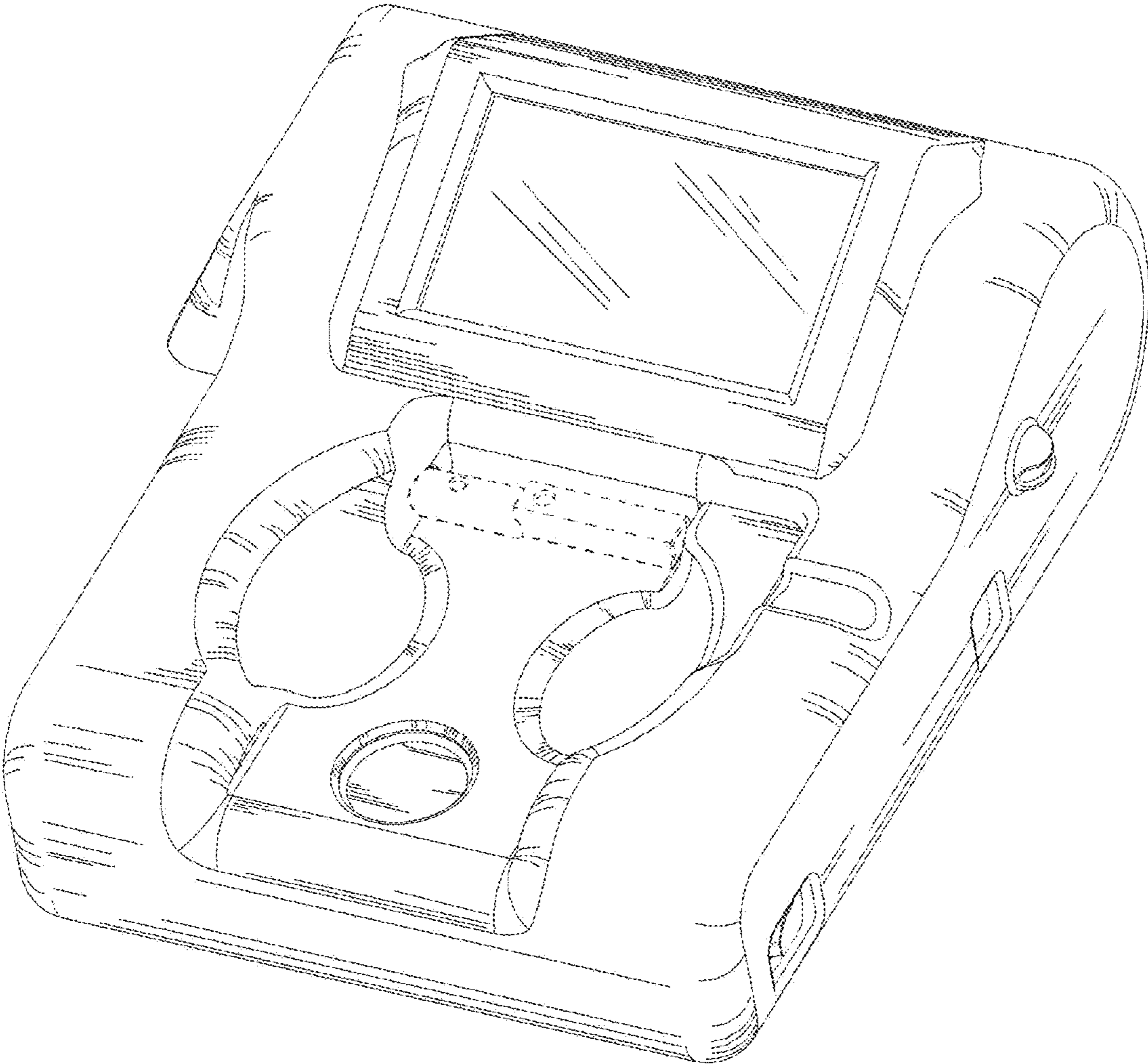

FIG. 2

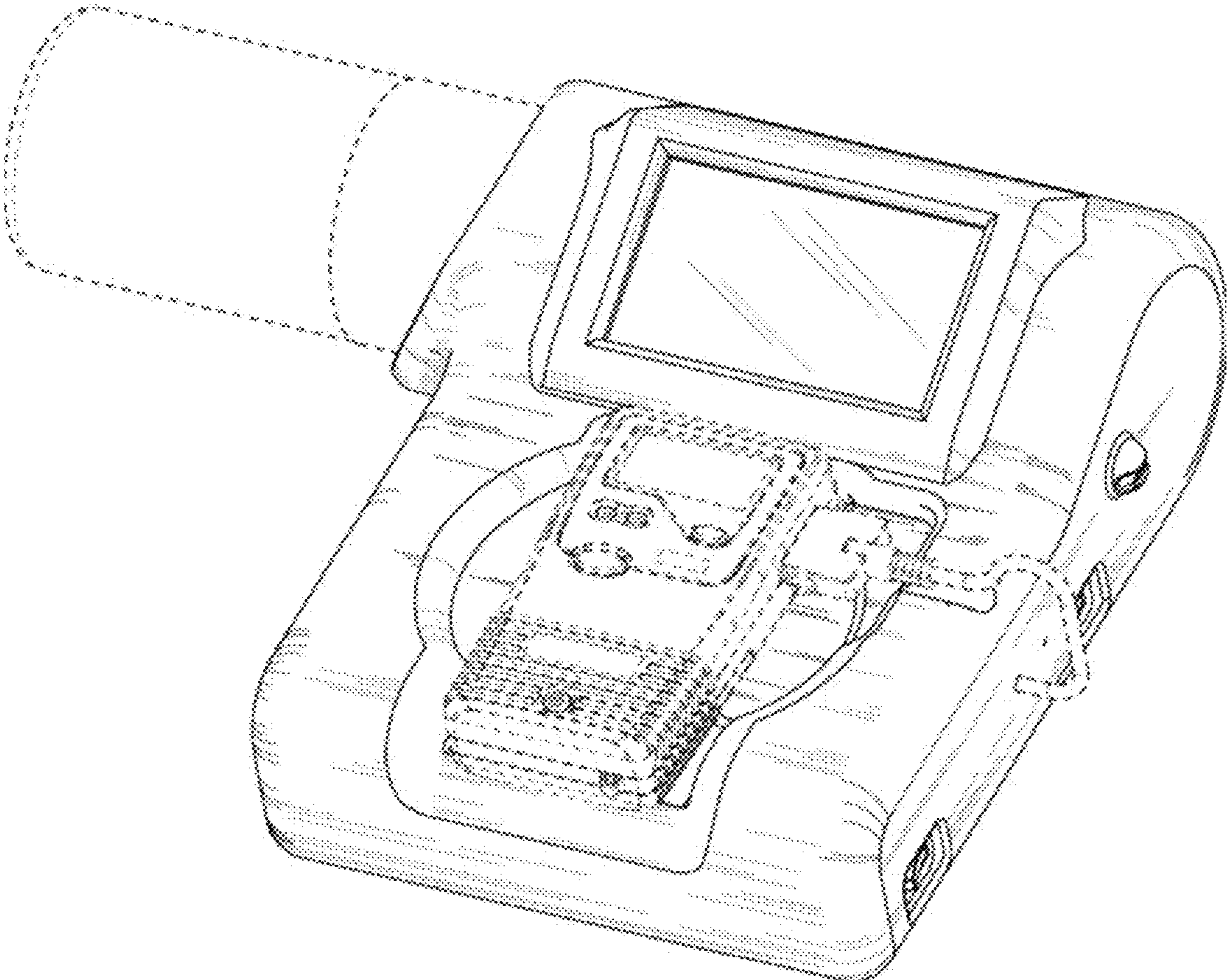

FIG. 3

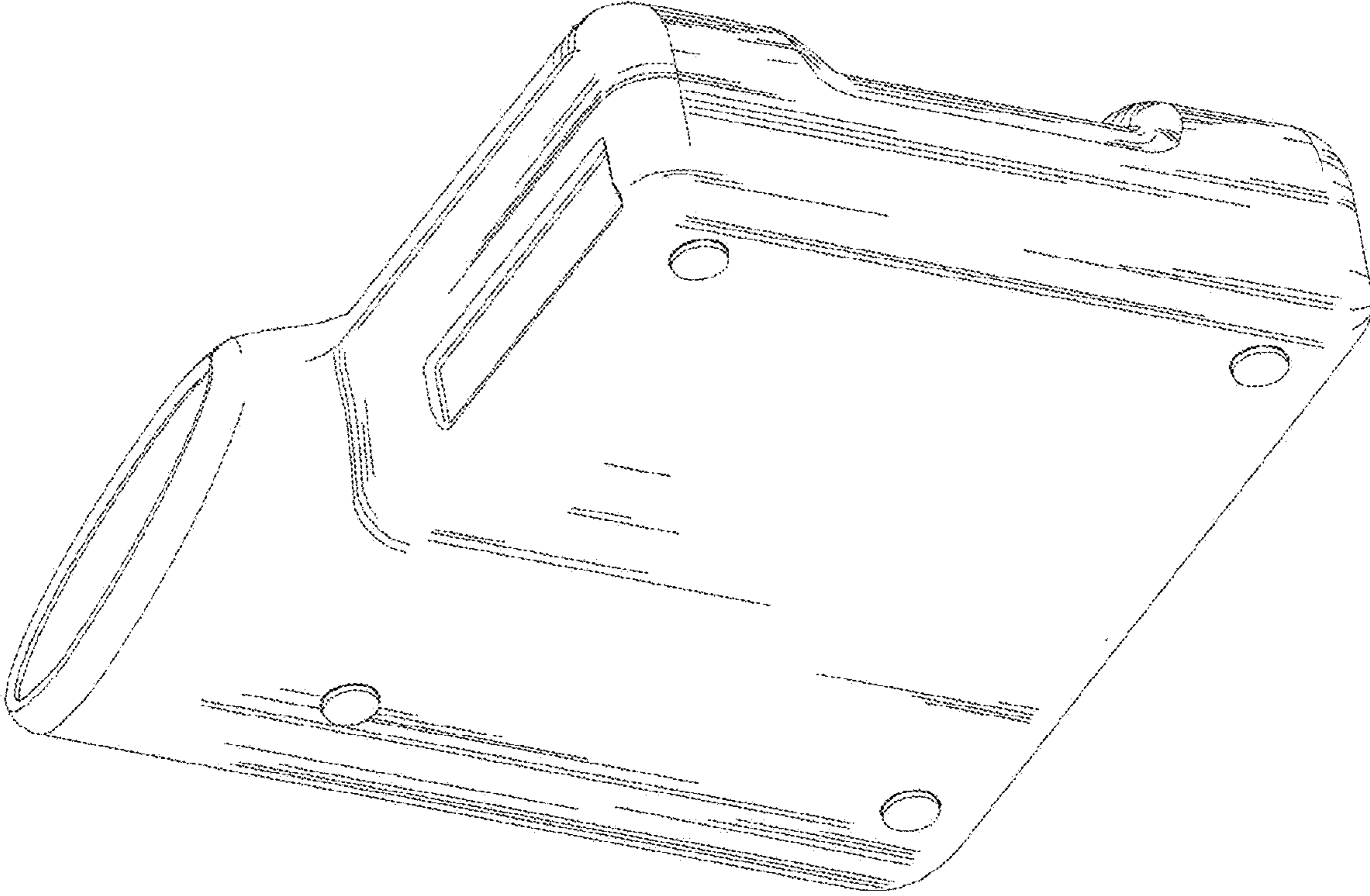

FIG. 4

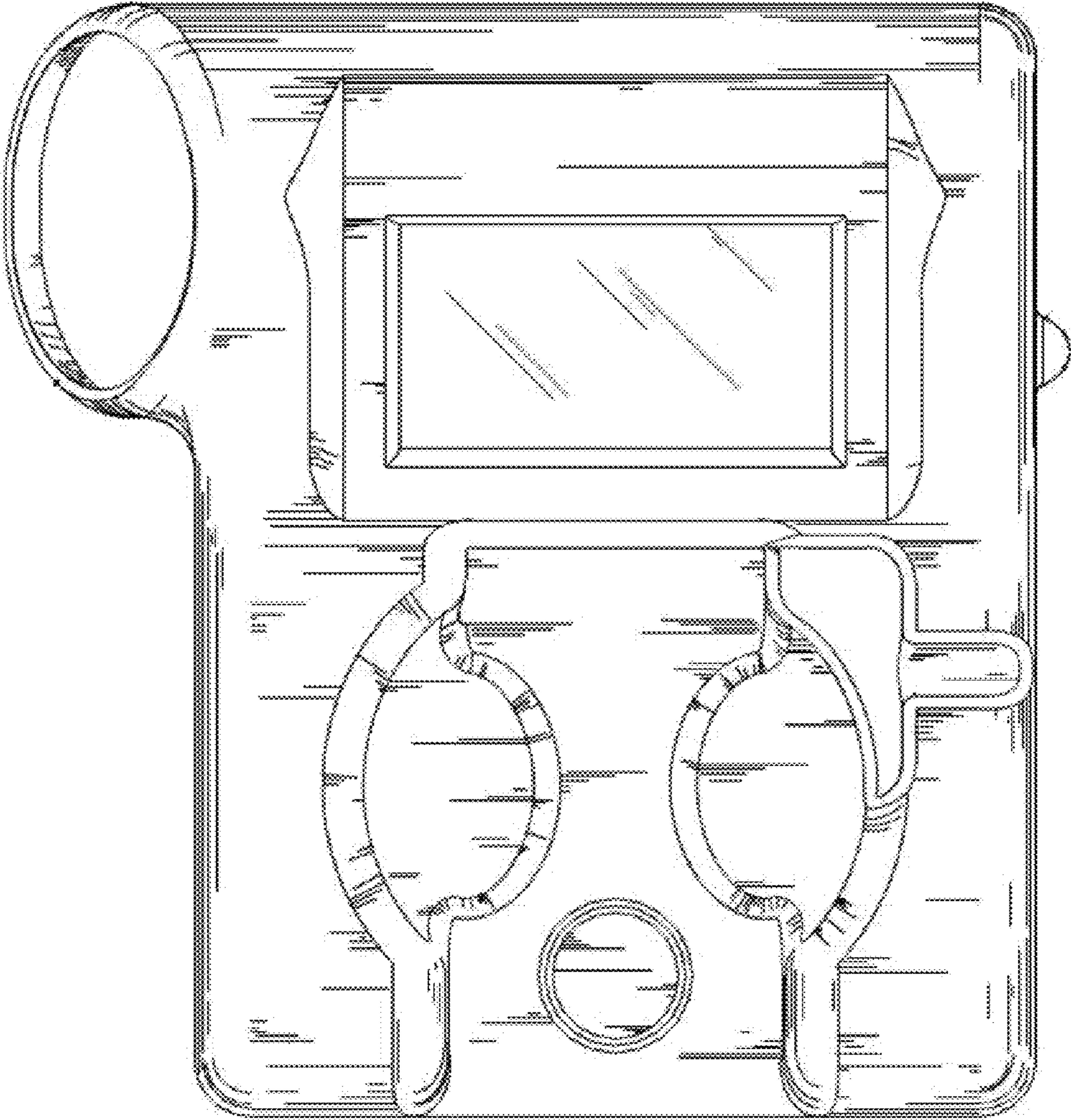

FIG. 5

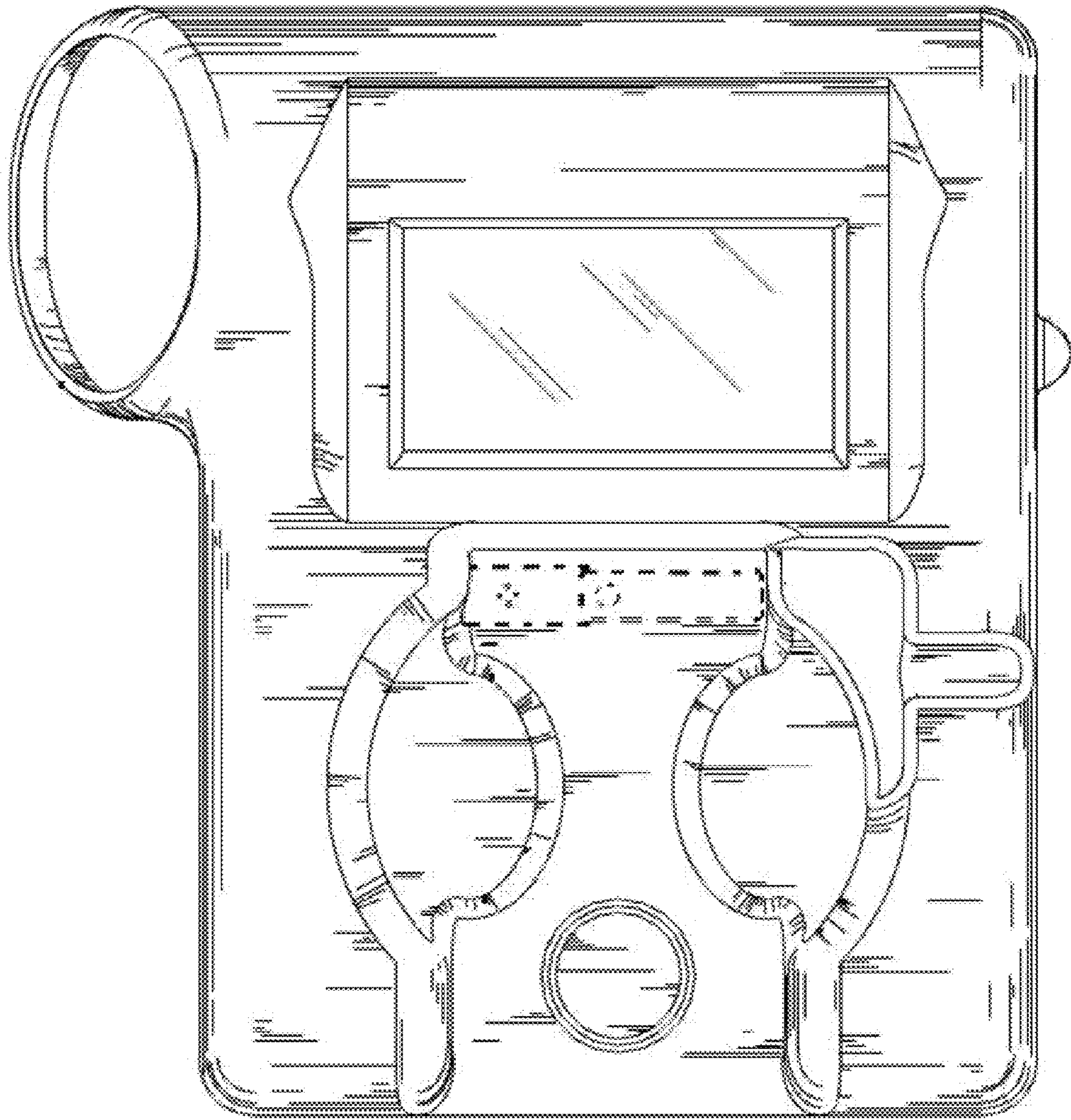

FIG. 6

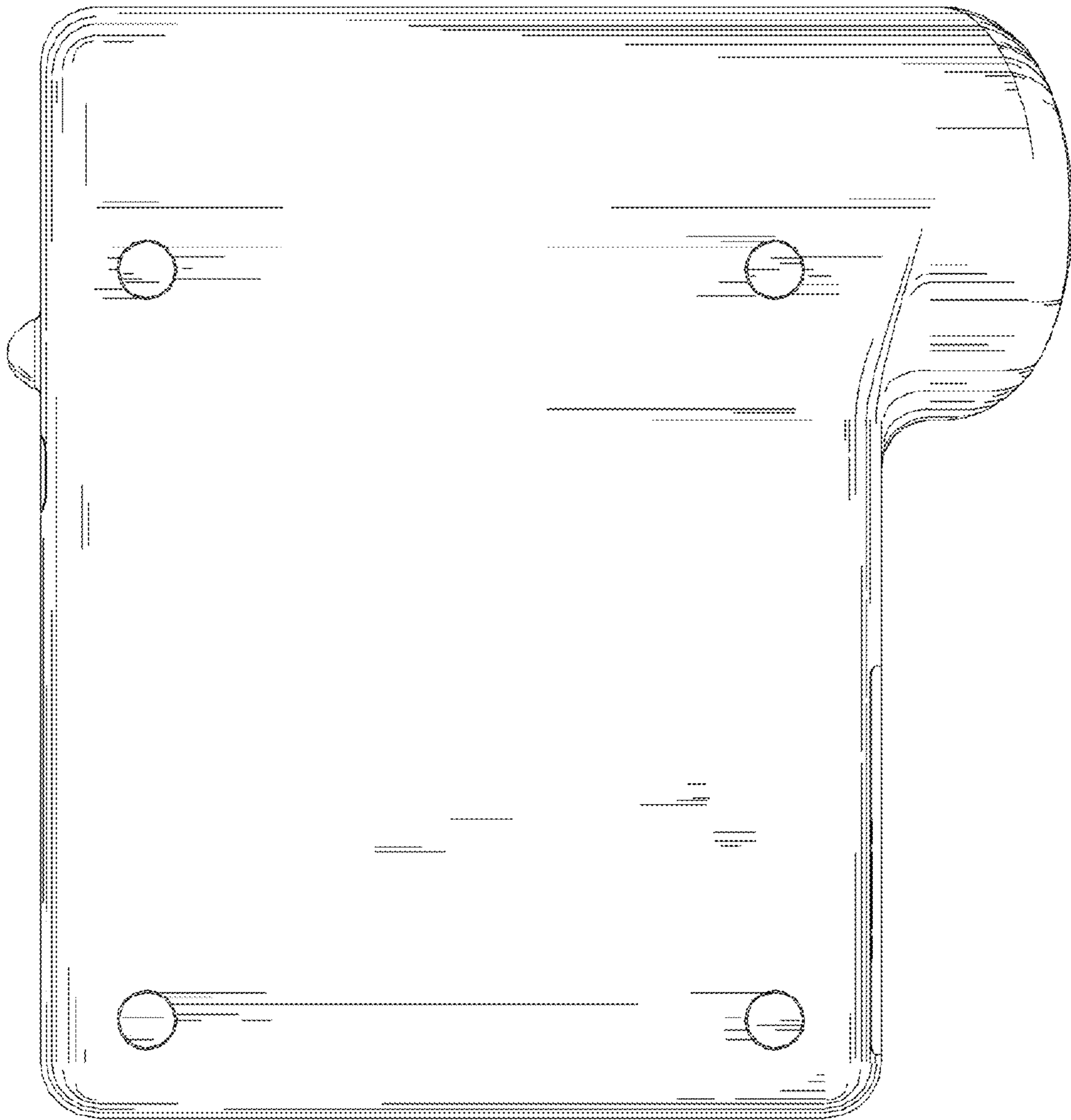

FIG. 7

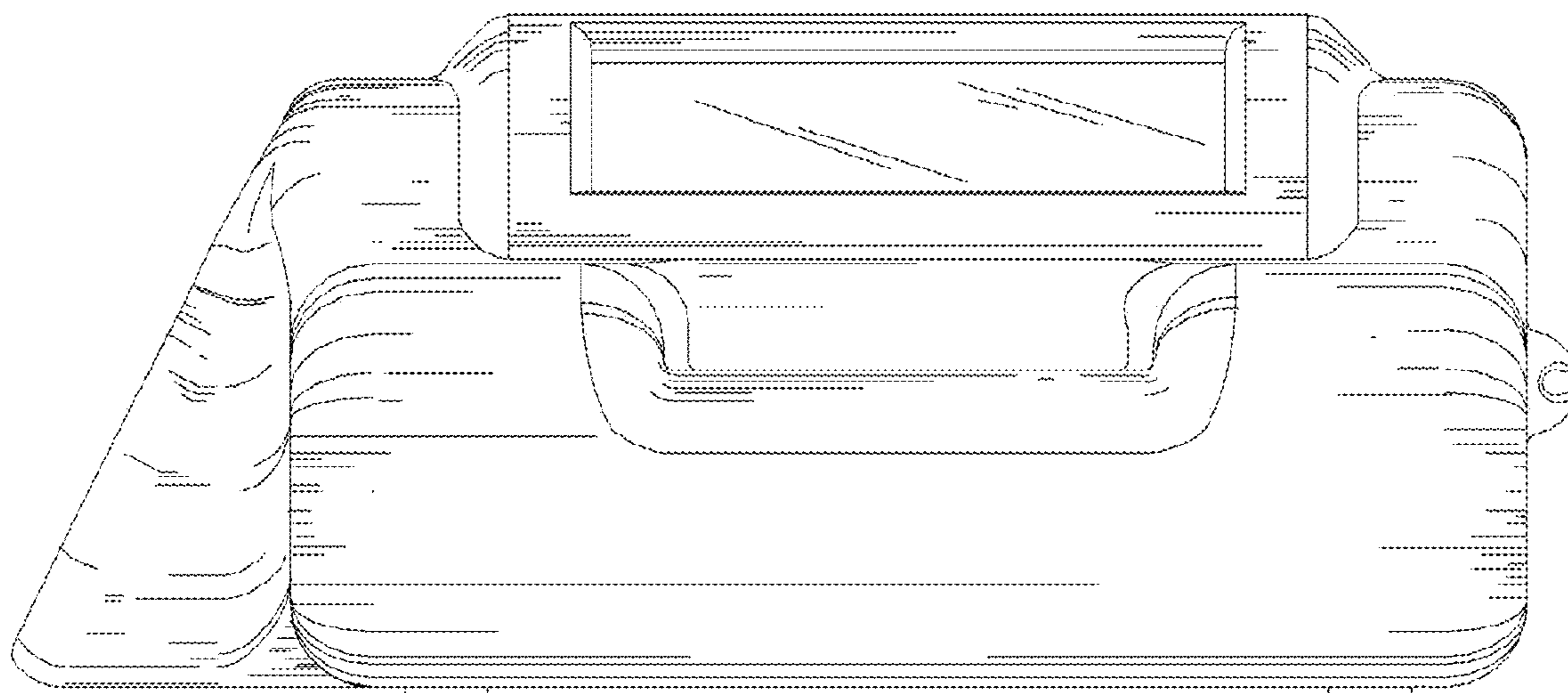

FIG. 8

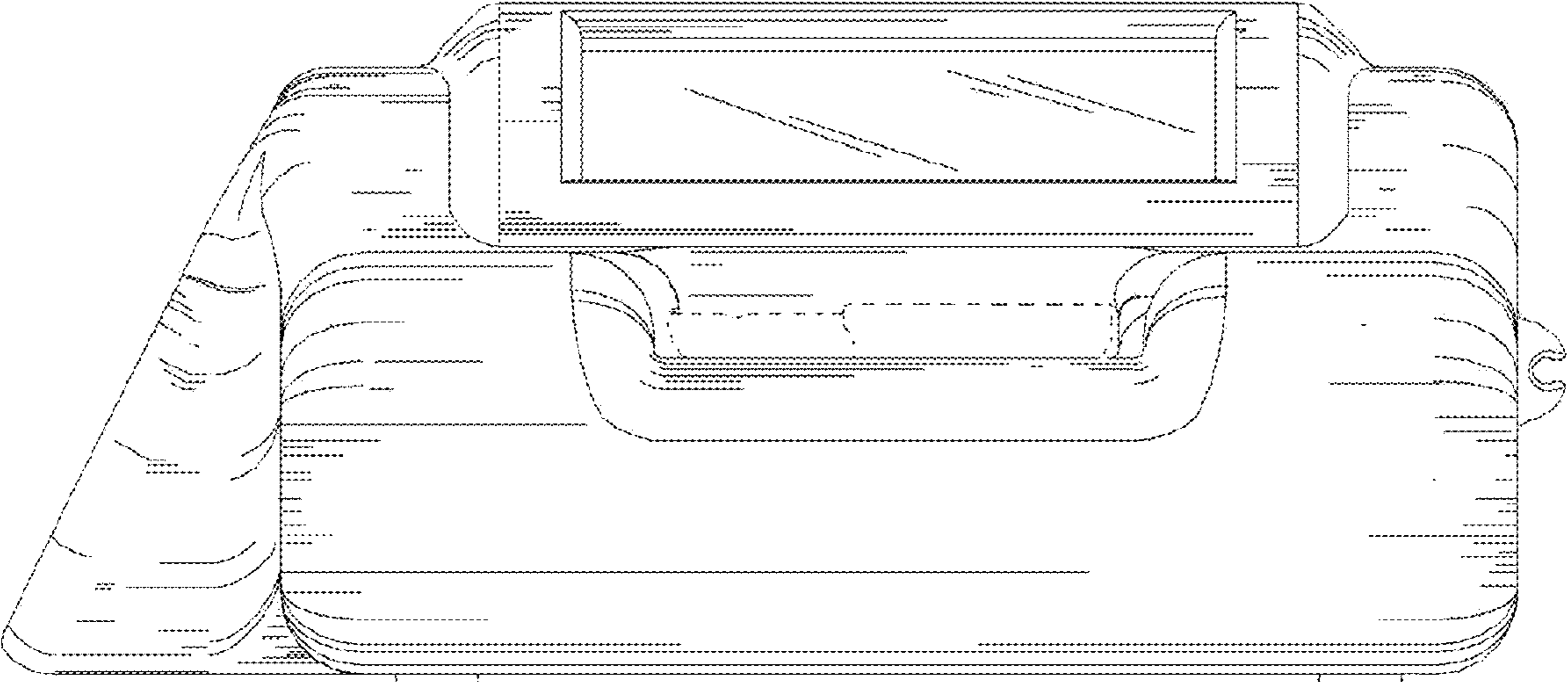

FIG. 9

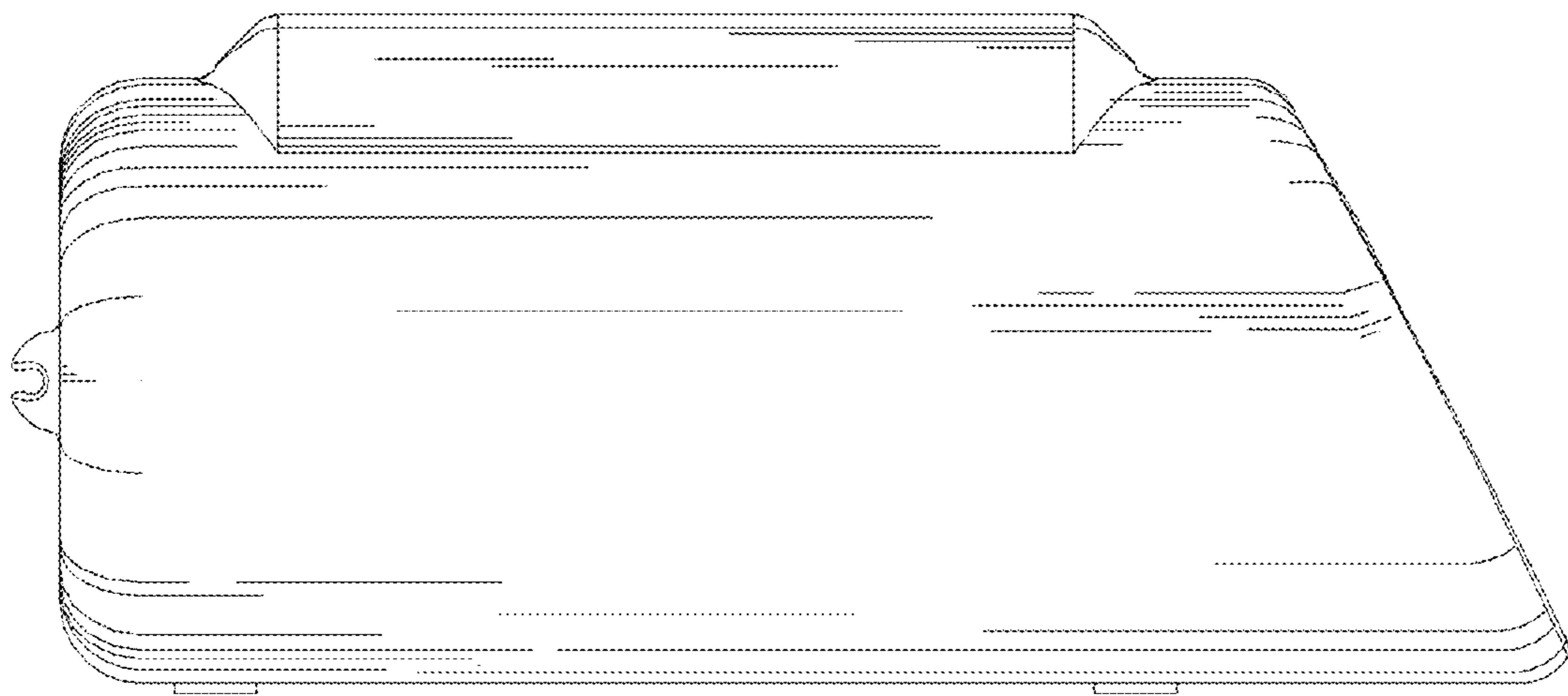

FIG. 10

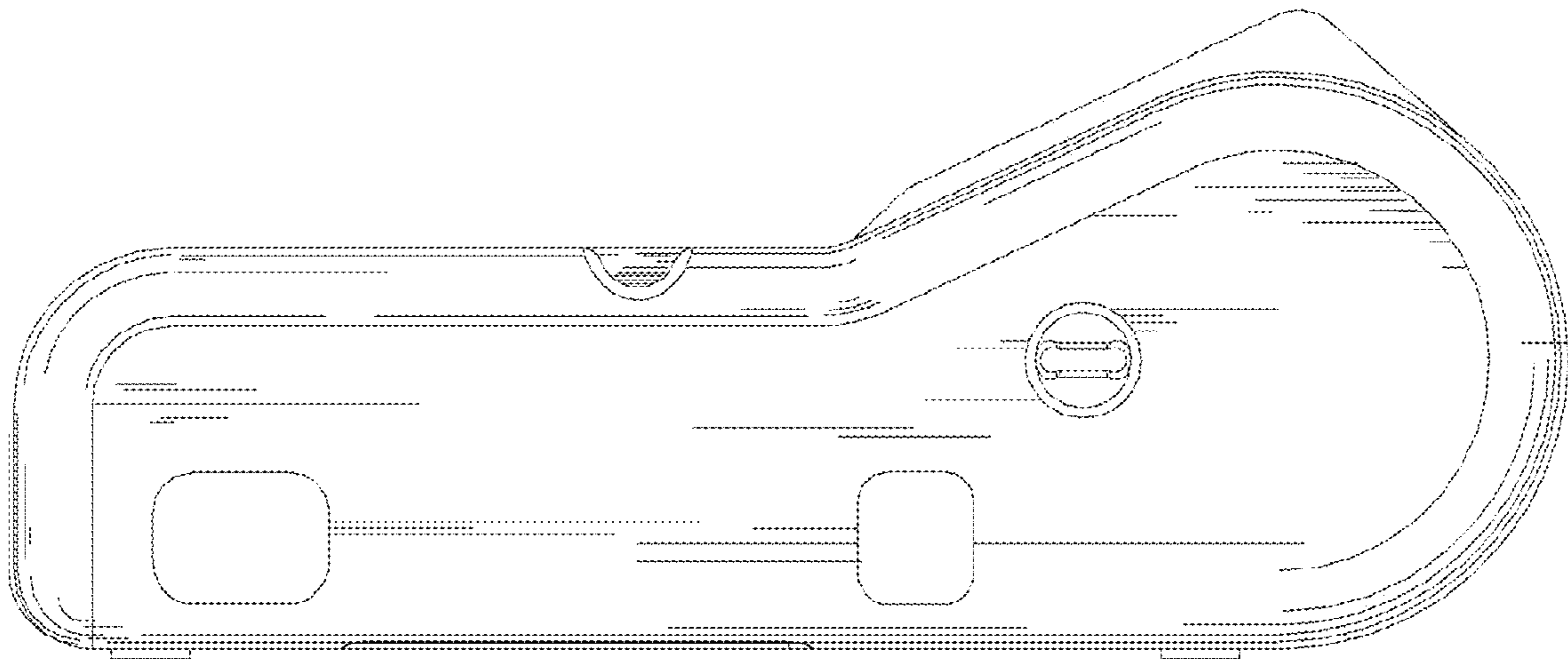

FIG. 11

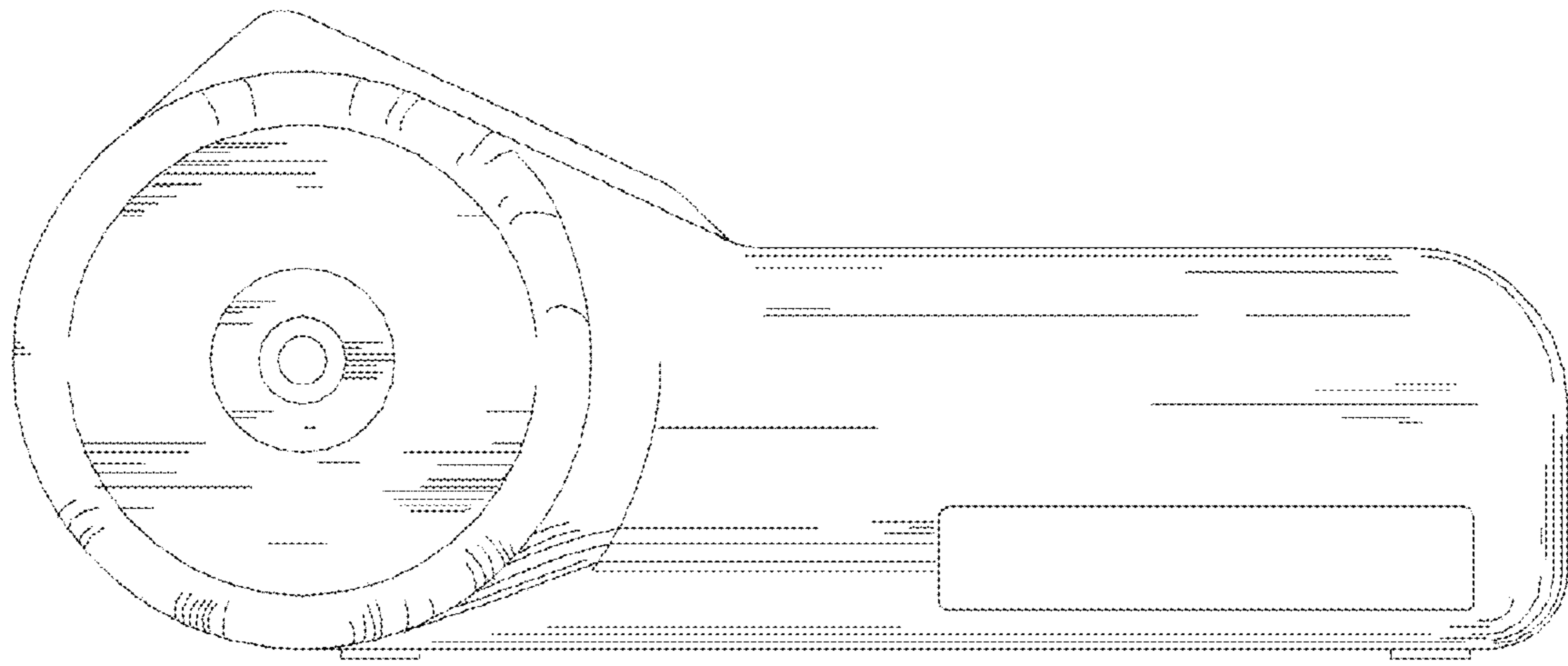

FIG. 12