



US00D692779S

(12) **United States Design Patent**  
**Dolce et al.**

(10) **Patent No.:** **US D692,779 S**

(45) **Date of Patent:** **\*\* Nov. 5, 2013**

(54) **WRIST WATCH**

(71) Applicant: **Dolce & Gabbana S.r.l.**, Milan (IT)

(72) Inventors: **Domenico Dolce**, Milan (IT); **Stefano Gabbana**, Milan (IT)

(73) Assignee: **Dolce & Gabbana S.R.L.**, Milan (IT)

(\*\*) Term: **14 Years**

(21) Appl. No.: **29/435,572**

(22) Filed: **Oct. 25, 2012**

(30) **Foreign Application Priority Data**

Apr. 26, 2012 (EP) ..... 002033126

(51) **LOC (9) Cl.** ..... **10-02**

(52) **U.S. Cl.**  
USPC ..... **D10/39**

(58) **Field of Classification Search**  
USPC ..... D10/30-39, 122-132; 368/276, 281,  
368/282, 223, 228, 232

See application file for complete search history.

(56) **References Cited**

**U.S. PATENT DOCUMENTS**

D129,370 S *	9/1941	Dupertuis	.....	D10/125
D150,628 S *	8/1948	Goodkind	.....	D10/125
D159,306 S *	7/1950	Warren	.....	D10/39
D227,926 S *	7/1973	Kohler	.....	D10/39
D234,943 S *	4/1975	Marquand	.....	D10/39
D325,351 S *	4/1992	Alberti	.....	D10/30
D328,866 S *	8/1992	Deleskiewicz	.....	D10/39
D340,414 S *	10/1993	DeGraeve	.....	D10/39
D348,615 S *	7/1994	Bernard	.....	D10/39
5,400,304 A *	3/1995	Offenstein	.....	368/285
D371,077 S *	6/1996	Terashima	.....	D10/30
D399,159 S *	10/1998	Pandel	.....	D10/128

D412,446 S *	8/1999	Tse	.....	D10/32
D436,319 S *	1/2001	Giardiello	.....	D10/39
D539,176 S *	3/2007	Lillegard et al.	.....	D10/39
D545,222 S *	6/2007	Parmigiani	.....	D10/38
D569,276 S *	5/2008	Scheufele	.....	D10/39
D587,140 S *	2/2009	Kauffmann	.....	D10/38
D588,472 S *	3/2009	Messmer et al.	.....	D10/32
D593,877 S *	6/2009	Jorst et al.	.....	D10/32
D596,959 S *	7/2009	Rousseau	.....	D10/38
D617,213 S *	6/2010	Dolce et al.	.....	D10/38
D624,443 S *	9/2010	Cerrato	.....	D10/38
D632,979 S *	2/2011	Chastaingt	.....	D10/38
D650,704 S *	12/2011	Actis-Datta	.....	D10/32
D650,705 S *	12/2011	Blank	.....	D10/32
D652,744 S *	1/2012	Nandha	.....	D10/39
D671,429 S *	11/2012	Parmigiani	.....	D10/38

\* cited by examiner

*Primary Examiner* — Lucy Lieberman

(74) *Attorney, Agent, or Firm* — Jacobson Holman PLLC

(57) **CLAIM**

The ornamental design for a wrist watch, as shown and described.

**DESCRIPTION**

FIG. 1 is a top perspective of the wrist watch embodying our design;

FIG. 2 is a top plan view of FIG. 1;

FIG. 3 is a side elevational view of FIG. 1;

FIG. 4 is a side elevational view of FIG. 1 showing the opposite side of FIG. 3;

FIG. 5 is a side elevational view of FIG. 1 showing the stem;

FIG. 6 is a side elevational view of FIG. 1 showing the opposite side of FIG. 5; and,

FIG. 7 is a bottom plan view of the wrist watch.

The broken lines in the drawings are used to show portions of the wrist watch that do not form part of the claimed design.

**1 Claim, 4 Drawing Sheets**

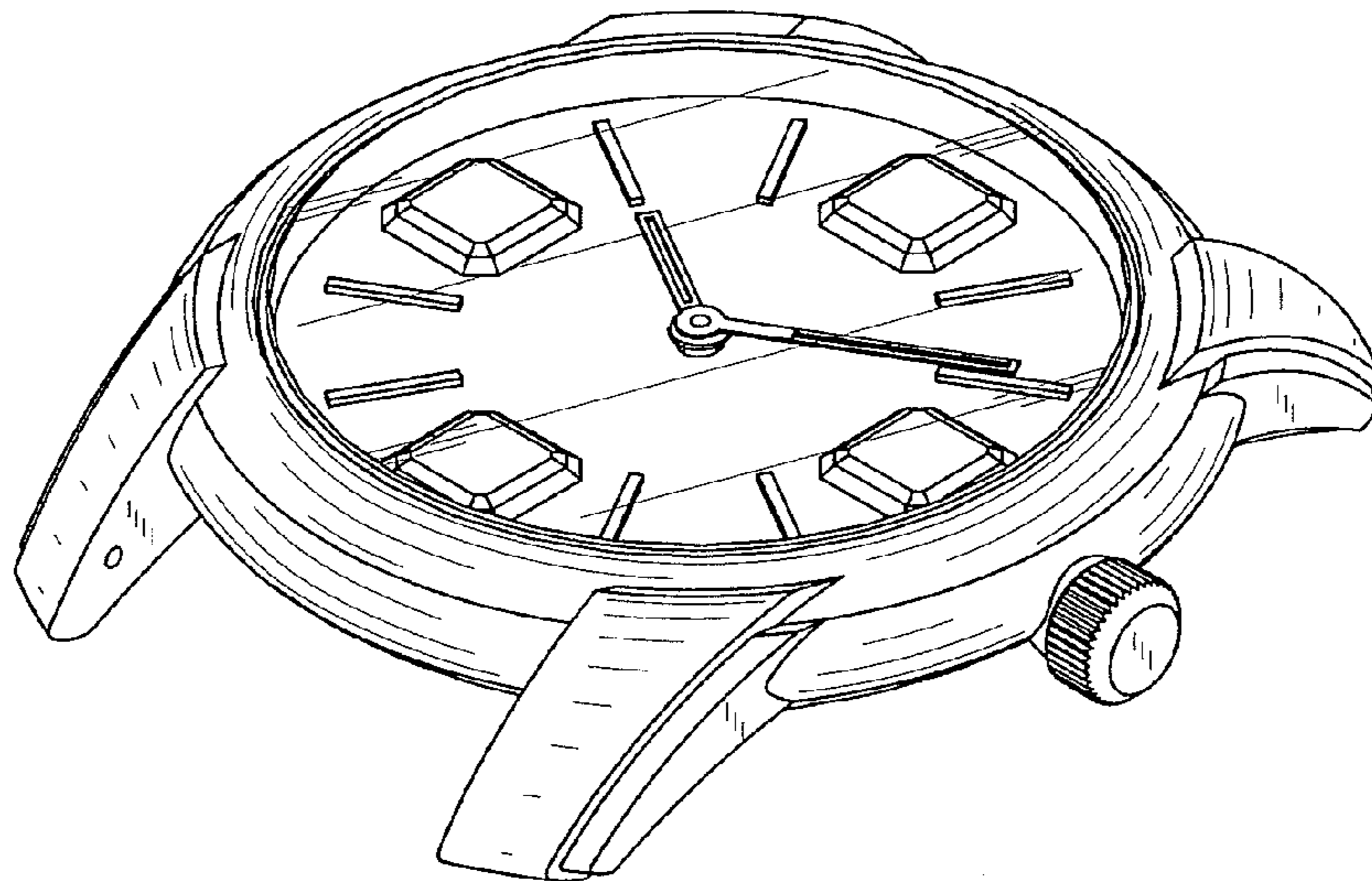

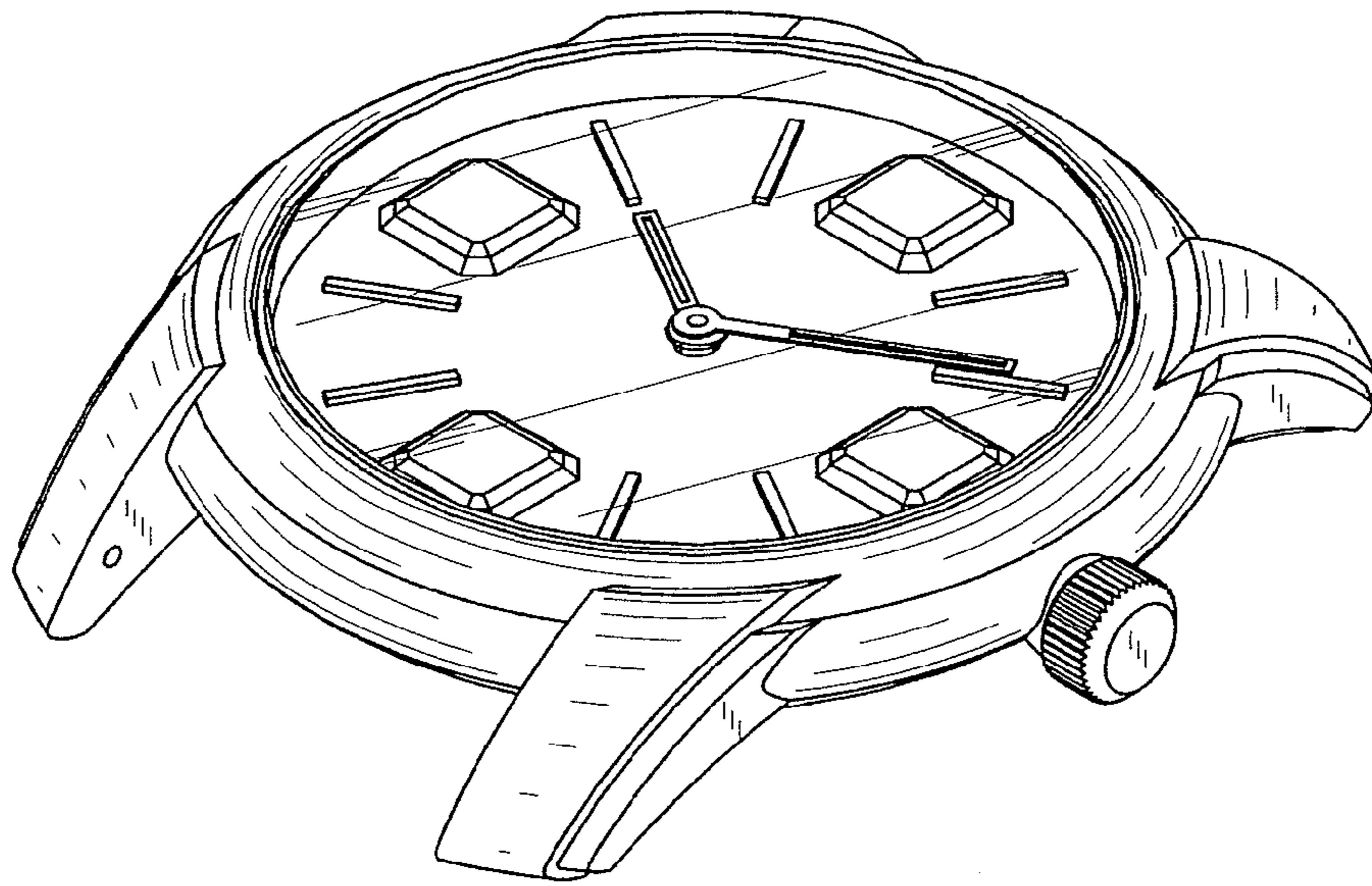

Fig. 1

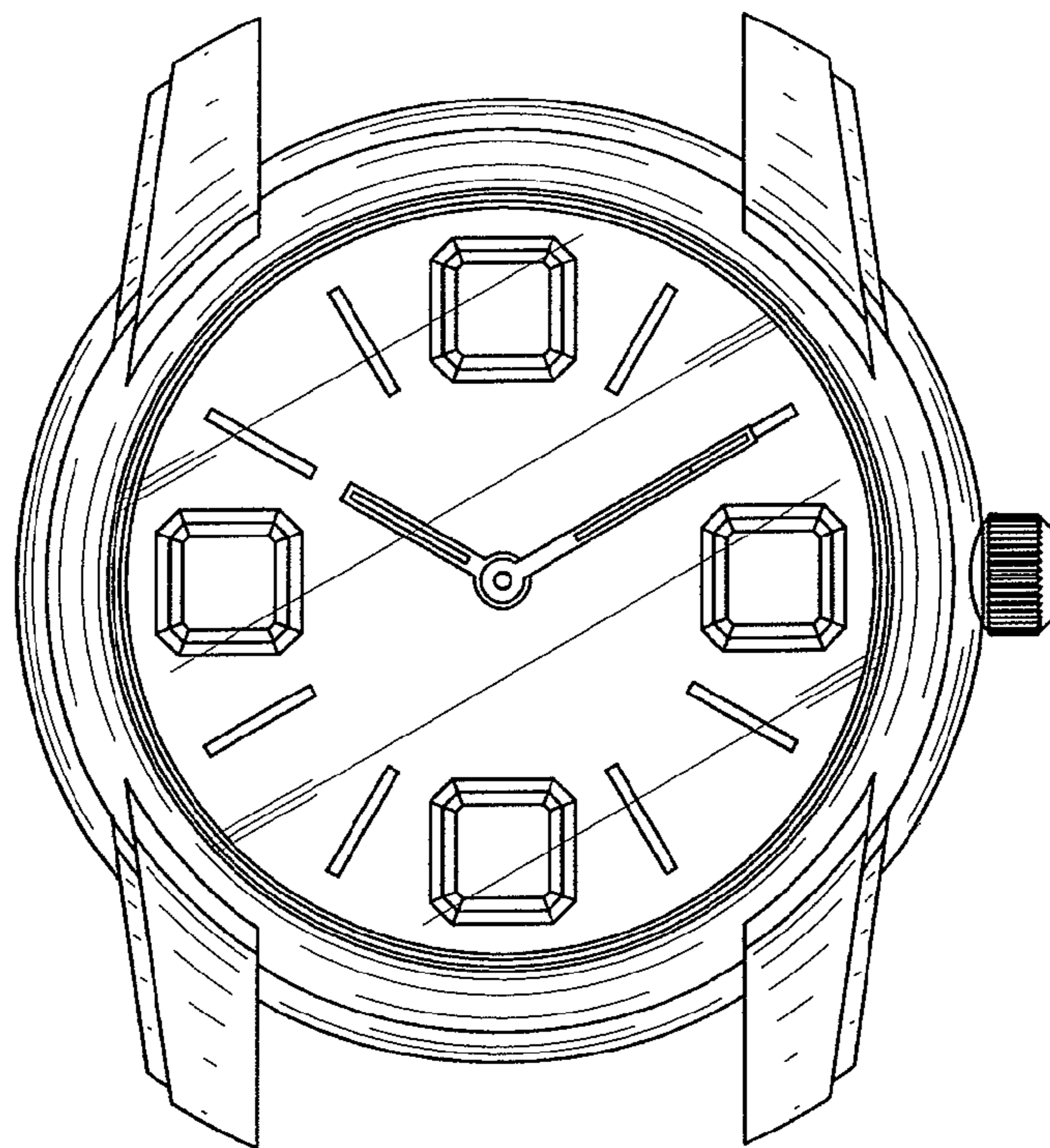

Fig. 2

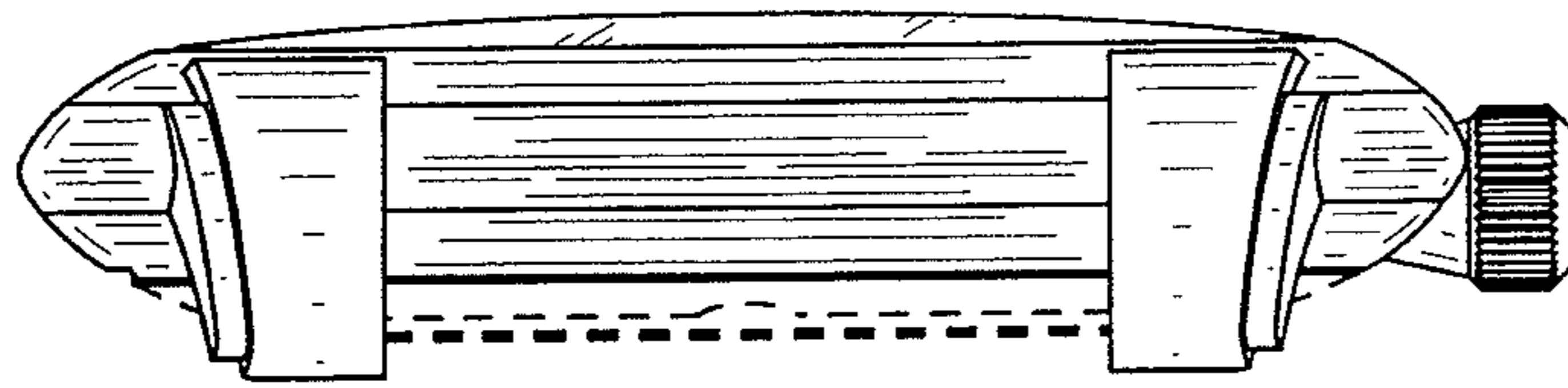

Fig. 3

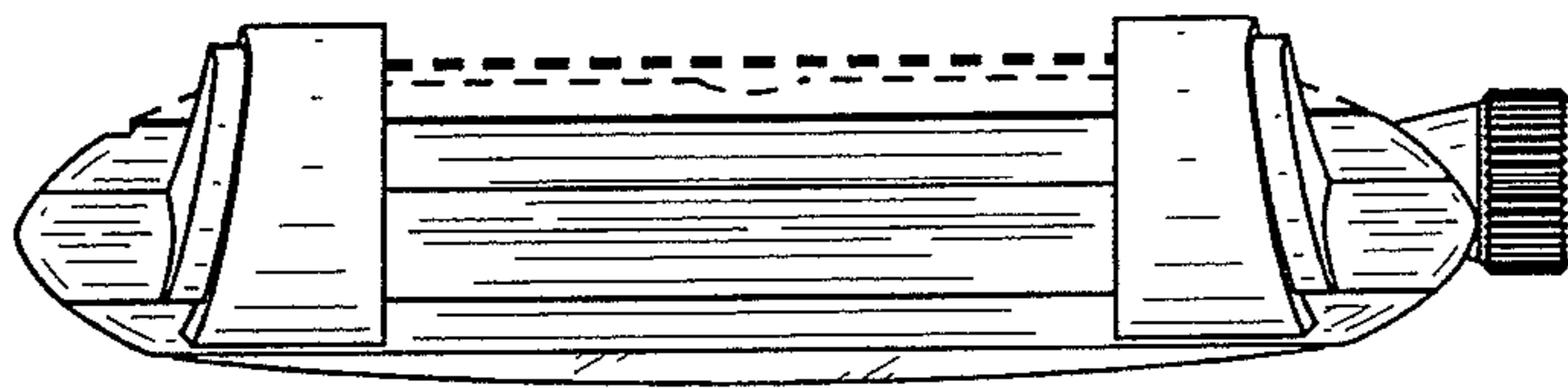

Fig. 4

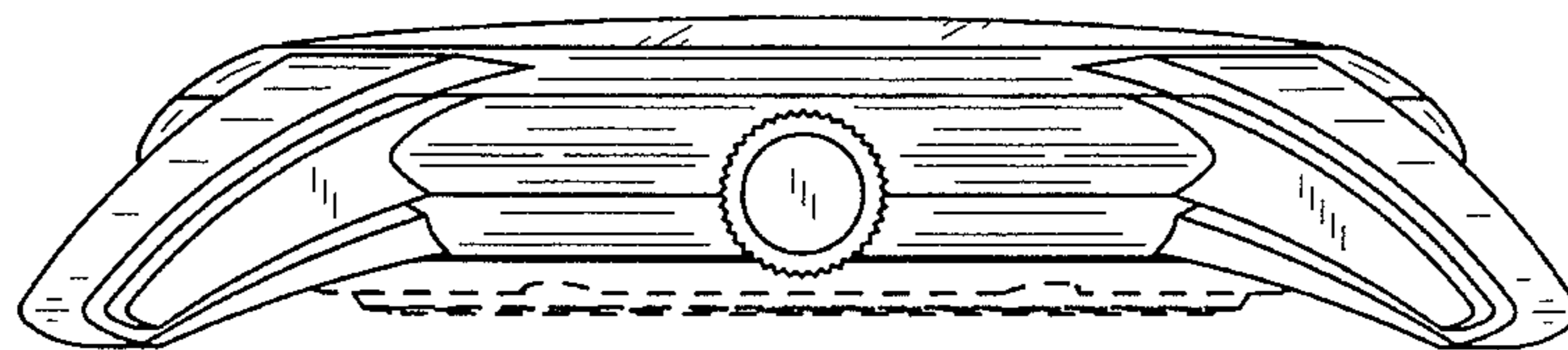

Fig. 5

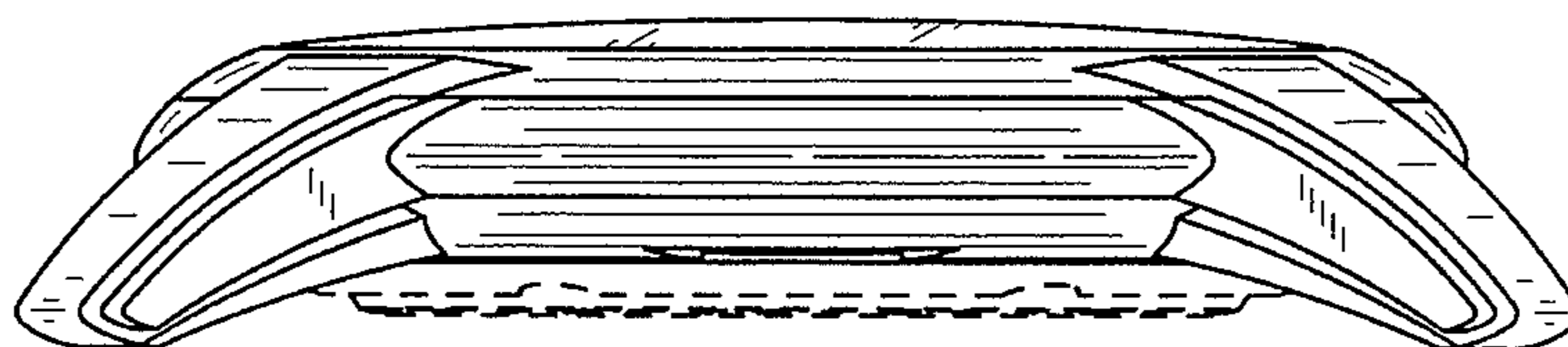

Fig. 6



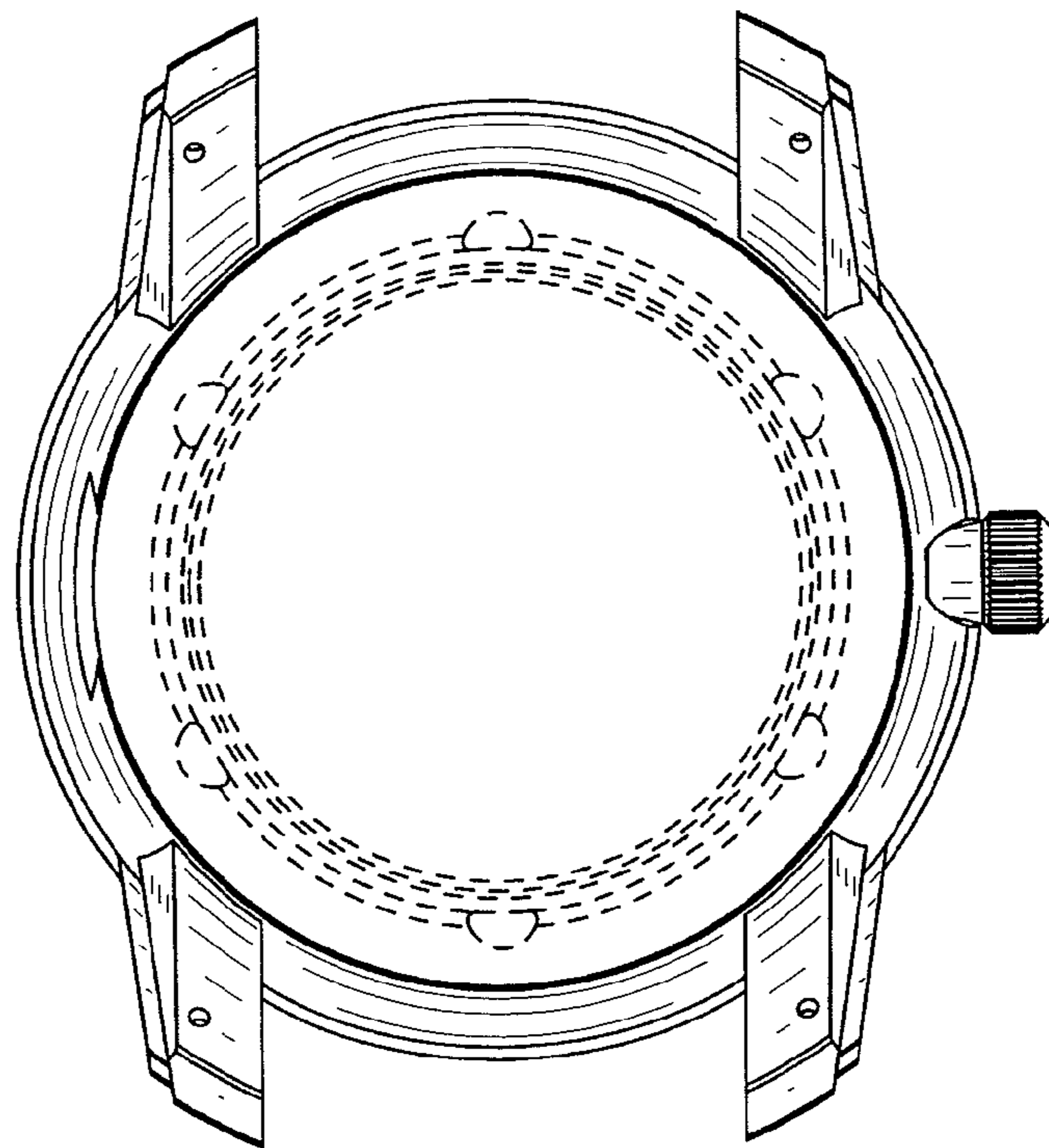

Fig. 7