



US00D692712S

(12) **United States Design Patent**
Helser

(10) **Patent No.:** **US D692,712 S**
(45) **Date of Patent:** **** Nov. 5, 2013**

(54) **MODULAR BED BASE**

D316,939 S * 5/1991 Chambers, Jr. D6/382
D608,560 S * 1/2010 Chen D6/384
D663,077 S * 7/2012 Pohl D30/118

(75) Inventor: **Chris Helser**, Surrey (CA)

* cited by examiner

(73) Assignee: **Corporate Images Holdings Ltd.**,
Surrey, British Columbia

Primary Examiner — Janice Seeger

(**) Term: **14 Years**

(57) **CLAIM**

(21) Appl. No.: **29/431,442**

The ornamental design for a modular bed base, as shown and described.

(22) Filed: **Sep. 7, 2012**

DESCRIPTION

(51) **LOC (9) Cl.** **06-06**

(52) **U.S. Cl.**
USPC **D6/718; D6/705**

(58) **Field of Classification Search**
USPC D6/382-384, 392-395, 702, 718,
D6/718.14; 5/53.1, 279.1, 280, 281, 907,
5/236.1, 178, 308, 2.1
See application file for complete search history.

FIG. 1 is a left view of a modular bed base showing my new design;
FIG. 2 is a right view thereof;
FIG. 3 is a front view thereof;
FIG. 4 is a rear view thereof; and
FIG. 5 is a top plan view thereof.
FIG. 6 is a bottom plan view thereof; and,
FIG. 7 is a perspective view thereof; the broken lines showing the whole bed base are for environmental purposes only and form no part of the claimed design.
The modular bed base is shown in broken lines for illustrative purposes only, and forms no part of the claimed design.

(56) **References Cited**

U.S. PATENT DOCUMENTS

1,297,144 A * 3/1919 Giordano 5/2.1
2,432,379 A * 12/1947 Butler 5/2.1
D280,475 S * 9/1985 Testa D6/384

1 Claim, 4 Drawing Sheets

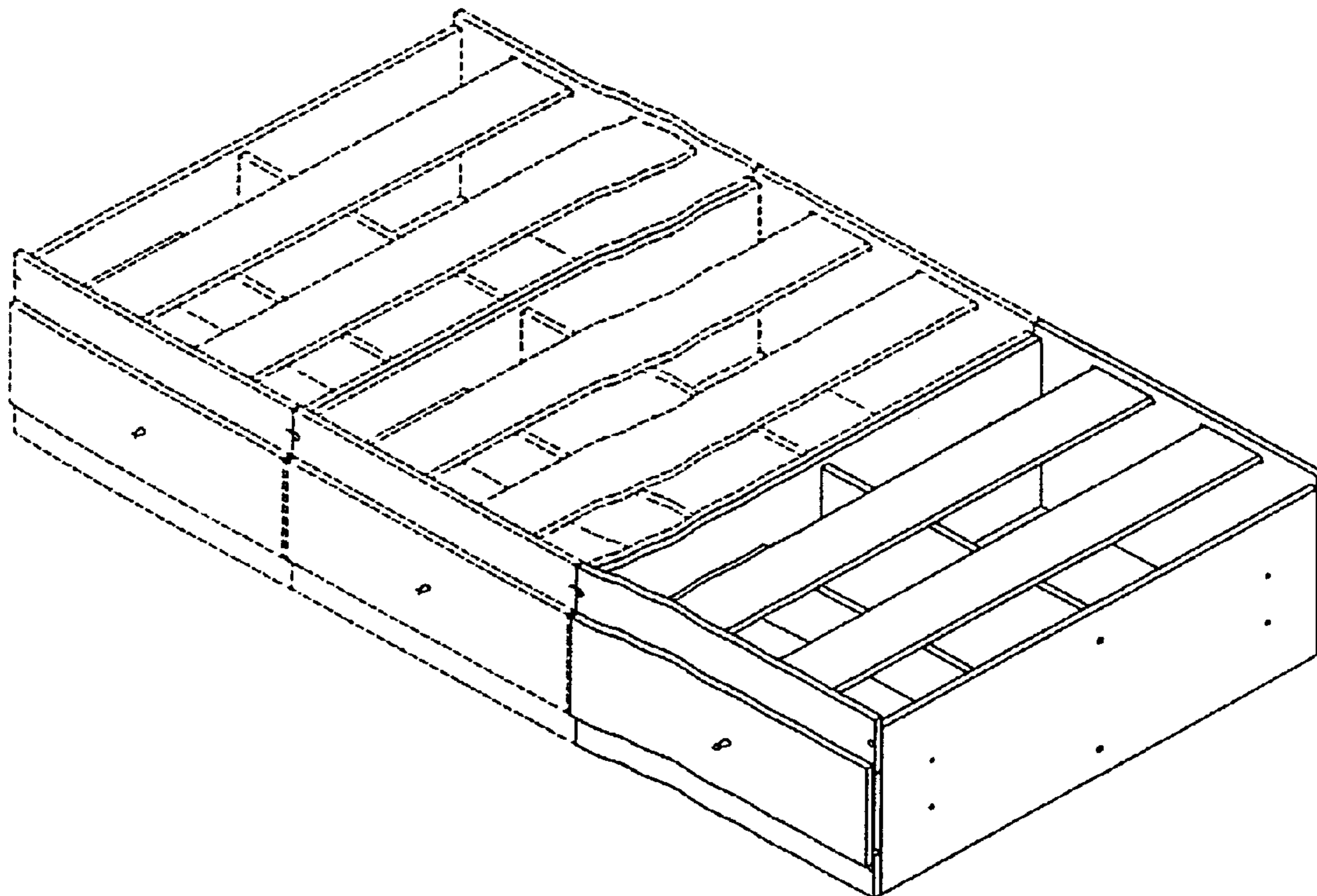

Fig. 1

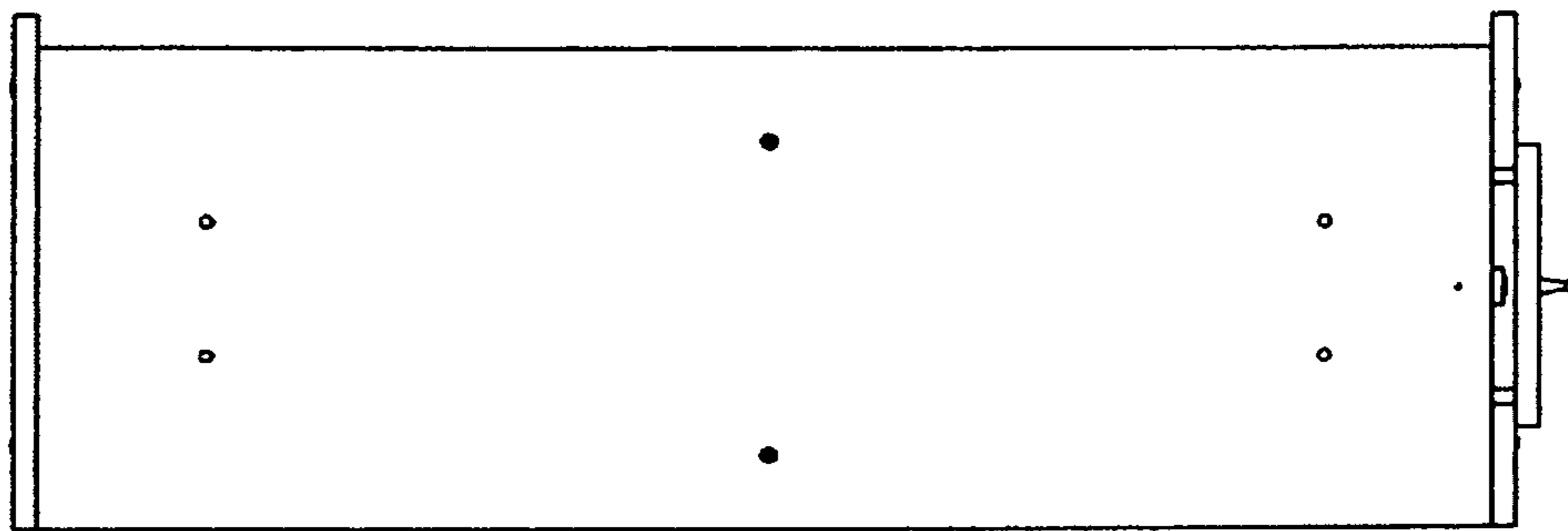

Fig. 2

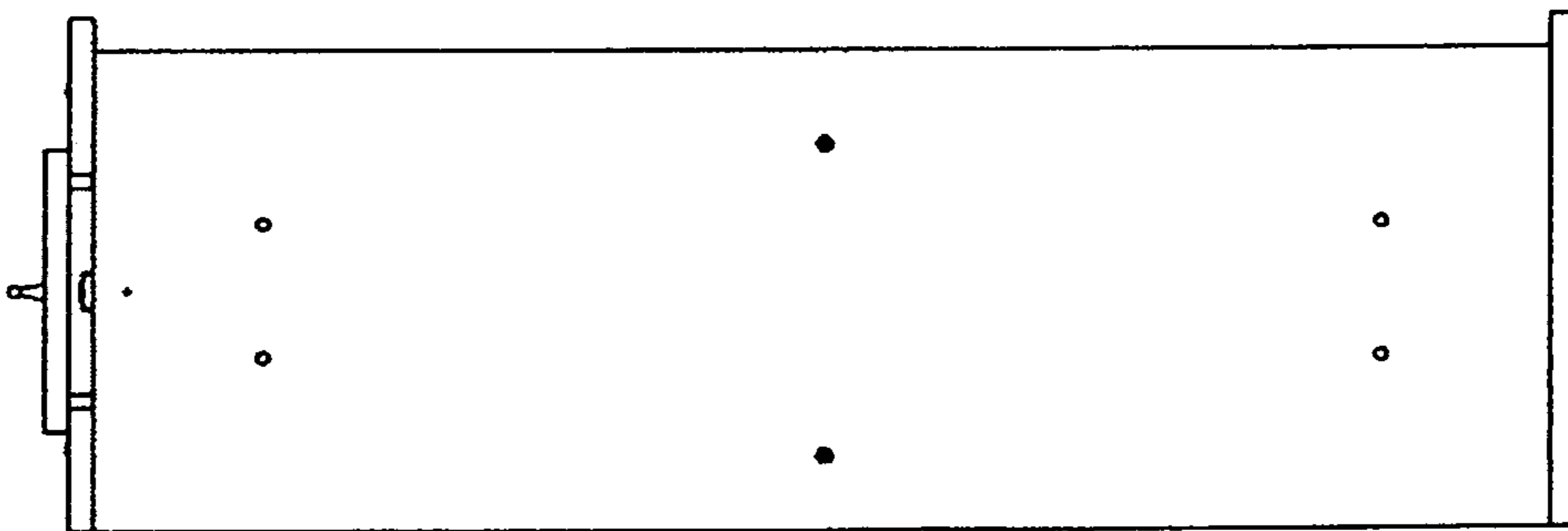

Fig. 3

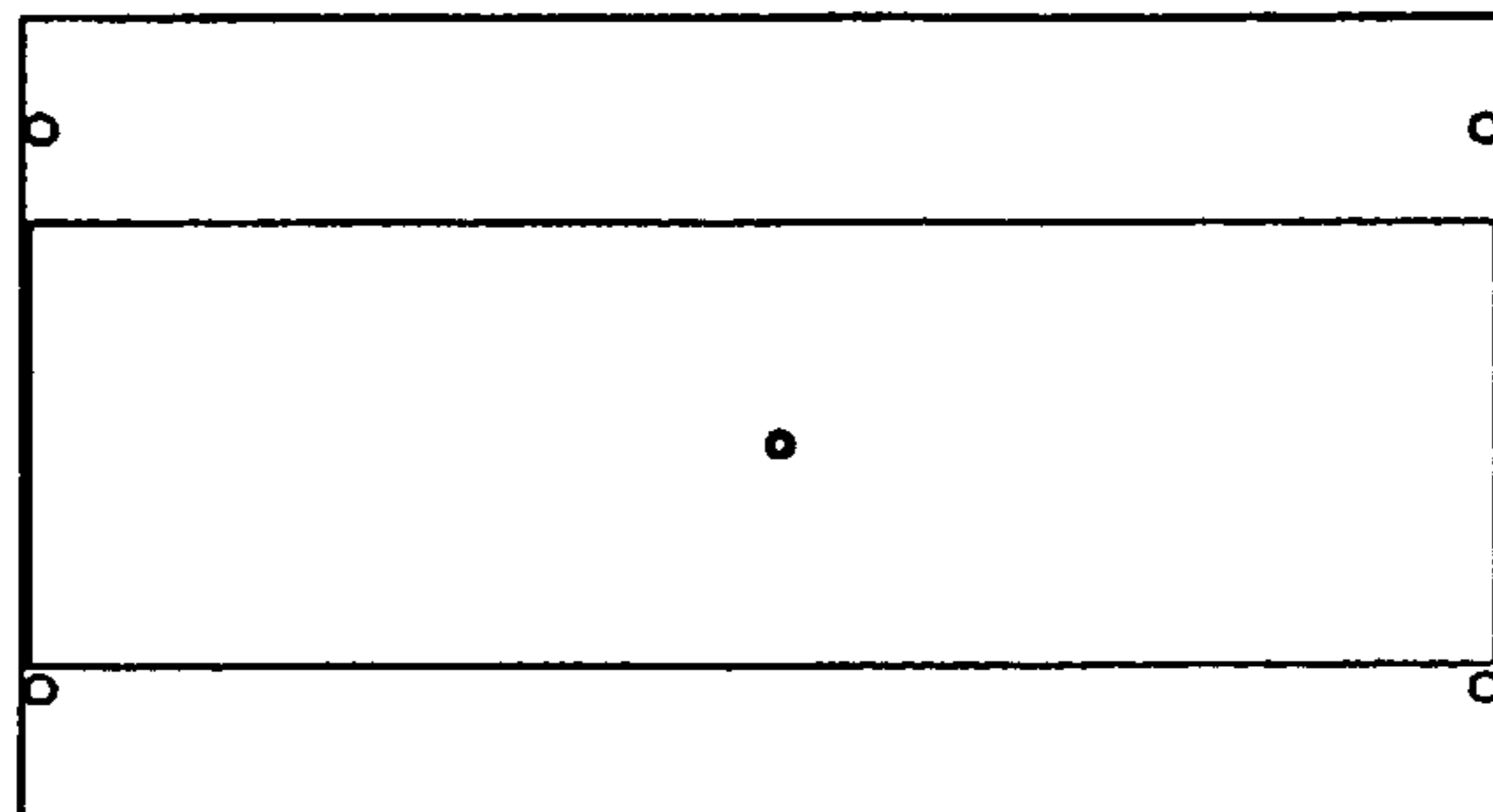

Fig. 4

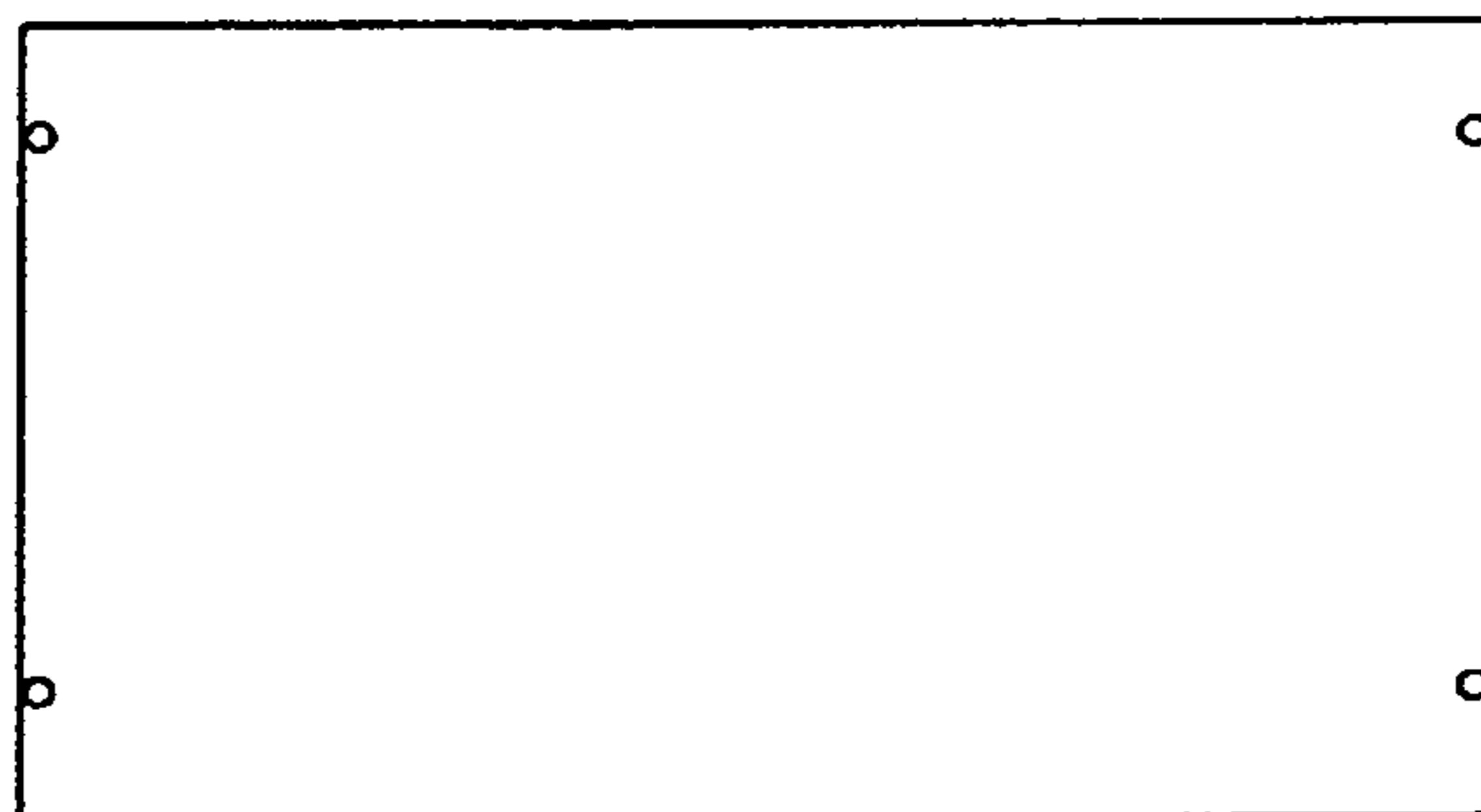

Fig. 5

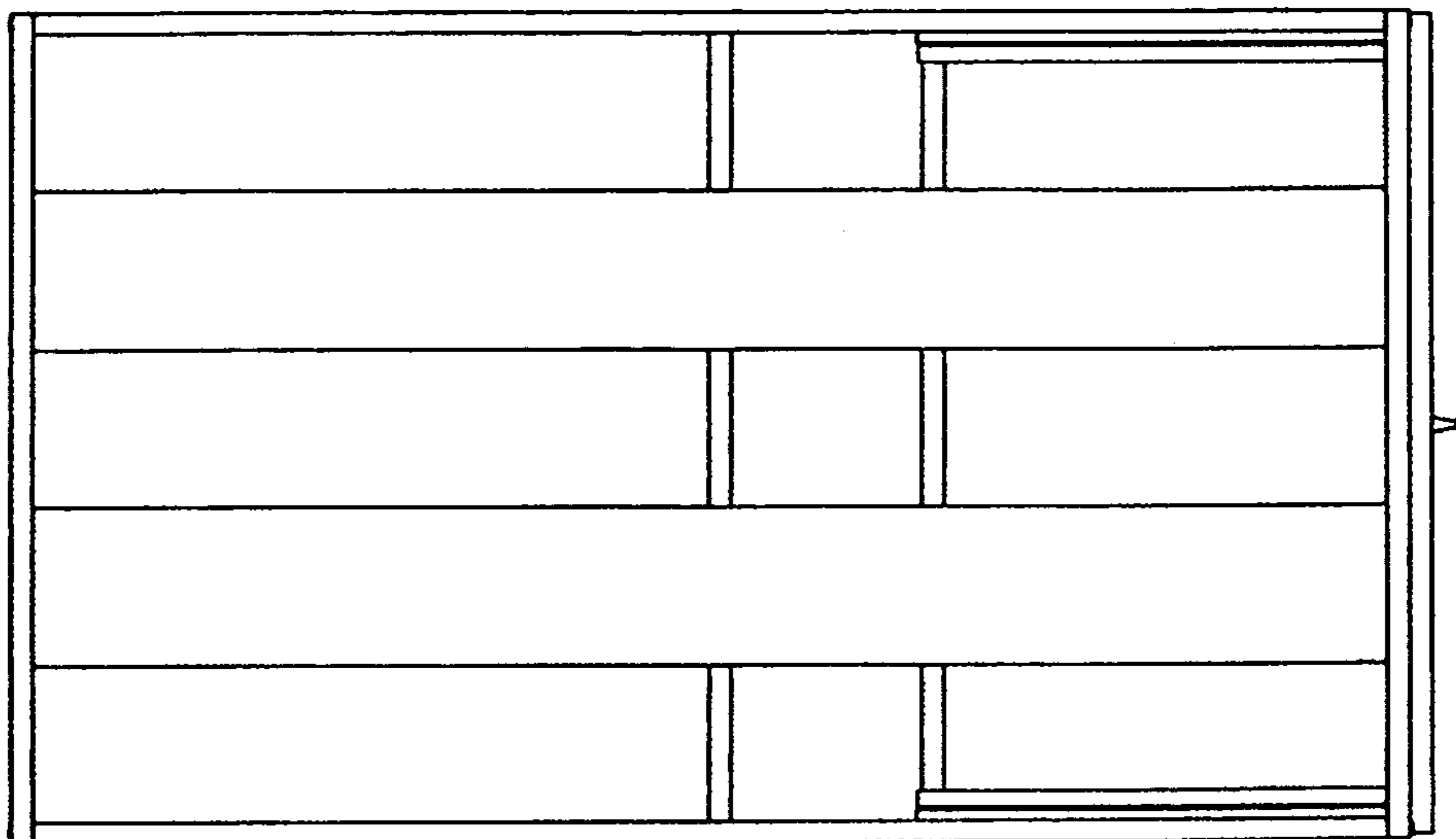

Fig. 6

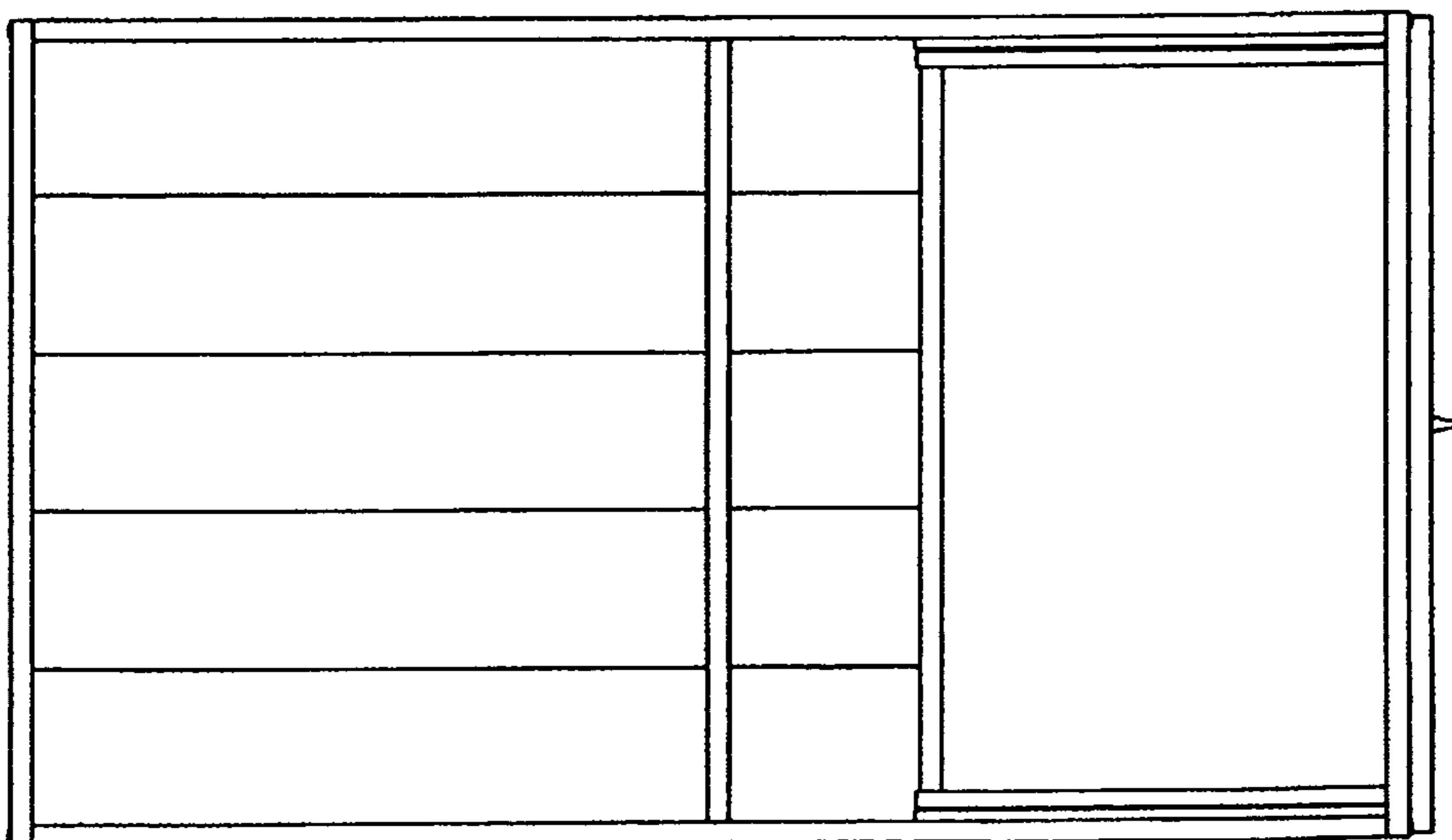

Fig. 7

